



US00D974919S

(12) **United States Design Patent** (10) **Patent No.:** **US D974,919 S**  
**Shiota** (45) **Date of Patent:** **\*\* Jan. 10, 2023**

(54) **TUBE**

(71) Applicant: **Emiko Shiota**, Tokyo (JP)

(72) Inventor: **Emiko Shiota**, Tokyo (JP)

(73) Assignee: **SHISEIDO COMPANY, LIMITED**,  
Tokyo (JP)

(\*\*) Term: **15 Years**

(21) Appl. No.: **29/801,981**

(22) Filed: **Aug. 2, 2021**

(51) **LOC (14) Cl.** ..... **09-05**

(52) **U.S. Cl.**  
USPC ..... **D9/697**

(58) **Field of Classification Search**  
USPC ..... D9/702-714, 695-699, 435, 440, 521,  
D9/454, 544, 723-724, 499, 449,  
D9/727-728, 442, 447, 504; D28/91.1,  
D28/76-78, 82, 88; D4/114; D24/114;  
D7/601-602; D3/202, 205  
CPC ..... B65D 35/00; B65D 35/28; B65D 35/02;  
B65D 35/04; B65D 35/08; B65D 35/36;  
B65D 35/38; B65D 5/00; B65D 5/001;  
B65D 5/0227; B65D 5/0254; B65D  
5/0045; B65D 5/18; B65D 5/2033; B65D  
5/38; B65D 1/32; B65D 1/00; B65D  
1/22; B65D 1/24; B65D 1/34; B65D 1/38  
See application file for complete search history.

(56) **References Cited**

U.S. PATENT DOCUMENTS

D821,222 S *	6/2018	Kim	.....	D9/697
D826,729 S *	8/2018	Kim	.....	D9/697
D933,490 S *	10/2021	Marotti	.....	D9/697
D952,469 S *	5/2022	Marotti	.....	D9/697
D962,780 S *	9/2022	Davis	.....	D9/697

\* cited by examiner

*Primary Examiner* — Abraham Bahta

(74) *Attorney, Agent, or Firm* — Manabu Kanesaka

(57) **CLAIM**

The ornamental design for a tube, as shown and described.

**DESCRIPTION**

FIG. 1 is a perspective view of a tube showing my new design;

FIG. 2 is a front view thereof, a rear view being symmetrical to the front view;

FIG. 3 is a right side view thereof, left side view being symmetrical to the right side view;

FIG. 4 is a plan view thereof;

FIG. 5 is a bottom view thereof;

FIG. 6 is a front view of a main body, wherein the lid is removed; and,

FIG. 7 is a cross-sectional view thereof along the line 7-7 in FIG. 2.

The broken lines depict portions of the tube that form no part of claimed design.

**1 Claim, 2 Drawing Sheets**

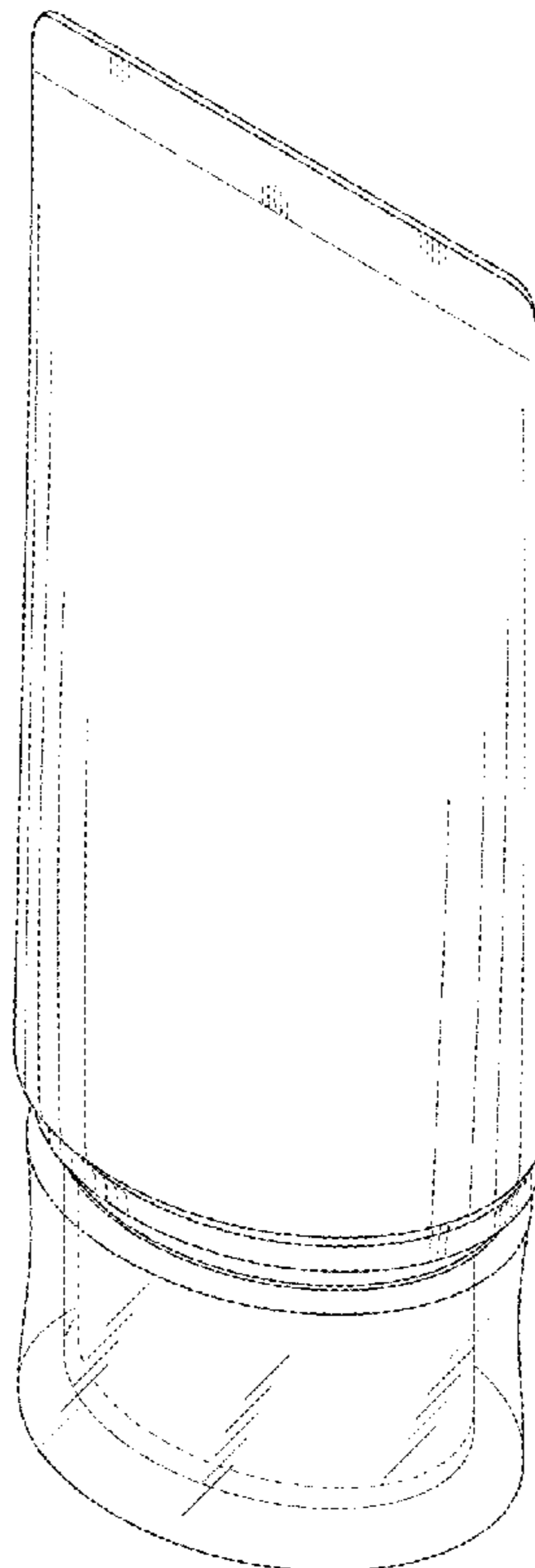

Fig.1

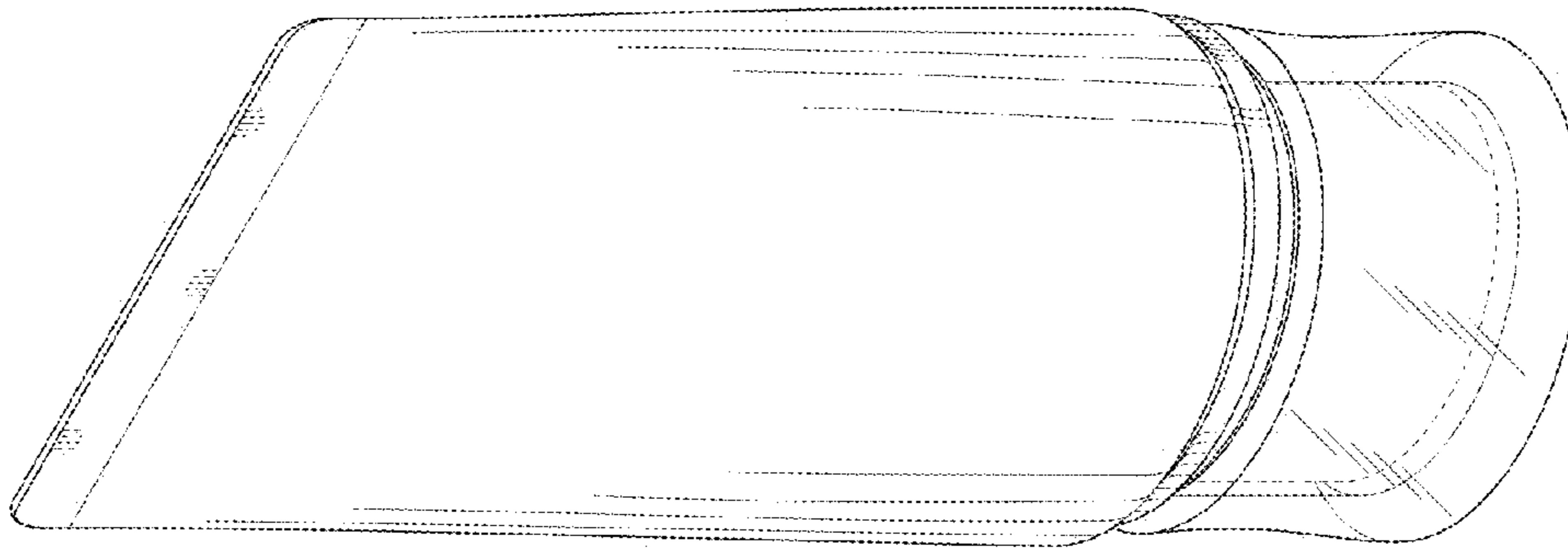

Fig.2

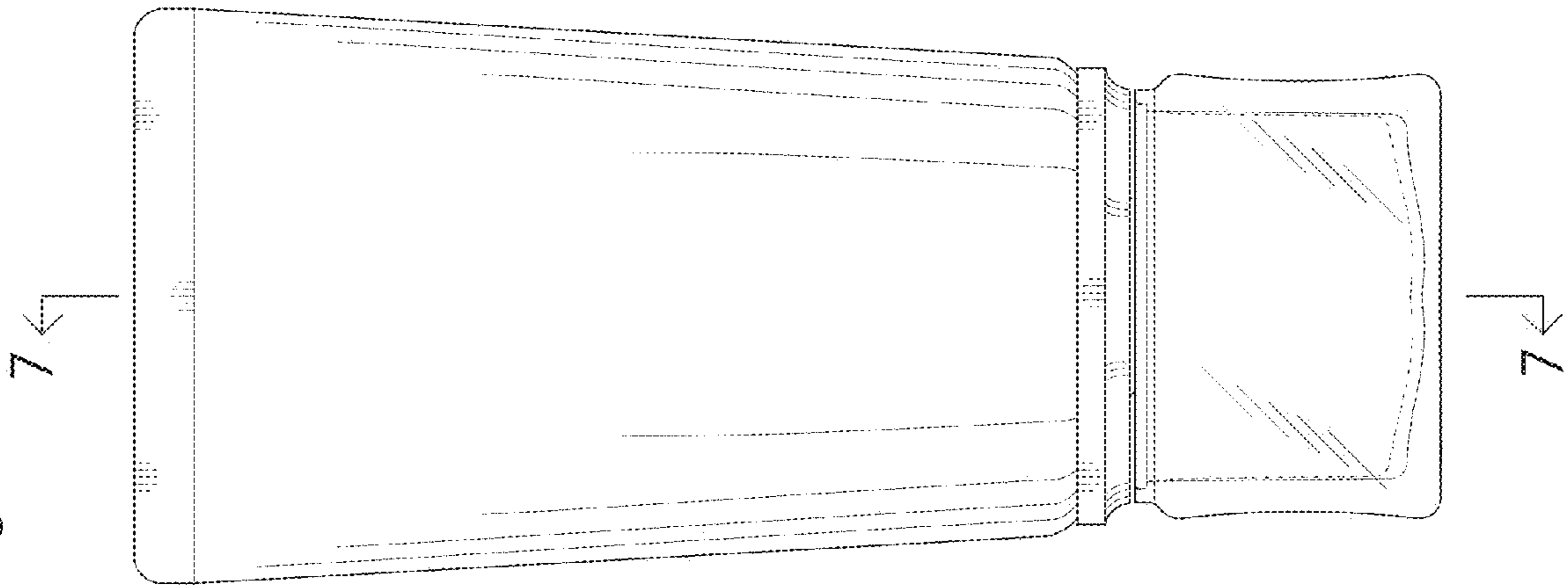

Fig.3

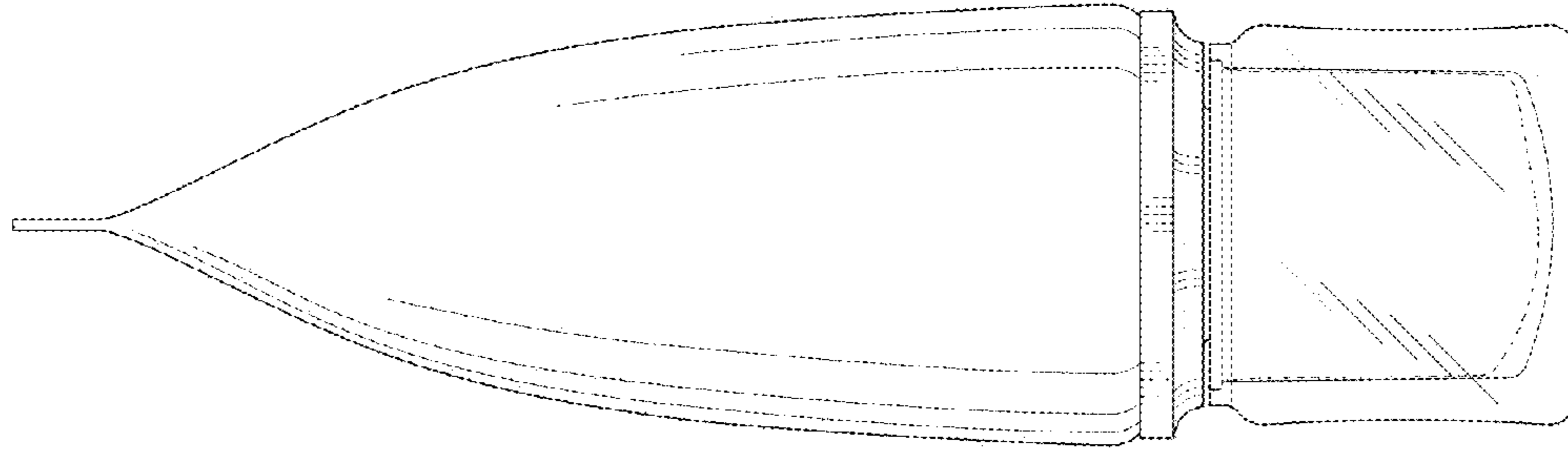

Fig.7

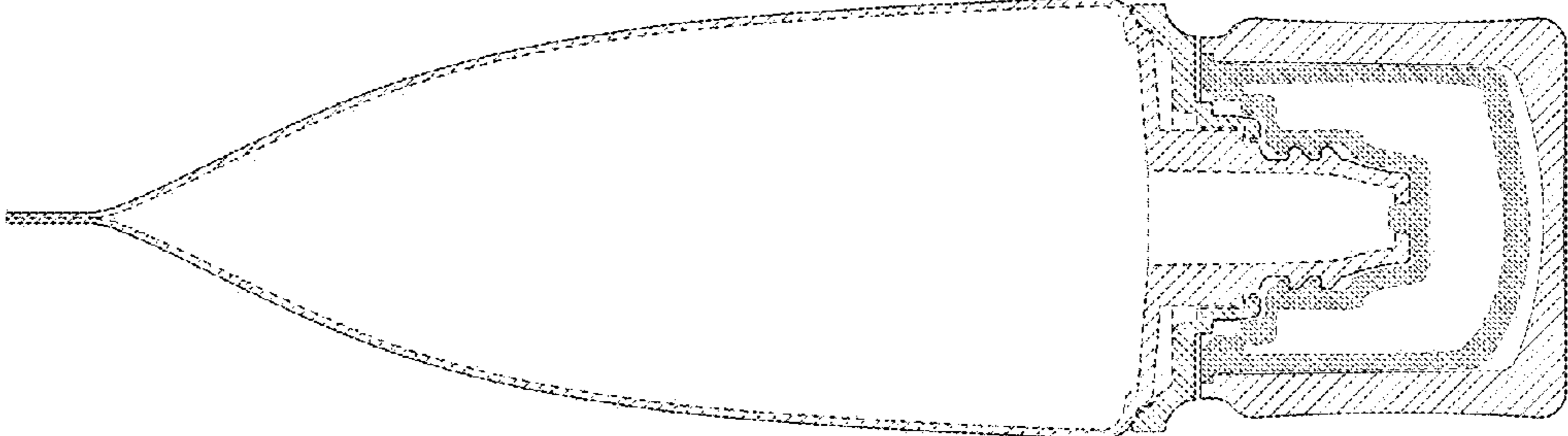

Fig.6

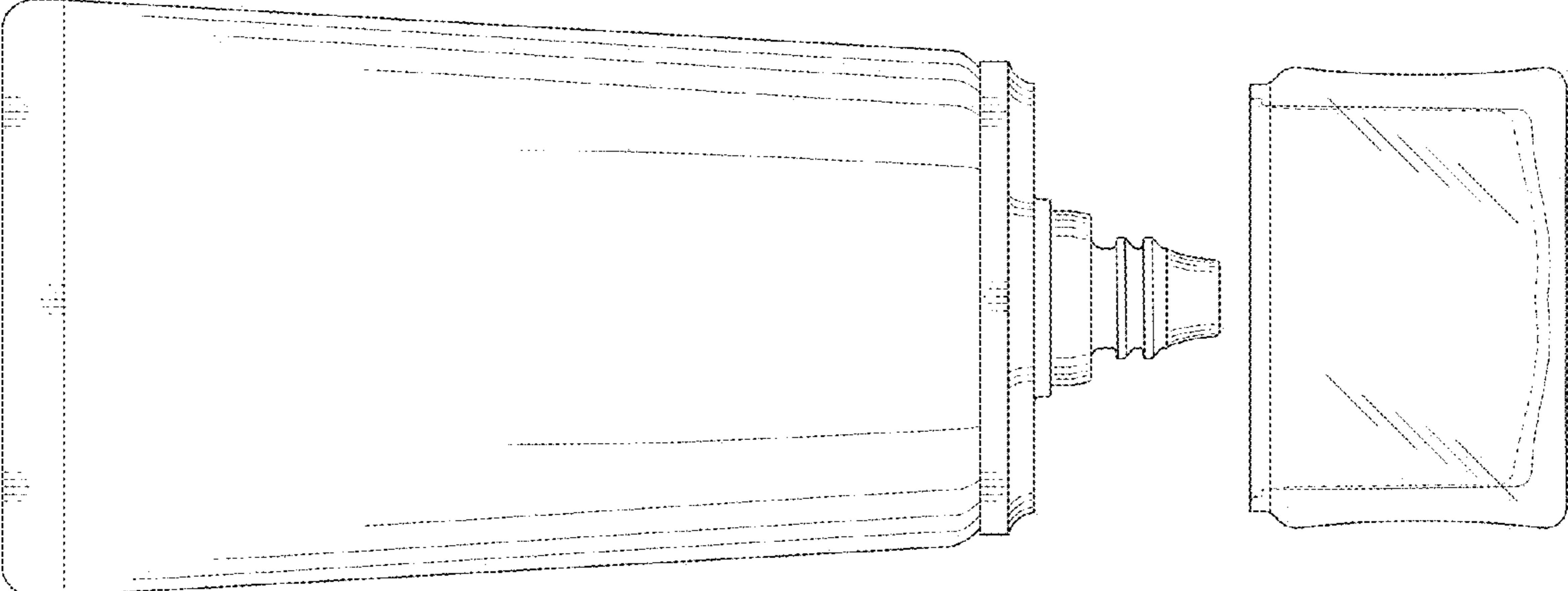

Fig.4

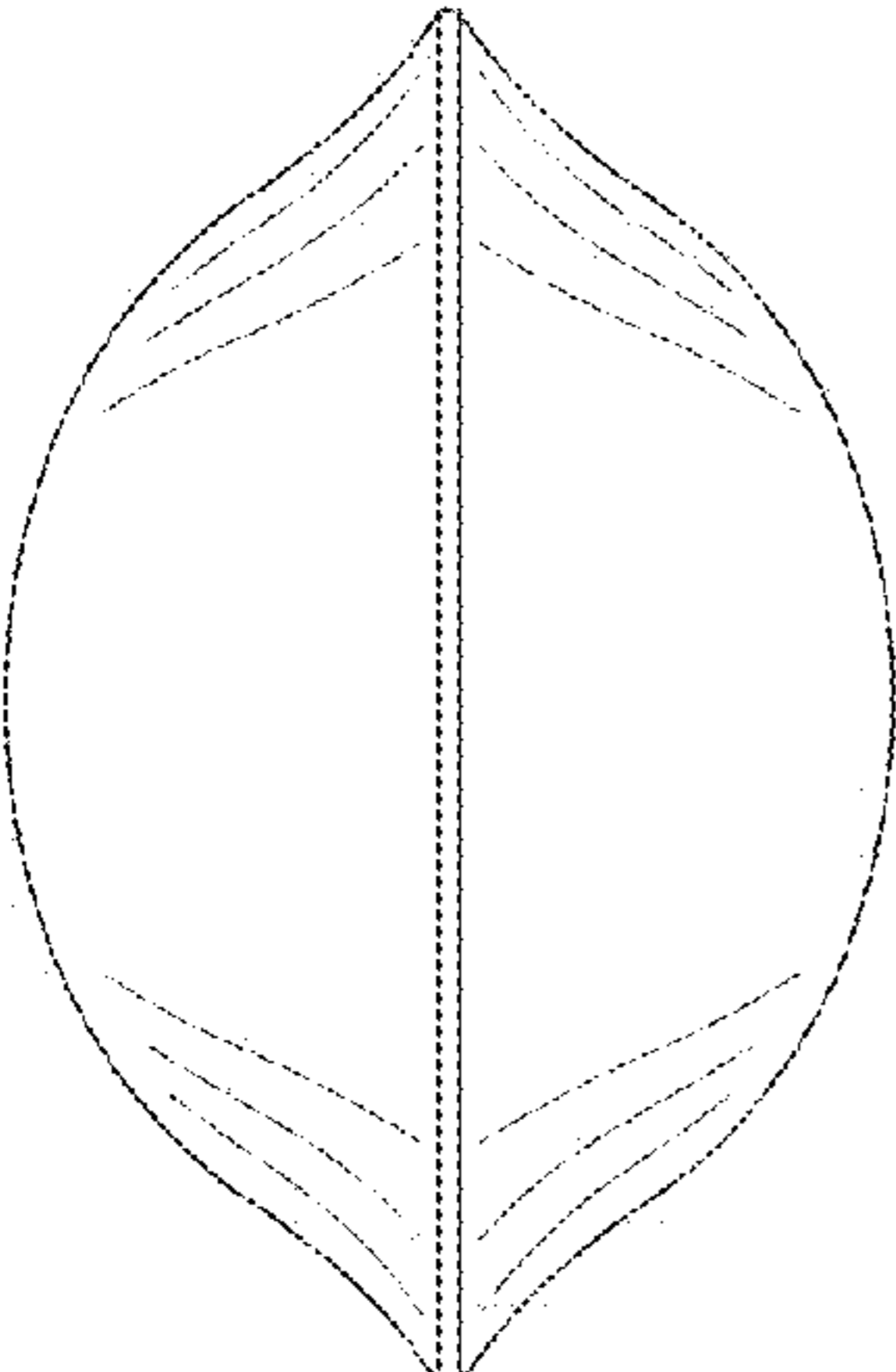

Fig.5

