



US00D974915S

(12) **United States Design Patent**
Bauchwitz

(10) **Patent No.:** **US D974,915 S**
(45) **Date of Patent:** **** Jan. 10, 2023**

(54) **BOTTLE**

(71) Applicant: **Henkel AG & Co. KGaA**, Duesseldorf (DE)

(72) Inventor: **Joana-Maria Bauchwitz**, Duesseldorf (DE)

(73) Assignee: **Henkel AG & Co. KGaA**, Duesseldorf (DE)

(**) Term: **15 Years**

(21) Appl. No.: **29/790,826**

(22) Filed: **Jan. 19, 2022**

Related U.S. Application Data

(62) Division of application No. 29/722,487, filed on Jan. 30, 2020, now Pat. No. Des. 953,868.

(30) **Foreign Application Priority Data**

Jul. 30, 2019 (EM) 006652350

(51) **LOC (14) Cl.** **09-01**

(52) **U.S. Cl.**
USPC **D9/529**; D9/521; D9/574

(58) **Field of Classification Search**
USPC D9/529, 530, 542, 543, 560, 563, 574,
D9/521, 522

(Continued)

(56) **References Cited**

U.S. PATENT DOCUMENTS

D311,133 S * 10/1990 Wiseman D9/521
D352,662 S * 11/1994 McIlvain D9/521

(Continued)

FOREIGN PATENT DOCUMENTS

CN 3342919 * 12/2003
CN 3355275 * 3/2004

(Continued)

Primary Examiner — Brett Miller

Assistant Examiner — Rani J Abdallah

(74) *Attorney, Agent, or Firm* — James J. Cummings

(57) **CLAIM**

The ornamental design for bottle, as shown and described.

DESCRIPTION

FIG. 1 is a front perspective view of a bottle embodying the new design;

FIG. 2 is a front side elevation view thereof;

FIG. 3 is a rear side elevation view thereof;

FIG. 4 is a right side elevation view thereof;

FIG. 5 is a left side elevation view thereof;

FIG. 6 is a top plan view thereof; and,

FIG. 7 is a bottom plan view thereof;

FIG. 8 is a front perspective view of a bottle embodying our new design;

FIG. 9 is a front side elevation view thereof;

FIG. 10 is a rear side elevation view thereof;

FIG. 11 is a right side elevation view thereof;

FIG. 12 is a left side elevation view thereof;

FIG. 13 is a top plan view thereof; and,

FIG. 14 is a bottom plan view thereof;

FIG. 15 is a front perspective view of a bottle embodying our new design;

FIG. 16 is a front side elevation view thereof;

FIG. 17 is a rear side elevation view thereof;

FIG. 18 is a right side elevation view thereof;

FIG. 19 is a left side elevation view thereof;

FIG. 20 is a top plan view thereof; and,

FIG. 21 is a bottom plan view thereof;

FIG. 22 is a front perspective view of a bottle embodying our new design;

FIG. 23 is a front side elevation view thereof;

FIG. 24 is a rear side elevation view thereof;

FIG. 25 is a right side elevation view thereof;

FIG. 26 is a left side elevation view thereof;

FIG. 27 is a top plan view thereof; and,

FIG. 28 is a bottom plan view thereof.

(Continued)

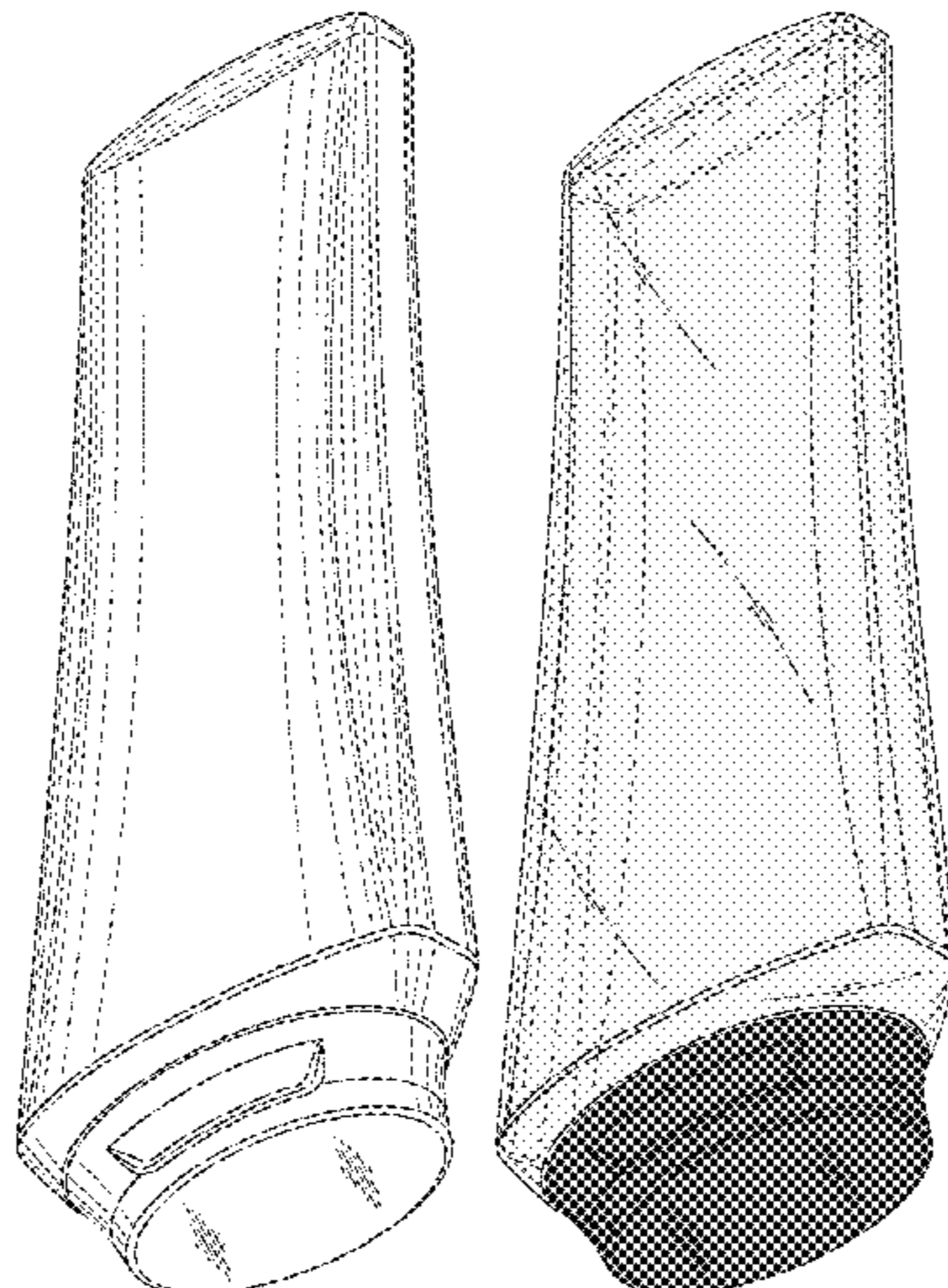

The broken lines shown illustrate portions of the bottle that form no part of the claimed design.

1 Claim, 28 Drawing Sheets

(58) Field of Classification Search

CPC B65D 1/0223; B65D 2501/0081; B65D 79/005; A61J 1/00

See application file for complete search history.

(56) References Cited

U.S. PATENT DOCUMENTS

D375,899	S	*	11/1996	Gerhart	D9/521
D392,898	S	*	3/1998	Butler	D9/574
D419,454	S	*	1/2000	Kokenge	D9/574
D430,034	S	*	8/2000	Kikuchi	D9/529
D444,390	S	*	7/2001	Kokenge	D9/530
D450,593	S	*	11/2001	Jebb	D9/529
D456,717	S	*	5/2002	Roher	D9/574
D458,149	S	*	6/2002	Cummings	D9/574
D459,996	S	*	7/2002	Kuzma	D9/574
D460,694	S	*	7/2002	Llusca	D9/529
D467,807	S	*	12/2002	Bakic	D9/574
D479,470	S	*	9/2003	Braaten	D9/573
D486,395	S	*	2/2004	Lovell	D9/521
D486,400	S	*	2/2004	Bakic	D9/530
D495,957	S	*	9/2004	Bakic	D9/529
D508,406	S	*	8/2005	Kerr	D9/521
D509,441	S	*	9/2005	Wilson	D9/521
D525,135	S	*	7/2006	Bakic	D9/521
D526,566	S	*	8/2006	Bakic	D9/521
D527,641	S	*	9/2006	Bakic	D9/529
D528,005	S	*	9/2006	Bakic	D9/529
D529,811	S	*	10/2006	Ratzlaff	D9/529
D529,812	S	*	10/2006	Ratzlaff	D9/529
D561,045	S	*	2/2008	Lee	D9/574

D580,767	S	*	11/2008	Okin	D9/521
D598,769	S	*	8/2009	Toh	D9/521
D601,425	S	*	10/2009	Miller	D9/522
D609,097	S	*	2/2010	Almstead, Jr.	D9/521
D609,098	S	*	2/2010	Almstead, Jr.	D9/521
D609,572	S	*	2/2010	Ribadeneira Mejia	D9/521
D628,488	S	*	12/2010	Johnson	D9/521
D632,582	S	*	2/2011	Kuzma	D9/530
D636,267	S	*	4/2011	Shiota	D9/529
D652,302	S	*	1/2012	Drake	D9/521
D721,972	S	*	2/2015	Brewer	D9/529
D723,930	S	*	3/2015	Brewer	D9/529
D737,685	S	*	9/2015	Landrum	D9/574
D737,686	S	*	9/2015	Landrum	D9/574
D738,219	S	*	9/2015	Landrum	D9/574
D745,403	S	*	12/2015	Julier	D9/521
D745,404	S	*	12/2015	Julier	D9/521
D749,955	S	*	2/2016	Staten	D9/529
D753,505	S	*	4/2016	Landrum	D9/574
D776,539	S	*	1/2017	Jin	D9/529
D776,540	S	*	1/2017	Jin	D9/522
D776,541	S	*	1/2017	Jin	D9/522
D784,815	S	*	4/2017	Schigel	D9/521
D790,977	S	*	7/2017	Landrum	D9/521
D804,314	S	*	12/2017	Jeong	D9/529
D805,392	S	*	12/2017	Wilkins	D9/543
D902,041	S	*	11/2020	Bore	D9/543
D902,042	S	*	11/2020	Bore	D9/543
2008/0296247	A1	*	12/2008	Ribadeneira Mejia	D9/521
					B65D 47/0804	
					215/316	

FOREIGN PATENT DOCUMENTS

CN	3594857	*	1/2007
CN	300789936	*	6/2008
CN	303124578	*	3/2015
EM	004733848-0001	*	3/2018
KR	300566781.0000	*	7/2010

* cited by examiner

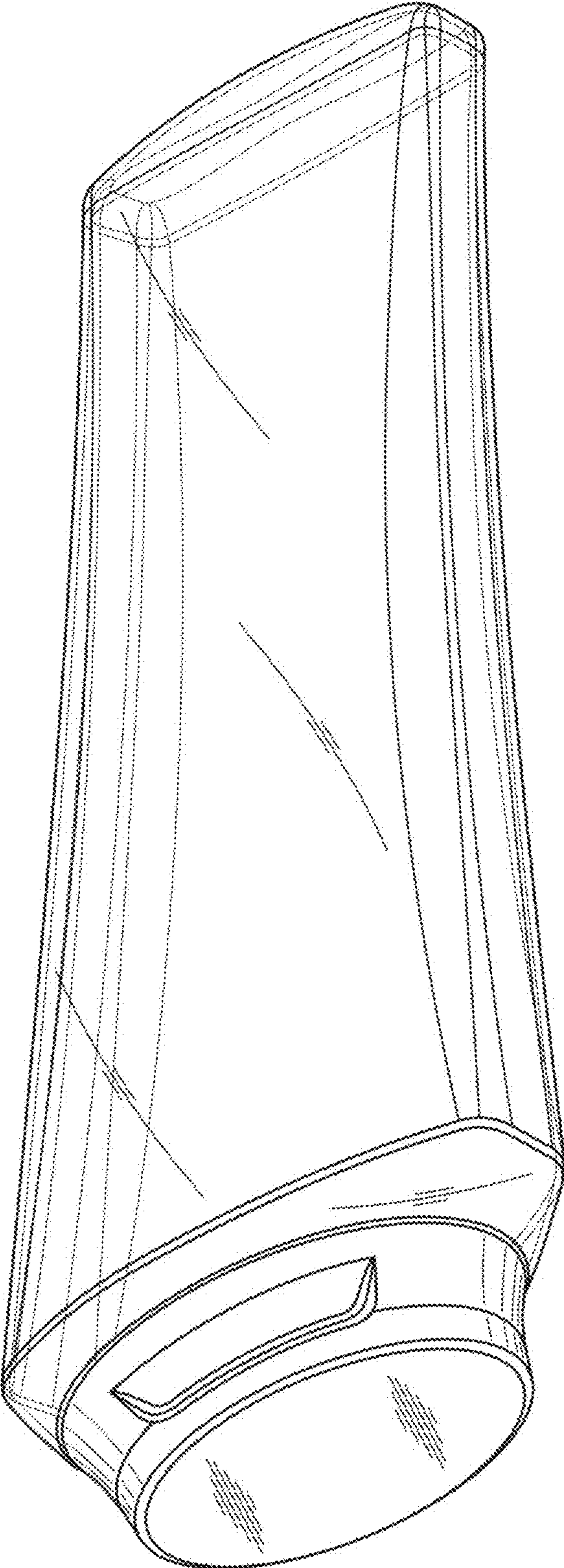

FIG. 01

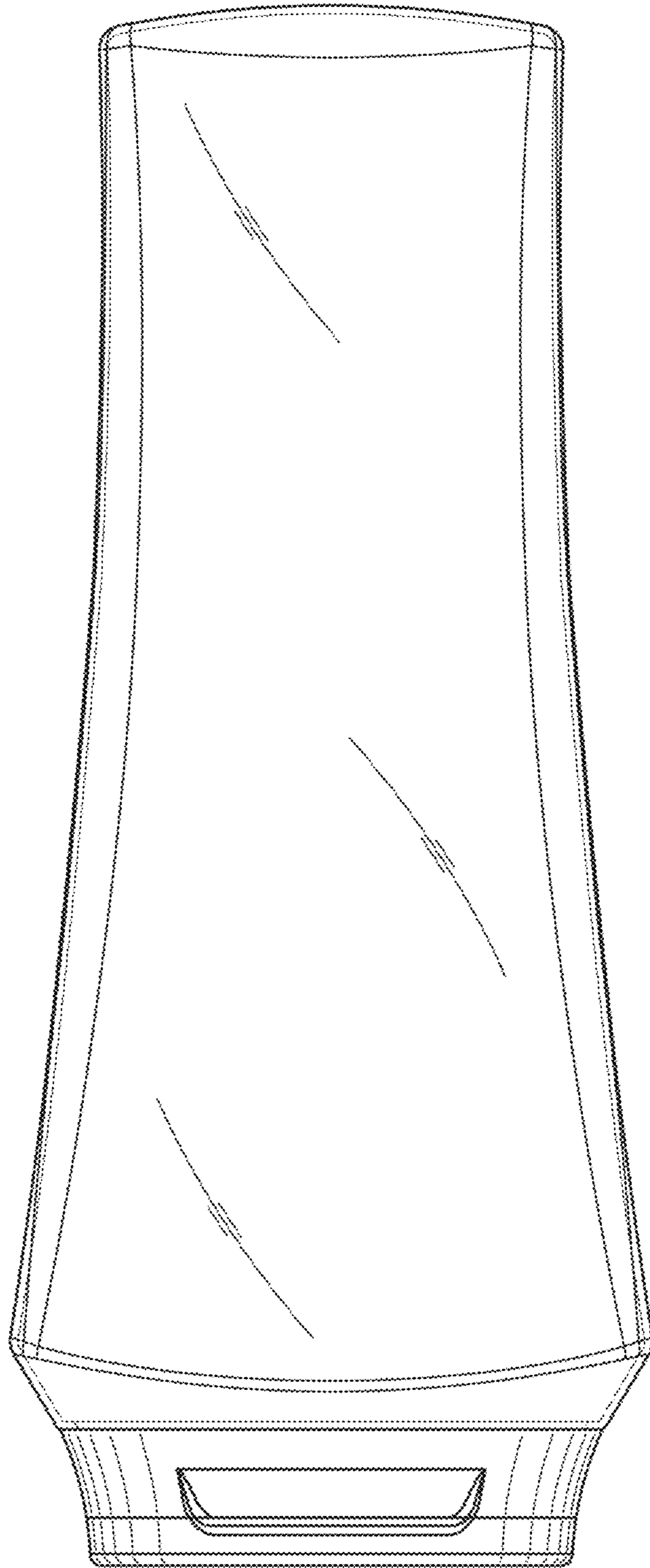

FIG. 02

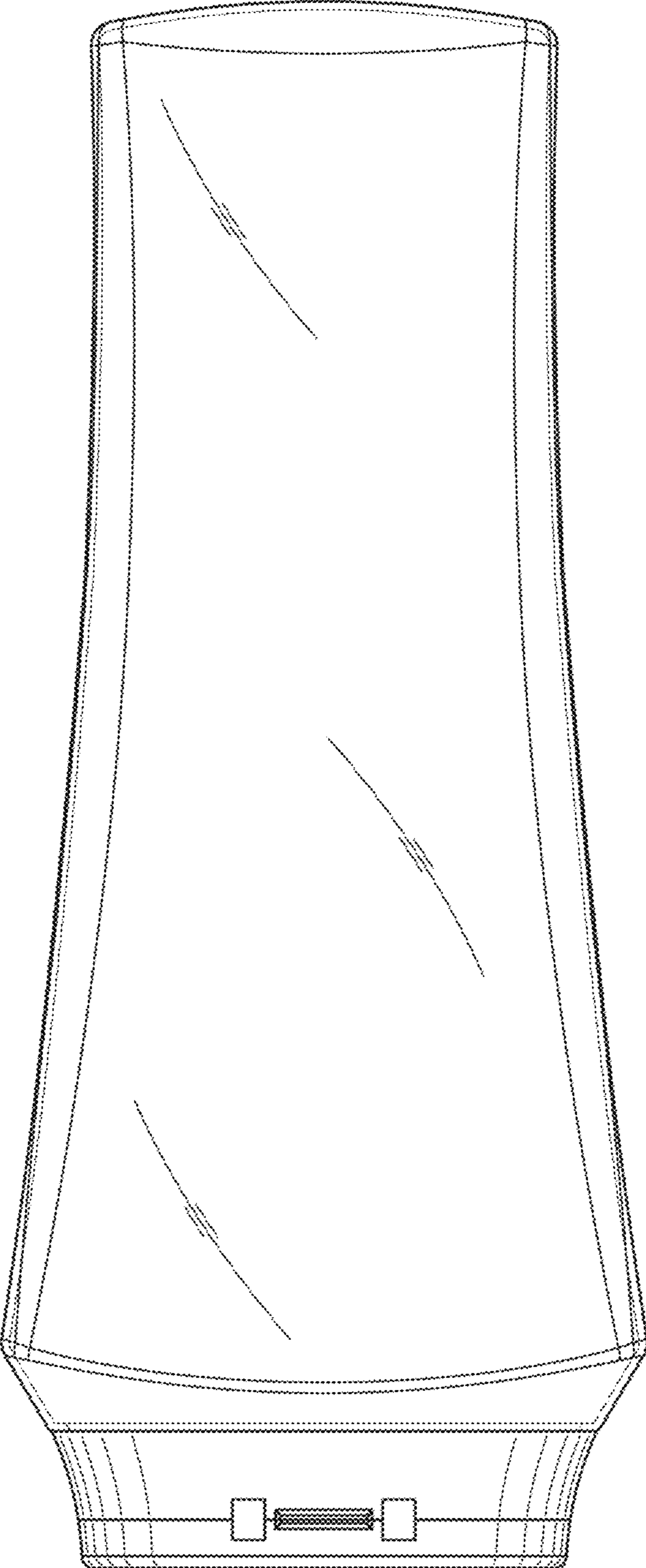

FIG. 03

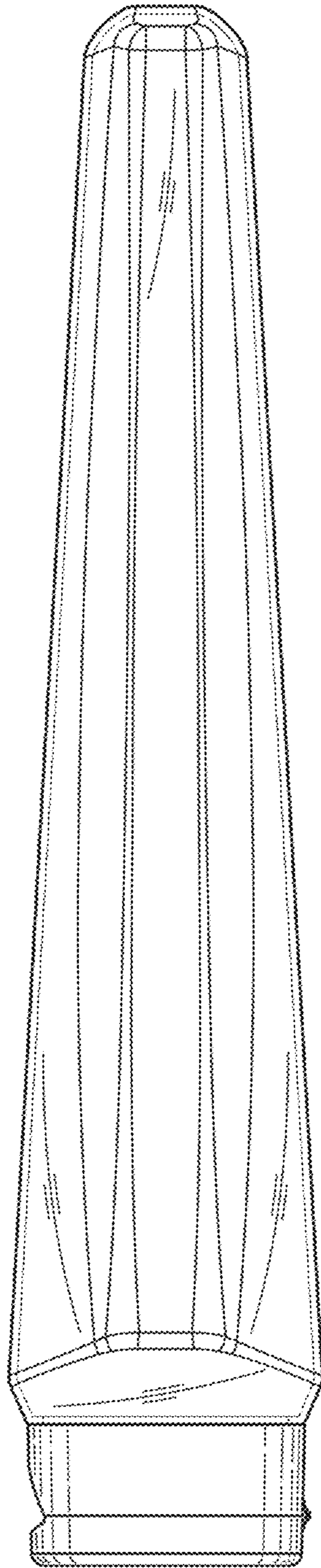

FIG. 04

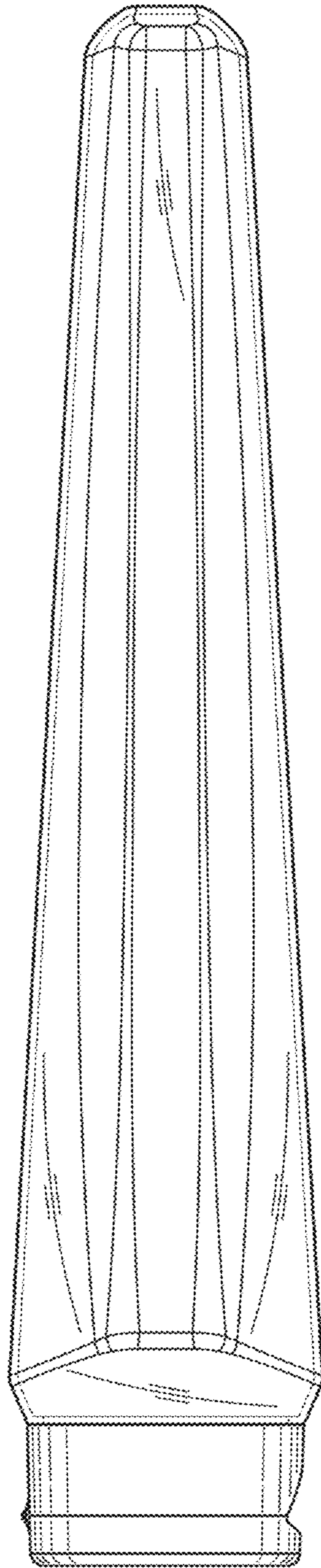

FIG. 05

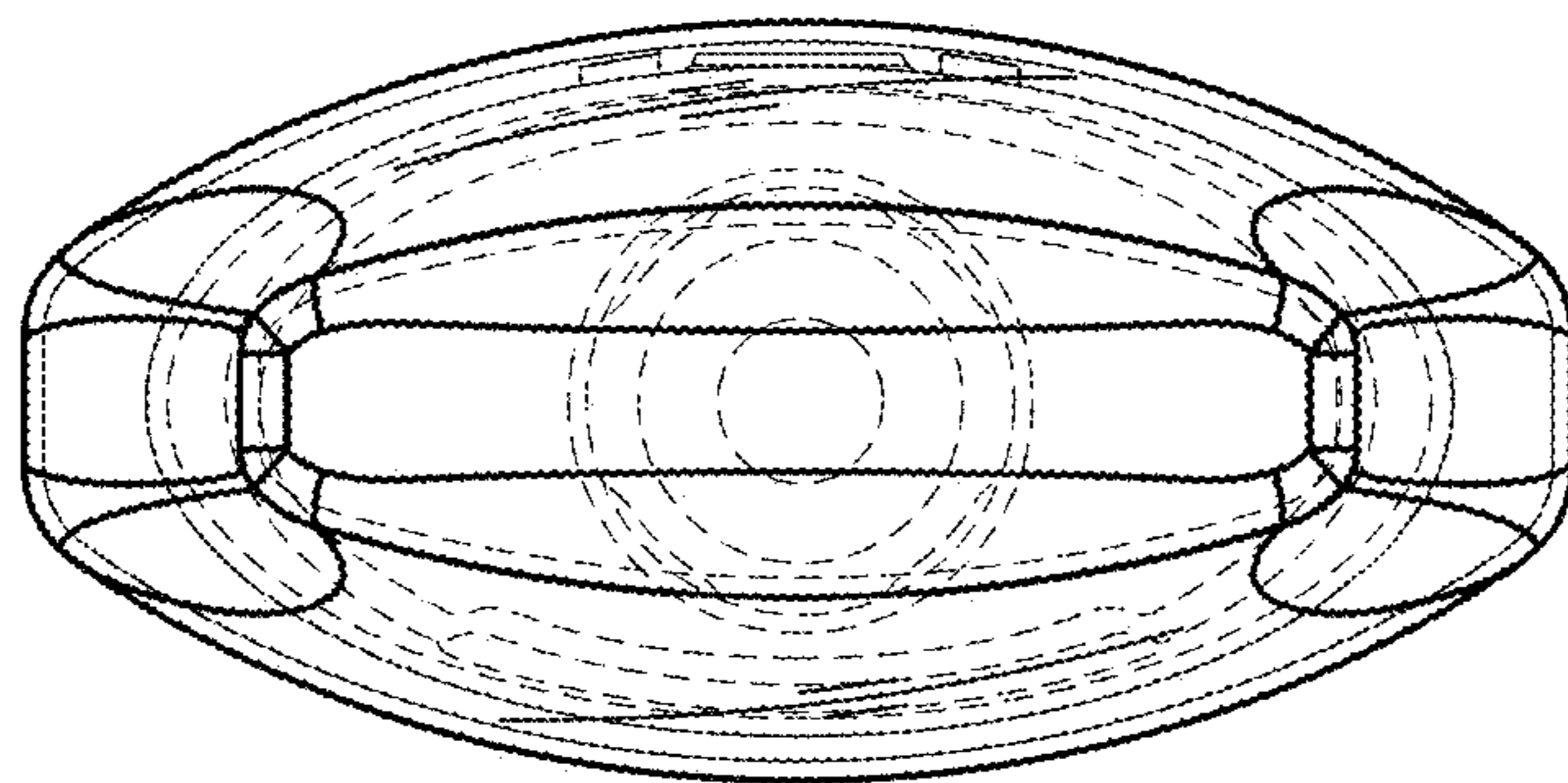

FIG. 06

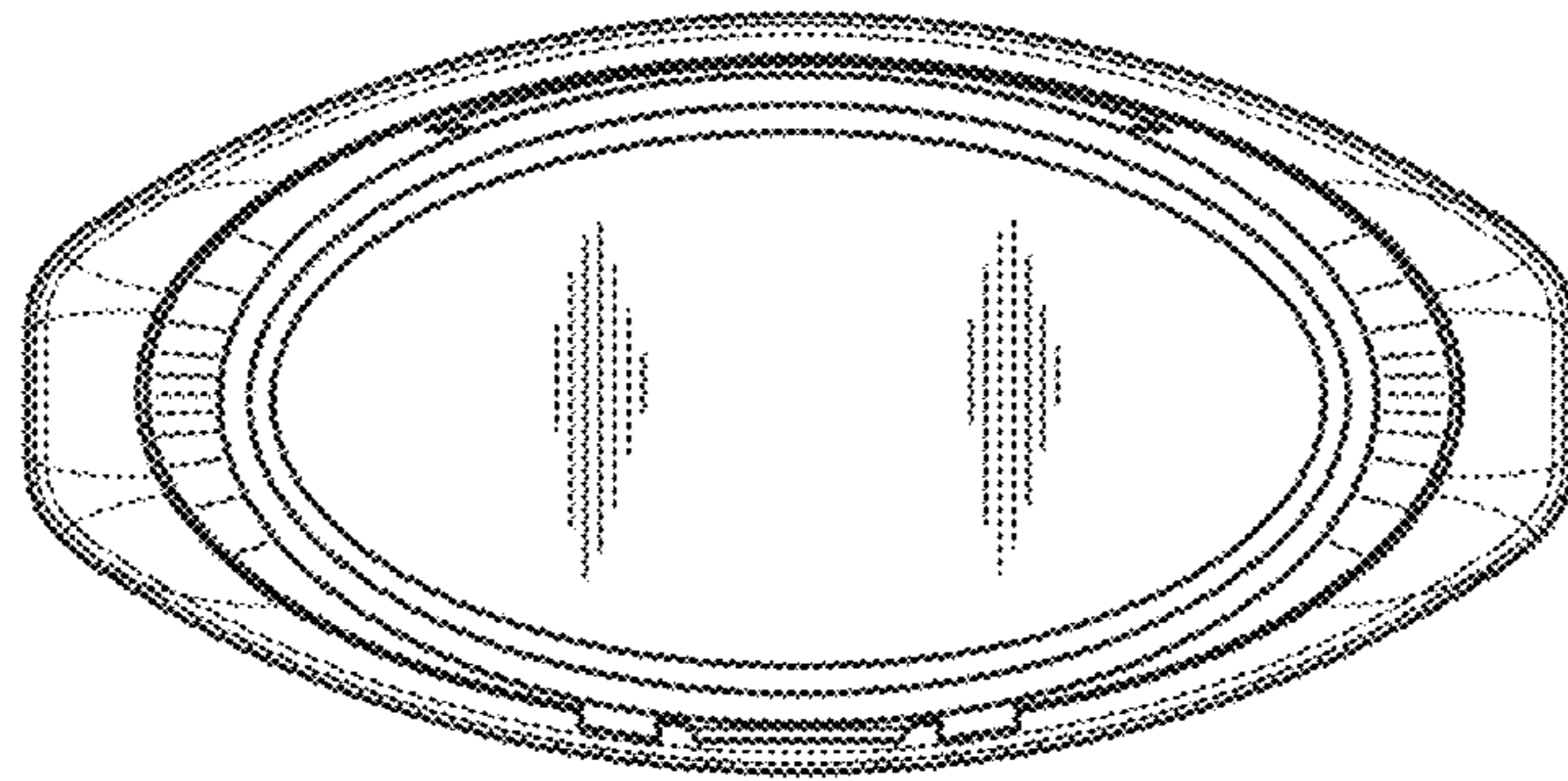

FIG. 07

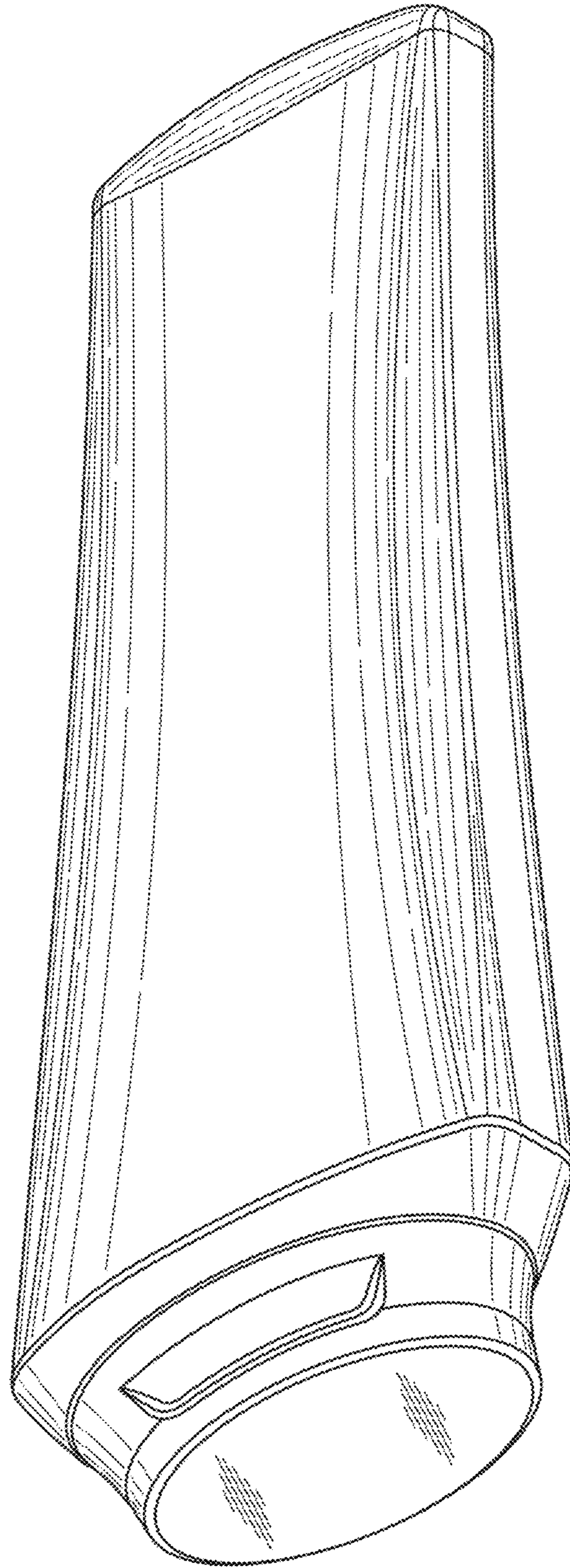

FIG. 08

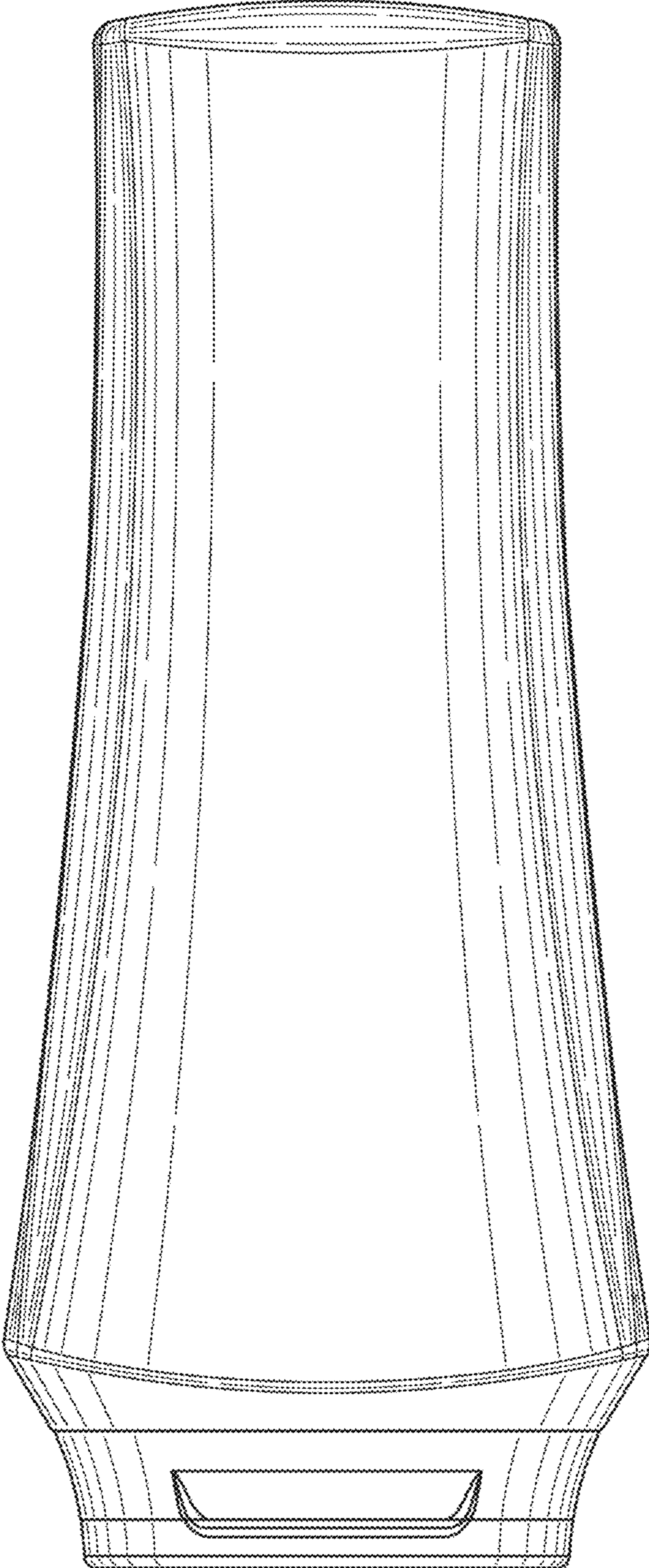

FIG. 09

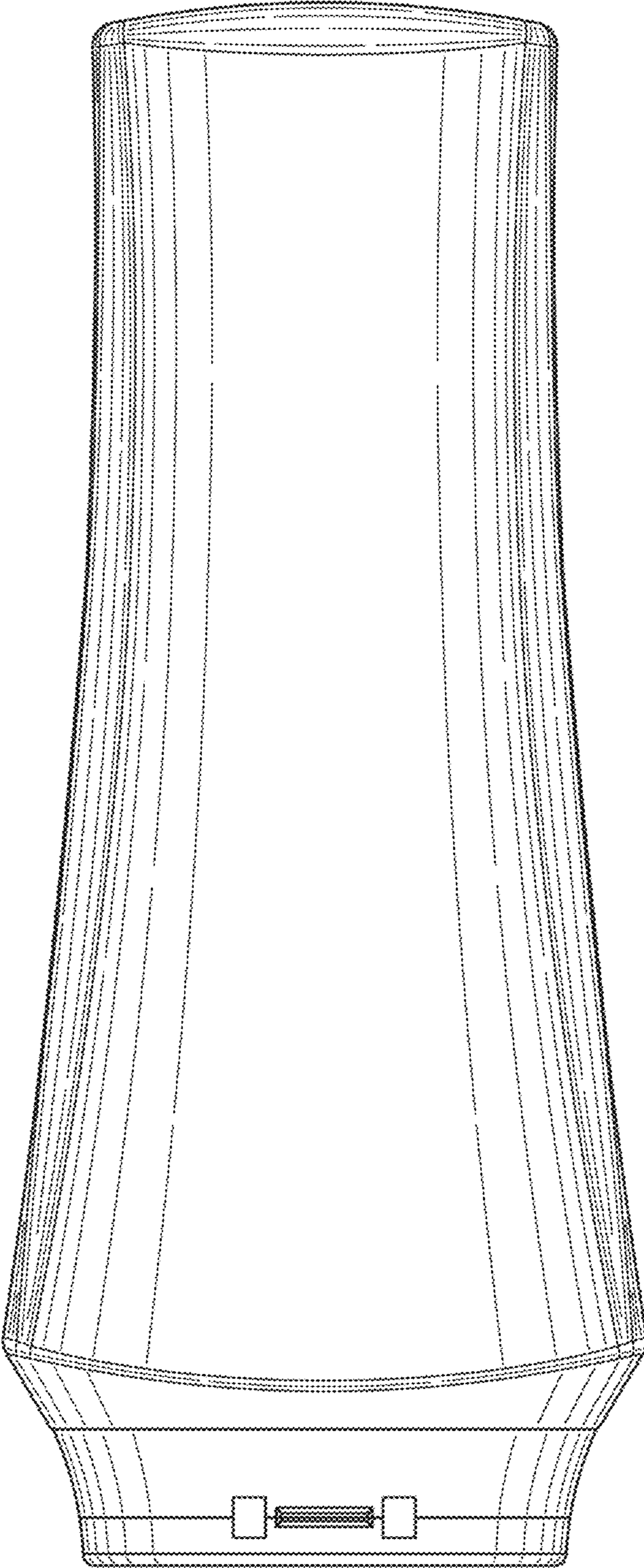

FIG. 10

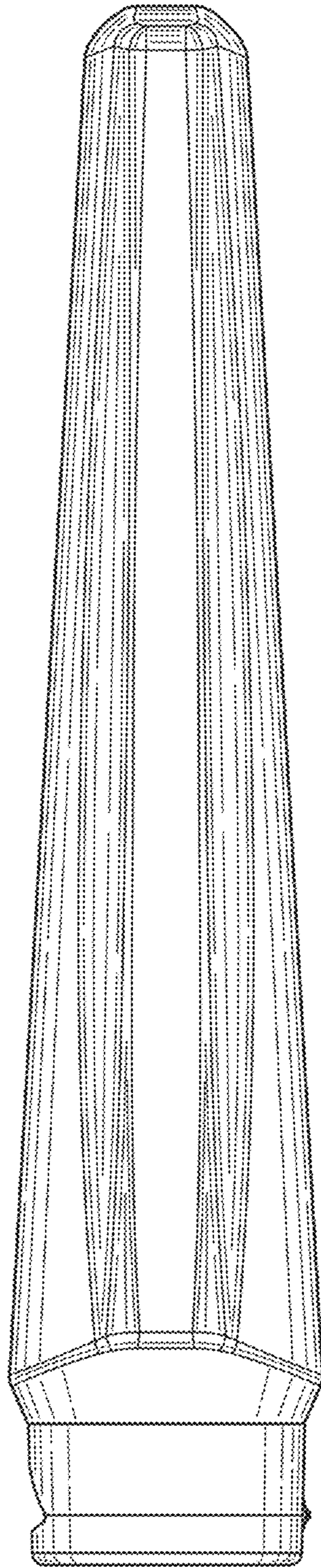

FIG. 11

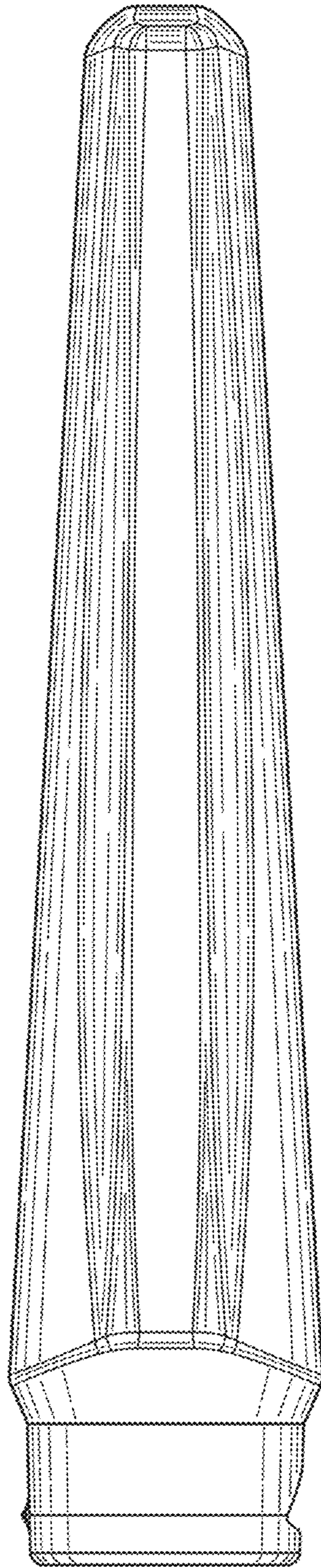

FIG. 12

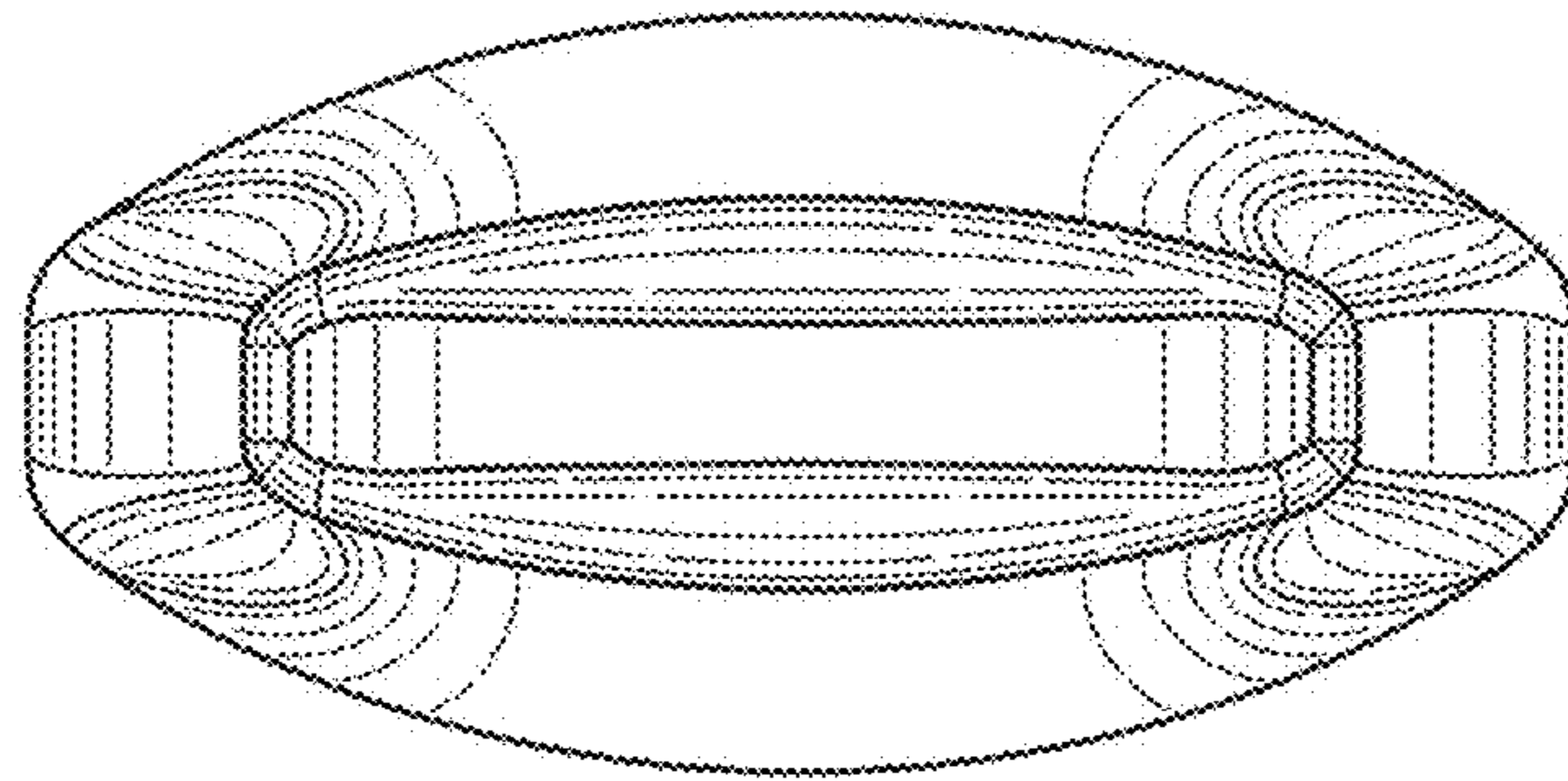

FIG. 13

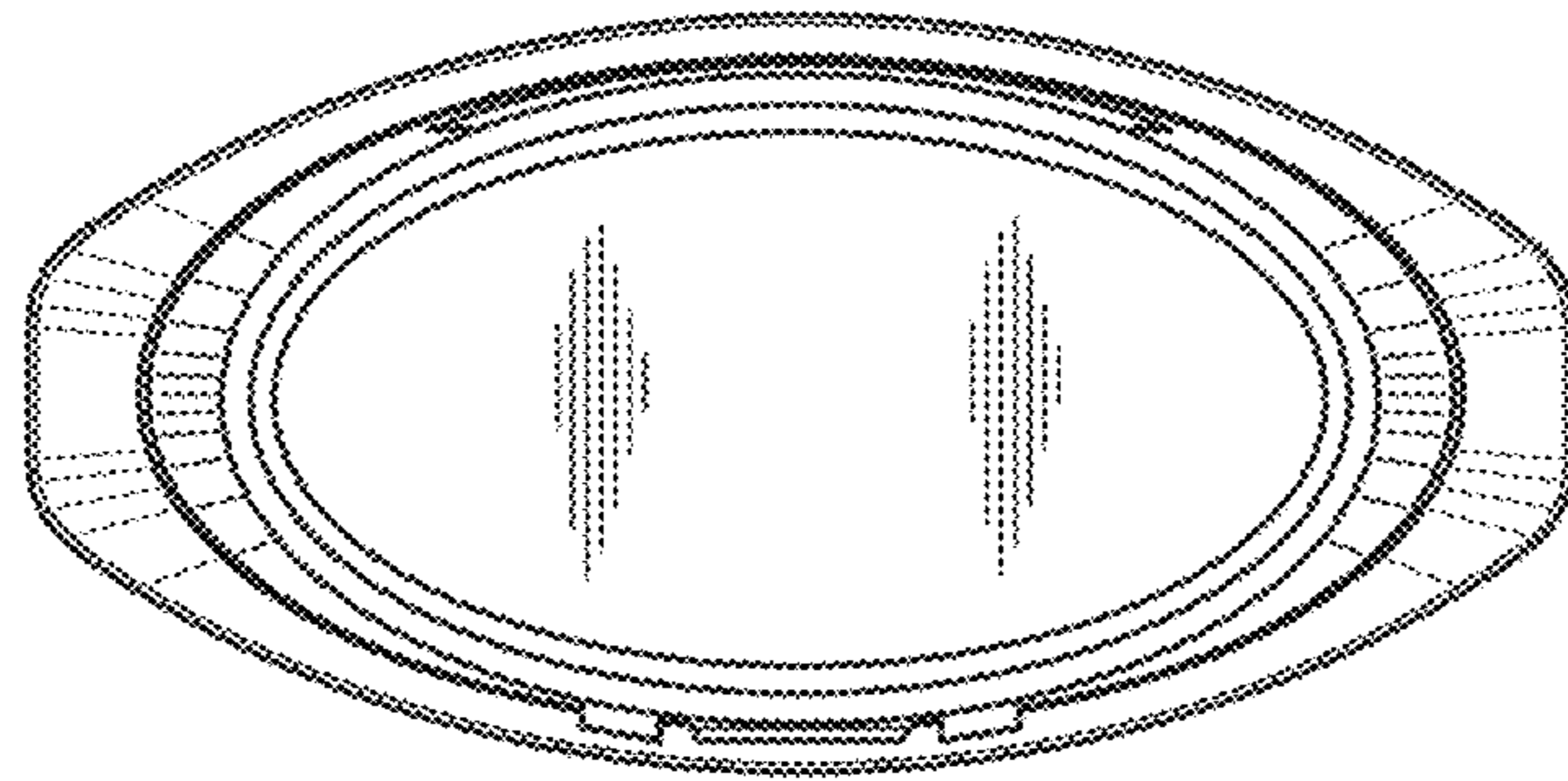

FIG. 14

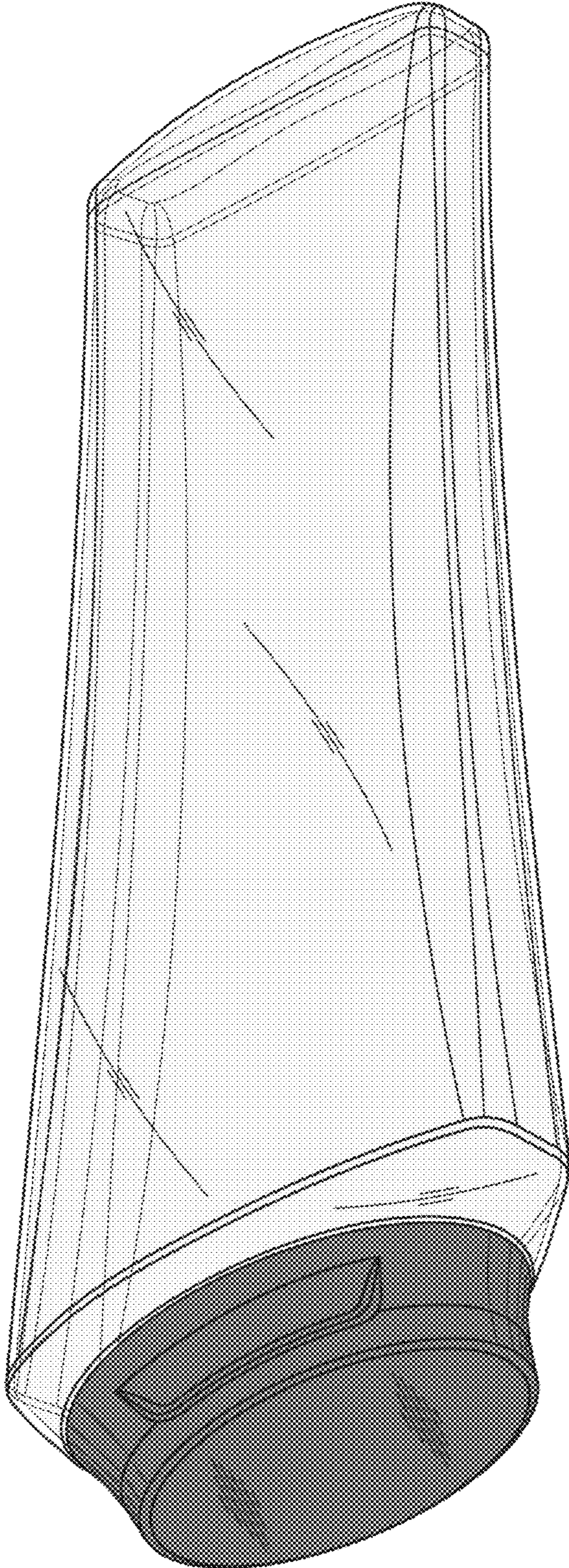

FIG. 15

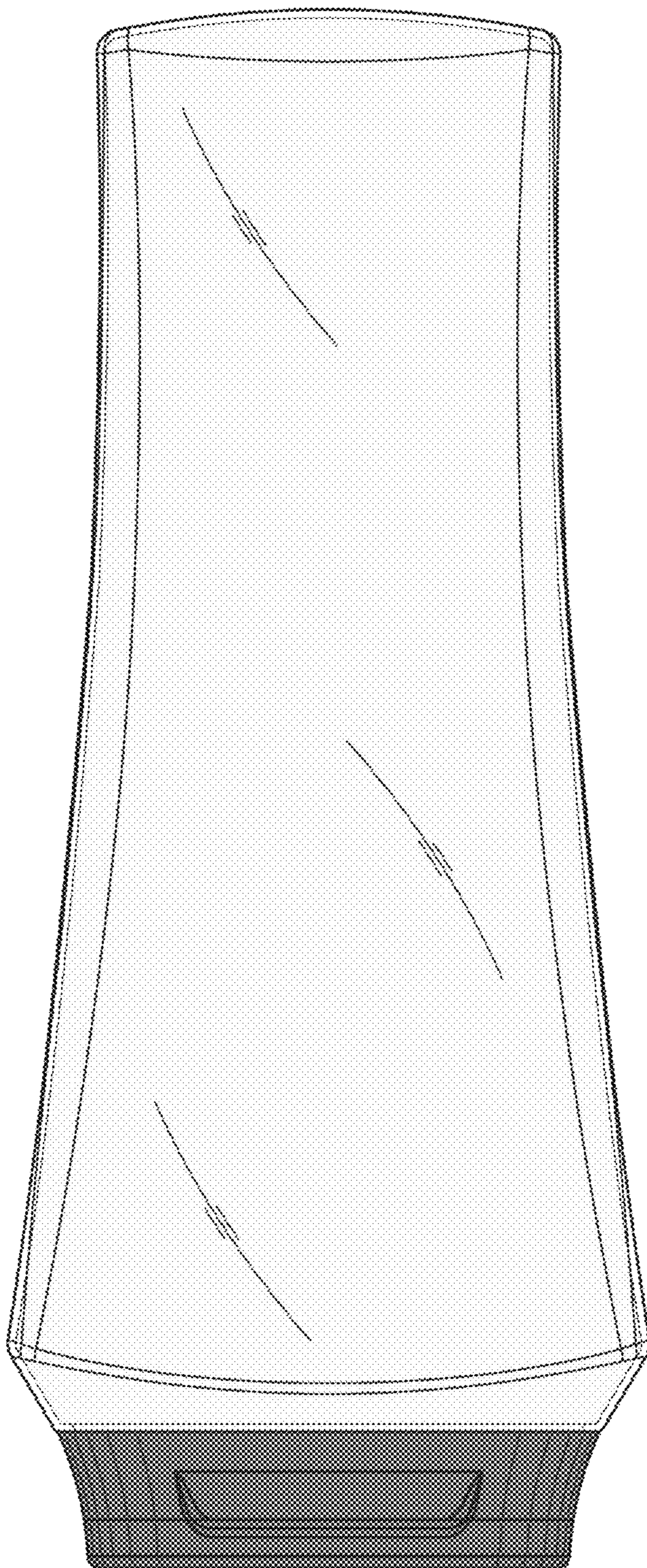

FIG. 16

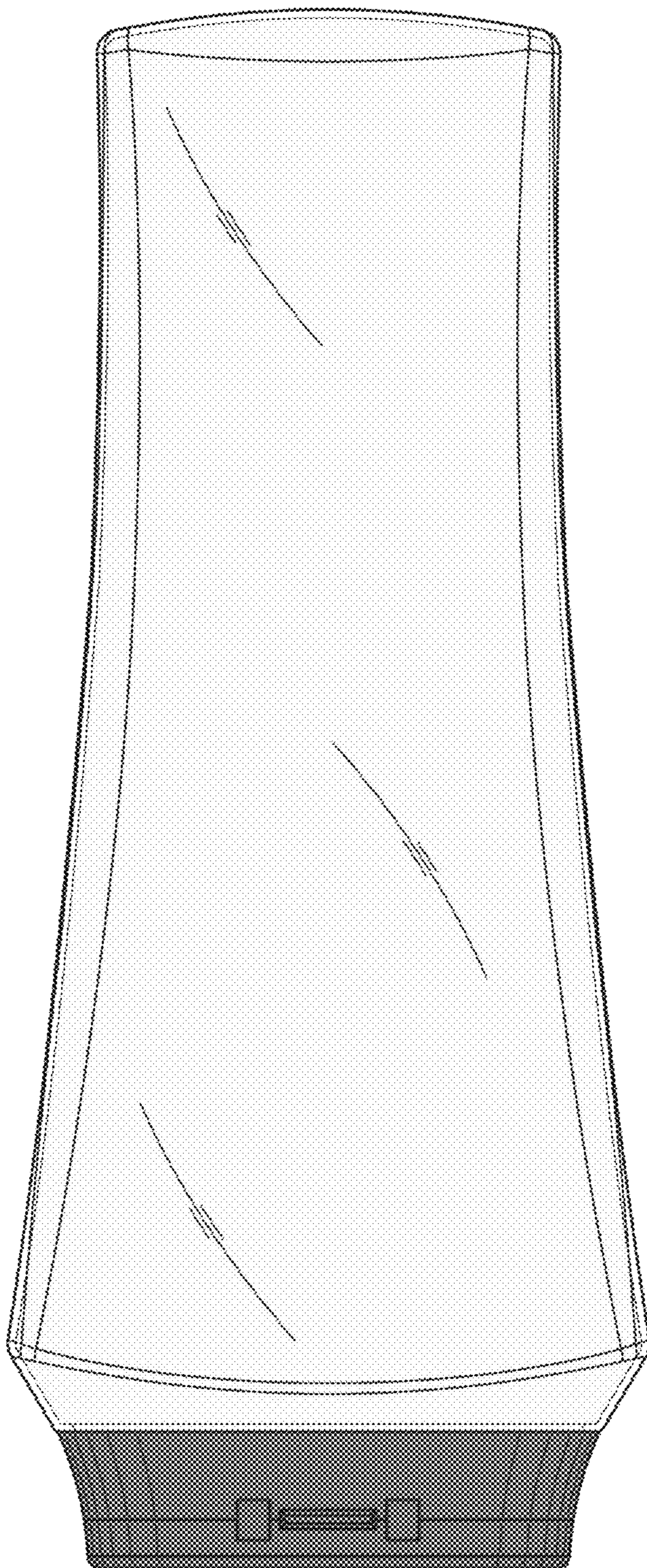

FIG. 17

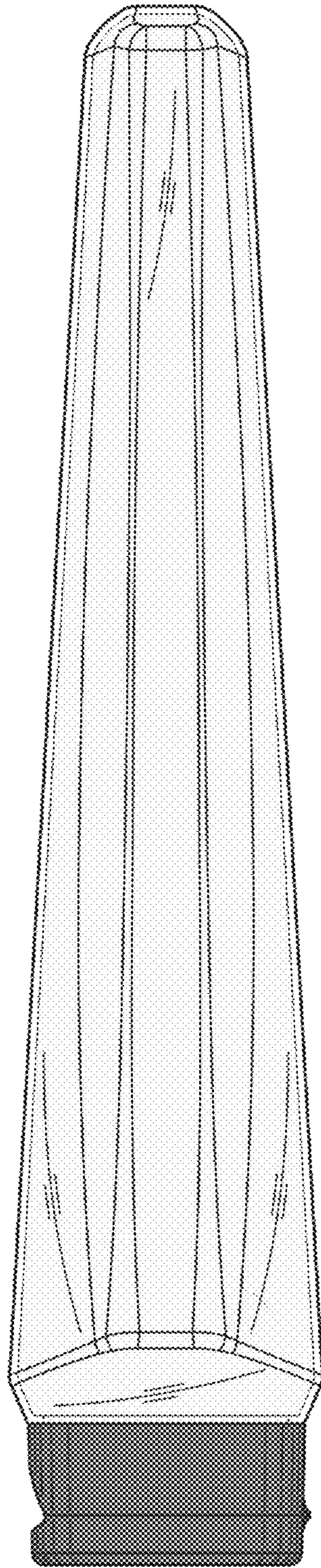

FIG. 18

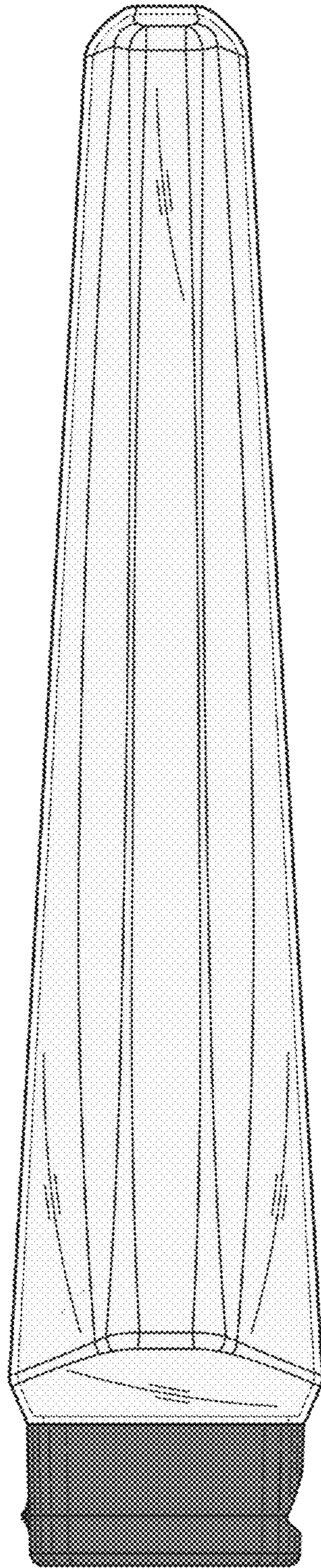

FIG. 19

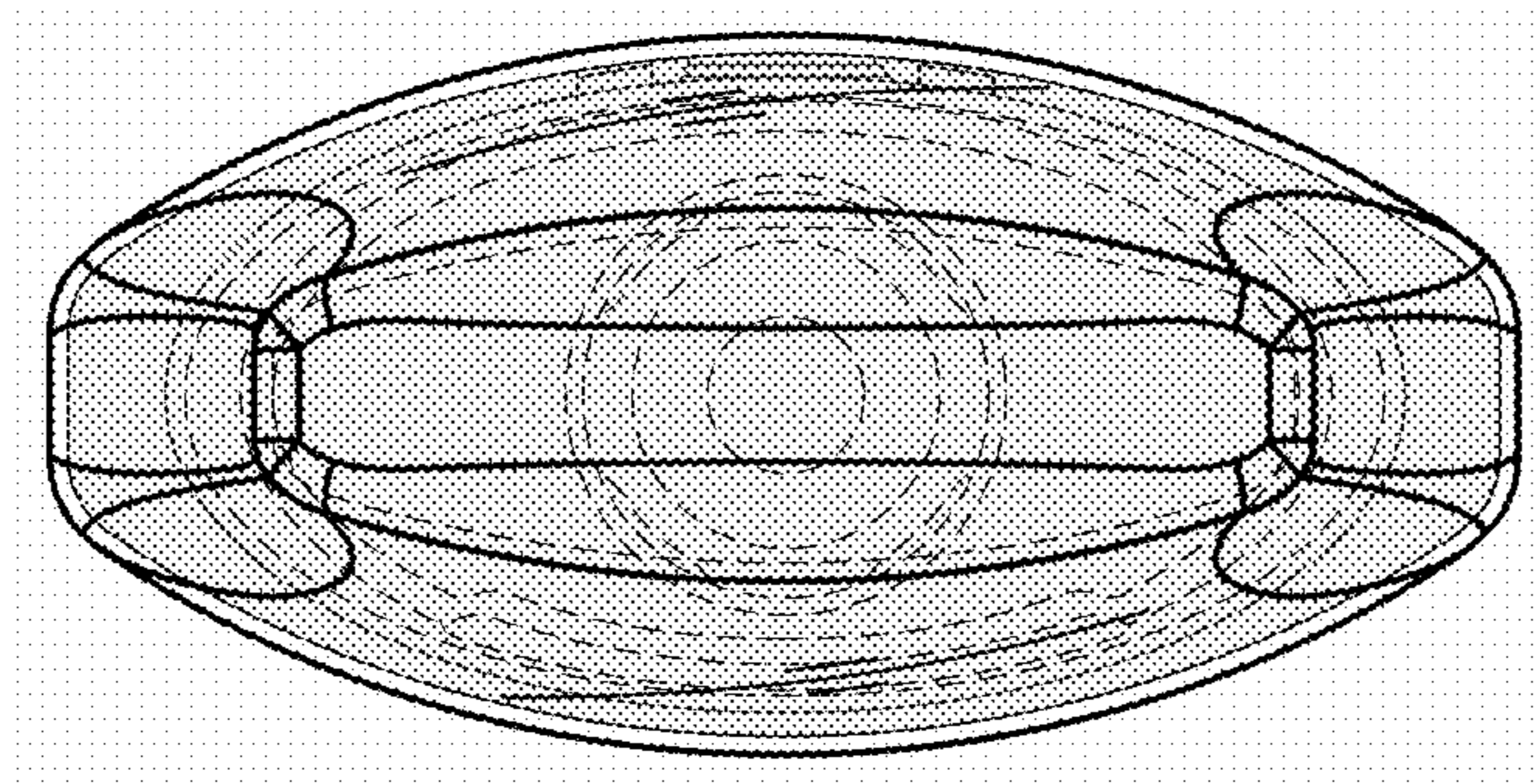

FIG. 20

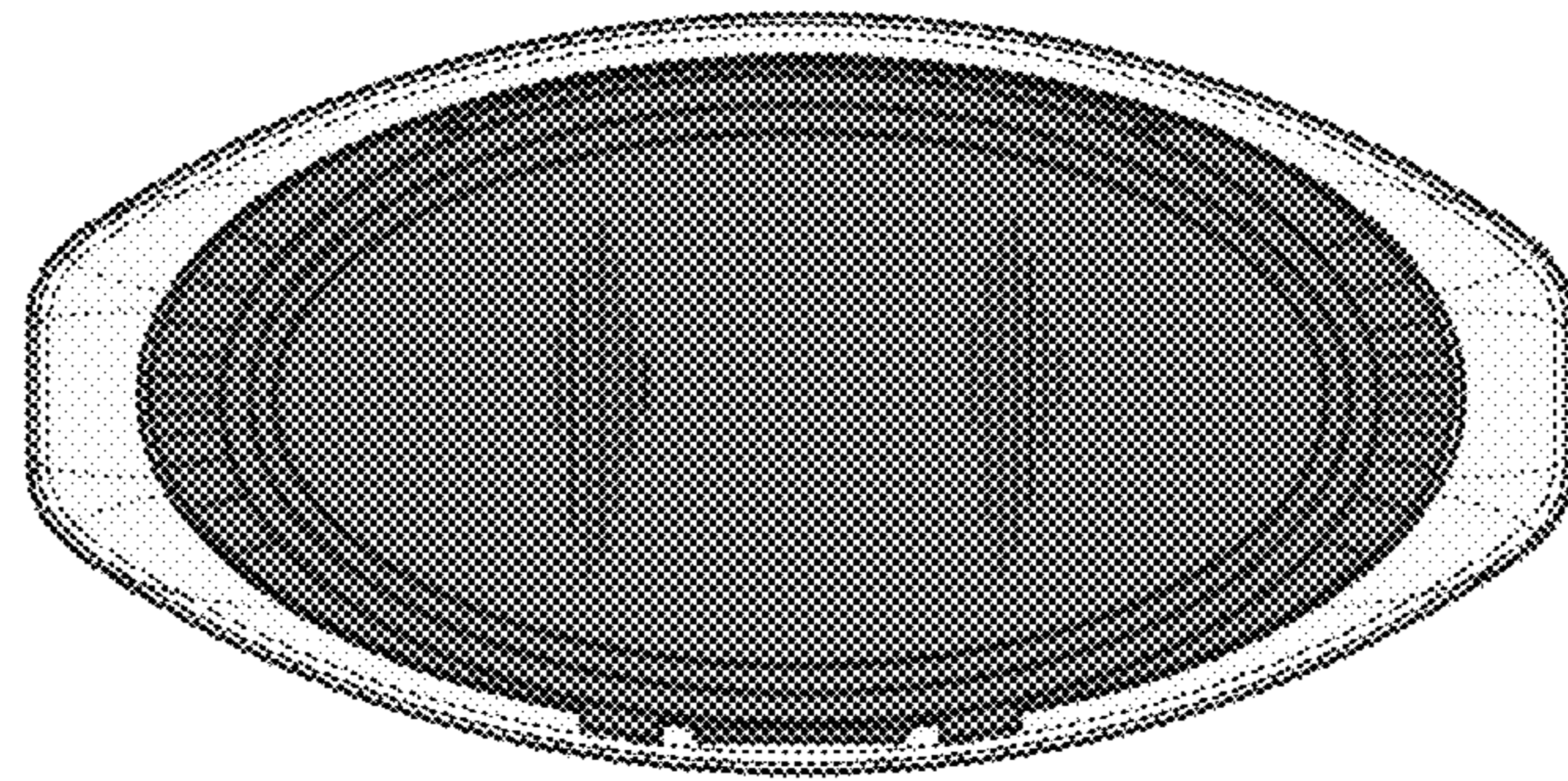

FIG. 21

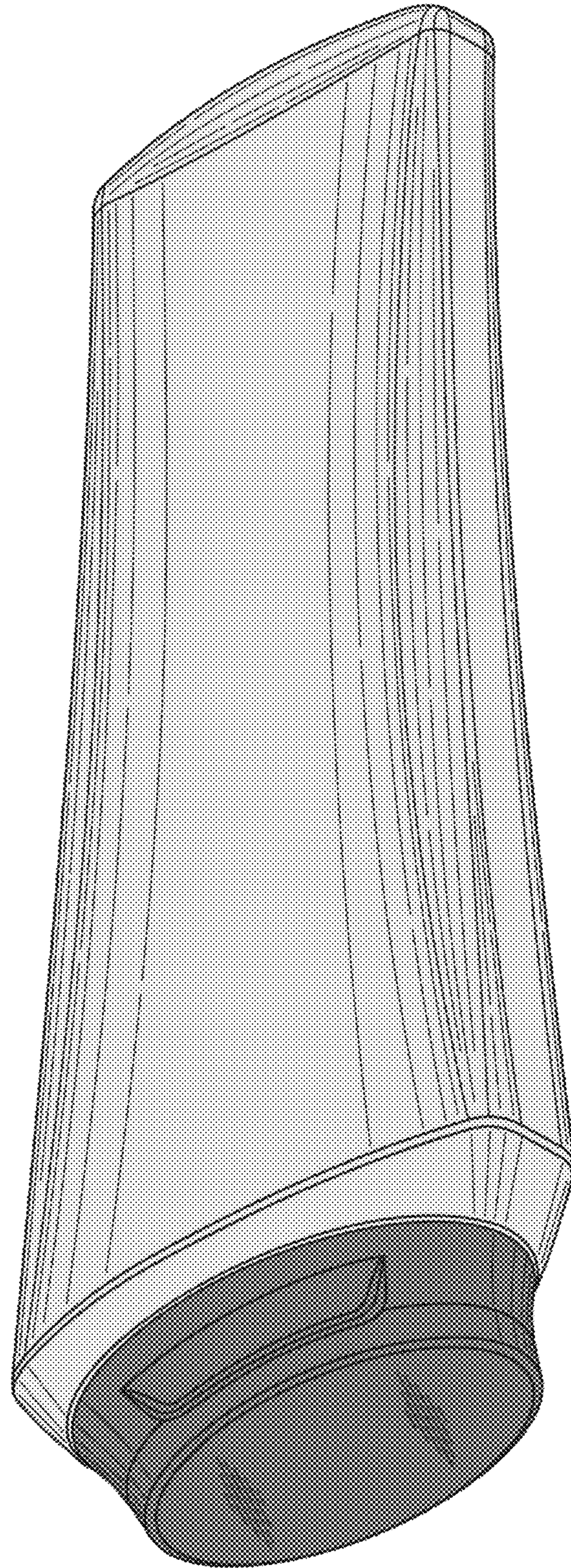

FIG. 22

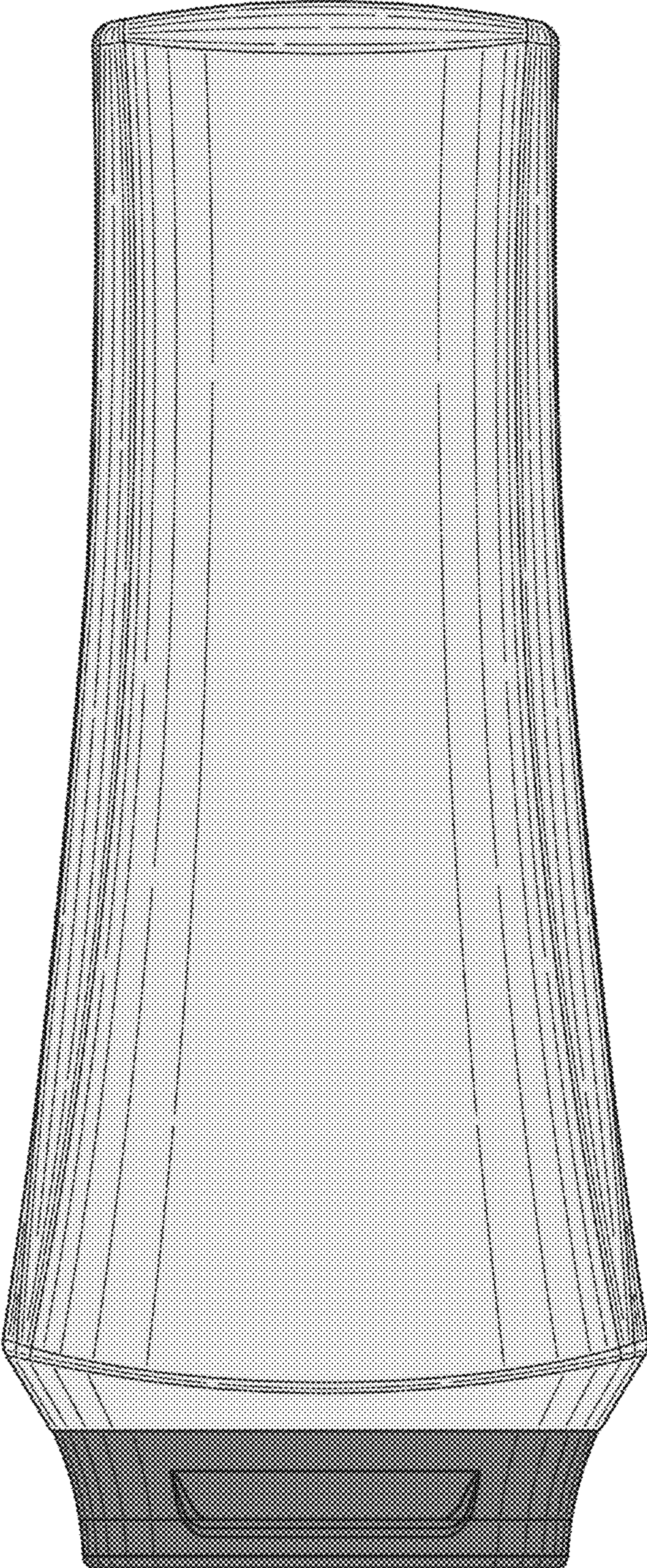

FIG. 23

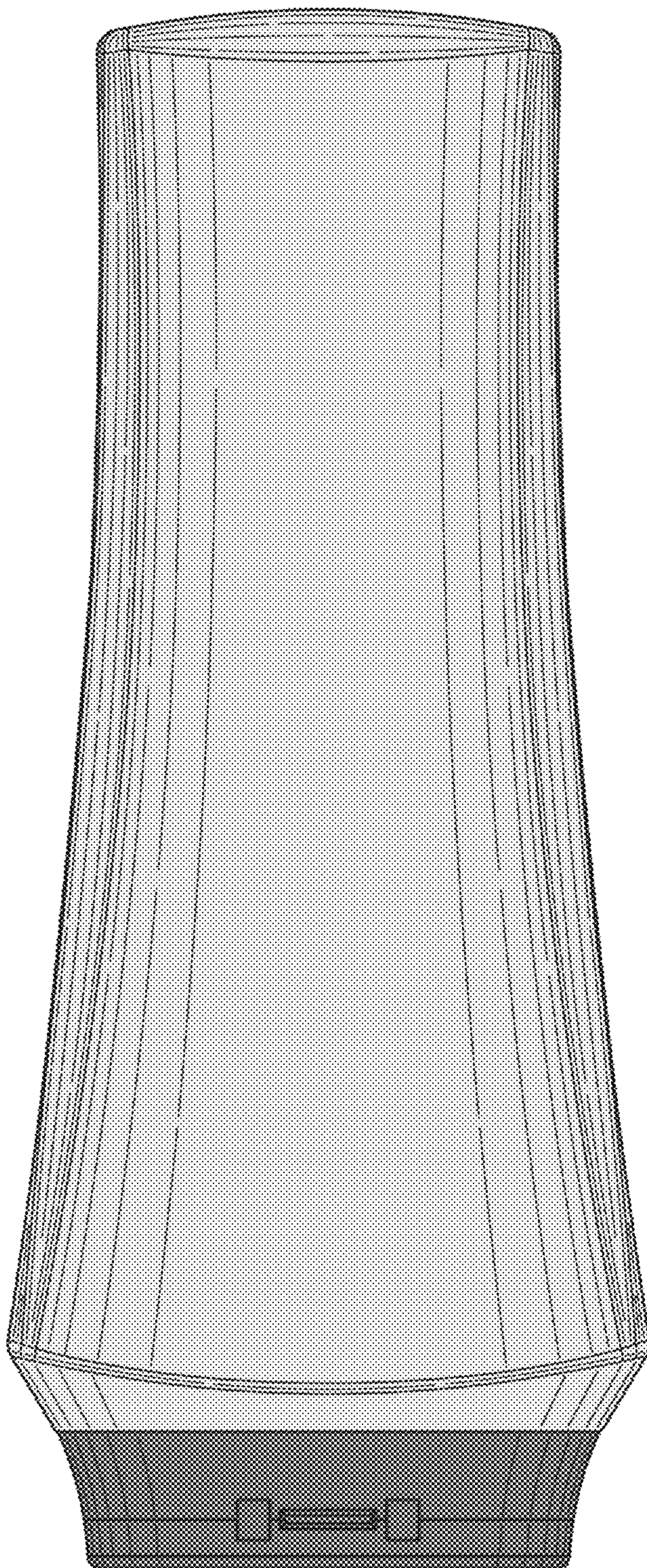

FIG. 24

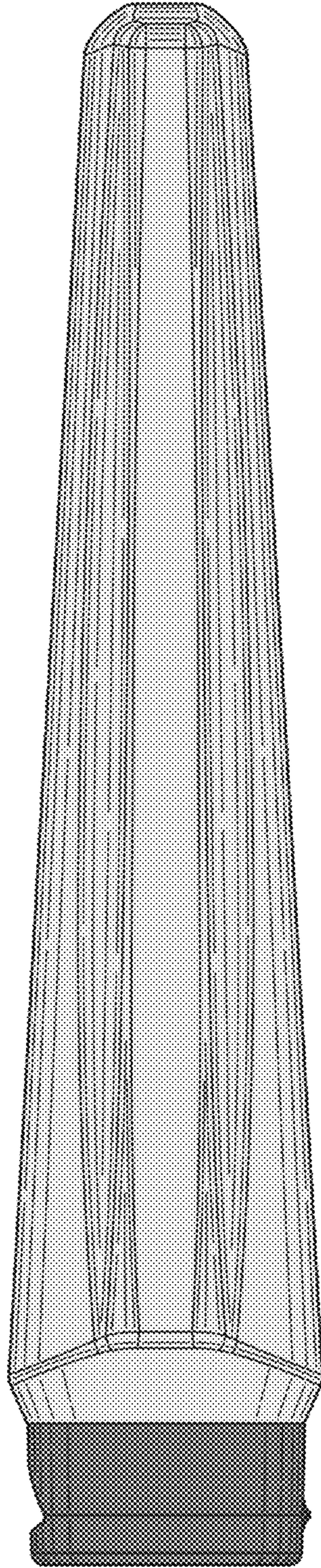

FIG. 25

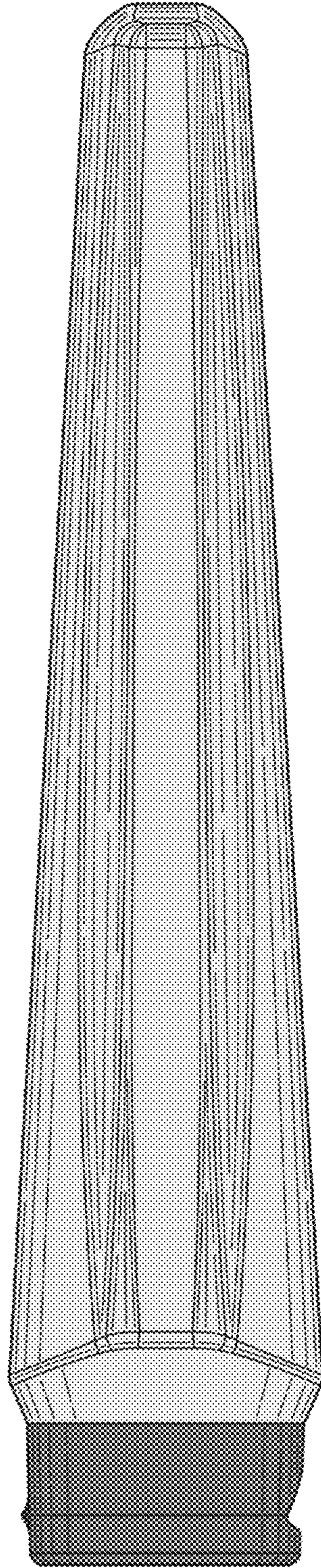

FIG. 26

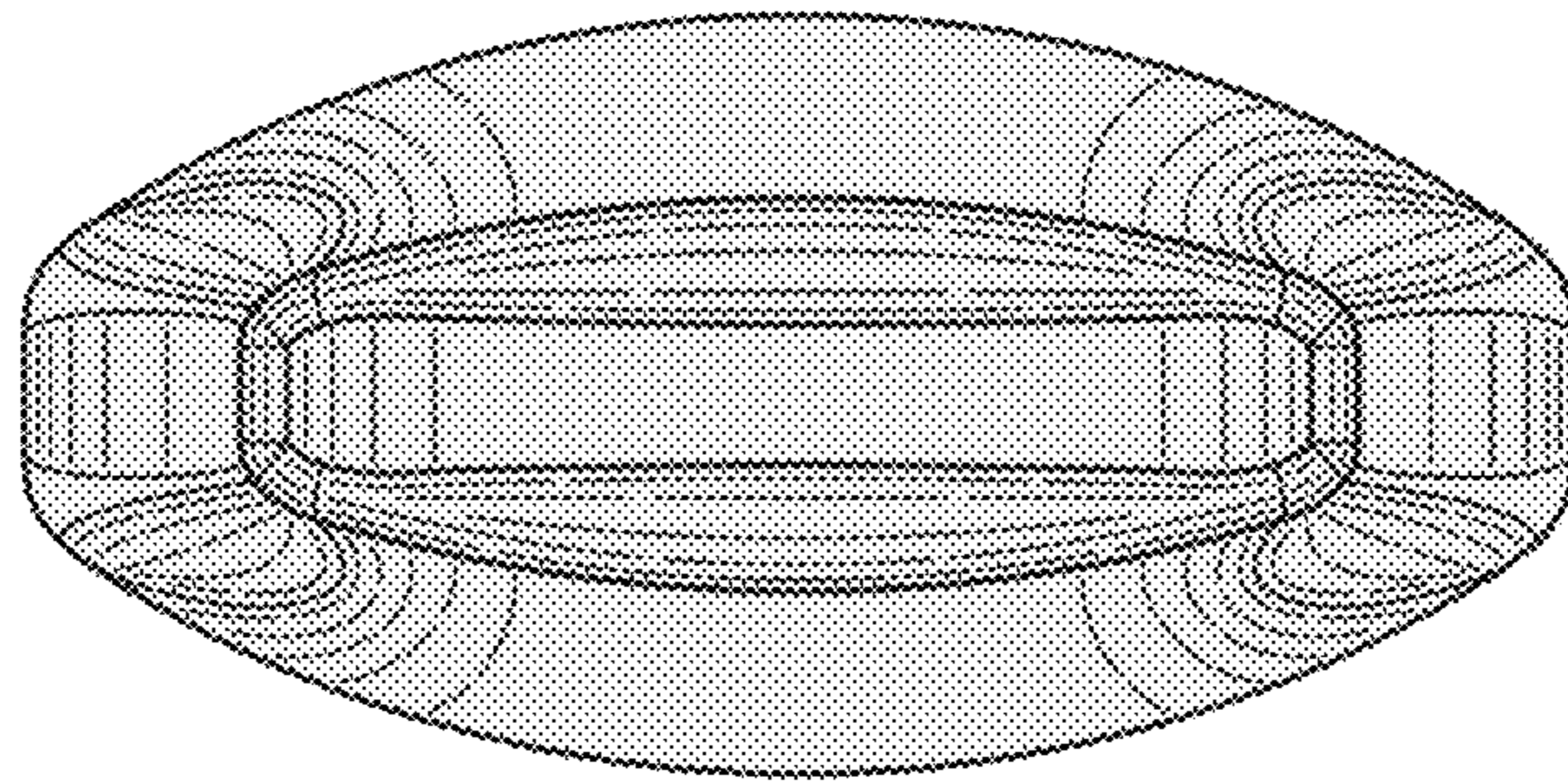

FIG. 27

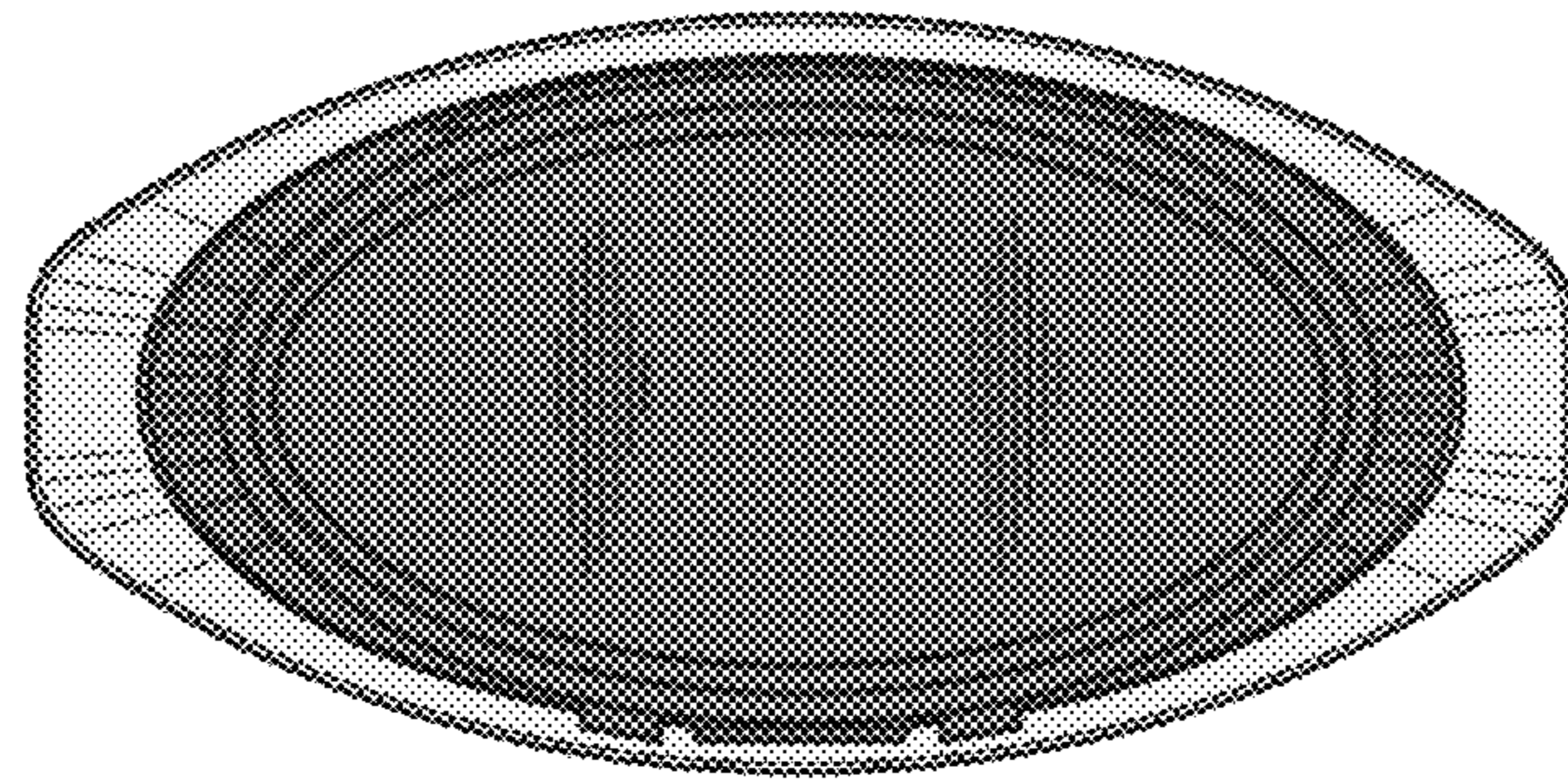

FIG. 28