



US00D974889S

(12) **United States Design Patent**
Chen

(10) **Patent No.:** **US D974,889 S**
(45) **Date of Patent:** **** Jan. 10, 2023**

(54) **PICTURE HANGING TOOL**
(71) Applicant: **Jian Chen**, Yuanjiang (CN)
(72) Inventor: **Jian Chen**, Yuanjiang (CN)
(**) Term: **15 Years**

7,392,593 B2 * 7/2008 Rivers G01C 9/12
33/391
8,061,051 B2 * 11/2011 Allemand G01C 9/34
D10/69
8,672,286 B2 * 3/2014 Darre A47G 1/164
33/666

(Continued)

(21) Appl. No.: **29/809,857**
(22) Filed: **Sep. 30, 2021**

FOREIGN PATENT DOCUMENTS

CN 306201535 S 12/2020

(30) **Foreign Application Priority Data**

Aug. 4, 2021 (CN) 202130503180.6

(51) **LOC (14) Cl.** **08-11**
(52) **U.S. Cl.**
USPC **D8/373**

(58) **Field of Classification Search**
USPC D10/69, 65; D13/184, 110;
D23/250-252, 254; D7/388, 701;
D8/14-16, 19-20, 72-74, 300, 303,
D8/306-308, 313, 315, 321, 317,
D8/349-350, 354-356, 358-359, 363,
D8/373-378, 367-370, 382-383,
D8/386-387, 393, 61, 88-89; D9/426,
D9/502, 750
CPC ... G01C 9/28; G01C 9/26; G01C 1/00; G01C
9/36; G01C 9/24
See application file for complete search history.

OTHER PUBLICATIONS

Veamor All-in-One Picture Hanging Kit, Date Visited: Sep. 19, 2022, Amazon, Date Available: Mar. 31, 2021, <https://www.amazon.co.uk/VERMOR-Multifunction-Picture-Hanging-Tool/dp/B091GQ8YNH> (Year: 2021).*

Primary Examiner — Karen S Acker
Assistant Examiner — Elizabeth S Ko
(74) *Attorney, Agent, or Firm* — Jeenam Park

(57) **CLAIM**

The ornamental design for a picture hanging tool, substantially as shown and described.

DESCRIPTION

FIG. 1 is a top, front and left side perspective view of a picture hanging tool, showing my new design;
FIG. 2 is a bottom, front and left side perspective view thereof;
FIG. 3 is a top plan view thereof;
FIG. 4 is a bottom plan view thereof;
FIG. 5 is a left side elevational view thereof;
FIG. 6 is a right side elevational view thereof;
FIG. 7 is a rear elevational view thereof; and,
FIG. 8 is a front elevational view thereof.
The broken lines in the drawings illustrate the portions of the picture hanging tool, which form no part of the claimed design.

(56) **References Cited**

U.S. PATENT DOCUMENTS

4,745,689 A * 5/1988 Hiltz G01C 9/26
33/DIG. 1
5,353,509 A * 10/1994 Black G01C 9/28
33/476
5,531,031 A * 7/1996 Green G01C 15/008
33/286
D386,067 S 11/1997 Hamerski et al.
D395,594 S 6/1998 Bries et al.
7,171,755 B1 * 2/2007 Arent A47G 1/16
33/194

1 Claim, 8 Drawing Sheets

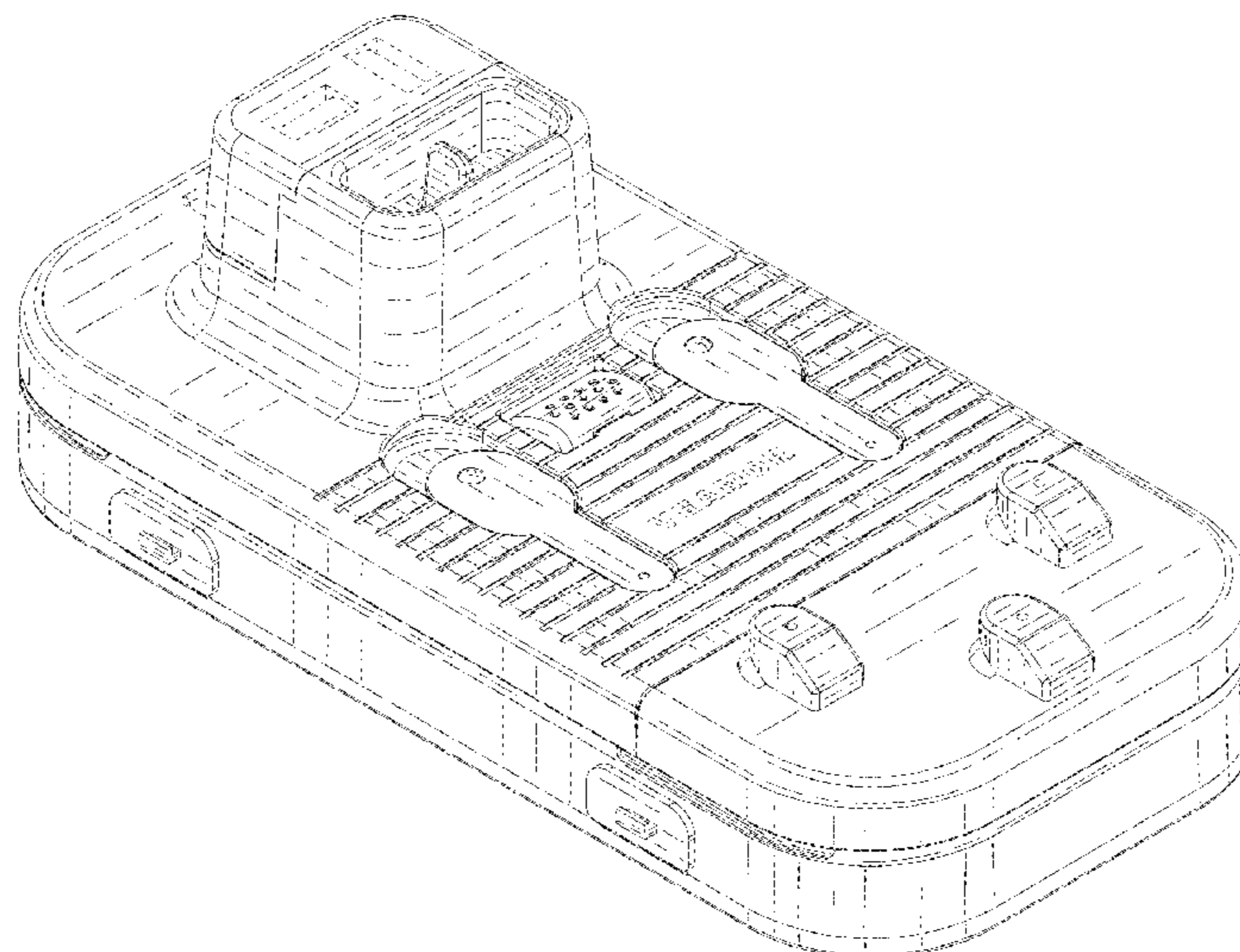

(56)

References Cited

U.S. PATENT DOCUMENTS

10,422,638 B2 * 9/2019 Burge G01C 9/02
10,524,592 B2 * 1/2020 Sergyeyenko B25H 7/04
D895,455 S * 9/2020 Hammond D10/69
D938,244 S * 12/2021 Zhan D10/69
2020/0345158 A1 * 11/2020 Hammond G01C 9/28

* cited by examiner

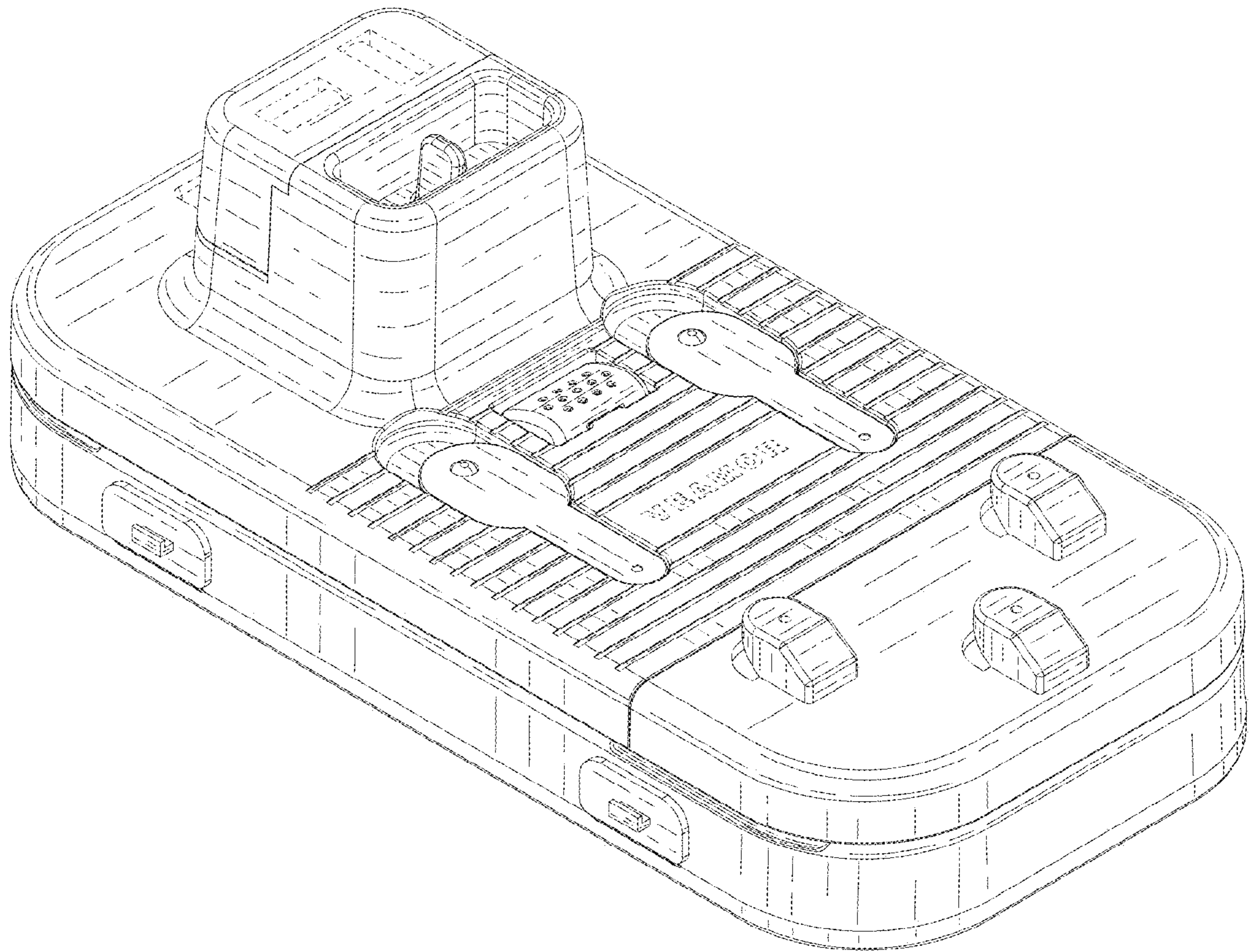

FIG. 1

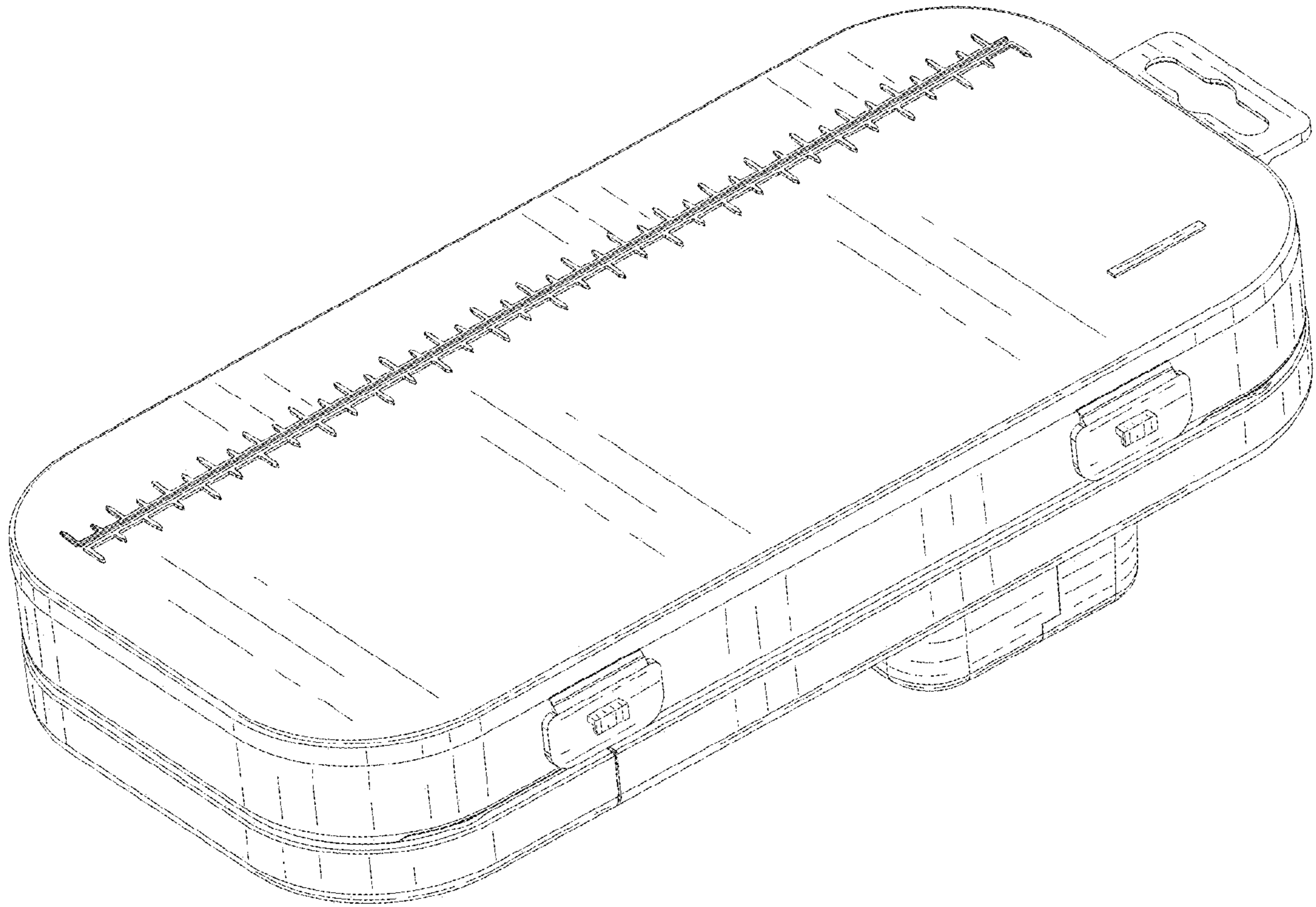

FIG. 2

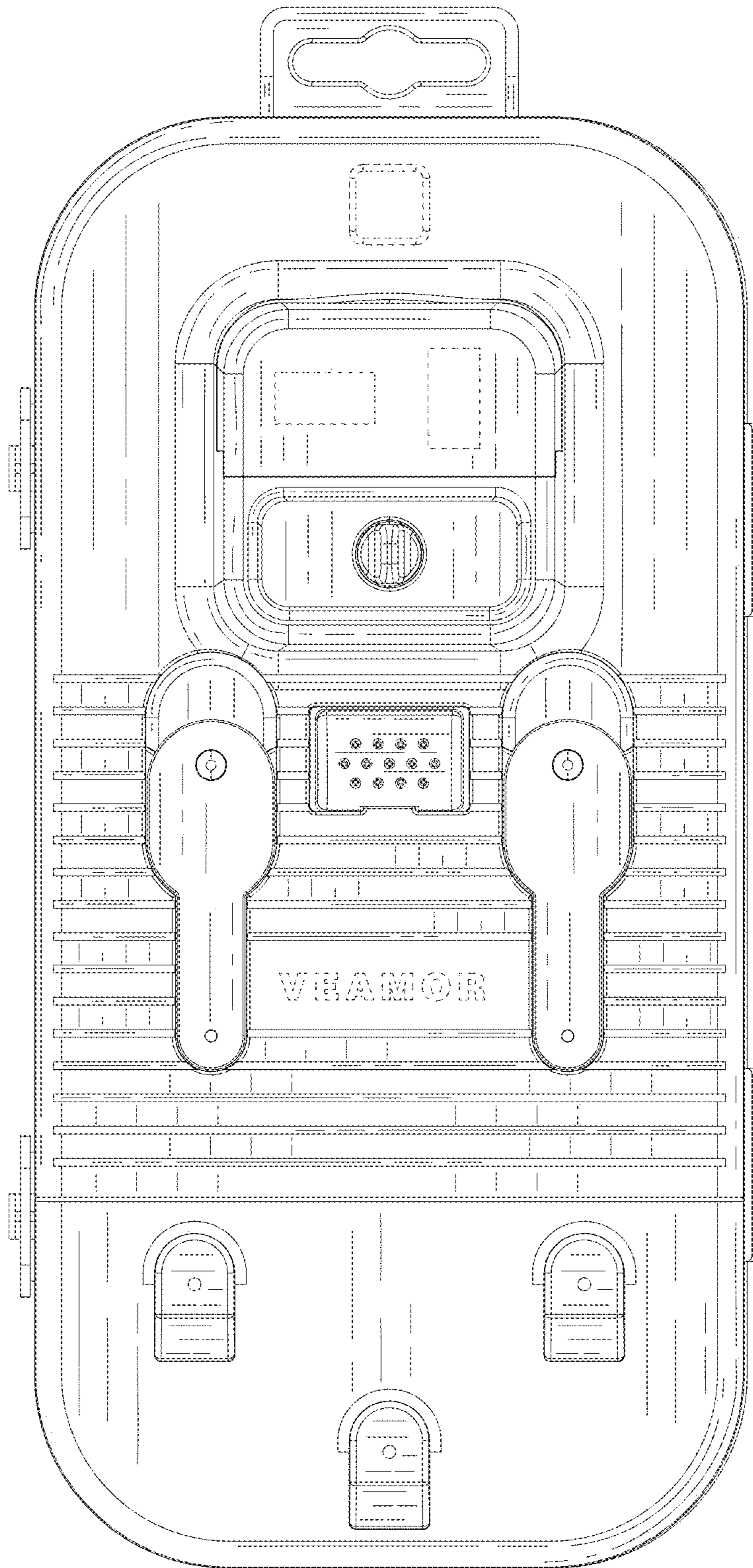

FIG. 3

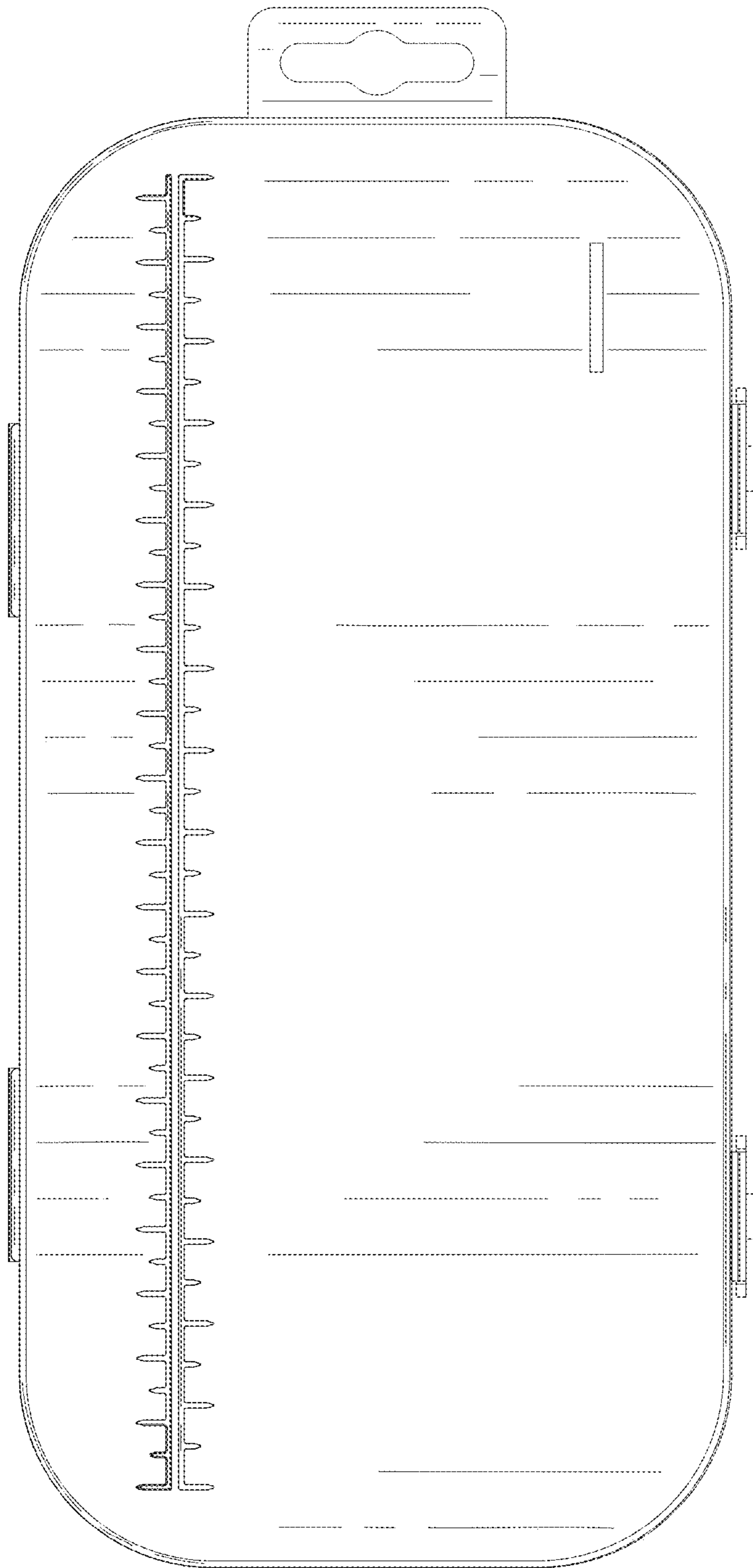

FIG. 4

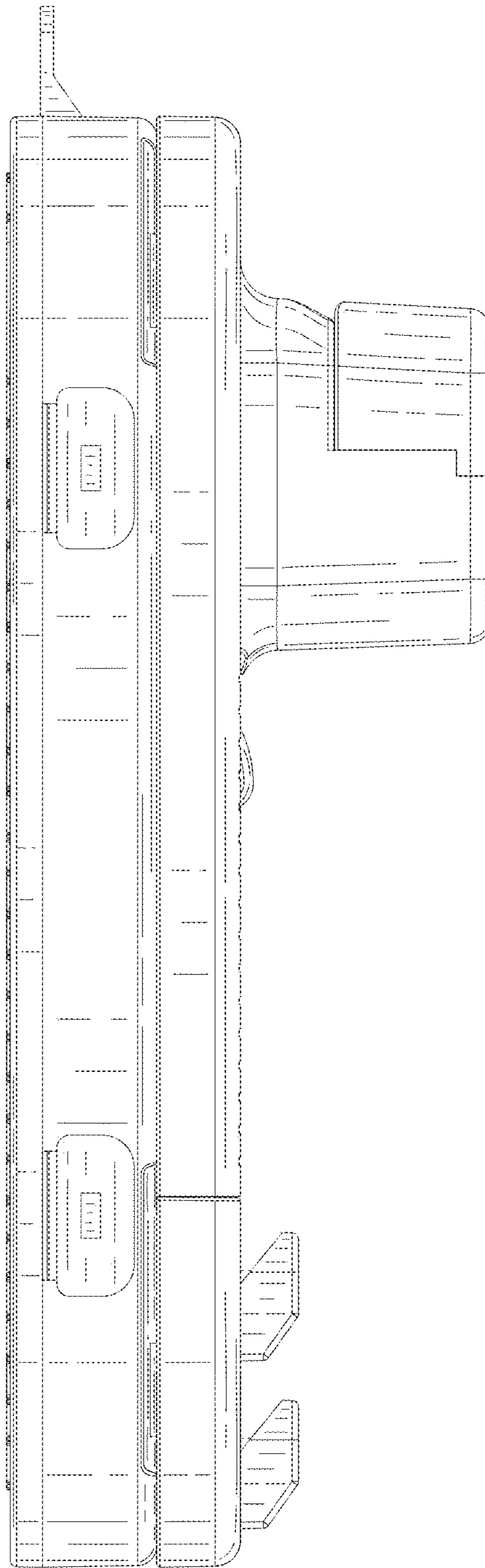

FIG. 5

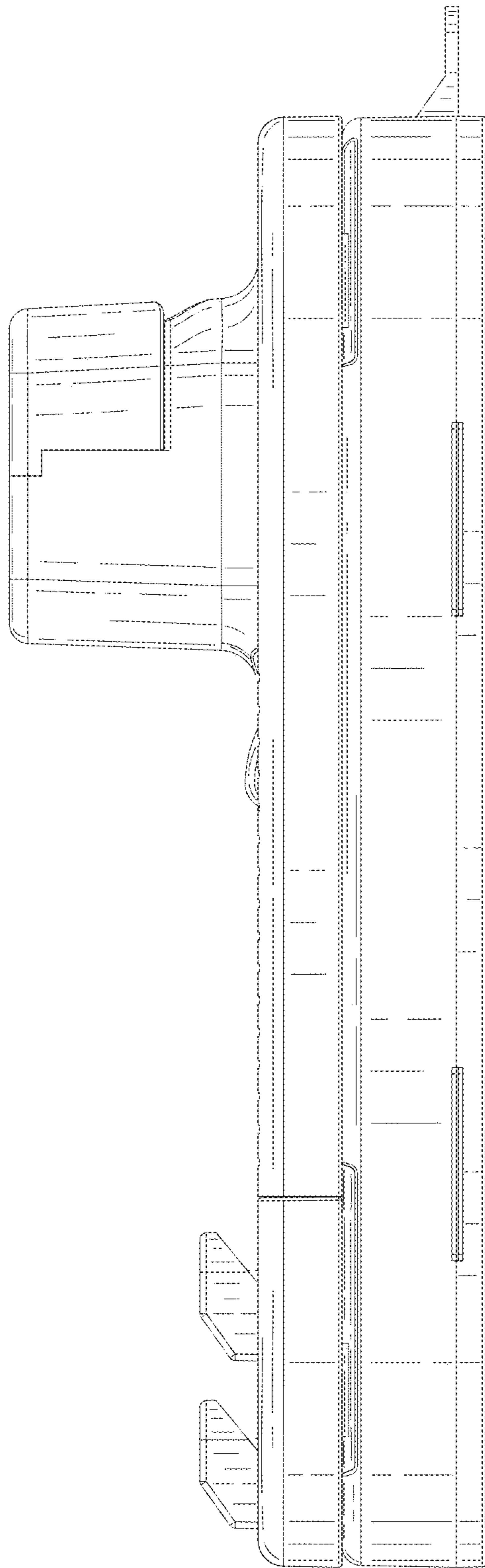

FIG. 6

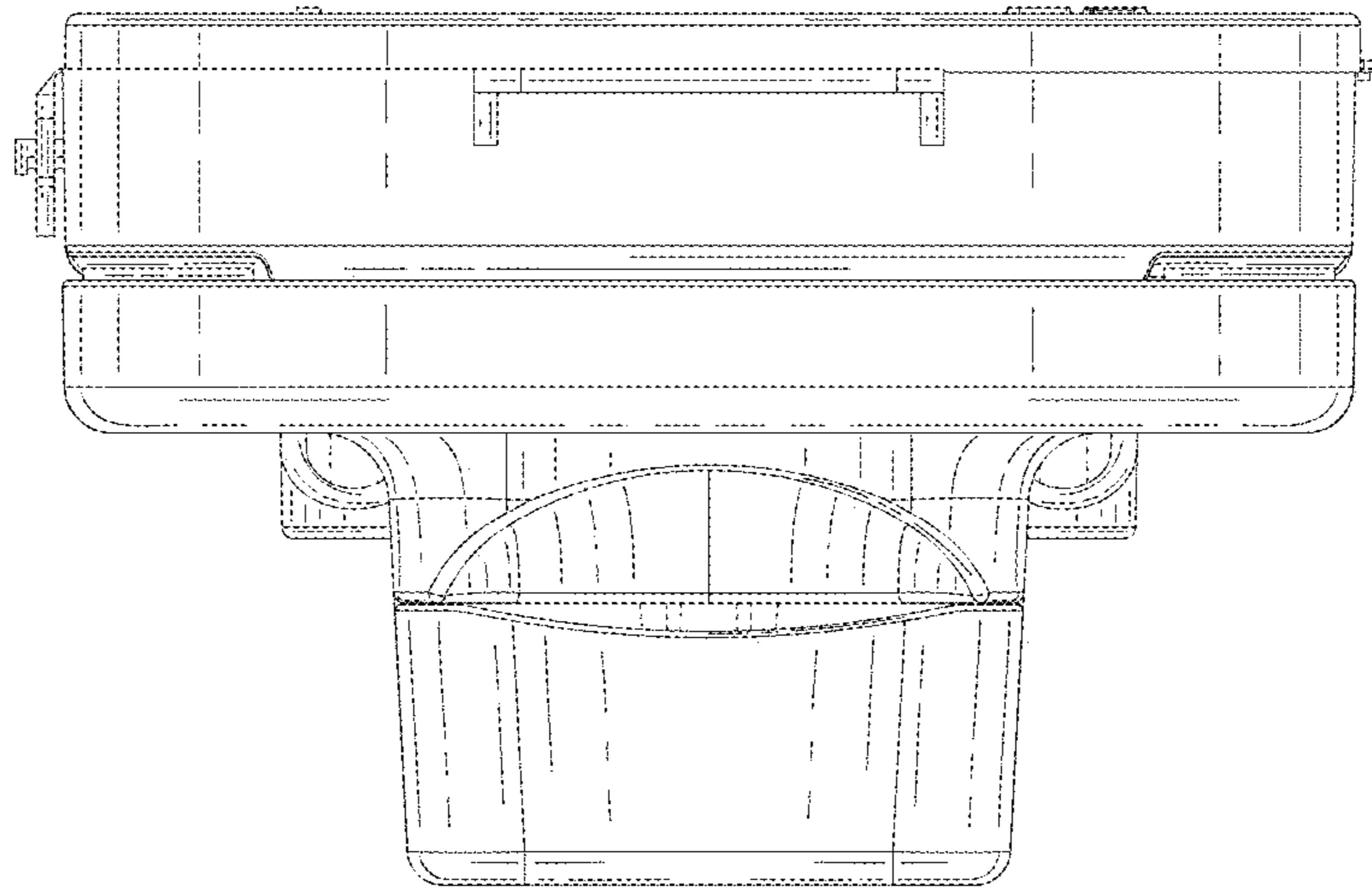

FIG. 7

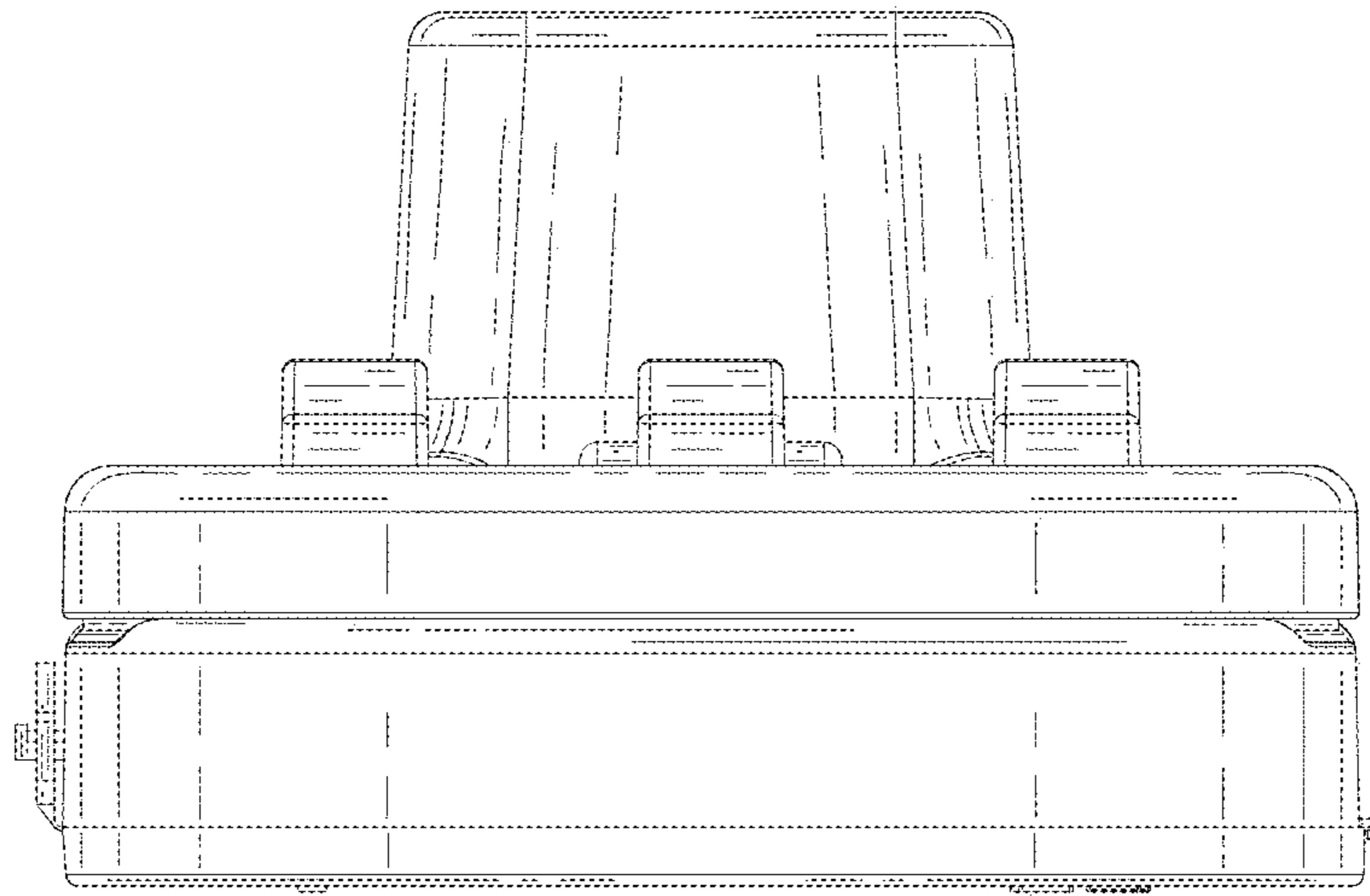

FIG. 8