

US00D974861S

(12) **United States Design Patent** (10) **Patent No.:** **US D974,861 S**
Giles (45) **Date of Patent:** **** *Jan. 10, 2023**

(54) **BASEBALL BOTTLE**
(71) Applicant: **Carleton J Giles**, Columbia, SC (US)
(72) Inventor: **Carleton J Giles**, Columbia, SC (US)

D354,639 S * 1/1995 Stoddard D30/102
D357,500 S * 4/1995 Mutterperl D19/135
D375,226 S * 11/1996 Blankenburg D7/901
D378,562 S * 3/1997 Miller D7/606
D390,778 S * 2/1998 Lee D3/271.9
(Continued)

(*) Notice: This patent is subject to a terminal disclaimer.
(**) Term: **15 Years**

FOREIGN PATENT DOCUMENTS

CN 303894263 * 10/2016
CN 303975863 * 12/2016
(Continued)

(21) Appl. No.: **29/762,117**

(22) Filed: **Dec. 15, 2020**

OTHER PUBLICATIONS

(51) **LOC (14) Cl.** **07-01**
(52) **U.S. Cl.**

Keshishian, Milord A., "Design Patent and Trademark Lawsuit Filed Against Coca Cola Over Sports Ball Shaped Beverage Bottles," Mar. 7, 2010, Milord Law Group, www.iptrademarkattorney.com/patent-attorney-design-trademark-bottles-sports-drink-gt-beverages-coca-cola/ (Year: 2010).*

USPC **D7/901**; D7/509; D7/515; D9/668

(58) **Field of Classification Search**

USPC D3/14, 270, 271.1, 271.9; D4/107, 124; D6/557; D7/301-303, 507, 509-511, D7/514, 518, 606, 613, 619.2, 623, 628, D7/634, 651, 654, 663, 702, 901; D9/500, 519, 537, 539, 608, 646, 668; D11/133, 149, 157; D24/198, 208; D27/120, 148, 165, 171, 177, 178, 182, D27/188, 192
CPC A45F 3/16; A45F 3/18; A47F 2003/16; A47G 19/2205; A47G 19/2227; A47G 19/2272; A47G 19/2288; A47G 2019/122; B65D 1/02; B65D 23/00; B65D 23/08; B65D 23/012; B65D 81/38; B65D 85/72

(Continued)

Primary Examiner — Joseph Kukella
Assistant Examiner — Arva P Adams
(74) *Attorney, Agent, or Firm* — Southeast IP Group; Thomas L. Moses

See application file for complete search history.

(57) **CLAIM**

The ornamental design for a baseball bottle, as shown and described.

(56) **References Cited**

U.S. PATENT DOCUMENTS

D166,731 S * 5/1952 Blunt D9/500
D283,009 S * 3/1986 Jennette D9/668
D286,940 S * 12/1986 Saladino D7/901
D286,941 S * 12/1986 Saladino D7/901
D287,767 S * 1/1987 Simmons D7/901
5,158,190 A * 10/1992 Sosenko B65D 23/102
215/371

DESCRIPTION

FIG. 1 is a front view of a baseball bottle showing my new design;
FIG. 2 is a right side view thereof.
FIG. 3 is a left side view thereof.
FIG. 4 is a rear view thereof.
FIG. 5 is a top plan view thereof; and,
FIG. 6 is a bottom plan view thereof.
The broken lines illustrate portions of the baseball bottle that forms no part of the claimed design.

1 Claim, 5 Drawing Sheets

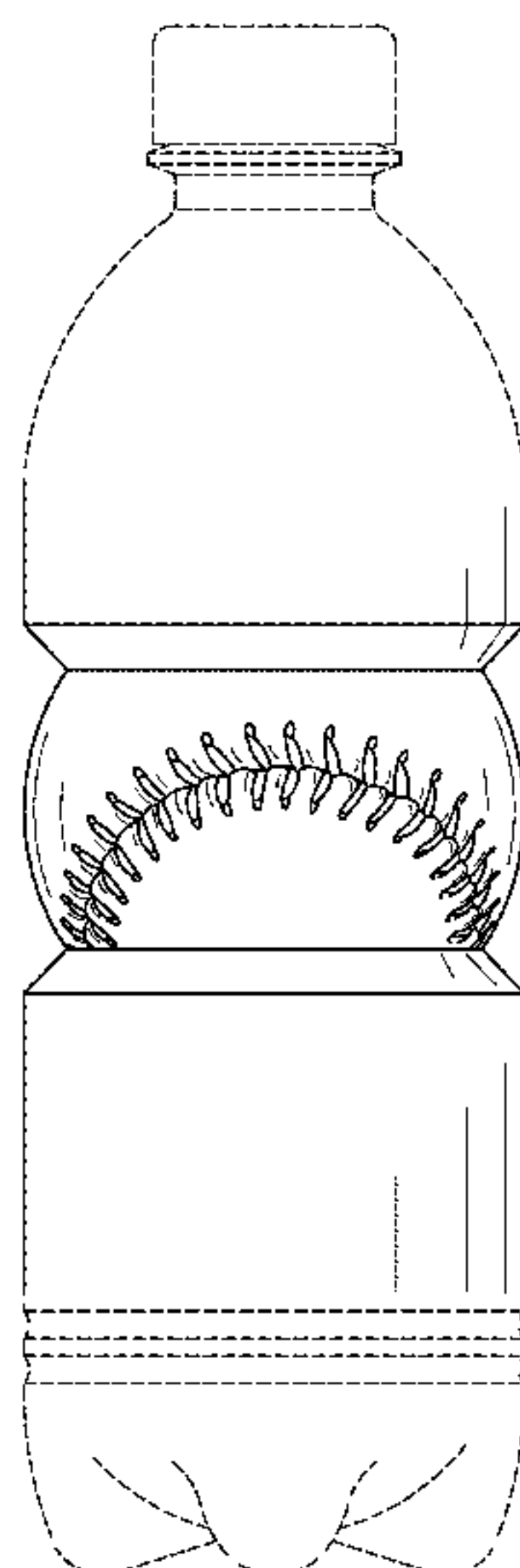

(56)

References Cited

U.S. PATENT DOCUMENTS

D400,395 S * 11/1998 Wilson D7/396.2
5,906,286 A * 5/1999 Matsuno B29C 49/12
220/675
D416,173 S * 11/1999 Hersch D7/514
D427,057 S * 6/2000 Roth D7/901
D427,514 S * 7/2000 Roth D7/901
D447,172 S * 8/2001 Cohen D19/155
D473,469 S * 4/2003 Claessen D9/539
D499,554 S * 12/2004 Ramelli D4/138
D511,654 S * 11/2005 Bailey D7/901
D549,107 S * 8/2007 Bourne D9/554
D586,187 S * 2/2009 Sax D7/606
D594,702 S * 6/2009 Sax D7/901
D604,178 S * 11/2009 Bowyer D9/500
D642,479 S * 8/2011 Azar D9/668
D664,860 S * 8/2012 Gelin D9/668
D665,265 S * 8/2012 Fonseca D9/668
D666,455 S * 9/2012 Levin D7/392.1
D671,011 S * 11/2012 Sanders D9/668
D673,225 S * 12/2012 Heidrich D21/400
D688,041 S * 8/2013 Kroupa D3/264
D691,896 S * 10/2013 Martin D9/668
D705,077 S * 5/2014 Martin D9/551

D740,130 S * 10/2015 Martin D9/668
D741,194 S * 10/2015 Martin D9/551
D761,660 S * 7/2016 Giles D9/668
D762,124 S * 7/2016 Giles B29C 49/12
D9/668
D762,482 S * 8/2016 Giles D9/539
D893,310 S * 8/2020 Eble D4/125

FOREIGN PATENT DOCUMENTS

GR 6003834-0001 * 2/2015
RU 00046528 * 12/1999
RU 00066667 * 6/2008

OTHER PUBLICATIONS

PlatesPlus For Kids, "Cool Gear Baseball Water Bottle with Freezer Stick," Jan. 5, 2018, Amazon.com, www.amazon.com/Cool-Gear-BaseballWater-Bottle-Freezer/dp/B00FX1OQ2O (Year: 2018).*
Maccabi Art, "Maccabi Art Clip-On Collapsible BPA-Free Silicone Baseball Water Bottle for Kids," Jul. 21, 2020, Amazon.com, www.amazon.com/Collapsible-Silicone-Baseball-Water-Bottle/dp/B08DDHXY74 (Year: 2020).*

* cited by examiner

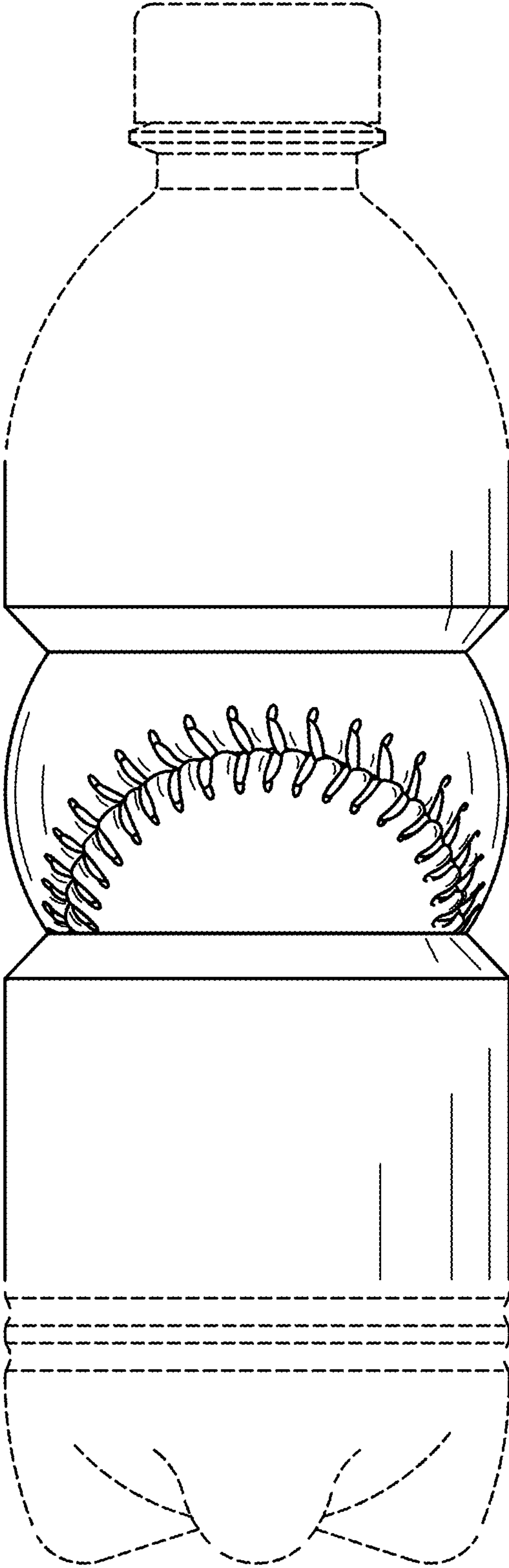

FIG. 1

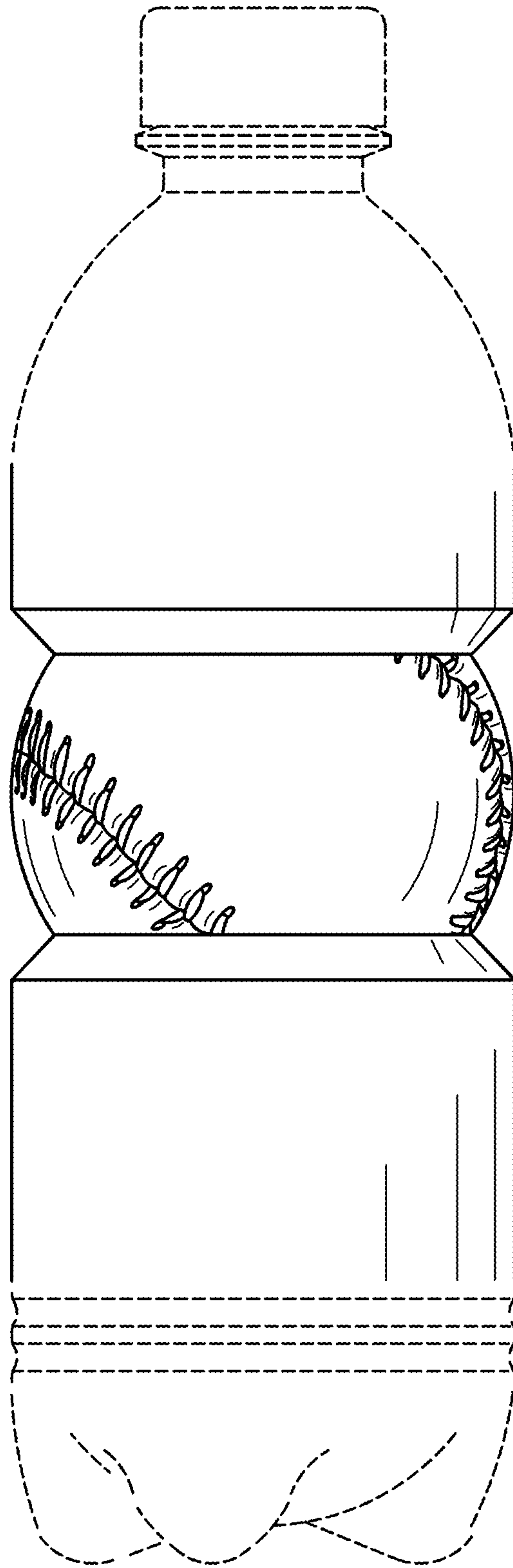

FIG. 2

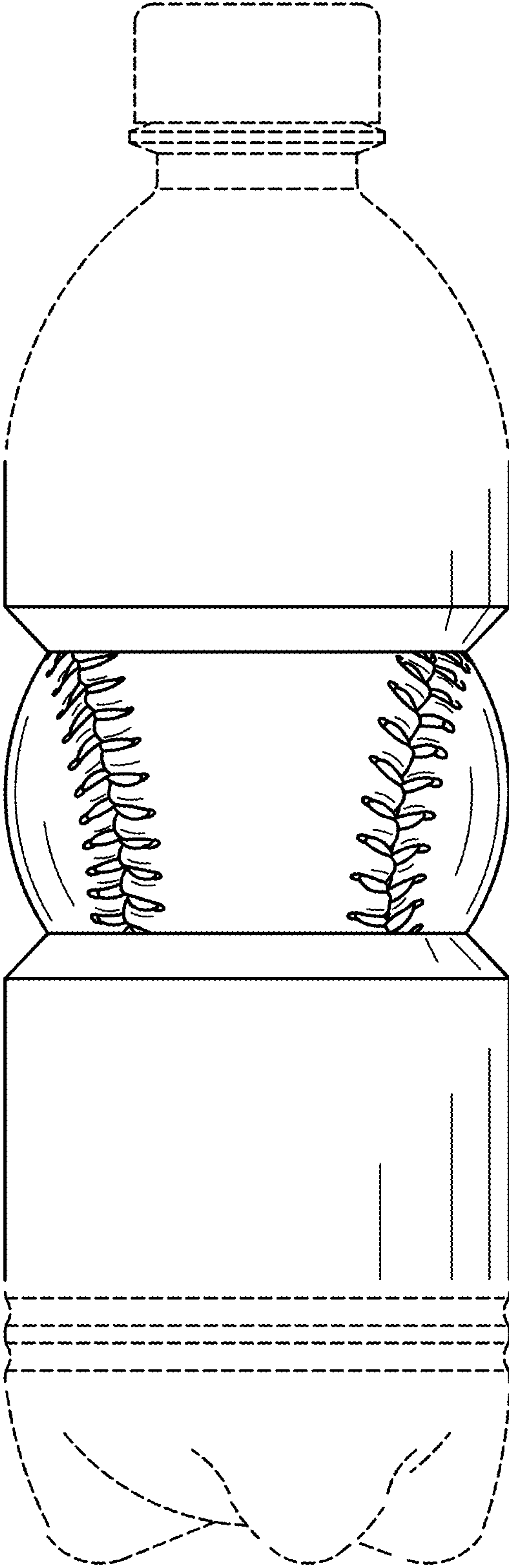

FIG. 3

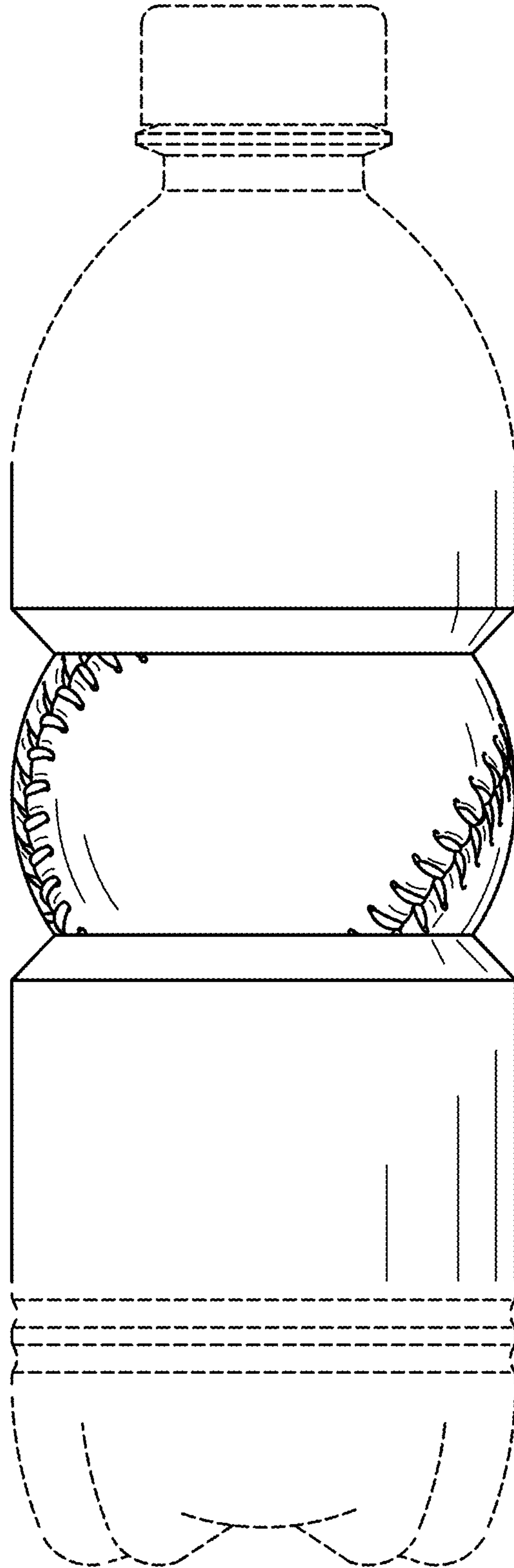

FIG. 4

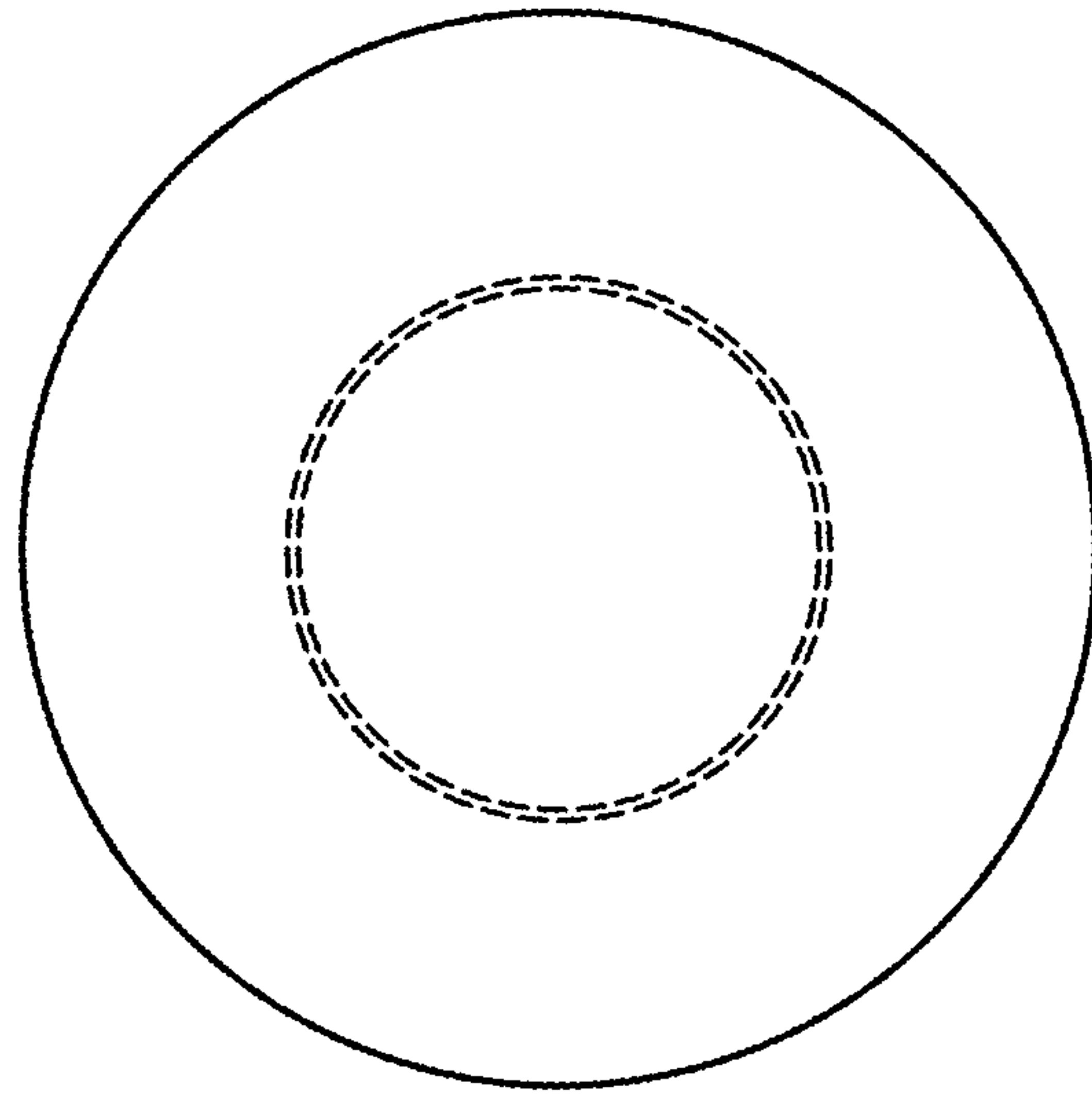

FIG. 5

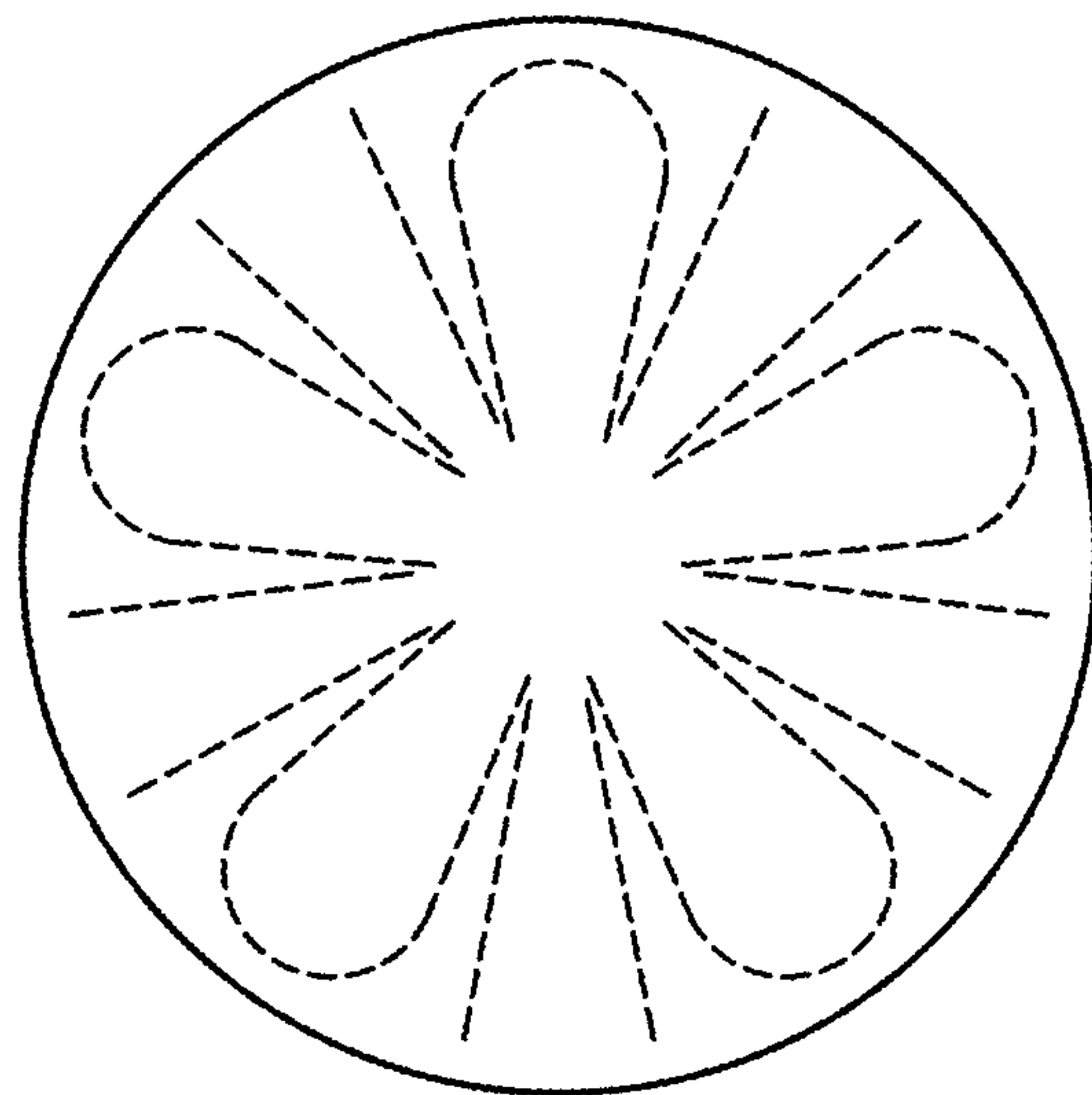

FIG. 6