



US00D974803S

(12) **United States Design Patent**
Shi

(10) **Patent No.:** **US D974,803 S**
(45) **Date of Patent:** **** Jan. 10, 2023**

(54) **HAMMER SHAPE CLAMP LEG PILLOW**

10,602,850 B2 * 3/2020 Green A61F 5/3761
D896,550 S * 9/2020 Cane D6/601
D915,792 S * 4/2021 Shi D6/601

(71) Applicant: **Chunxia Shi**, Yancheng (CN)

(72) Inventor: **Chunxia Shi**, Yancheng (CN)

(**) Term: **15 Years**

(21) Appl. No.: **29/749,063**

(22) Filed: **Sep. 2, 2020**

(30) **Foreign Application Priority Data**

Mar. 11, 2020 (CN) 202030079069.4

(51) **LOC (14) Cl.** **06-13**

(52) **U.S. Cl.**
USPC **D6/597**; D6/601

(58) **Field of Classification Search**
USPC D6/595, 596, 597, 601, 604; D8/75, 78;
D24/190

CPC .. A47C 2020/021; A47G 9/10; A47G 9/1063;
A47G 2009/003; A61H 2201/1602

See application file for complete search history.

(56) **References Cited**

U.S. PATENT DOCUMENTS

- 1,973,240 A * 9/1934 Proudfit A01N 1/00
5/636
- D211,244 S * 6/1968 Hawley D6/601
- D318,203 S * 7/1991 Zaghini 5/636
- D319,751 S * 9/1991 Hoff D6/601
- D340,380 S * 10/1993 McDonald D6/601
- D349,541 S * 8/1994 Bertolucci A63B 23/0482
D6/601
- 6,179,756 B1 * 1/2001 Bertolucci A63B 23/0488
482/131
- D622,123 S * 8/2010 Zubiaurre Alberdi D8/78
- D639,101 S * 6/2011 Kalatsky D6/601
- D725,407 S * 3/2015 McCracken D6/601

FOREIGN PATENT DOCUMENTS

GB 6060130 * 5/2019

OTHER PUBLICATIONS

Zoan Knee Pillows, Amazon Product Page. Date of Oldest Review: Oct. 20, 2019, Date Accessed: Oct. 4, 2022. Available on the Internet URL: <https://www.amazon.com/ZOAN-Professional-Pregnancy-Circulation-Removable/dp/B07TNXHW56/> (Year: 2019).*

* cited by examiner

Primary Examiner — S. Bryan Reinholdt, Jr.
Assistant Examiner — Julia S Folkart

(57) **CLAIM**

The ornamental design for a hammer shape clamp leg pillow, as shown and described.

DESCRIPTION

FIG. 1 is a perspective view of a hammer shape clamp leg pillow showing my new design;
FIG. 2 is a front view thereof;
FIG. 3 is a rear view thereof;
FIG. 4 is a left side view thereof;
FIG. 5 is a right side view thereof;
FIG. 6 is a top plan view thereof; and,
FIG. 7 is a bottom plan view thereof.

1 Claim, 7 Drawing Sheets

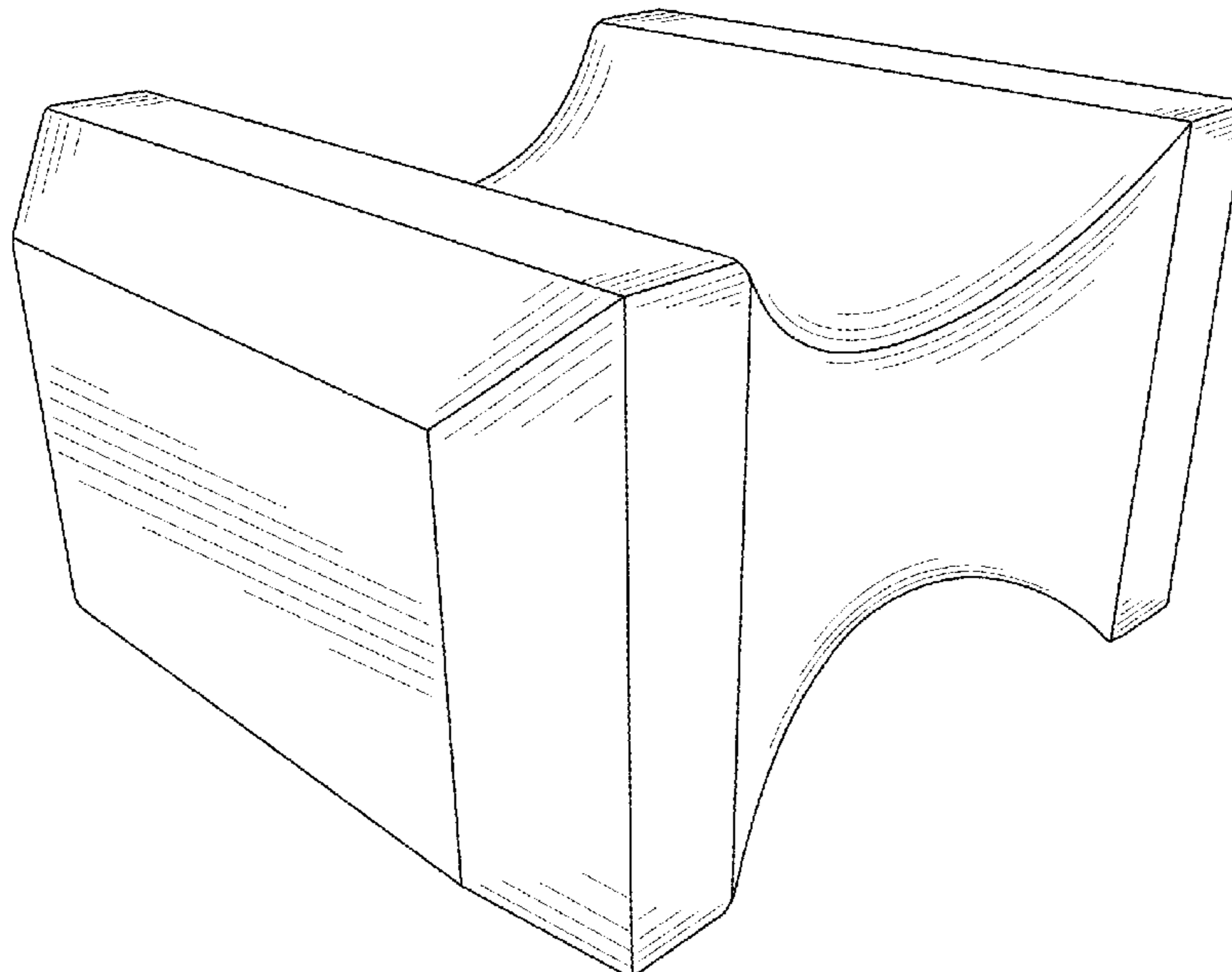

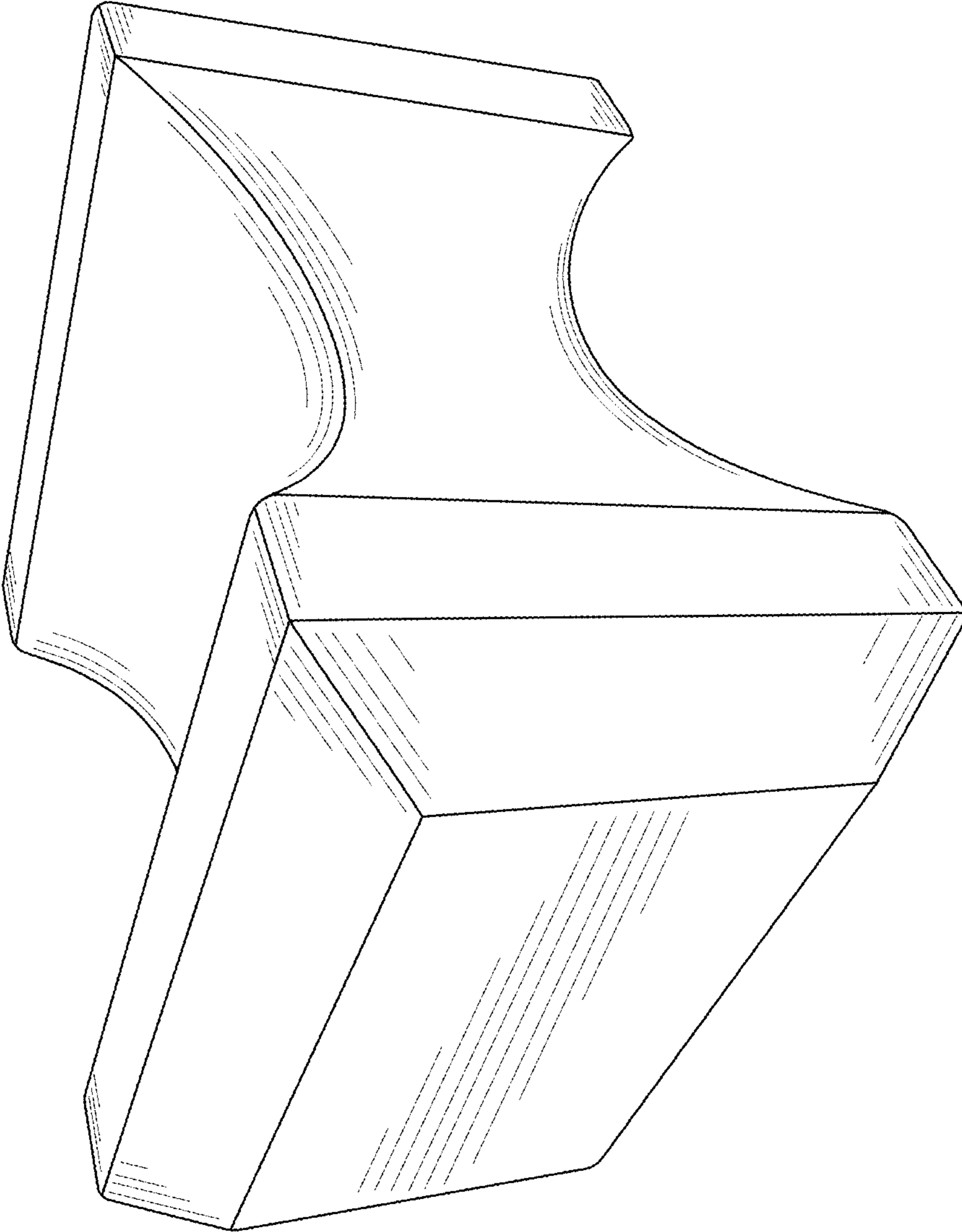

FIG.1

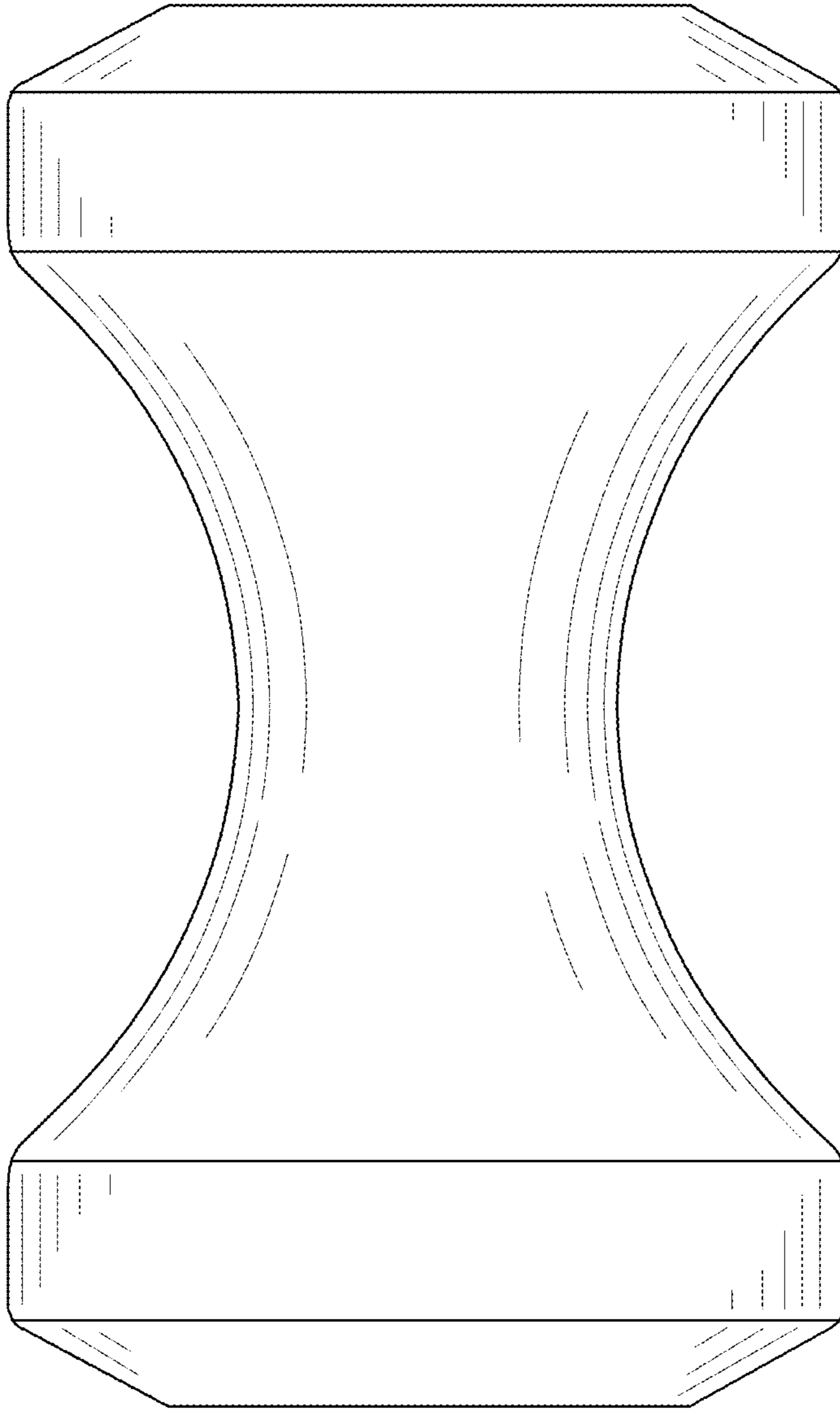

FIG.2

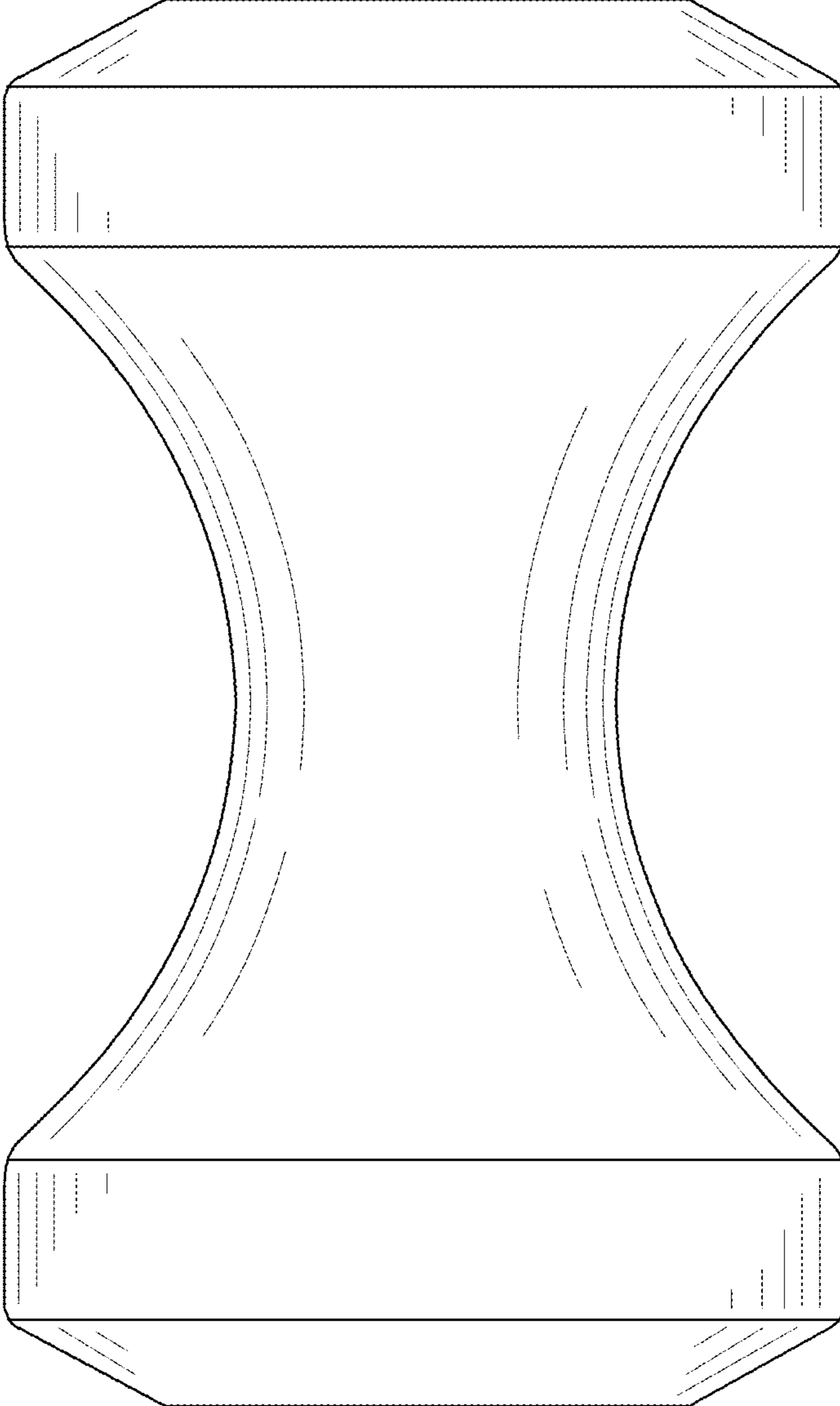

FIG. 3

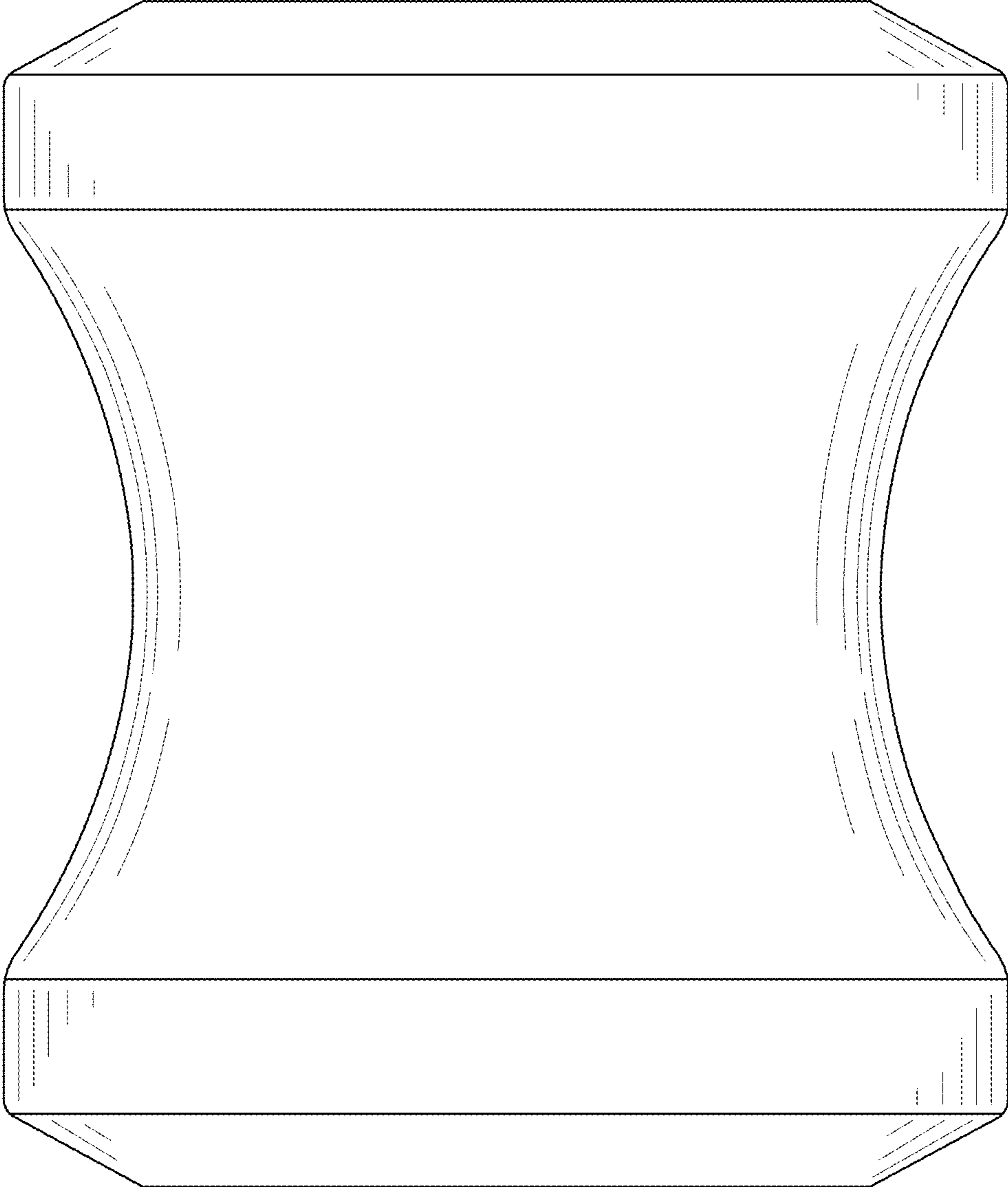

FIG.4

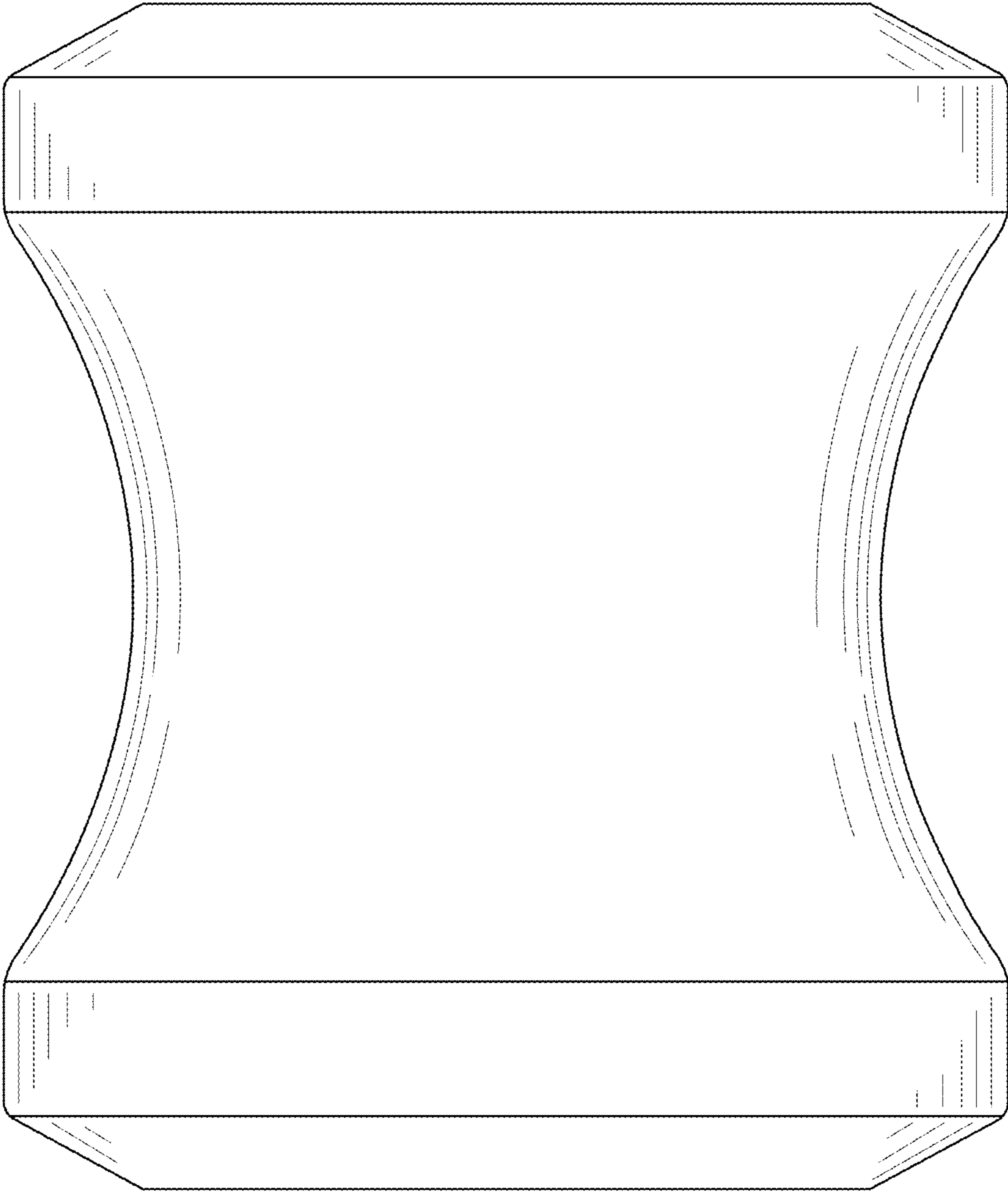

FIG. 5

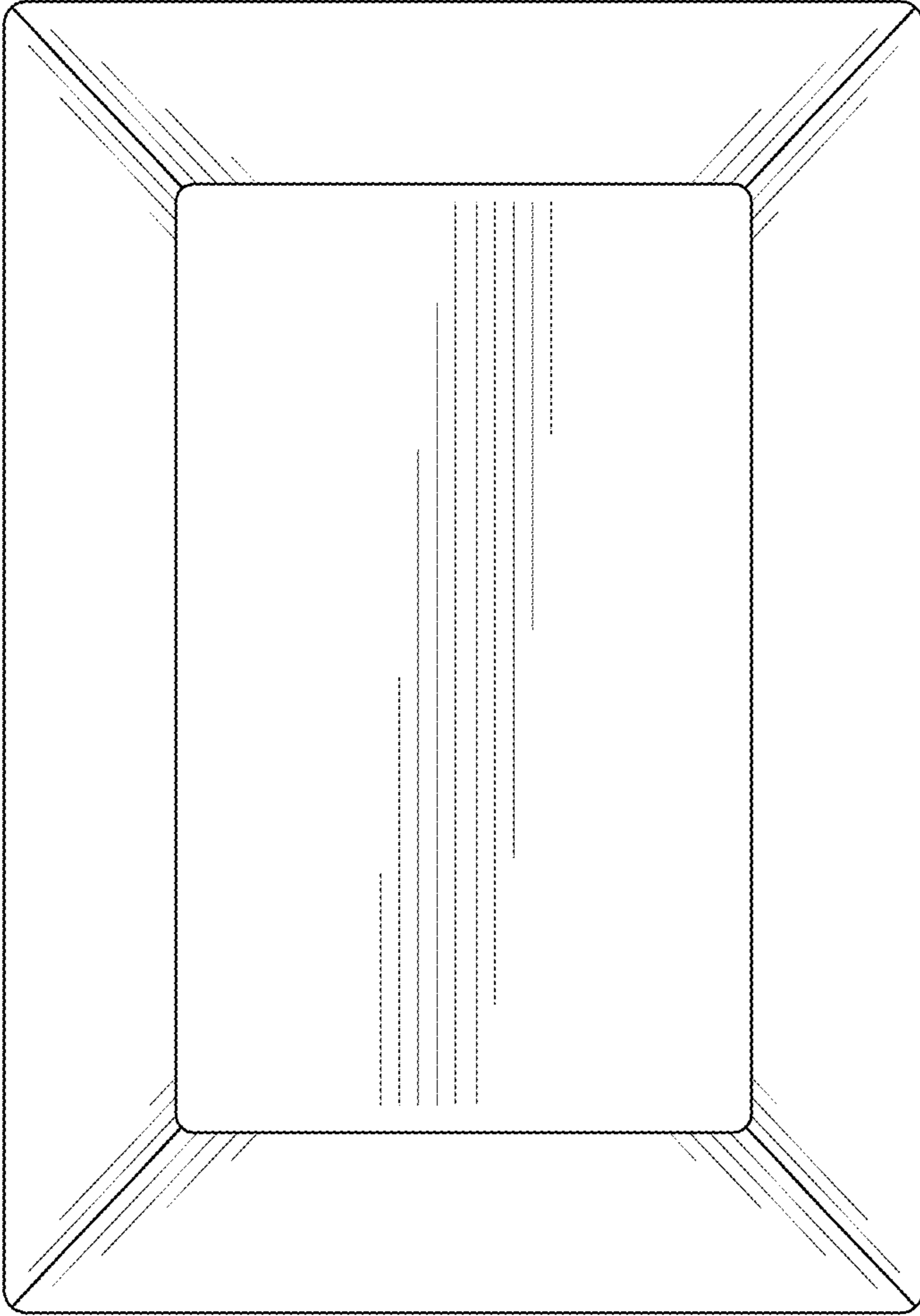

FIG.6

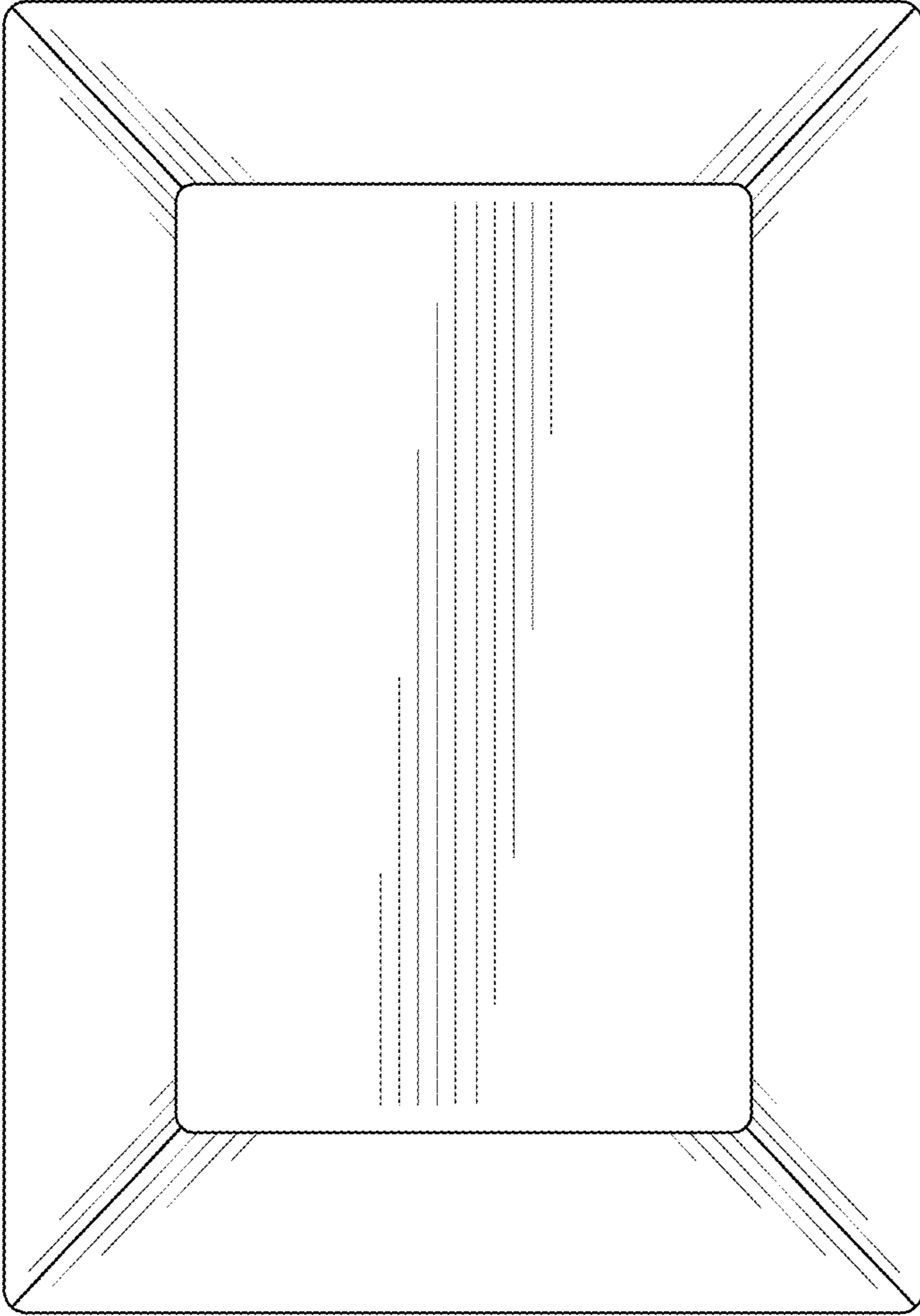

FIG. 7