



US00D974584S

(12) **United States Design Patent**  
**Wang**

(10) **Patent No.:** **US D974,584 S**  
(45) **Date of Patent:** **\*\* Jan. 3, 2023**

(54) **VIBRATOR**

(71) Applicant: **Fenghua Wang**, Mingguang (CN)

(72) Inventor: **Fenghua Wang**, Mingguang (CN)

(\*\*) Term: **15 Years**

(21) Appl. No.: **29/805,705**

(22) Filed: **Aug. 30, 2021**

(51) **LOC (14) Cl.** ..... **28-03**

(52) **U.S. Cl.**  
USPC ..... **D24/215**

(58) **Field of Classification Search**  
USPC ..... D24/200, 211, 212, 213, 214, 215  
CPC ..... A61H 19/00; A61H 19/34; A61H 19/40;  
A61H 19/50; A61H 2205/087; A61H  
2201/0153

See application file for complete search history.

(56) **References Cited**

**U.S. PATENT DOCUMENTS**

D523,562 S *	6/2006	Telford	.....	D24/215
D681,222 S *	4/2013	Chen	.....	D24/215
D788,934 S *	6/2017	Hirokawa	.....	D24/215
D818,601 S *	5/2018	Cheung	.....	D24/215
D856,525 S *	8/2019	Dunham	.....	D24/215
D857,223 S *	8/2019	Nagata	.....	D24/215
D861,187 S *	9/2019	Fuhner	.....	D24/215
D869,675 S *	12/2019	Hitscherich	.....	D24/215
D870,903 S *	12/2019	Weisman	.....	D24/200
D898,211 S *	10/2020	Lampert	.....	D24/215
D898,214 S	10/2020	Zhou	.....	
D908,910 S *	1/2021	Lampert	.....	D24/215
D927,721 S *	8/2021	Dumler	.....	D24/215
D939,102 S *	12/2021	Niedermann	.....	D24/215

D950,755 S *	5/2022	Yzusqui Burkard	.....	D24/215
D950,764 S *	5/2022	Dumler	.....	D24/215
2014/0171841 A1 *	6/2014	Kazaryan	.....	A61H 19/40 601/46

**OTHER PUBLICATIONS**

Amazon, "Wearable Vibrator", Date First Available Feb. 18, 2022. <https://www.amazon.com/Wearable-Vibrator-Butterfly-Vibration-Waterproof/dp/B09SV1MBB6>. Shown on p. 1. (Year: 2022).\*  
Walmart, "Liyafei Wearable Vibrator", Access date Aug. 1, 2022. <https://www.walmart.com/ip/liyafei-APP-Remote-Control-Wearable-Vibrator-Clitoral-Butterfly-Vibrator-Remote-Control-Clitoral-Couple-Vibrator-with-9-Vibration-Modes/1163751263?athbdg=L1700>. Shown on p. 1. (Year: 2022).\*

\* cited by examiner

*Primary Examiner* — Michael A Maharajh

(57) **CLAIM**

The ornamental design for a vibrator, as shown and described.

**DESCRIPTION**

FIG. 1 is a front and top perspective view of a vibrator, showing my new design;  
FIG. 2 is a rear and bottom perspective view thereof;  
FIG. 3 is a front elevation view thereof;  
FIG. 4 is a rear elevation view thereof;  
FIG. 5 is a left side elevation view thereof;  
FIG. 6 is a right side elevation view thereof;  
FIG. 7 is a top plan view thereof; and,  
FIG. 8 is a bottom plan view thereof.  
The broken lines in the figures illustrate portions of the vibrator that form no part of the claimed design.

**1 Claim, 8 Drawing Sheets**

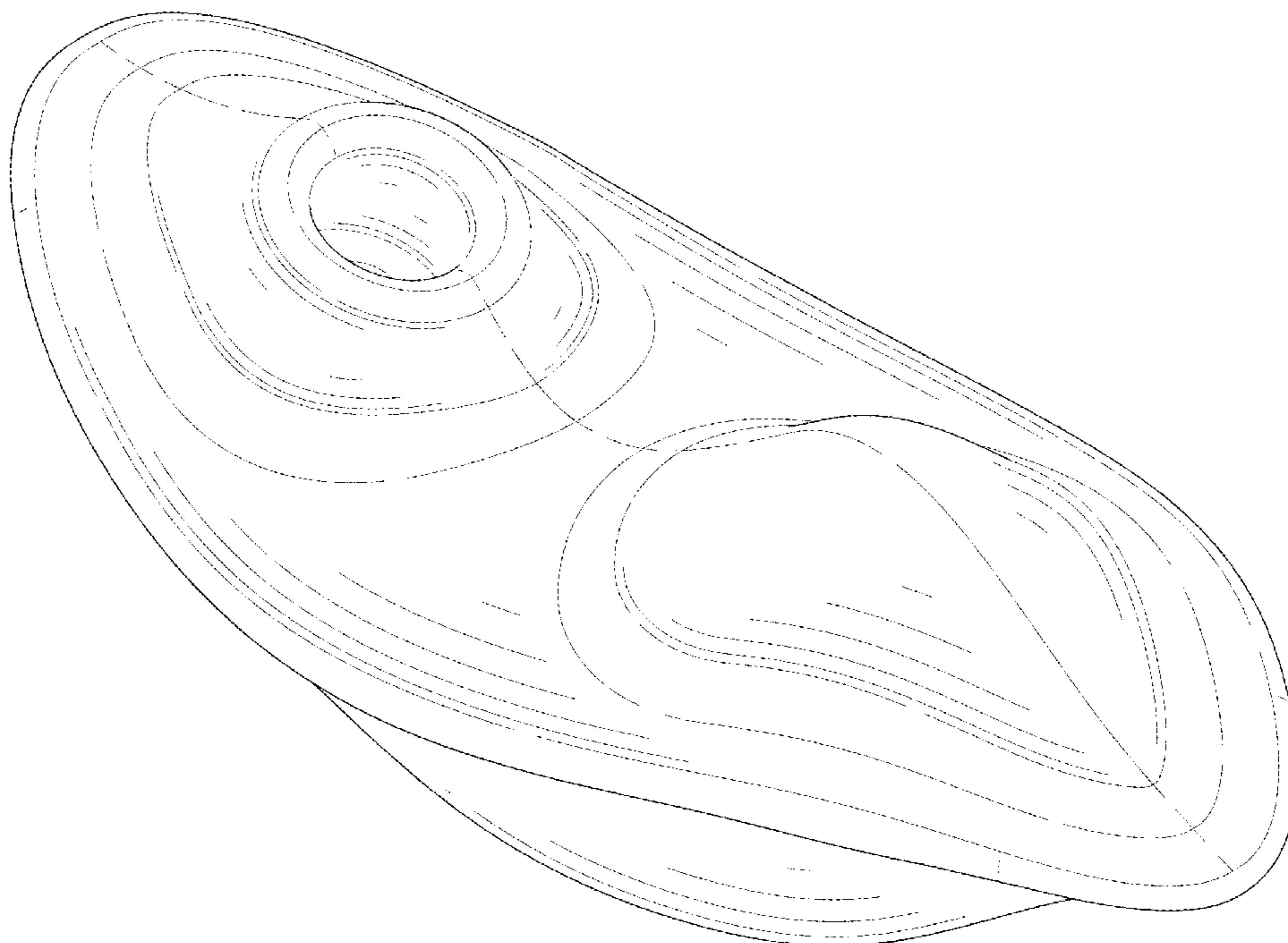

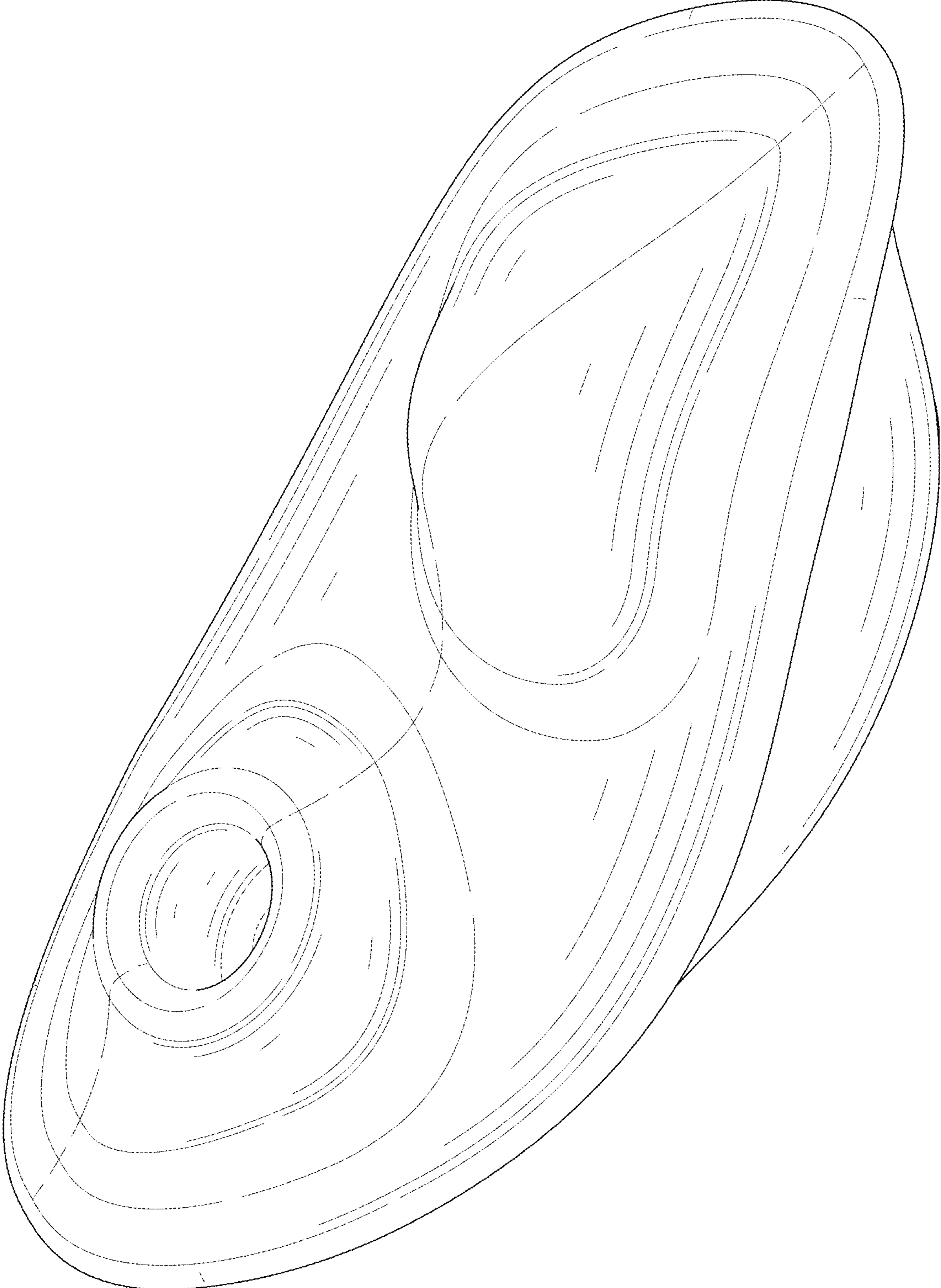

FIG. 1

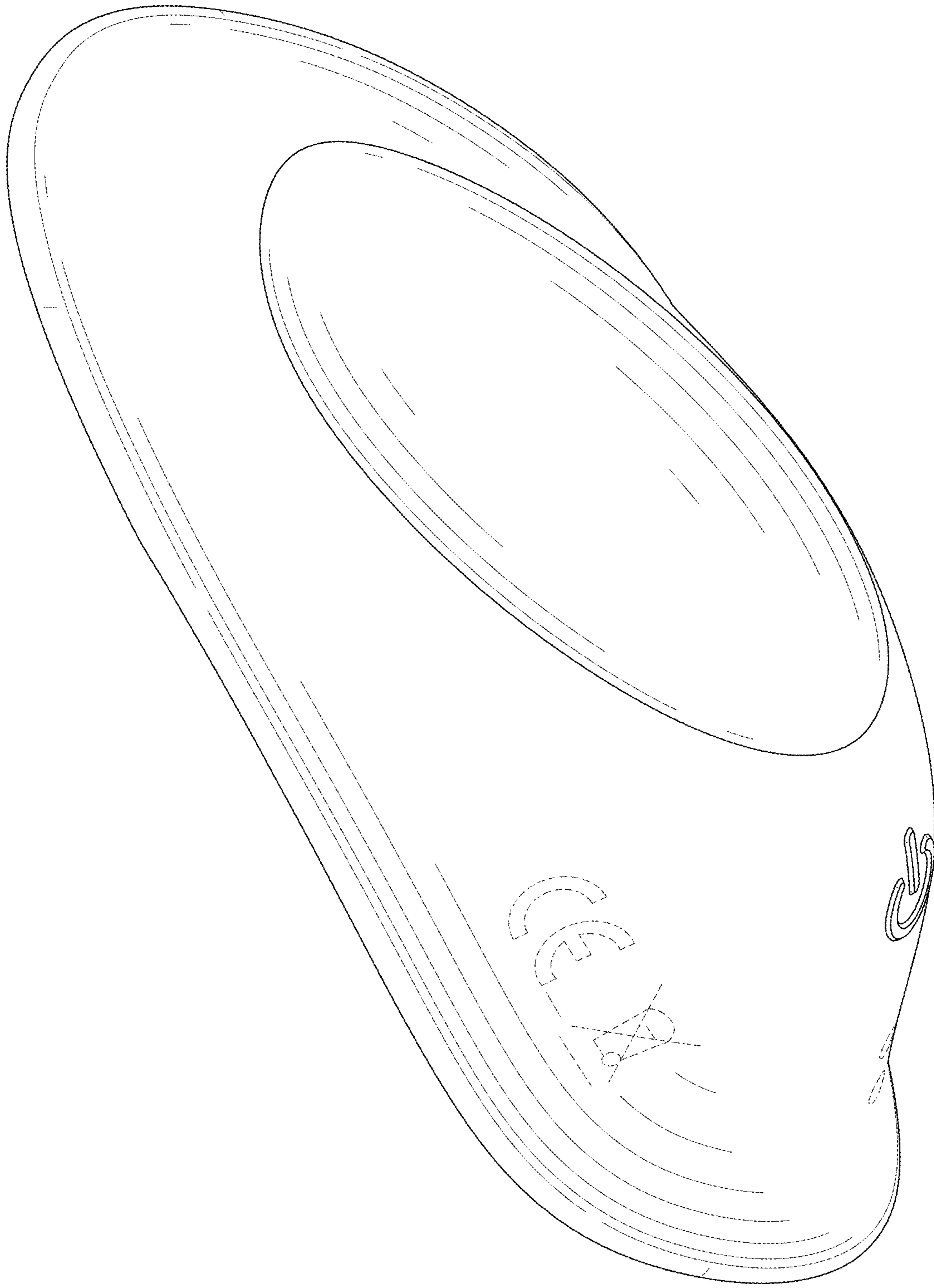

FIG. 2



FIG. 3



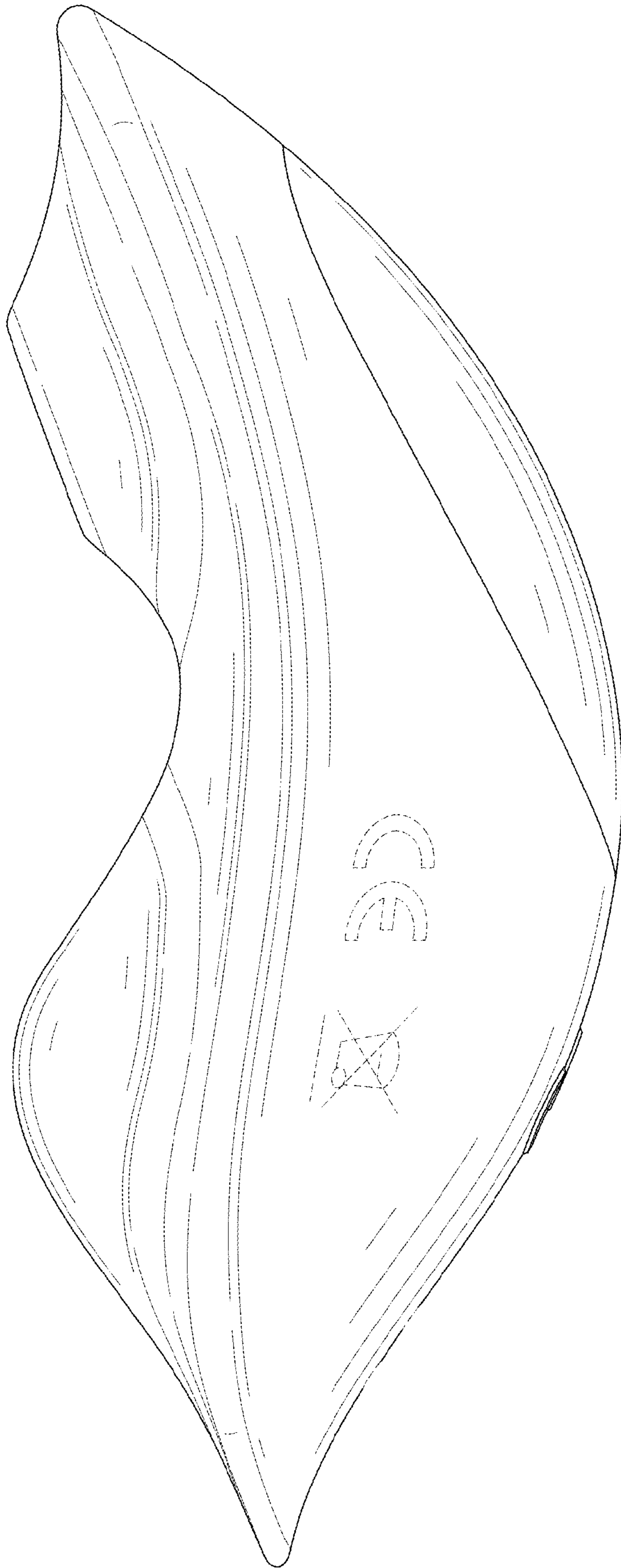

FIG. 4

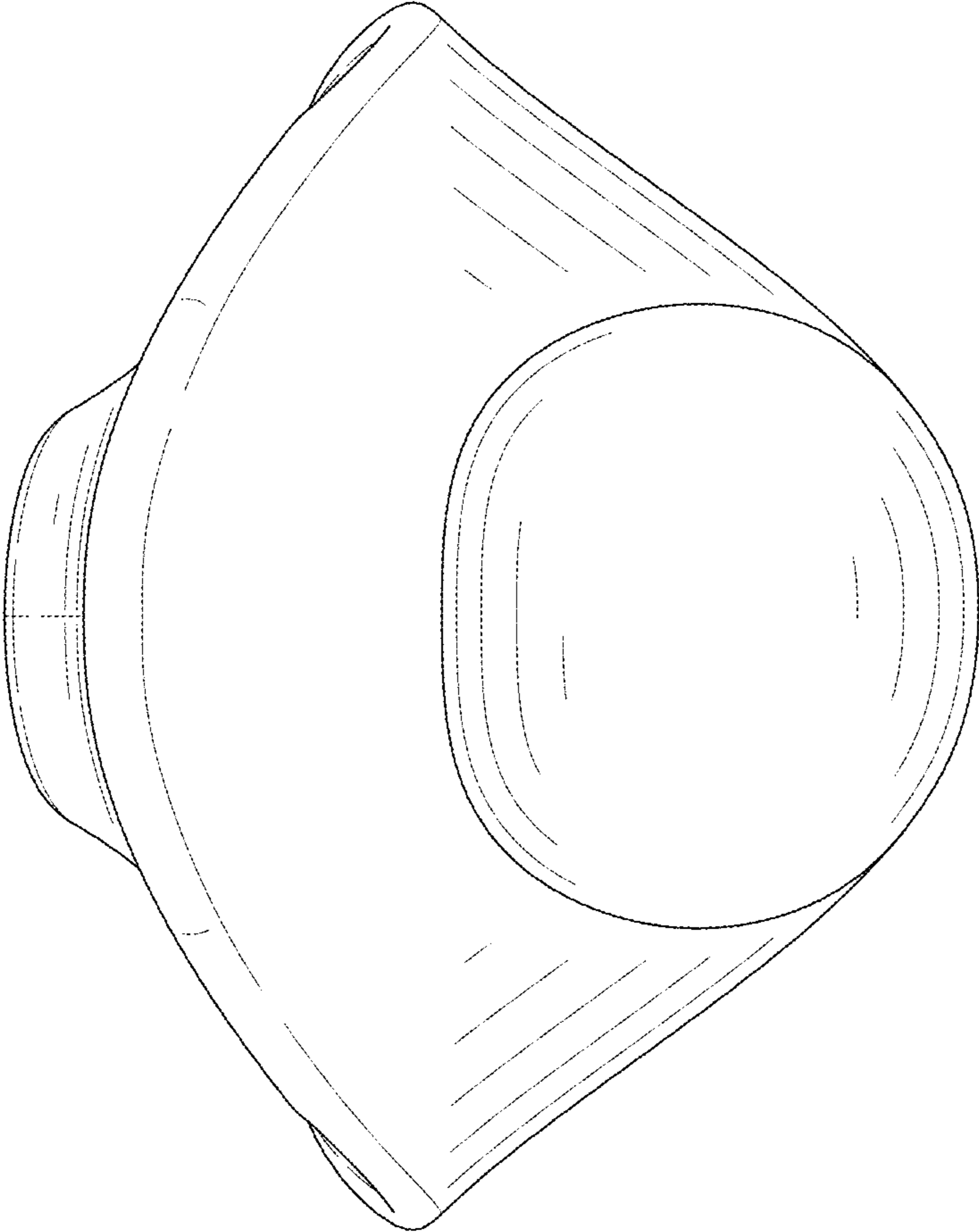

FIG. 5

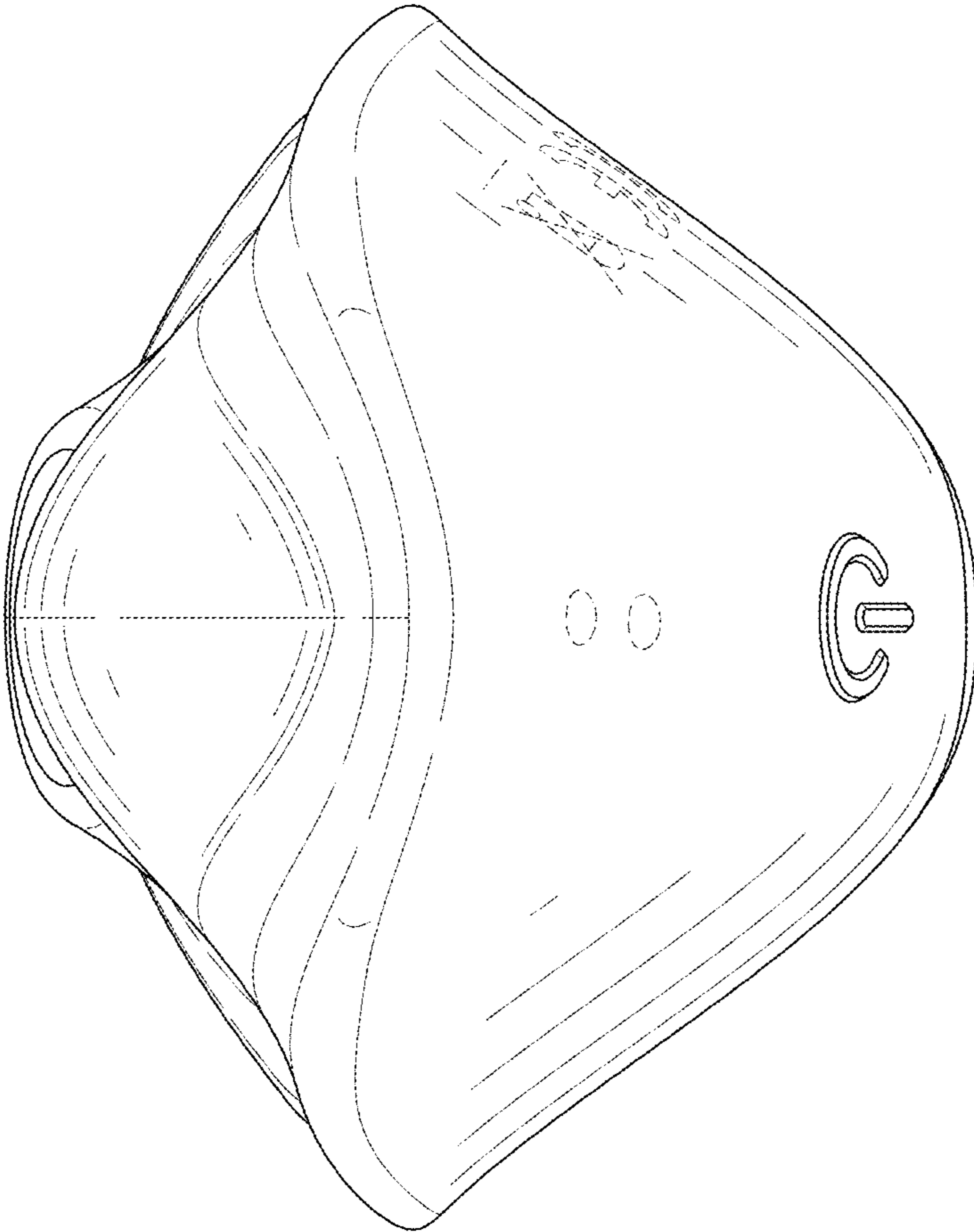

FIG. 6

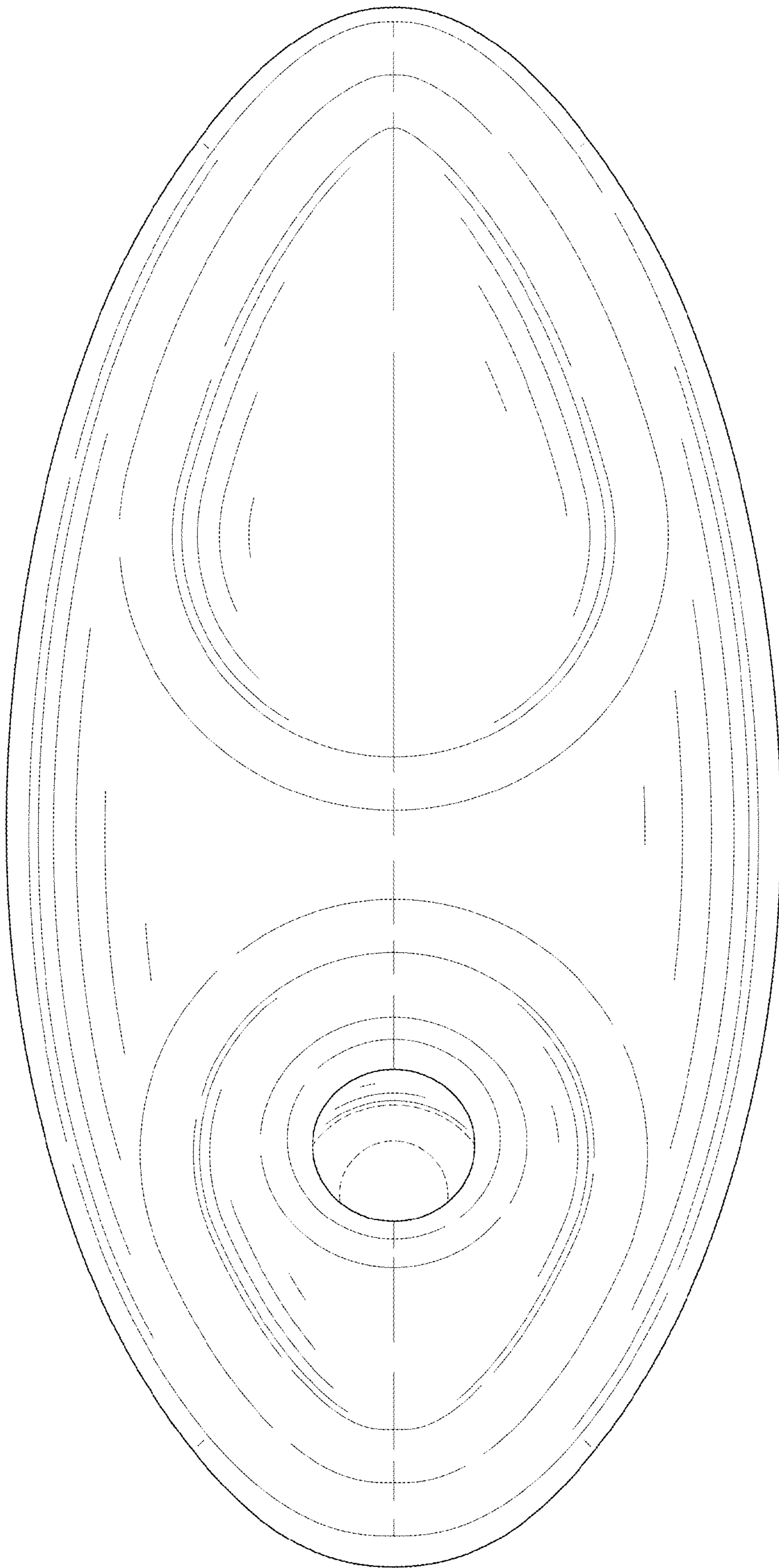

FIG. 7



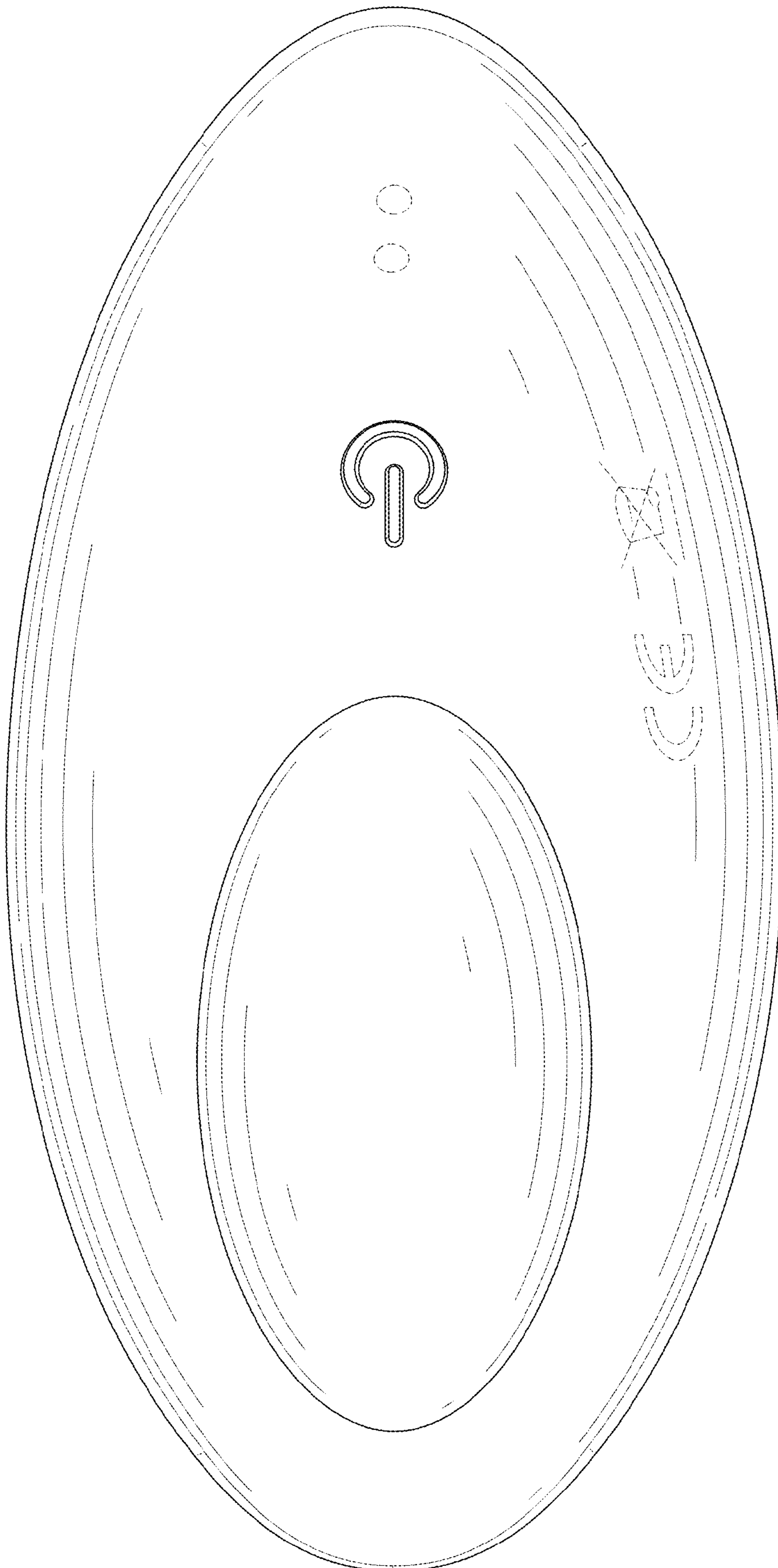

FIG. 8