



US00D974531S

(12) **United States Design Patent** (10) **Patent No.:** **US D974,531 S**  
**Ye** (45) **Date of Patent:** **\*\* Jan. 3, 2023**

(54) **SHOWER HEAD**  
(71) Applicant: **Saihua Ye**, Zhejiang Province (CN)  
(72) Inventor: **Saihua Ye**, Zhejiang Province (CN)  
(\*\*) Term: **15 Years**  
(21) Appl. No.: **29/773,693**

(22) Filed: **Mar. 11, 2021**

(30) **Foreign Application Priority Data**

Sep. 18, 2020 (CN) ..... 202030556948.1

(51) **LOC (14) Cl.** ..... **23-01**

(52) **U.S. Cl.**  
USPC ..... **D23/239**

(58) **Field of Classification Search**  
USPC ..... D23/238-244, 252, 254-255, 257, 499;  
D7/398  
CPC .... F16K 31/602; F16K 31/605; F16K 31/607;  
E03C 1/0412  
See application file for complete search history.

(56) **References Cited**

**U.S. PATENT DOCUMENTS**

D228,622 S \* 10/1973 Jublin ..... D8/373  
D341,191 S \* 11/1993 Klose ..... D6/524  
D419,227 S \* 1/2000 Ben-Tsur ..... D23/304  
D512,125 S \* 11/2005 Kulig ..... D23/238  
D565,711 S \* 4/2008 Giggs ..... D23/304  
D587,357 S \* 2/2009 Hoernig ..... D23/304  
D667,084 S \* 9/2012 Berger ..... D23/238  
D695,880 S \* 12/2013 Schoenherr ..... D23/304  
D832,412 S \* 10/2018 Nikles ..... D23/304

D912,779 S \* 3/2021 Tanghetti ..... E03C 1/04  
D23/238  
D925,017 S \* 7/2021 Liu ..... D23/304  
2020/0291626 A1 \* 9/2020 Wu ..... E03C 1/0408

**FOREIGN PATENT DOCUMENTS**

CN 304784456 \* 8/2018

**OTHER PUBLICATIONS**

Delta Faucet U4985-BL-PK UniversalShoweringComponents, first available Mar. 1, 2017[online], [site visited Aug. 8, 2022]. Available from internet, URL:<<https://www.amazon.com/Delta-Faucet-U4985-BL-PK-UniversalShoweringComponents-Adjustable/dp/B06XCPBS1H>> (Year: 2017).\*

\* cited by examiner

*Primary Examiner* — David G Muller  
*Assistant Examiner* — Jamaal Rasheed

(57) **CLAIM**

The ornamental design for a shower head, as shown and described.

**DESCRIPTION**

FIG. 1 is a perspective view of a shower head showing my new design;  
FIG. 2 is a front elevational view thereof;  
FIG. 3 is a top plan view thereof;  
FIG. 4 is a left side elevational view thereof;  
FIG. 5 is a rear elevational view thereof;  
FIG. 6 is a right side view thereof; and,  
FIG. 7 is a bottom plan view thereof.  
The broken lines illustrate portions of the shower head that form no part of the claimed design.

**1 Claim, 7 Drawing Sheets**

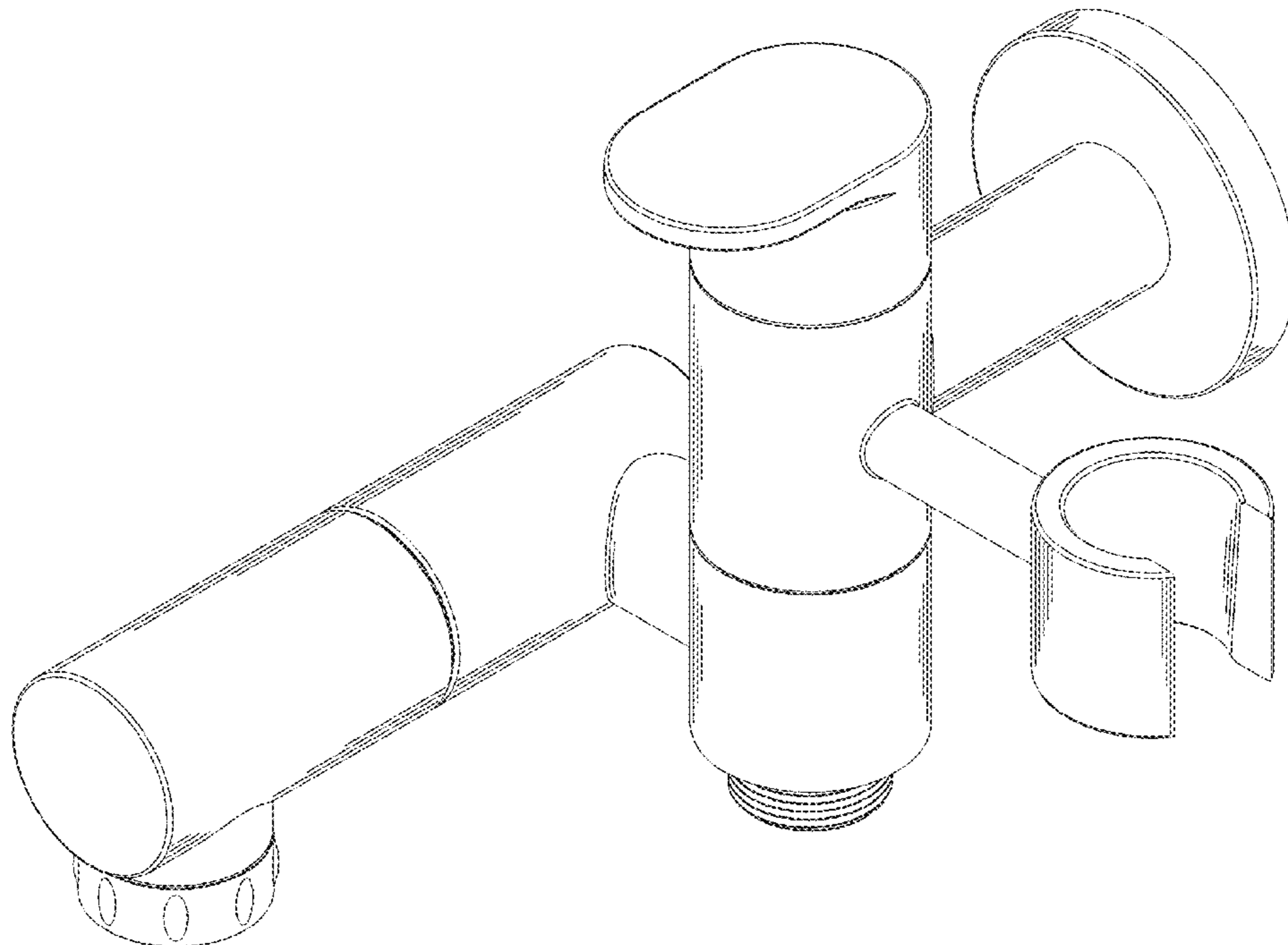

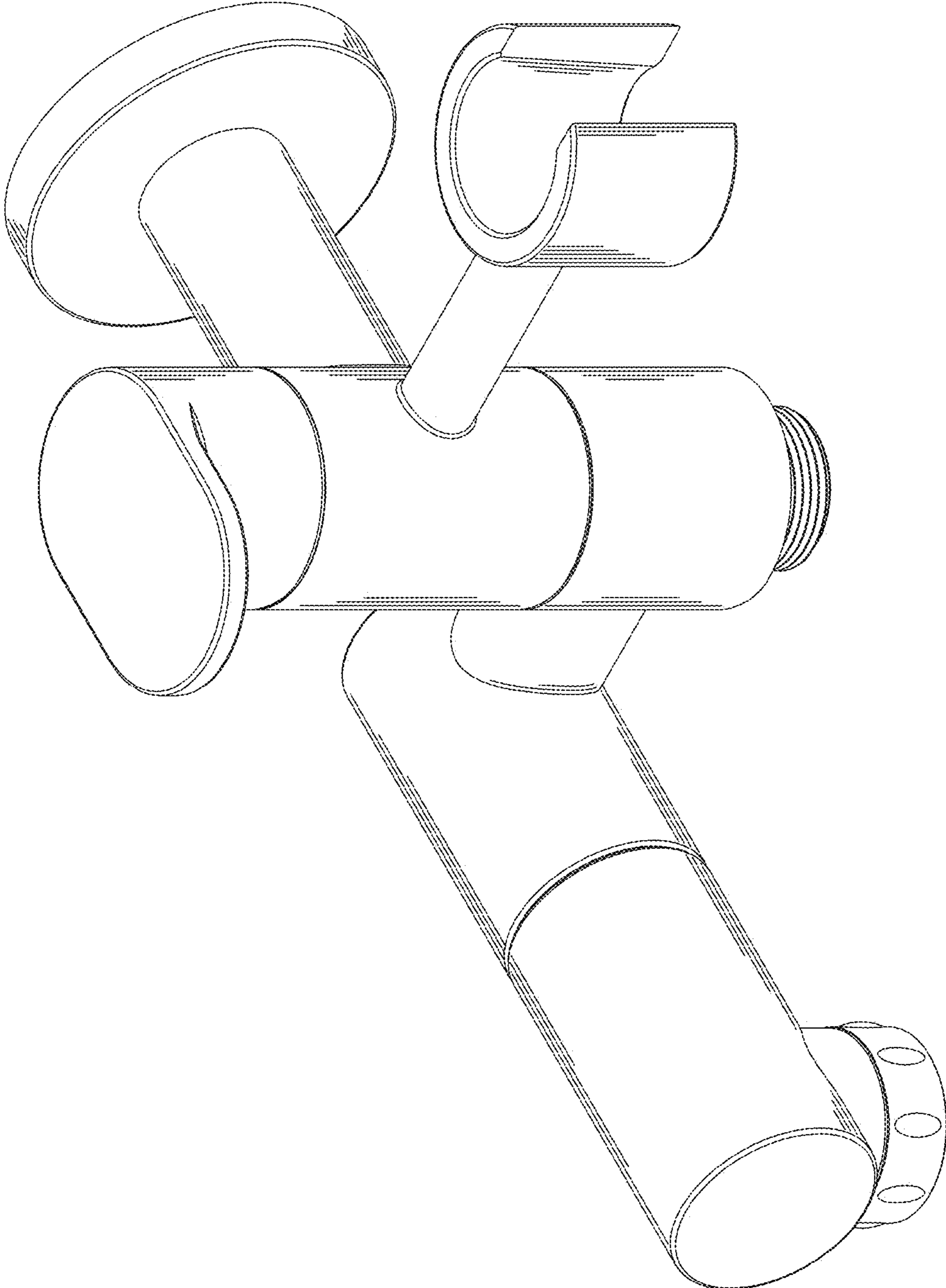

FIG. 1

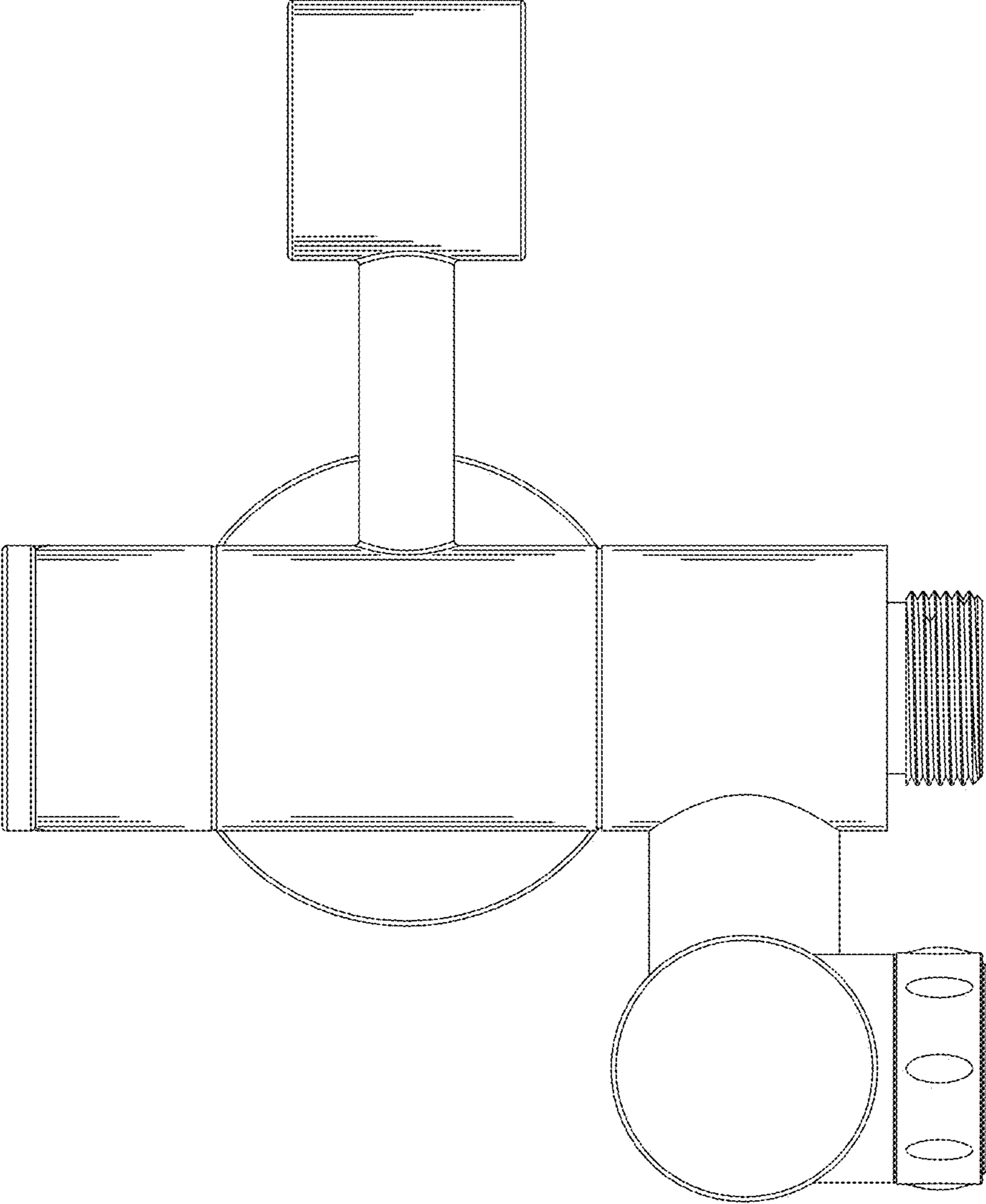

FIG. 2

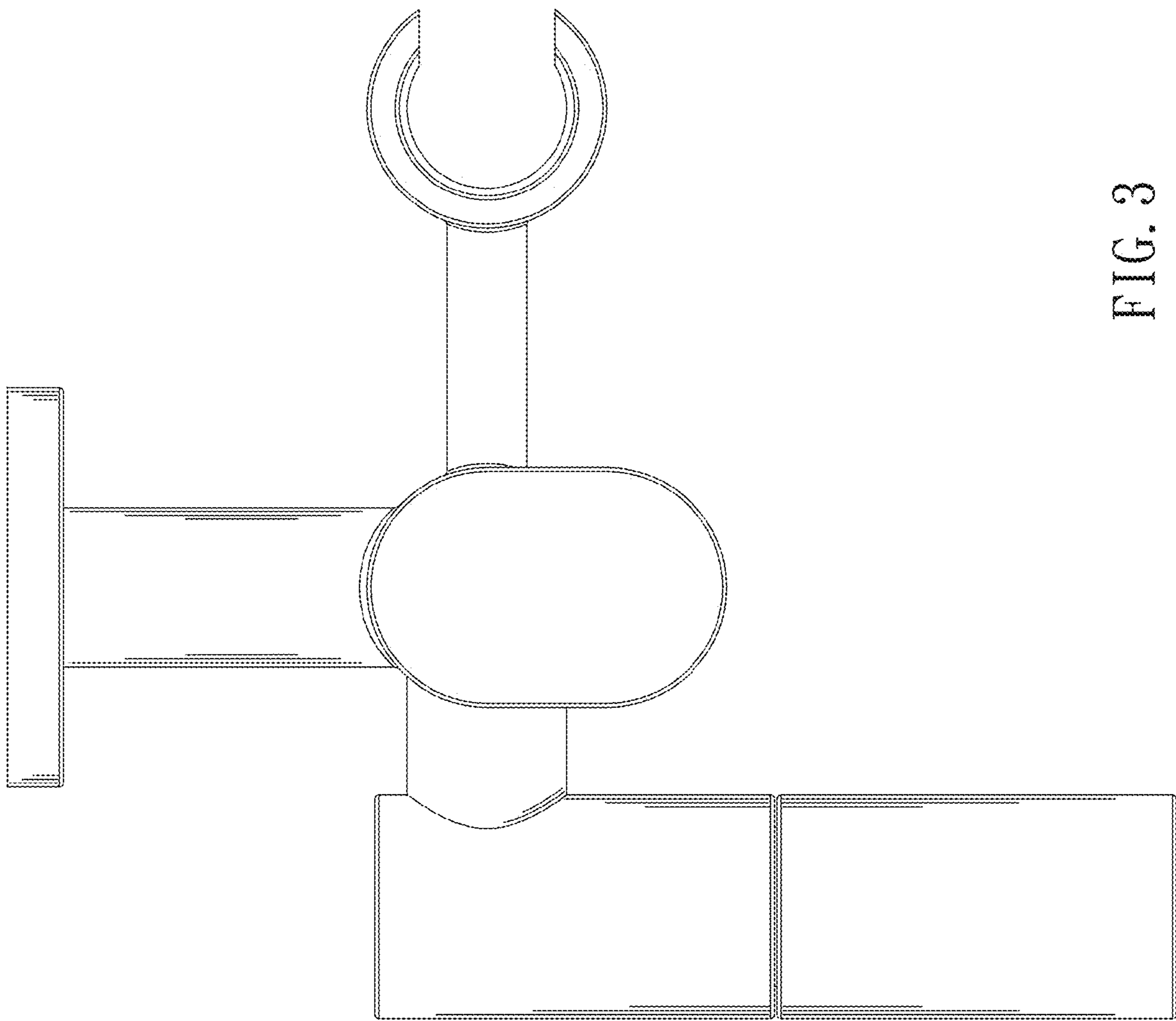

FIG. 3

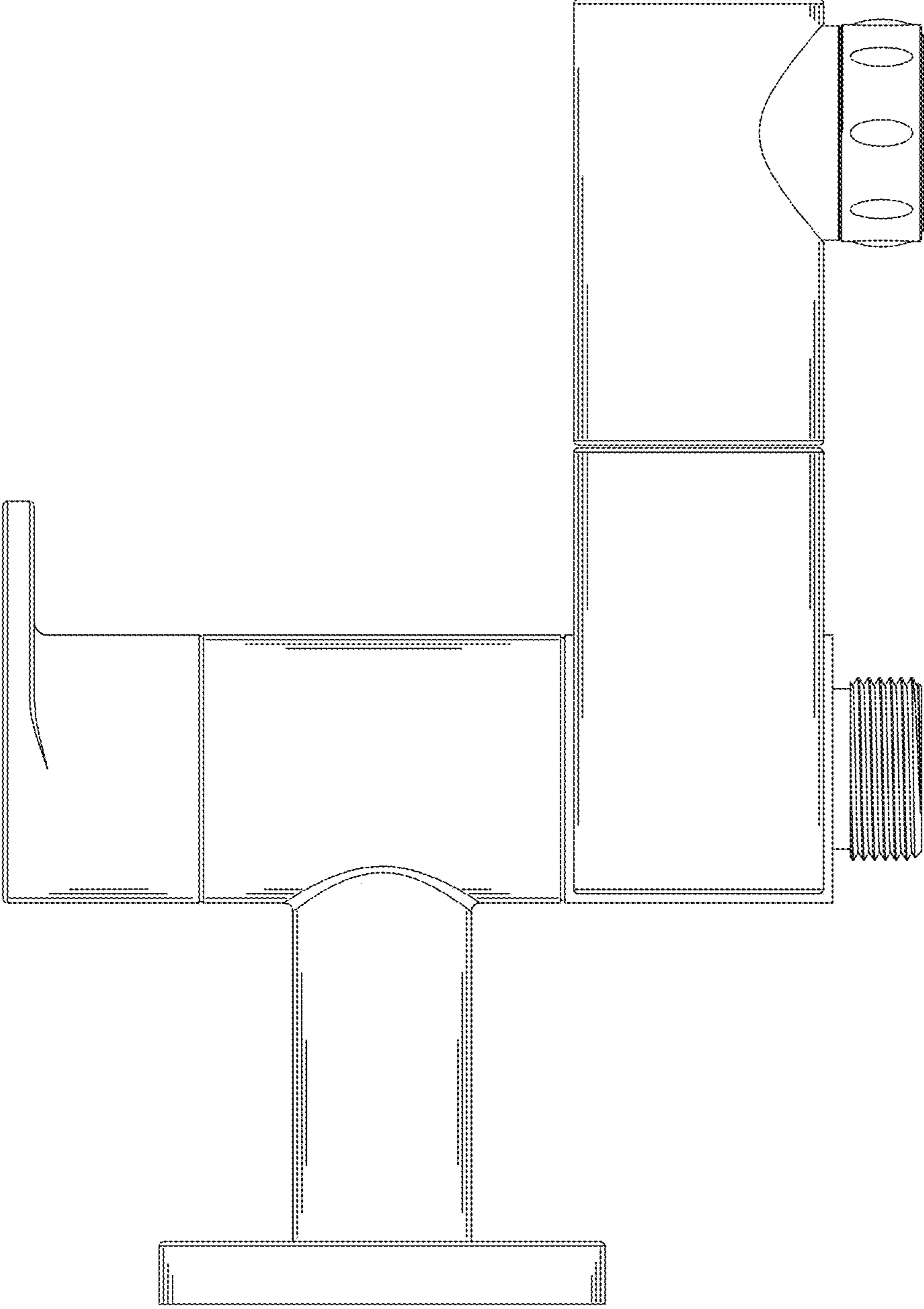

FIG. 4

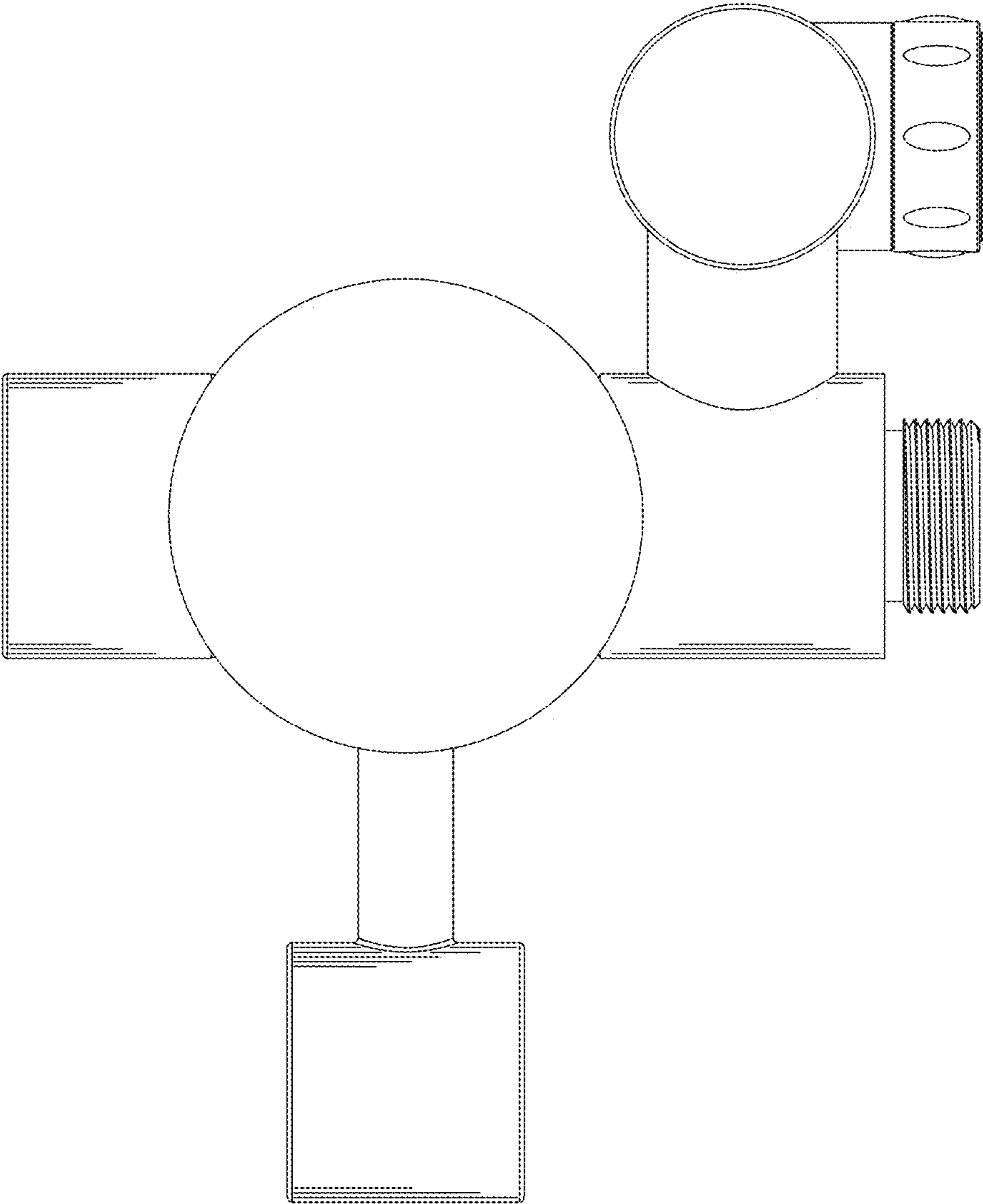

FIG. 5

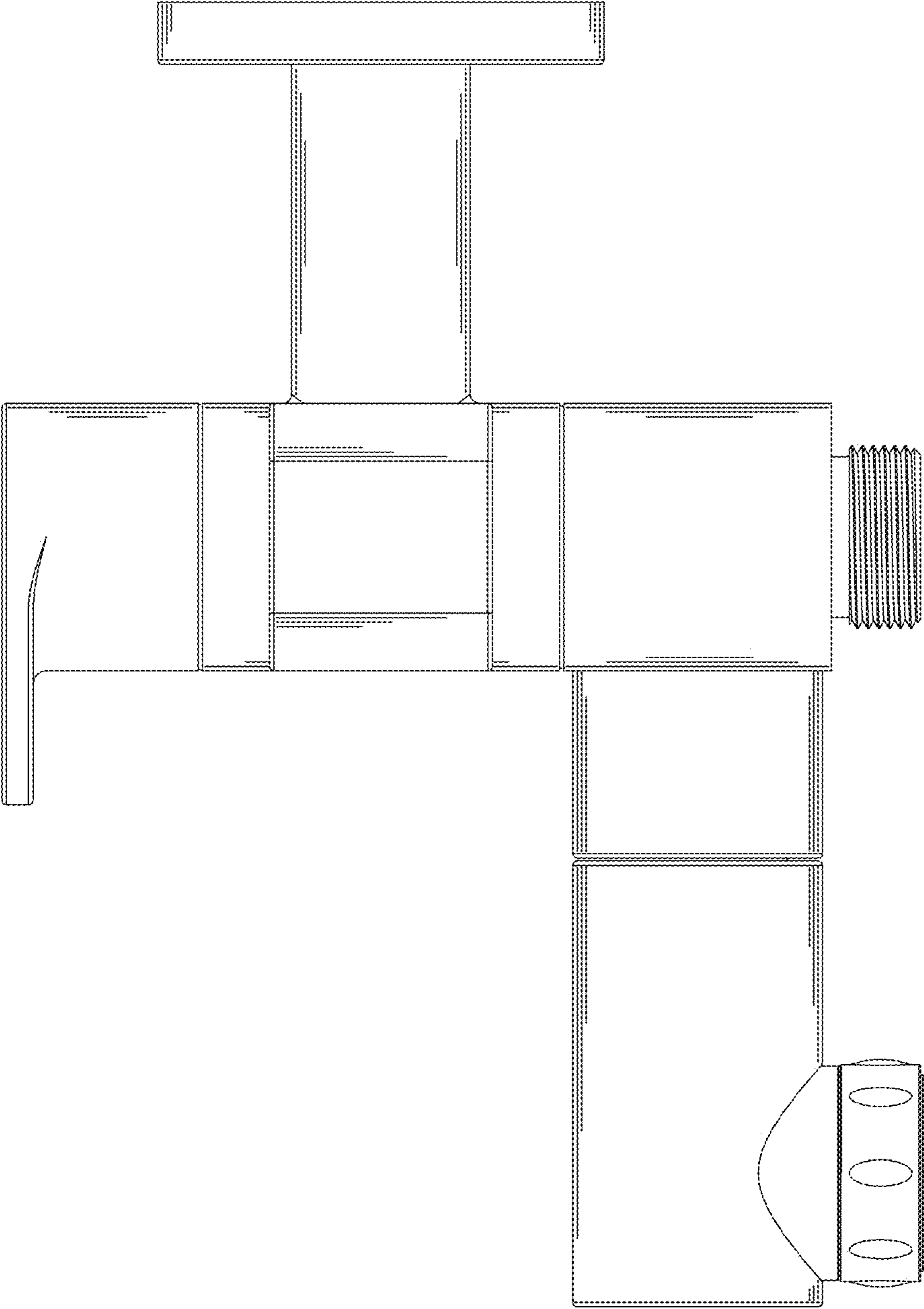

FIG. 6

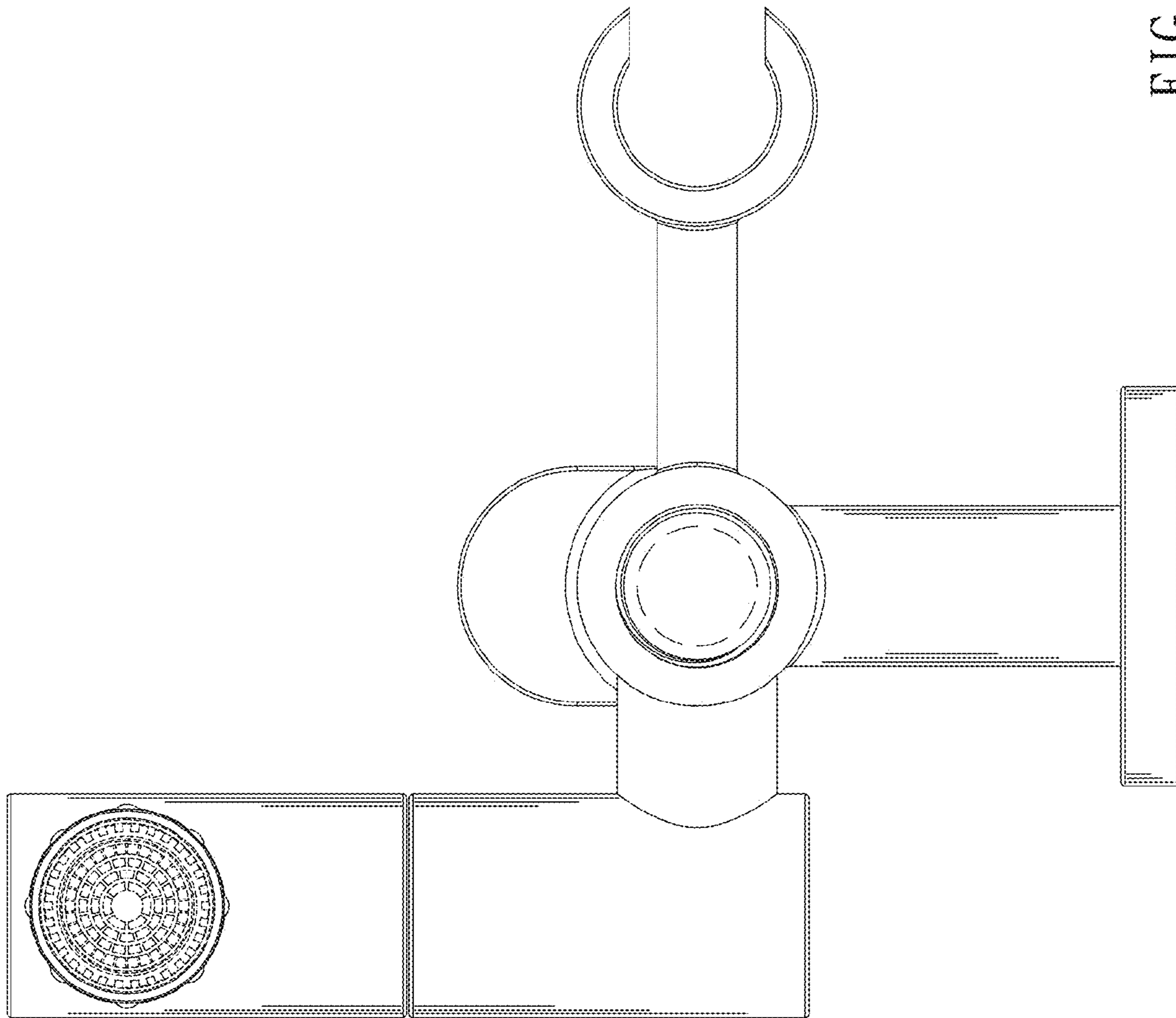

FIG. 7