



US00D974530S

(12) **United States Design Patent** (10) **Patent No.:** **US D974,530 S**
Ye (45) **Date of Patent:** **** Jan. 3, 2023**

(54) **SHOWER HEAD**
(71) Applicant: **Saihua Ye**, Zhejiang Province (CN)
(72) Inventor: **Saihua Ye**, Zhejiang Province (CN)
(**) Term: **15 Years**
(21) Appl. No.: **29/773,691**

D912,779 S * 3/2021 Tanghetti E03C 1/04
D23/238
D925,017 S * 7/2021 Liu D23/304
2020/0291626 A1* 9/2020 Wu E03C 1/0408

FOREIGN PATENT DOCUMENTS

CN 304784456 * 8/2018

OTHER PUBLICATIONS

Delta Faucet U4985-BL-PK UniversalShoweringComponents, first available Mar. 1, 2017[online], [site visited Aug. 8, 2022]. Available from internet, URL:<<https://www.amazon.com/Delta-Faucet-U4985-BL-PK-UniversalShoweringComponents-Adjustable/dp/B06XCPBS1H>> (Year: 2017).*

* cited by examiner

Primary Examiner — David G Muller
Assistant Examiner — Jamaal Rasheed

(57) **CLAIM**

The ornamental design for a shower head, as shown and described.

DESCRIPTION

FIG. 1 is a perspective view of a shower head showing my new design;
FIG. 2 is a front elevational view thereof;
FIG. 3 is a top plan view thereof;
FIG. 4 is a left side elevational view thereof;
FIG. 5 is a rear elevational view thereof;
FIG. 6 is a right side view thereof; and,
FIG. 7 is a bottom plan view thereof.
The broken lines illustrate portions of the shower head that form no part of the claimed design.

1 Claim, 7 Drawing Sheets

(30) **Foreign Application Priority Data**

Sep. 18, 2020 (CN) 202030556976.3

(51) **LOC (14) Cl.** **23-01**

(52) **U.S. Cl.**
USPC **D23/239**

(58) **Field of Classification Search**
USPC D23/238-244, 252, 254-255, 257, 499;
D7/398
CPC F16K 31/602; F16K 31/605; F16K 31/607;
E03C 1/0412

See application file for complete search history.

(56) **References Cited**

U.S. PATENT DOCUMENTS

D228,622 S * 10/1973 Jublin D8/373
D341,191 S * 11/1993 Klose D6/524
D419,227 S * 1/2000 Ben-Tsur D23/304
D512,125 S * 11/2005 Kulig D23/238
D565,711 S * 4/2008 Giggs D23/304
D587,357 S * 2/2009 Hoernig D23/304
D667,084 S * 9/2012 Berger D23/238
D695,880 S * 12/2013 Schoenherr D23/304
D832,412 S * 10/2018 Nikles D23/304

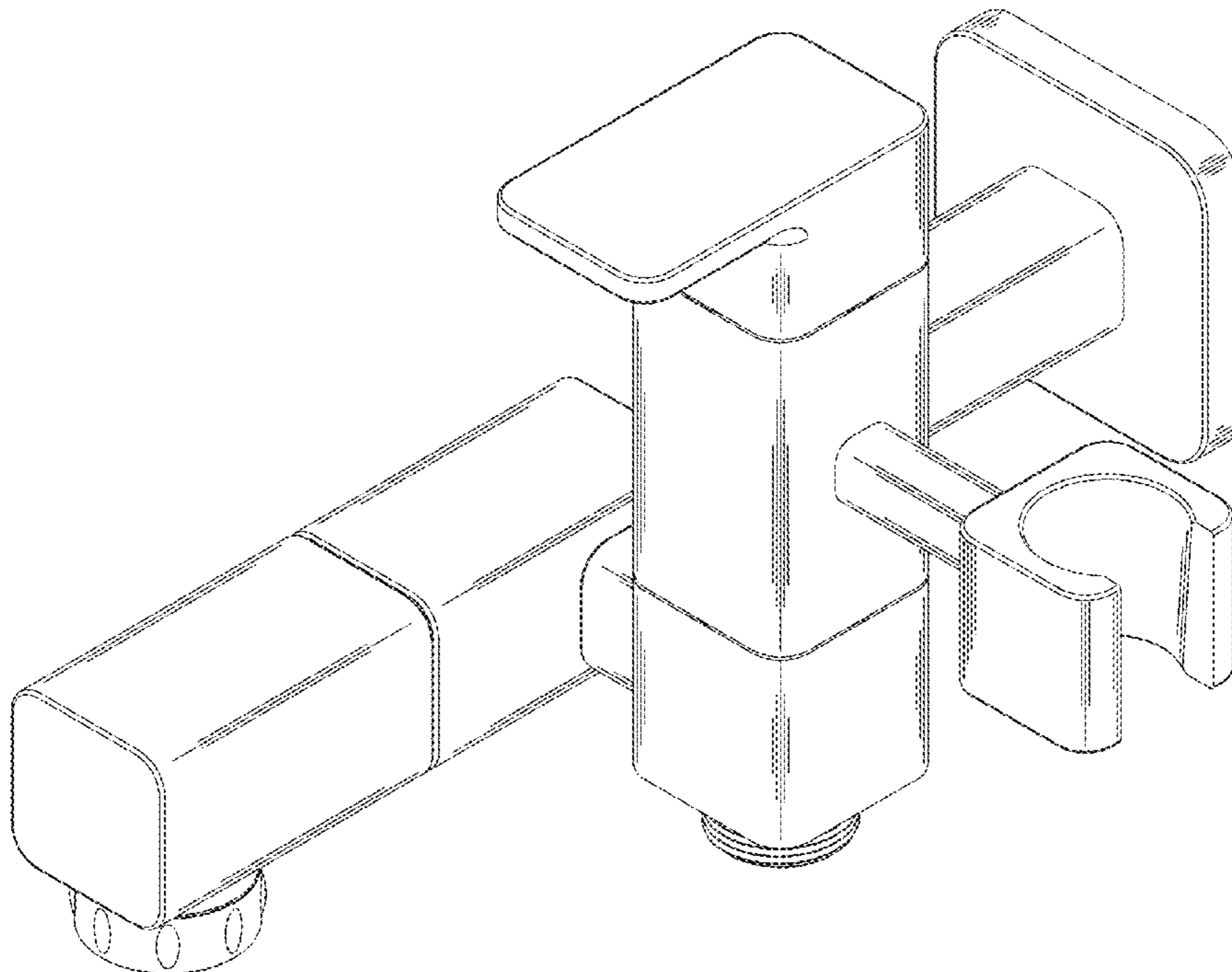

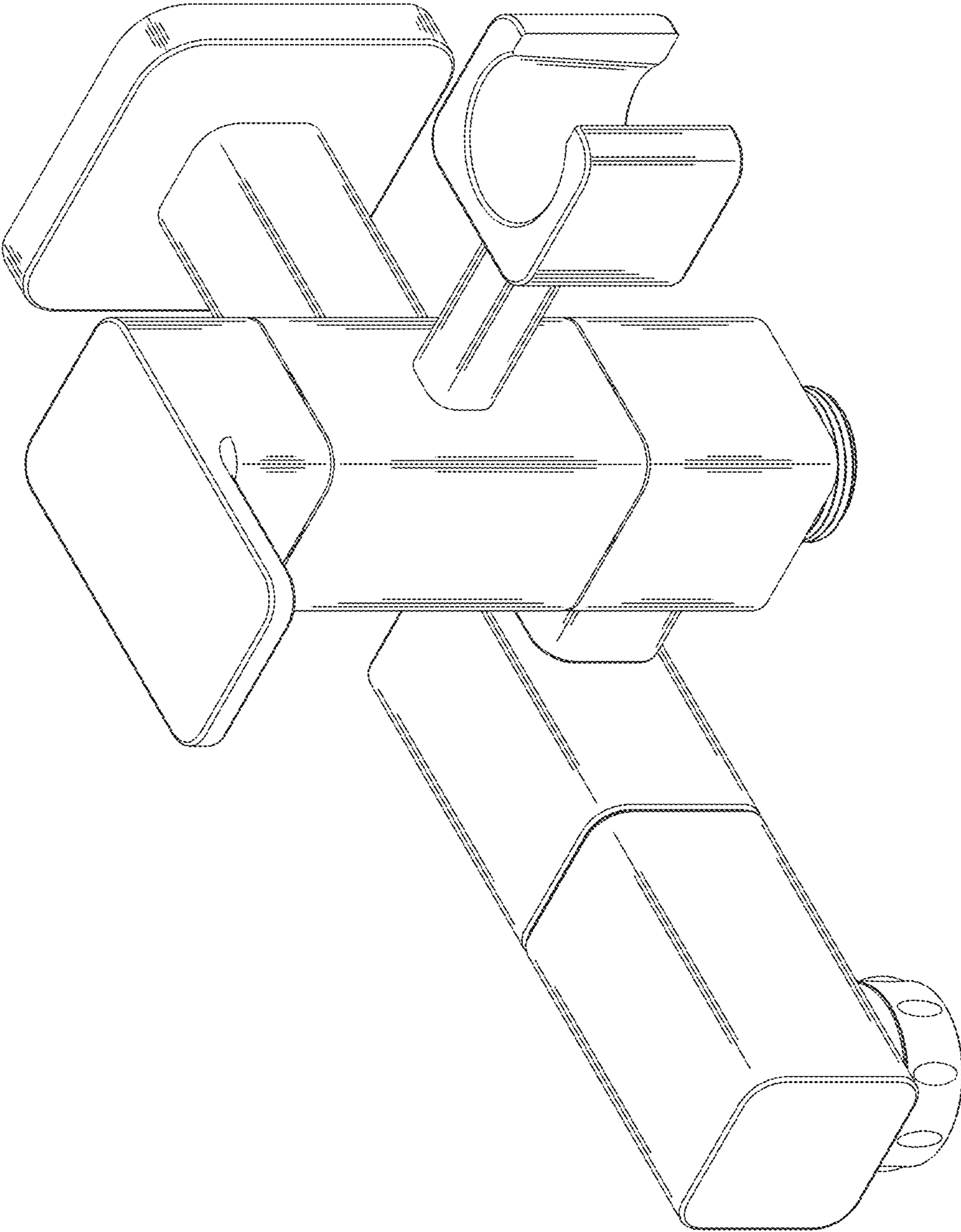

FIG. 1

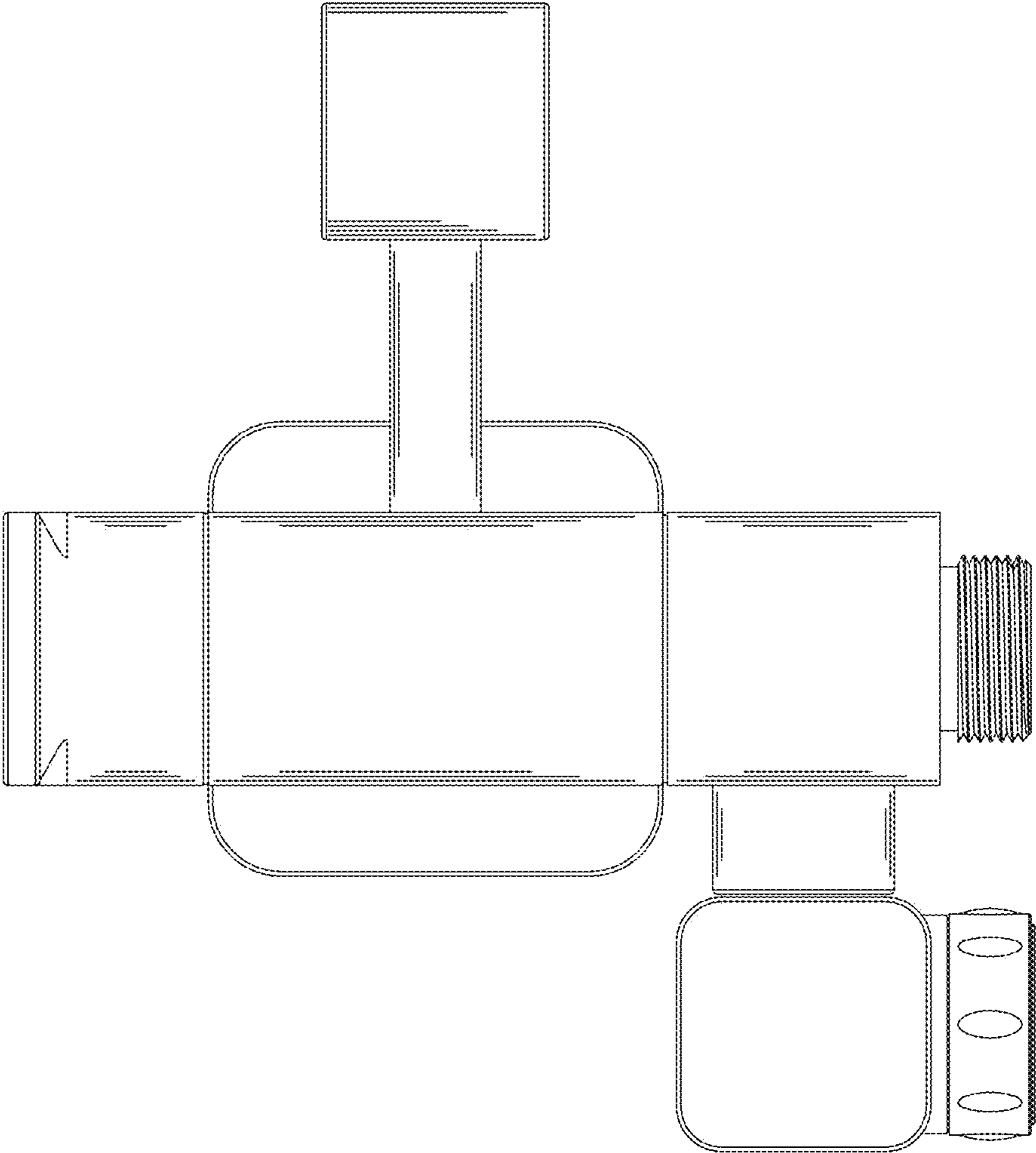

FIG. 2

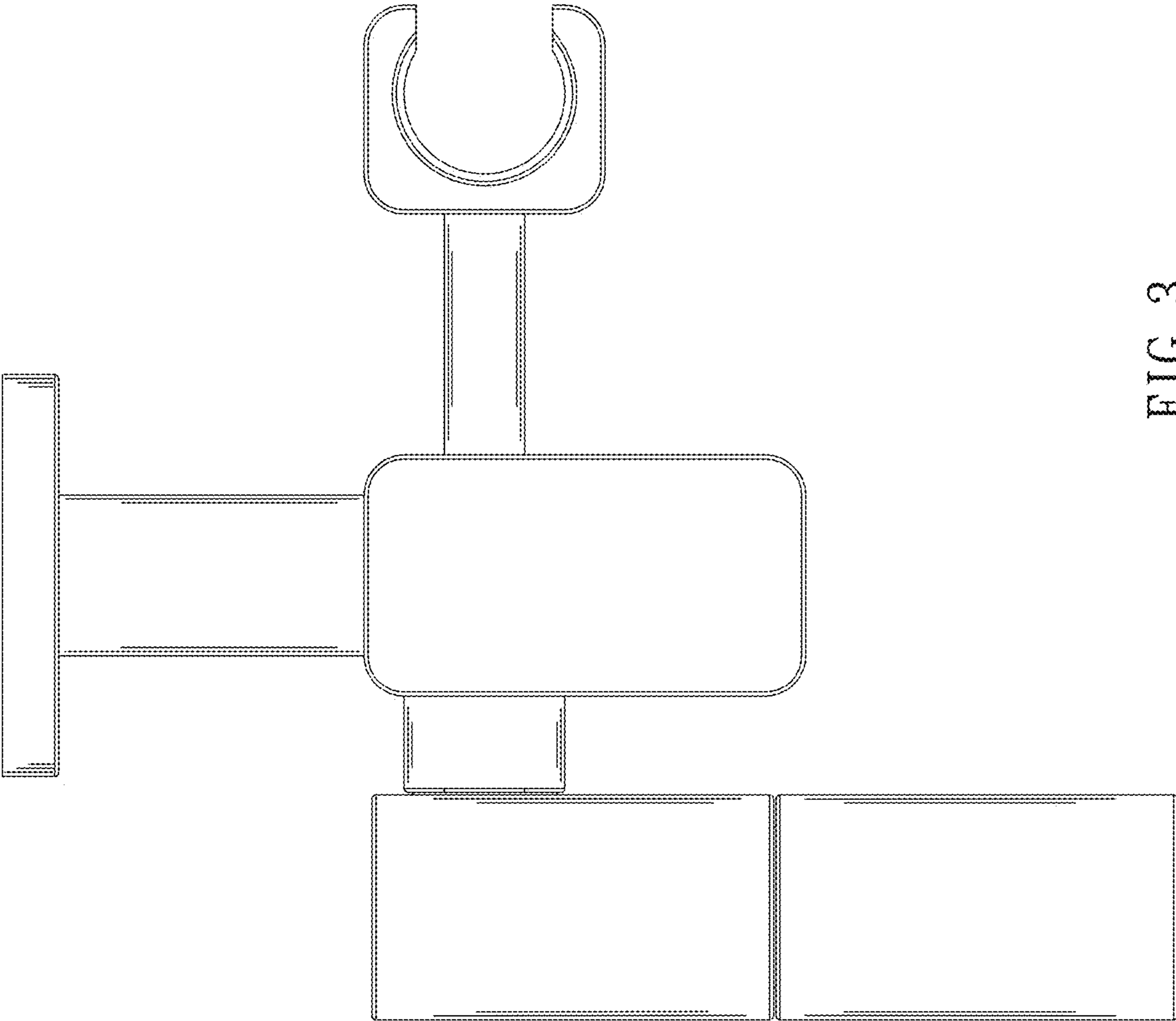

FIG. 3

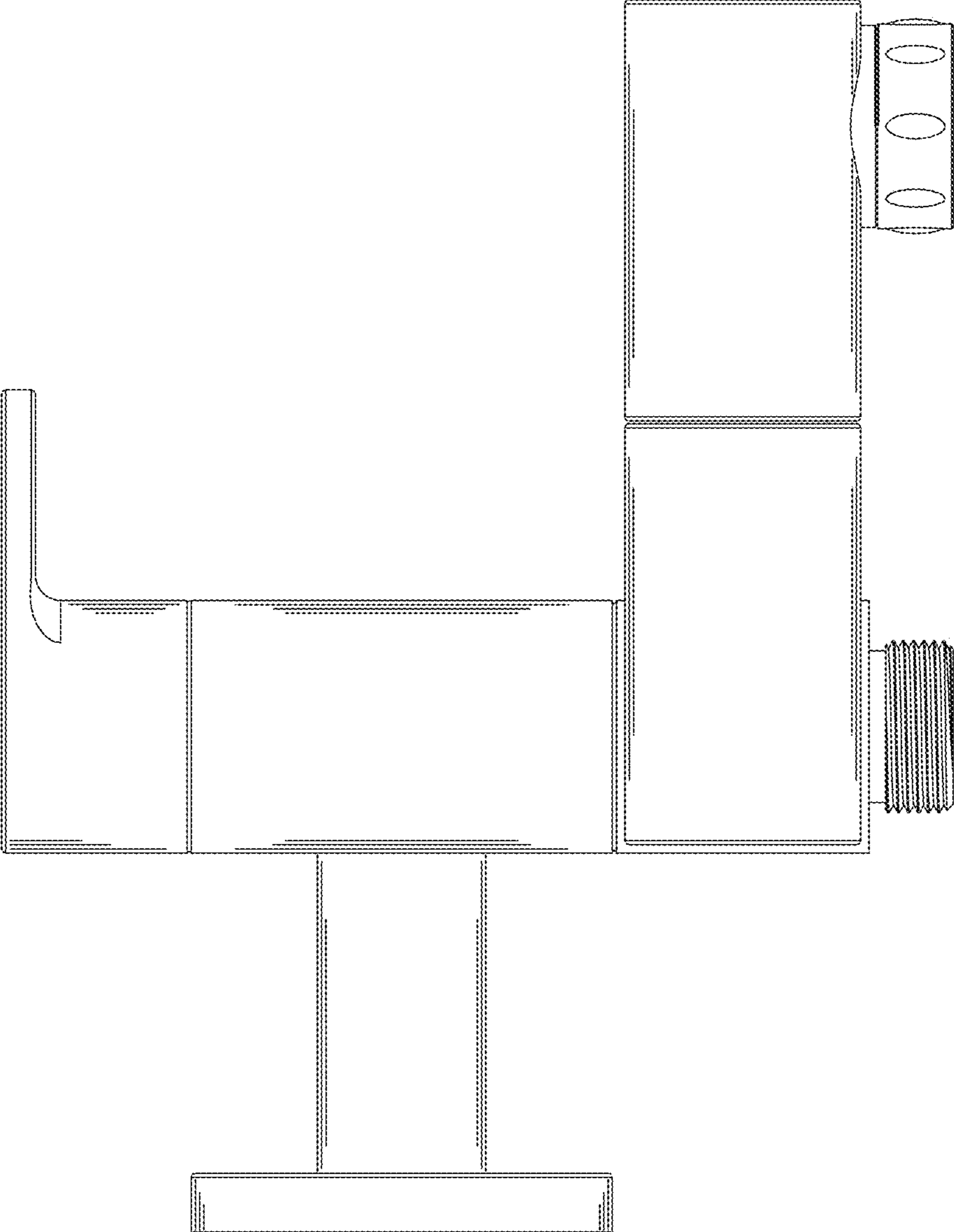

FIG. 4

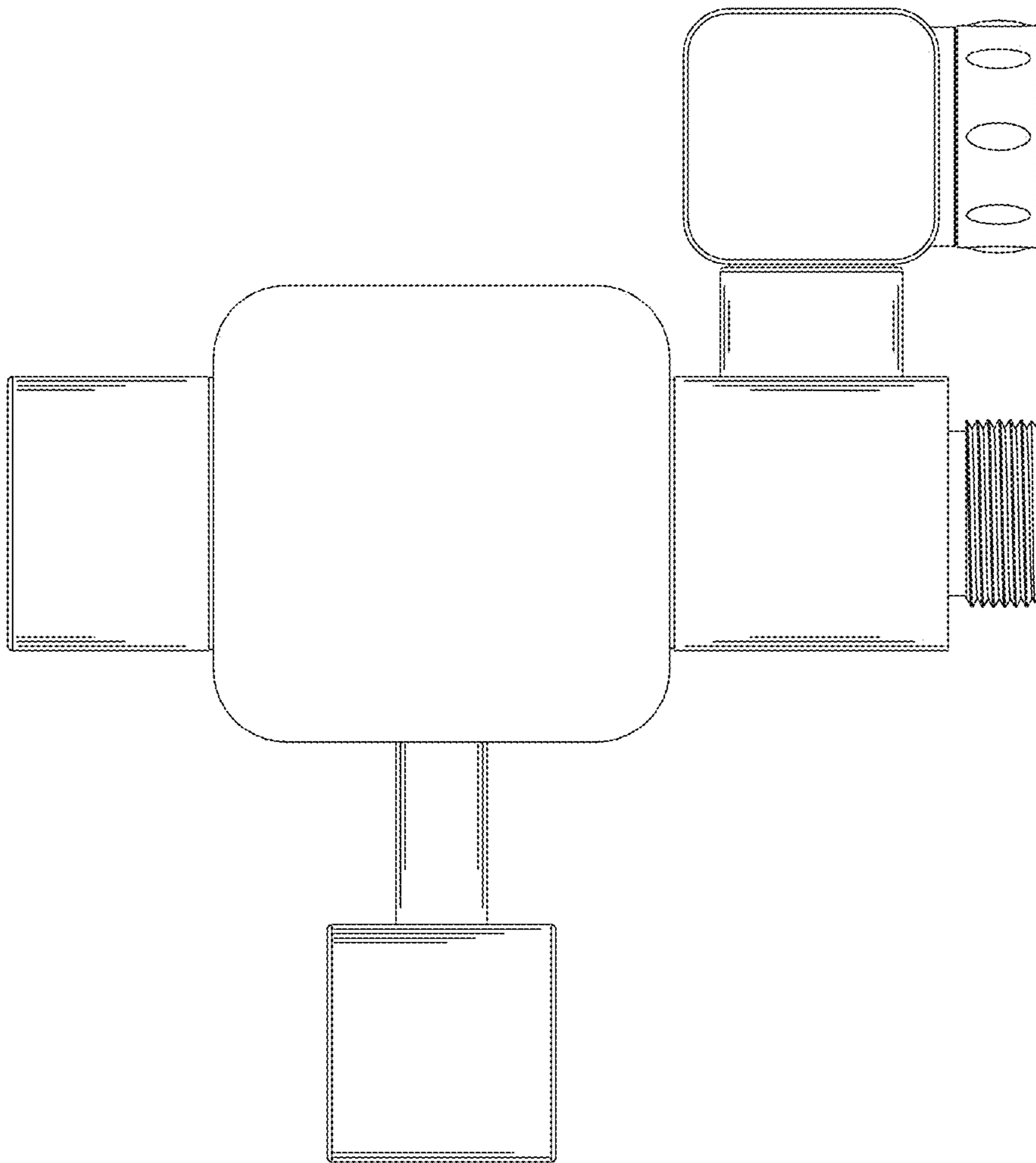

FIG. 5

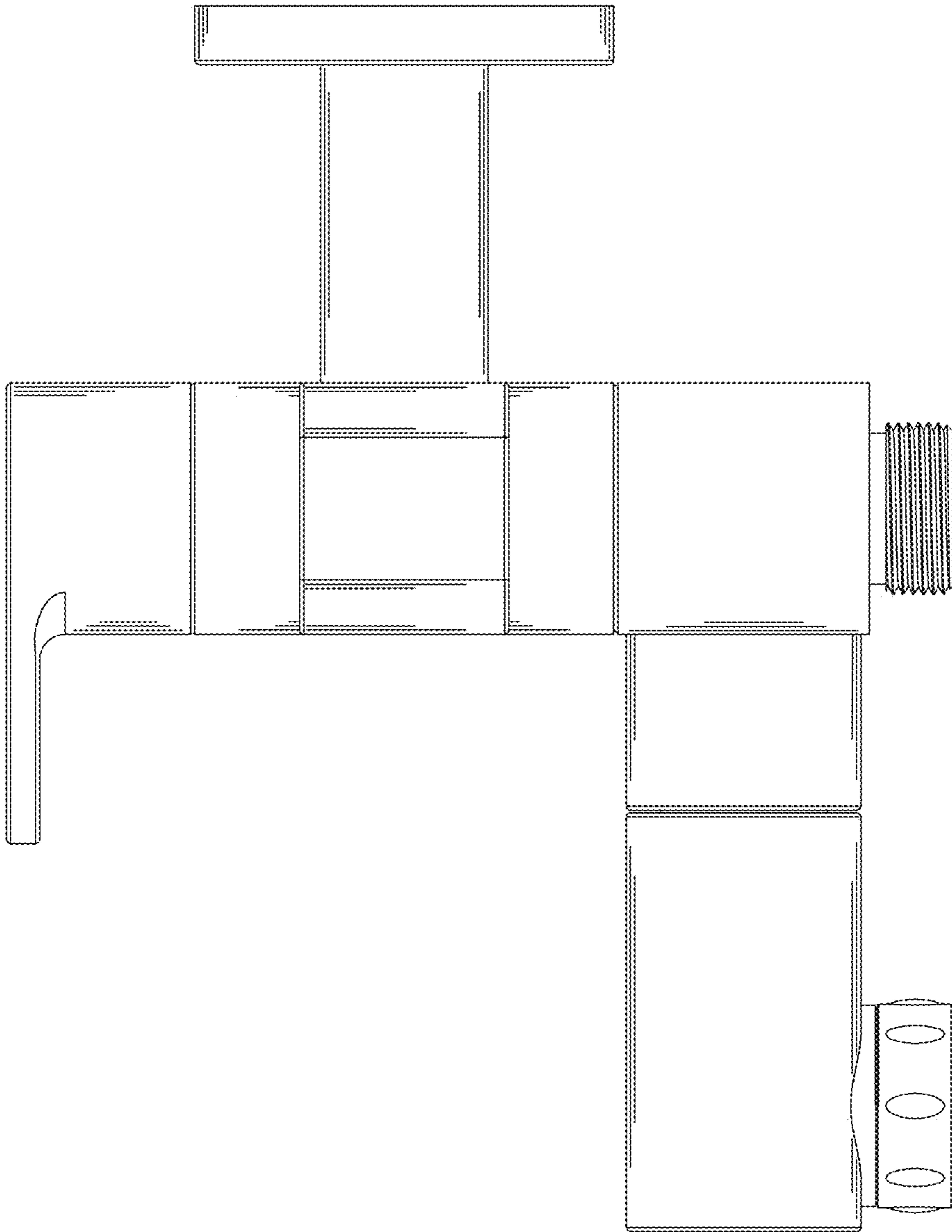

FIG. 6

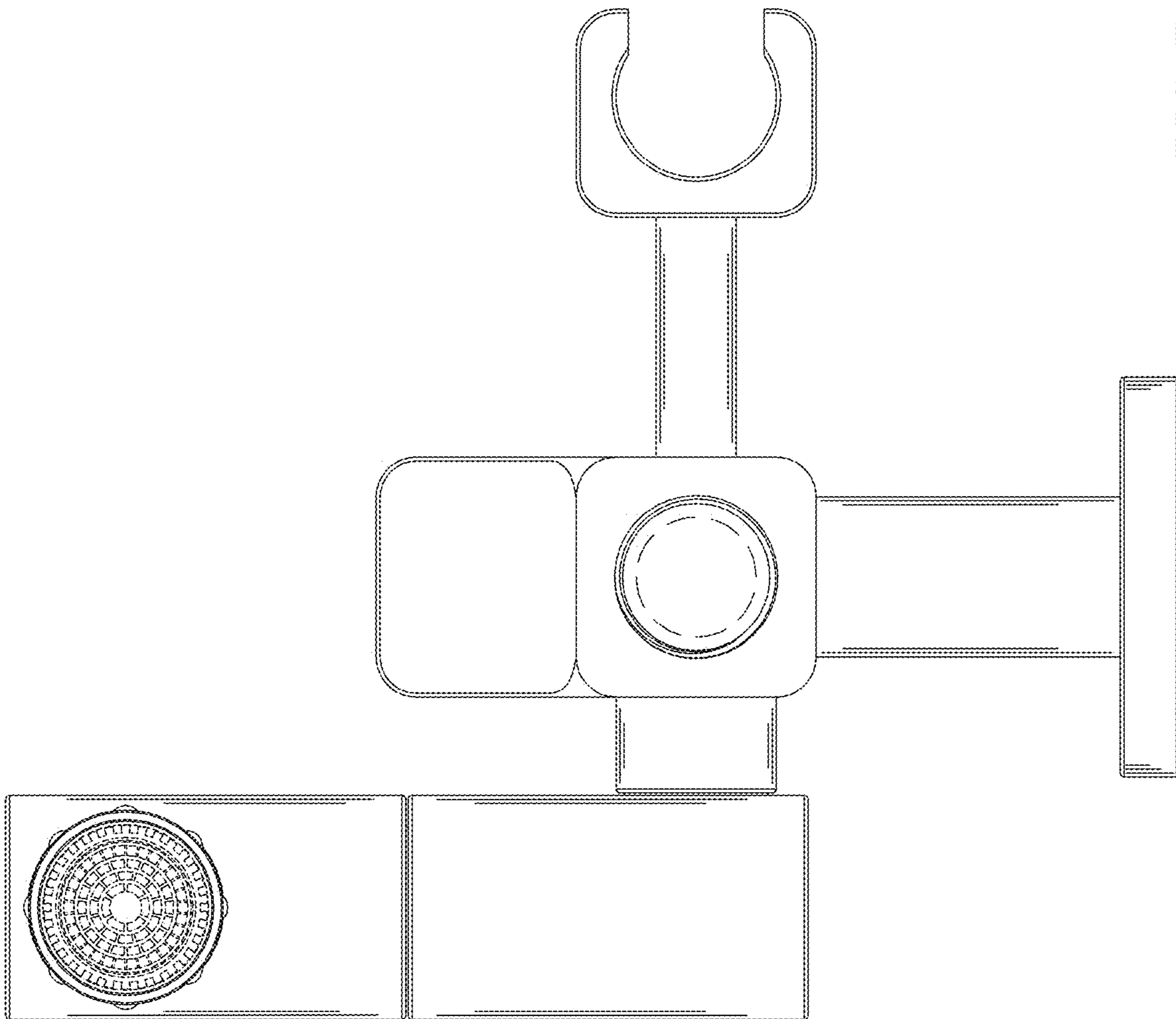

FIG. 7