



US00D974365S

(12) **United States Design Patent**  
**Fisher et al.**

(10) **Patent No.:** **US D974,365 S**  
(45) **Date of Patent:** **\*\* Jan. 3, 2023**

(54) **INSTRUMENT PANEL**

(71) Applicant: **Baker Hughes Oilfield Operations LLC**, Houston, TX (US)

(72) Inventors: **Steven William Fisher**, Edmonds, WA (US); **Kevin Doan**, Seattle, WA (US); **Malgorzata Anna Blachnicka**, Seattle, WA (US); **Bryan Shadel**, Gardnerville, NV (US)

(73) Assignee: **Baker Hughes Oilfield Operations LLC**, Houston, TX (US)

(\*\*) Term: **15 Years**

(21) Appl. No.: **29/705,076**

(22) Filed: **Sep. 9, 2019**

(51) **LOC (14) Cl.** ..... **14-02**

(52) **U.S. Cl.**  
USPC ..... **D14/443**; D14/313; D14/445

(58) **Field of Classification Search**  
USPC ..... D14/300, 301, 308, 310, 311, 312, 313, D14/314, 348, 353, 354, 355, 356, 357,  
(Continued)

(56) **References Cited**

**U.S. PATENT DOCUMENTS**

D231,464 S \* 4/1974 Dalke ..... D14/313  
D304,823 S \* 11/1989 Pfeifer ..... D14/353  
(Continued)

**OTHER PUBLICATIONS**

AMS 6500 ATG Protection System with Embedded Prediction Capabilities. Emerson. (Online) Posted Mar. 5, 2019. [Retrieved Nov. 16, 2021]. <https://www.customcontrols.co.nz/2019/03/05/ams-6500-atg-protection-system-with-embedded-prediction-capabilities/> (Year: 2019).\*

(Continued)

*Primary Examiner* — Kathleen L Jones  
*Assistant Examiner* — Cole Sanders Holman

(74) *Attorney, Agent, or Firm* — Mintz Levin Cohn Ferris Glovsky and Popeo, P.C.

(57) **CLAIM**

The ornamental design for an instrument panel, as shown and described.

**DESCRIPTION**

FIG. 1 is a front-facing perspective view of an instrument panel showing a first embodiment of our design; FIG. 2 is a rear-facing perspective view of the instrument panel of FIG. 1; FIG. 3 is a rear-facing, exploded perspective view of the instrument panel of FIG. 1; FIG. 4 is a front view of the instrument panel of FIG. 1; FIG. 5 is a top view of the card module of FIG. 1; FIG. 6 is a bottom view of the card module of FIG. 1; FIG. 7 is a left view of the card module of FIG. 1; FIG. 8 is a right view of the card module of FIG. 1; FIG. 9 is a front-facing perspective view of another instrument panel showing a second embodiment of our design; FIG. 10 is a rear-facing perspective view of the instrument panel of FIG. 9; FIG. 11 is a rear-facing, exploded perspective view of the instrument panel of FIG. 9; FIG. 12 is a front view of the instrument panel of FIG. 9; FIG. 13 is a top view of the card module of FIG. 9; FIG. 14 is a bottom view of the card module of FIG. 9; FIG. 15 is a left view of the card module of FIG. 9; FIG. 16 is a right view of the card module of FIG. 9; FIG. 17 is a front-facing perspective view of another instrument panel showing a third embodiment of our design; FIG. 18 is a rear-facing perspective view of the instrument panel of FIG. 17; FIG. 19 is a rear-facing, exploded perspective view of the instrument panel of FIG. 17; FIG. 20 is a front view of the instrument panel of FIG. 17; FIG. 21 is a top view of the card module of FIG. 17; FIG. 22 is a bottom view of the card module of FIG. 17; FIG. 23 is a left view of the card module of FIG. 17; FIG. 24 is a right view of the card module of FIG. 17;

(Continued)

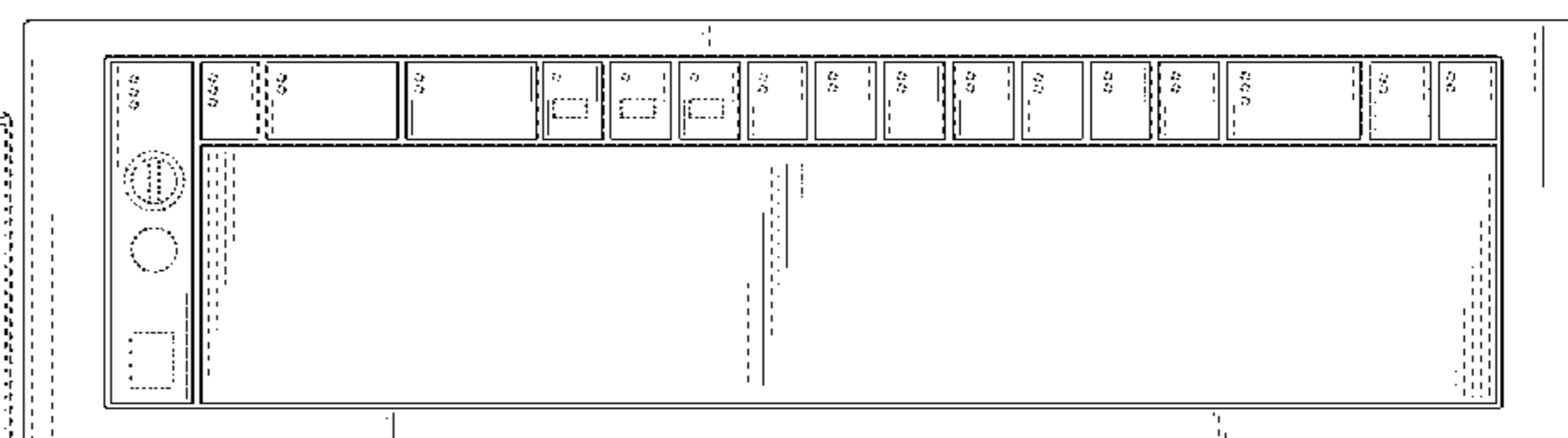
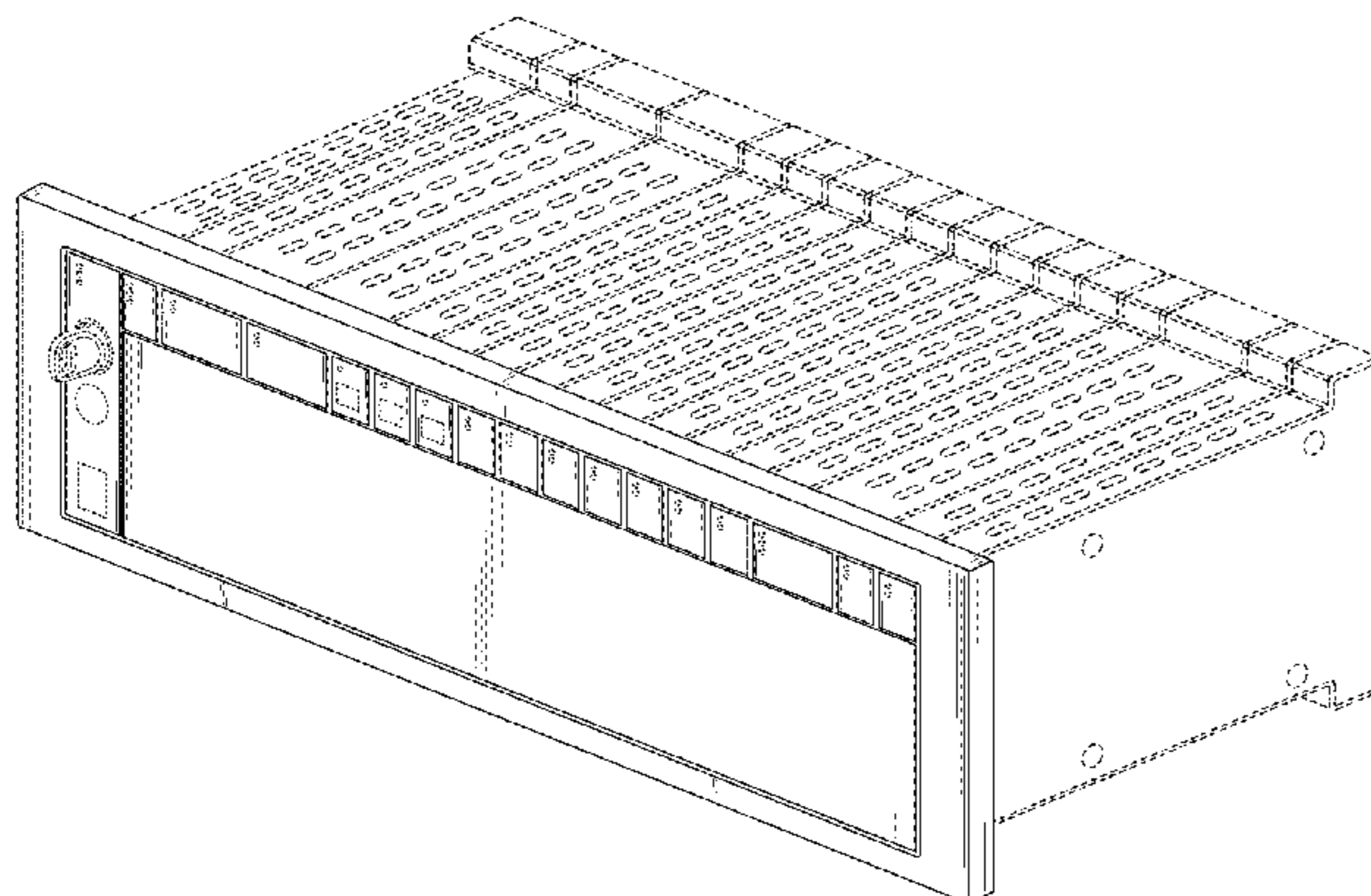

FIG. 25 is a front-facing perspective view of another instrument panel showing a fourth embodiment of our design; FIG. 26 is a rear-facing perspective view of the instrument panel of FIG. 25; FIG. 27 is a rear-facing, exploded perspective view of the instrument panel of FIG. 25; FIG. 28 is a front view of the instrument panel of FIG. 25; FIG. 29 is a top view of the card module of FIG. 25; FIG. 30 is a bottom view of the card module of FIG. 25; FIG. 31 is a left view of the card module of FIG. 25; and, FIG. 32 is a right view of the card module of FIG. 25. The broken lines showing an electronic device are included for the purpose of illustrating environmental structure and form no part of the claimed design.

**1 Claim, 32 Drawing Sheets**

(58) **Field of Classification Search**

USPC ..... D14/358, 388, 389, 432, 434, 439, 441, D14/443, 444, 445, 446, 257, 258, 188, D14/240; D13/184  
 CPC ..... G11B 15/6815; G11B 15/682; H05K 7/1465; H05K 7/1489; H05K 7/1424; H05K 7/1422; H05K 7/1481; H05K 5/003; H05K 5/004; H05K 5/006; H05K

5/0017; H05K 5/0021; H05K 5/0052; G05B 23/0213; G06F 1/187; G06F 1/147  
 See application file for complete search history.

(56)

**References Cited**

U.S. PATENT DOCUMENTS

D376,153	S	*	12/1996	Larson	.....	D14/257
D428,872	S	*	8/2000	Kizawa	.....	D14/188
D445,099	S	*	7/2001	Benders	.....	D14/135
D502,696	S	*	3/2005	Ishibashi	.....	D14/168
D589,041	S	*	3/2009	Teulie	.....	D14/188
D619,132	S	*	7/2010	Skaf	.....	D14/257
D644,640	S	*	9/2011	Warden	.....	D14/257
D663,305	S	*	7/2012	Green	.....	D14/441
D675,160	S	*	1/2013	Tanaka	.....	D13/123
D701,199	S	*	3/2014	Drew	.....	D14/301
D705,784	S	*	5/2014	Kuehn	.....	D14/441
D724,558	S	*	3/2015	Bast	.....	D14/188
D742,864	S	*	11/2015	Kurosawa	.....	D14/240
D754,096	S	*	4/2016	Teulie	.....	D14/188
D782,536	S	*	3/2017	Chu	.....	D14/496
D784,288	S	*	4/2017	Teulie	.....	D14/188
D890,134	S	*	7/2020	Zong	.....	D14/217
D913,296	S	*	3/2021	Pilliod	.....	D14/444

OTHER PUBLICATIONS

GTM 16—Gas Monitoring System. Taehttp://www.thmc.co.kr/gas3.htmlhung M&C Corporation. (Online) Date not available. [Retrieved Nov. 16, 2021]. (Year: 2021).\*

\* cited by examiner

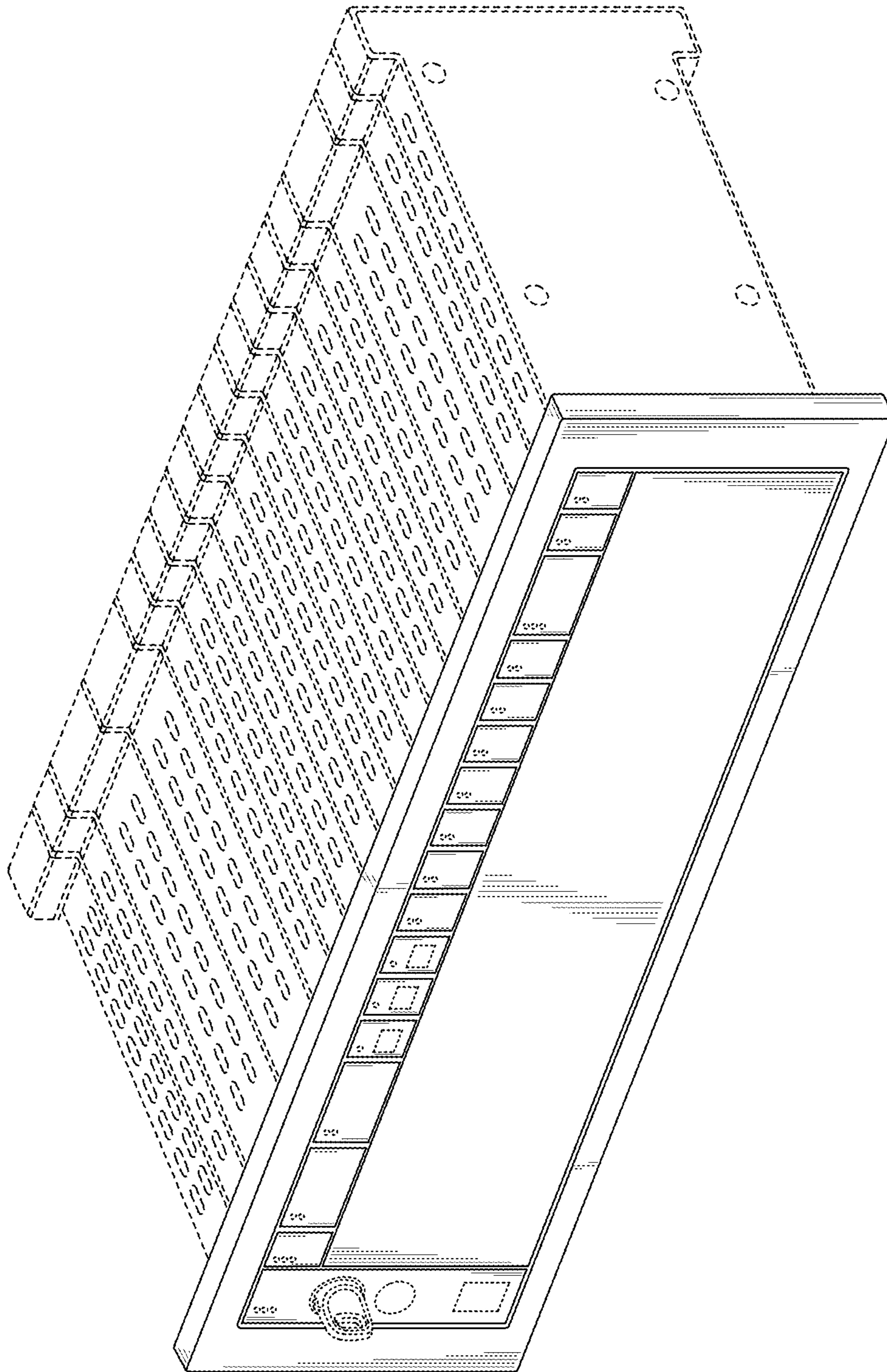

FIG. 1

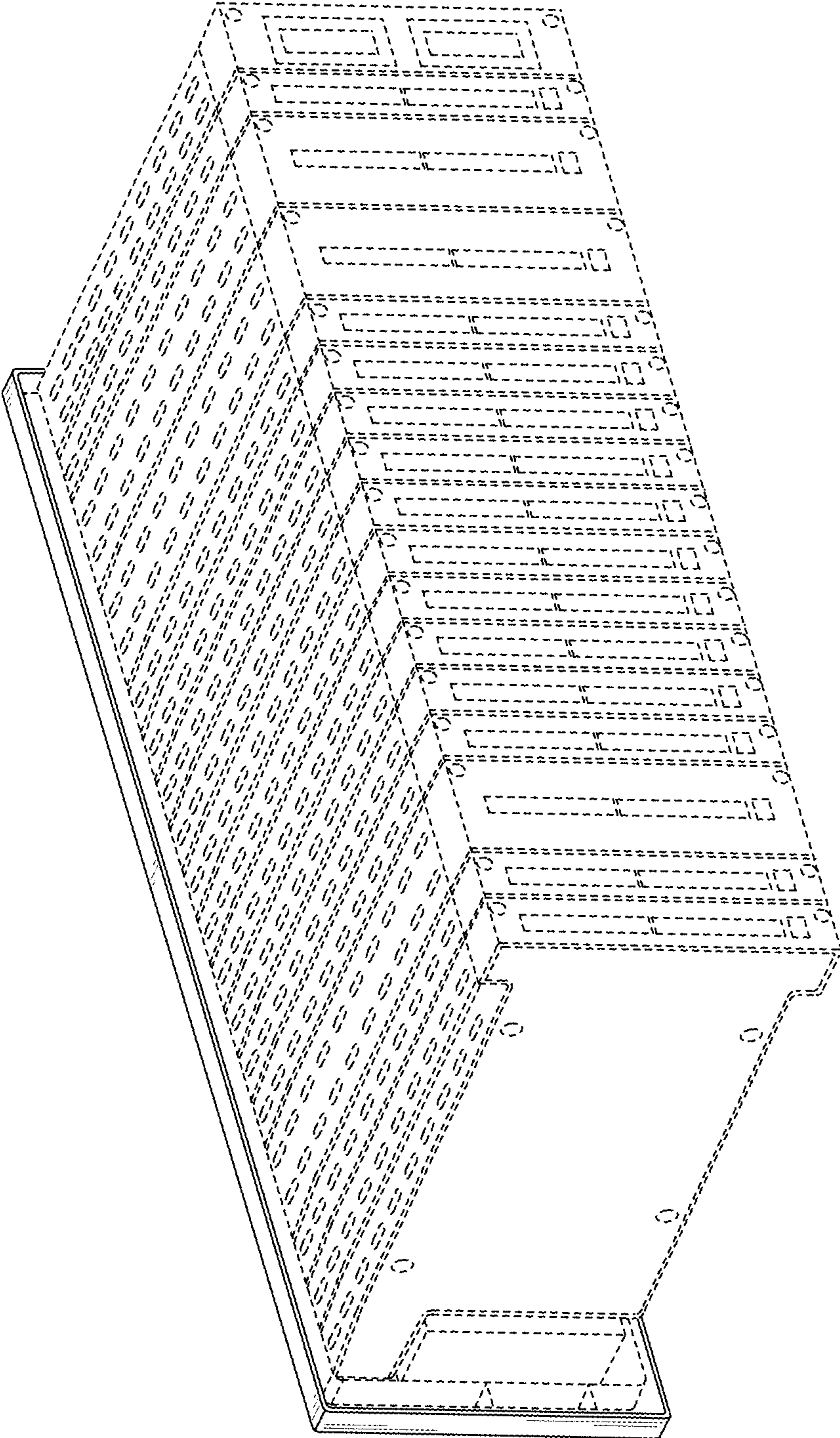

FIG. 2

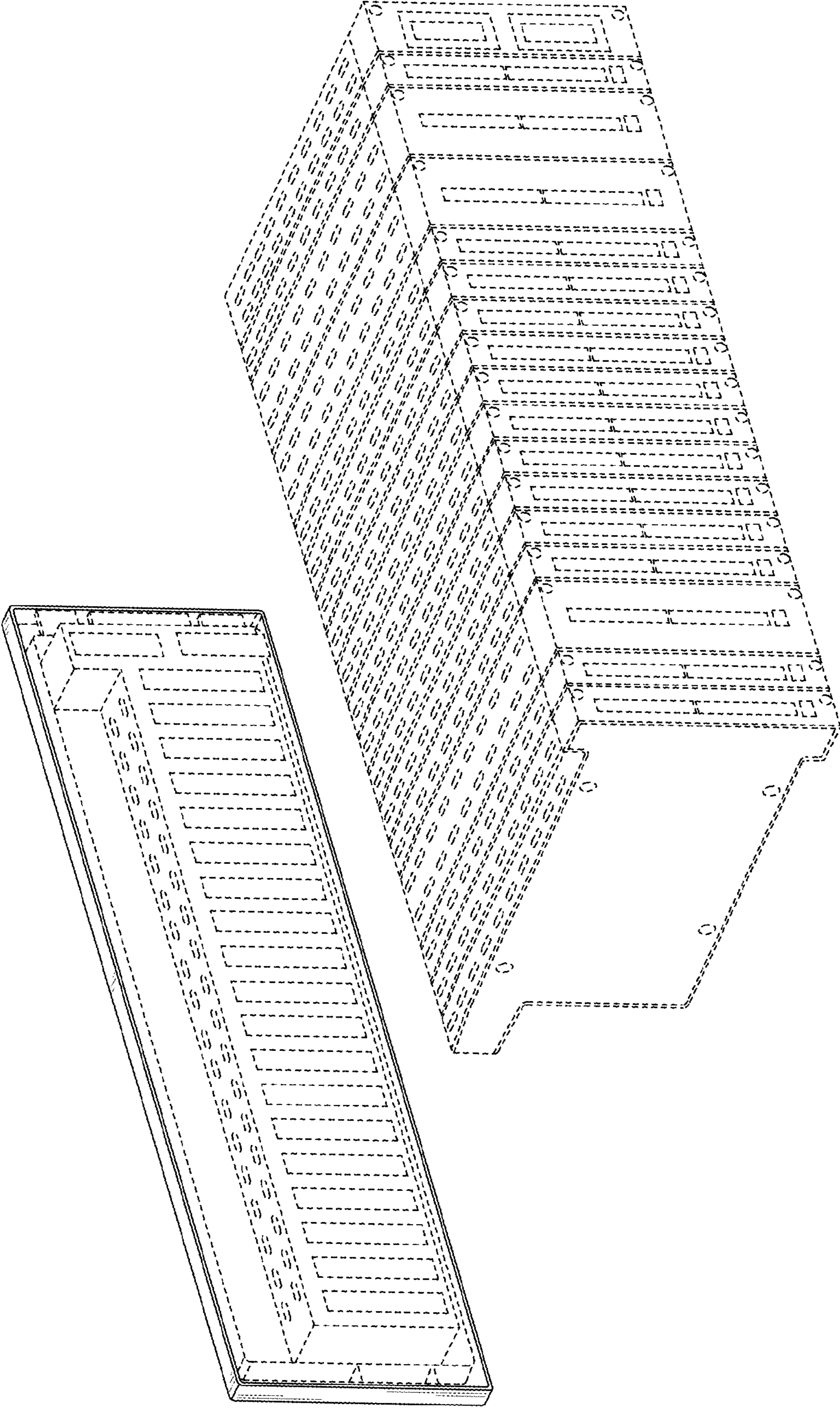

FIG. 3

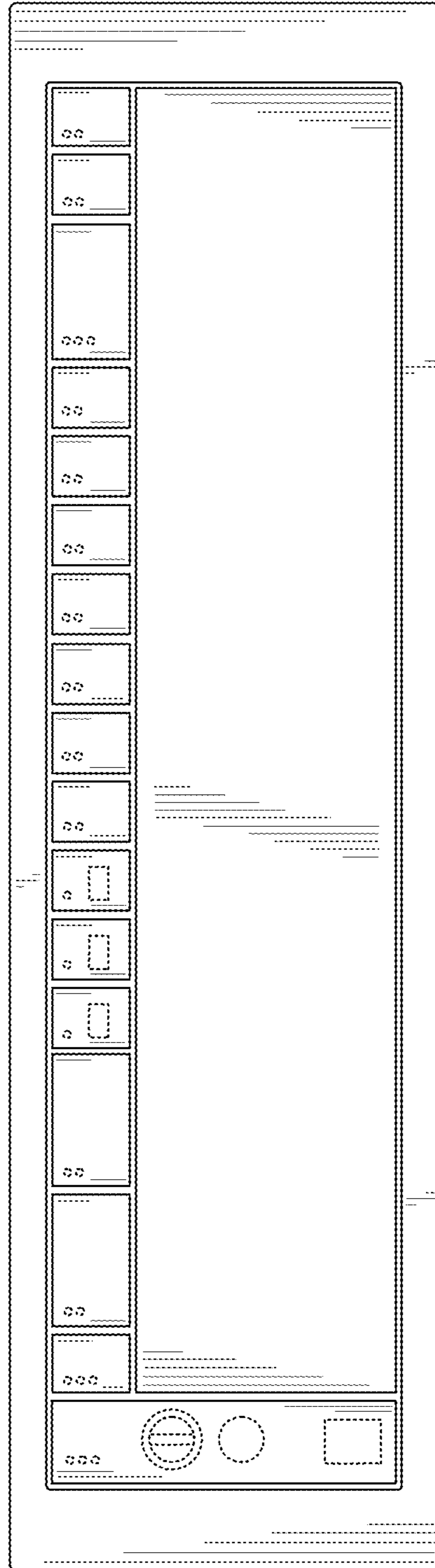

FIG. 4

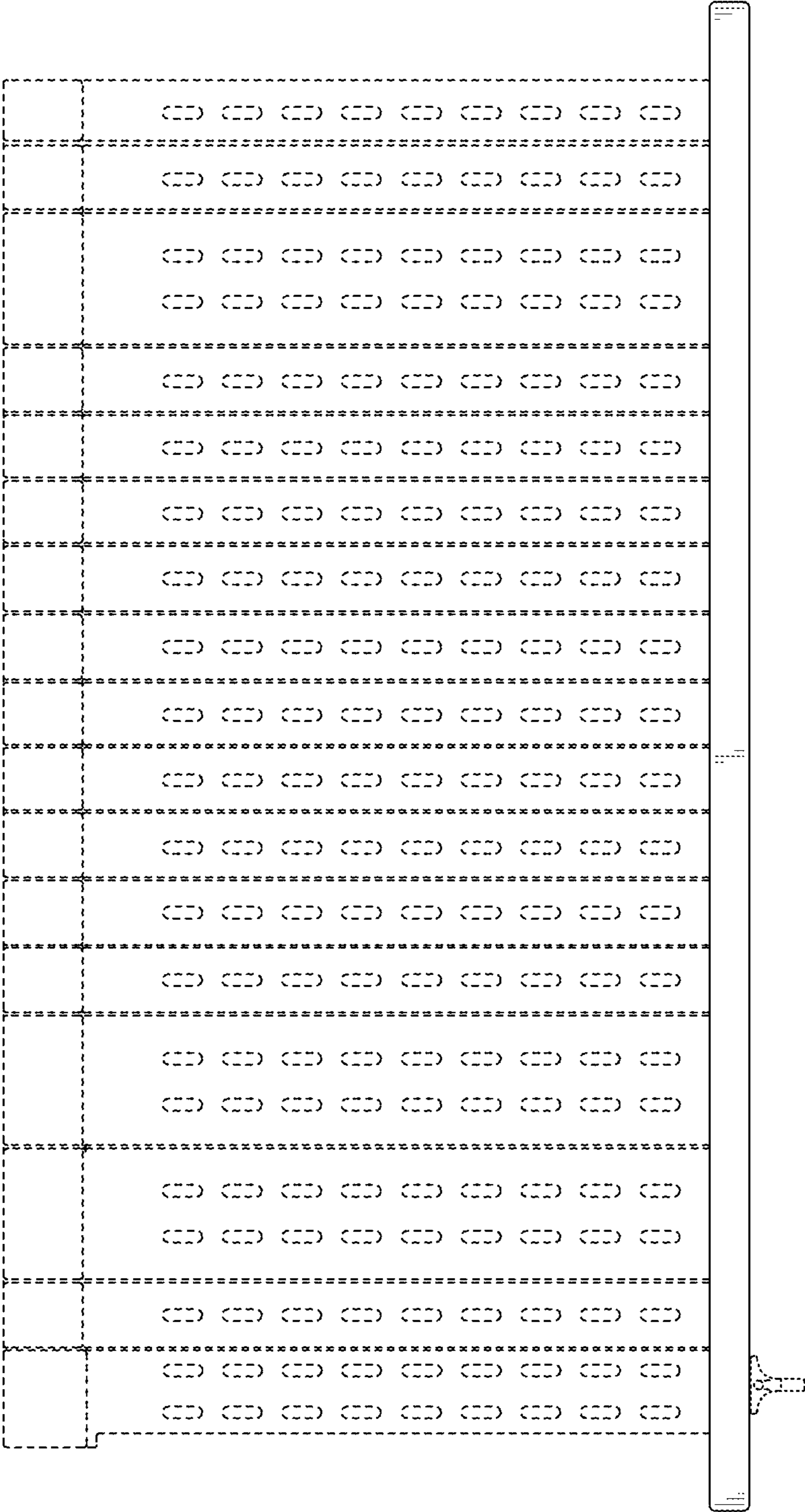

FIG. 5

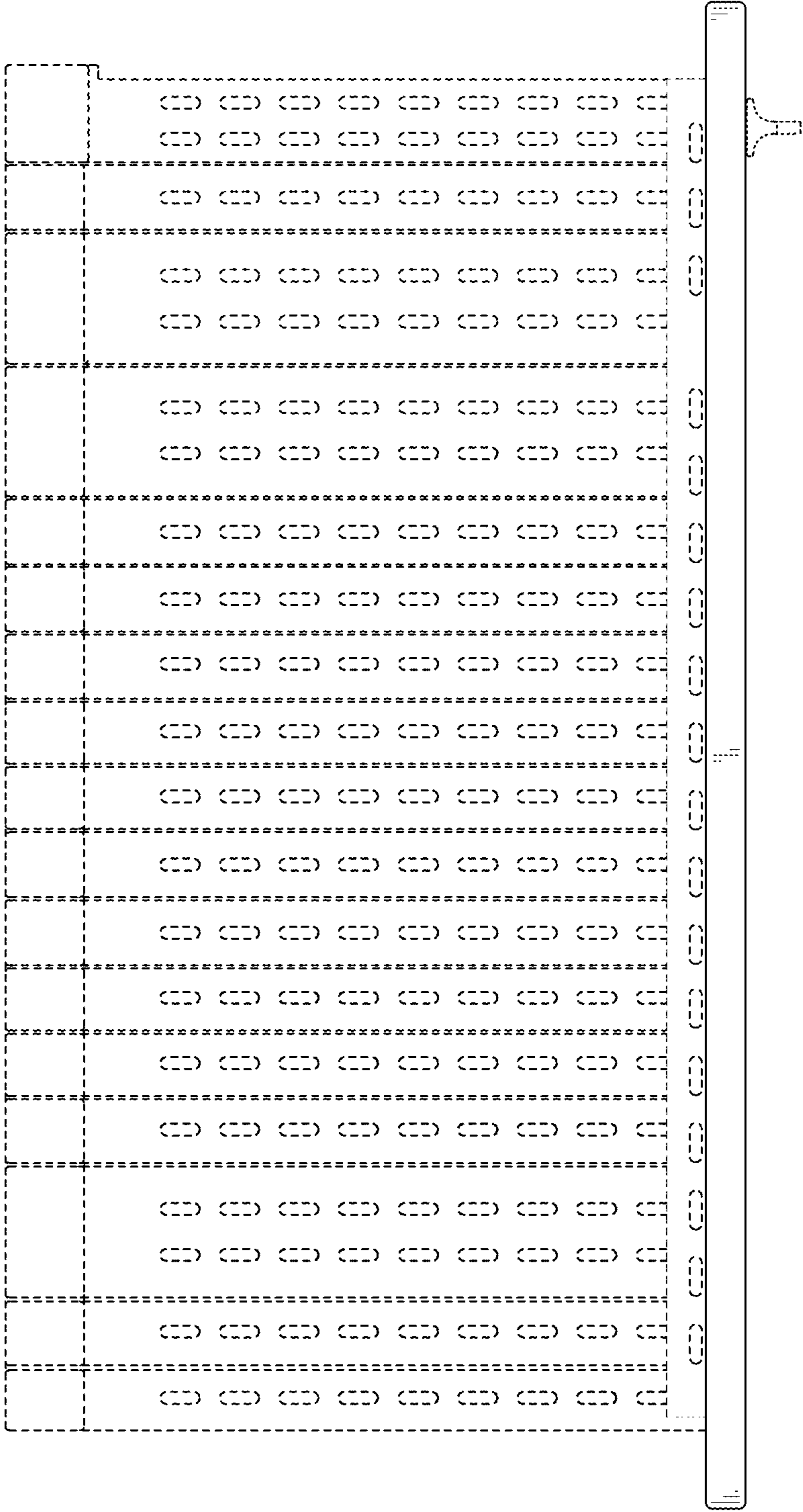

FIG. 6



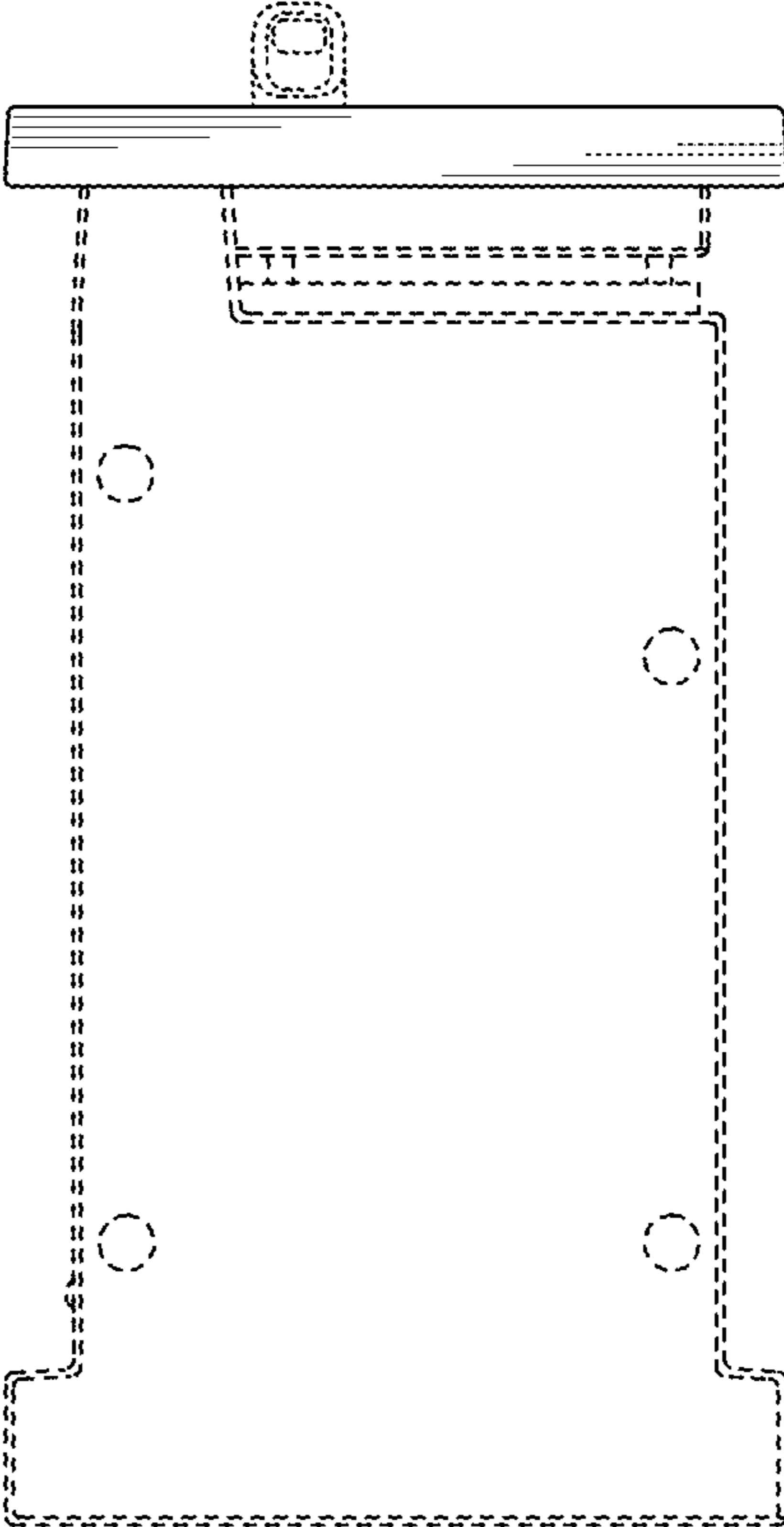

FIG. 7

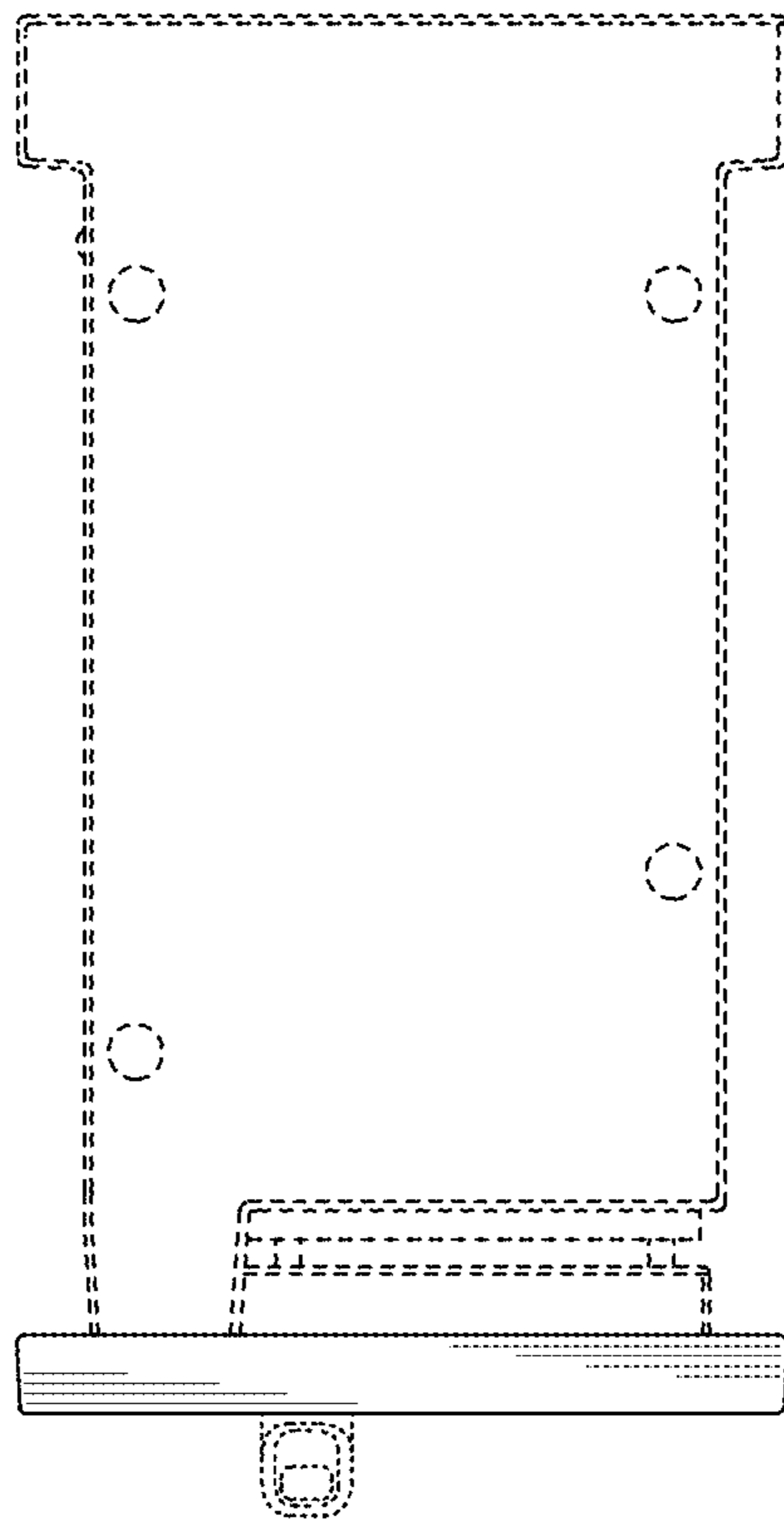

FIG. 8

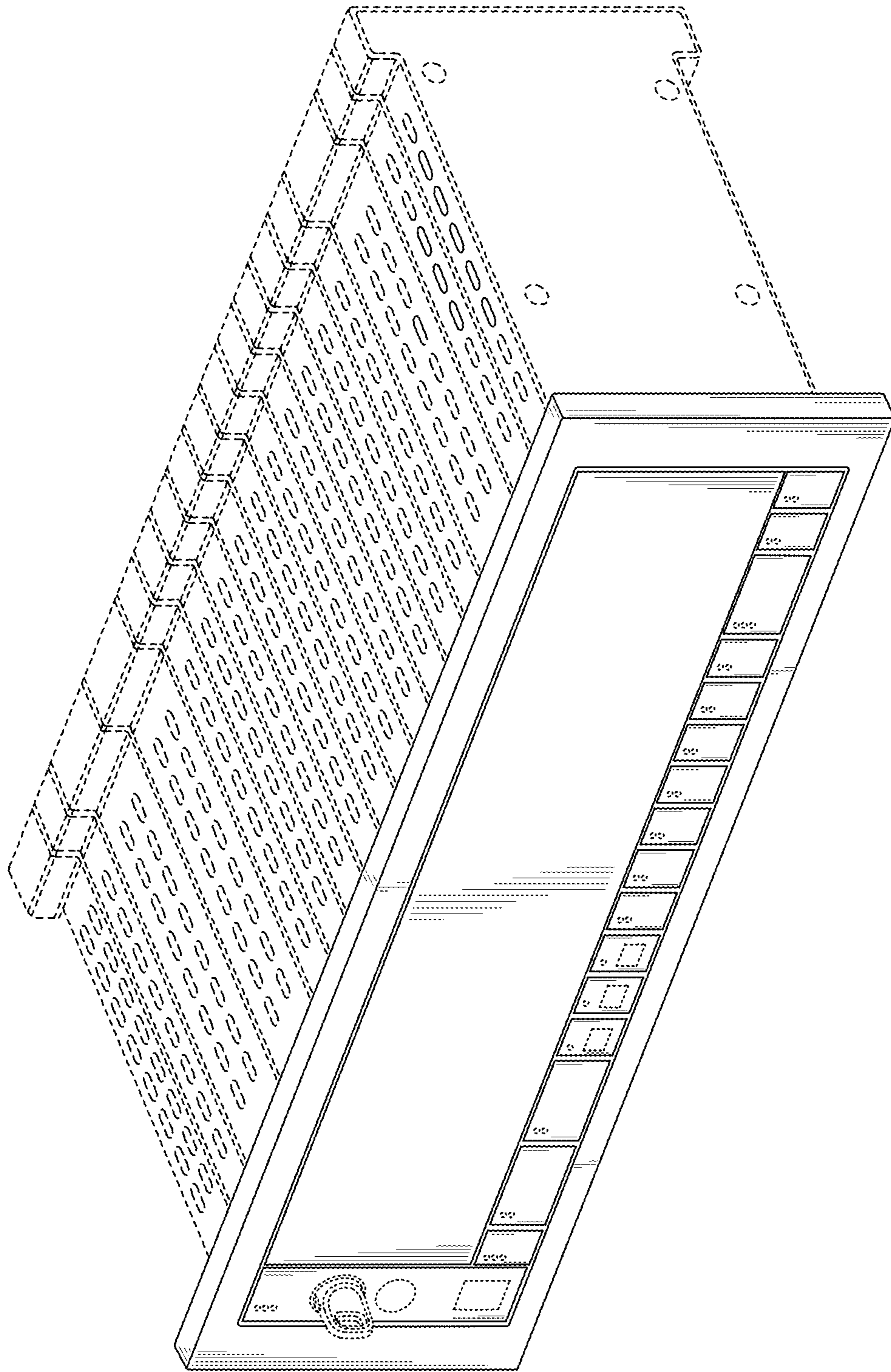

FIG. 9

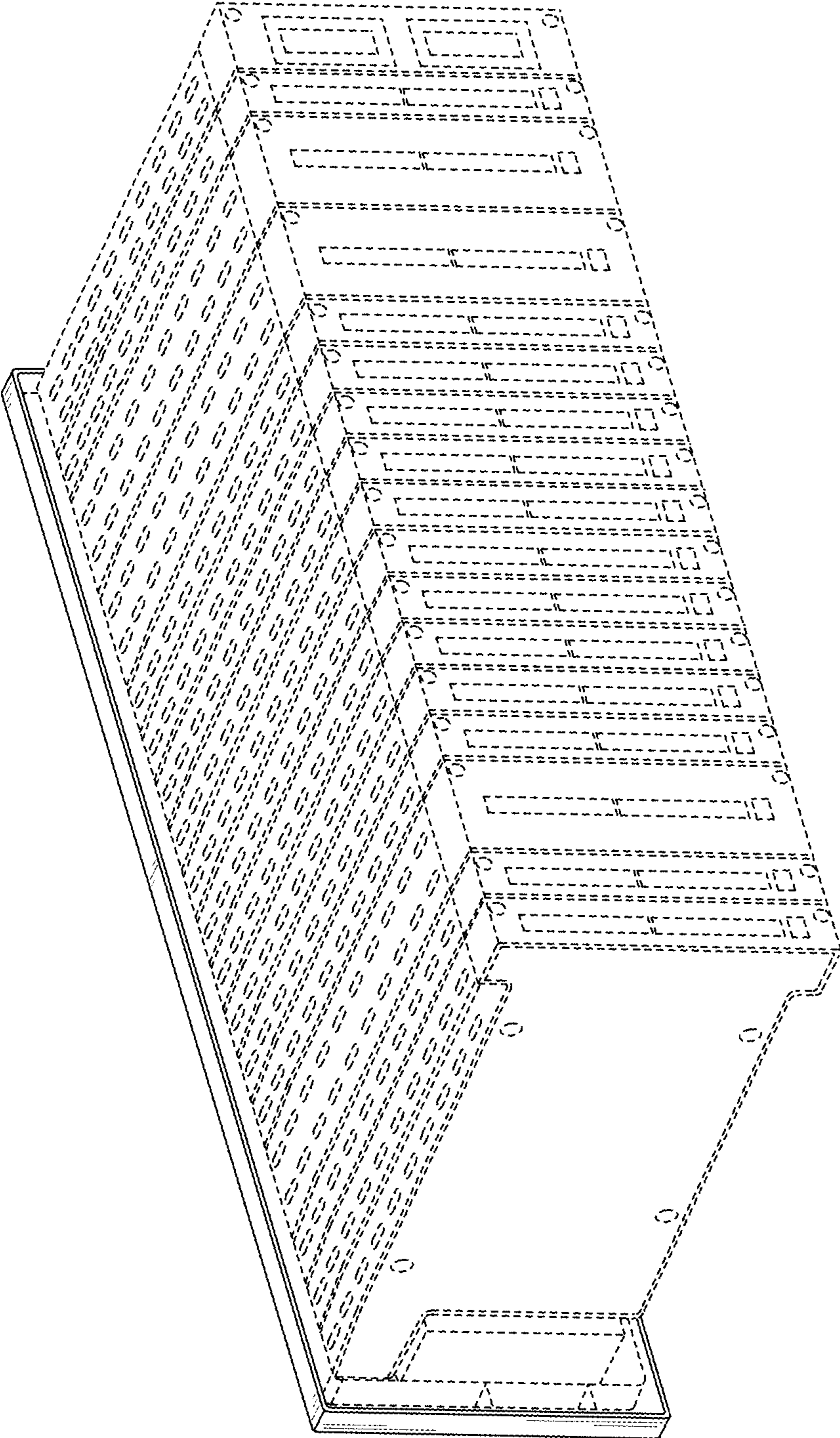

FIG. 10

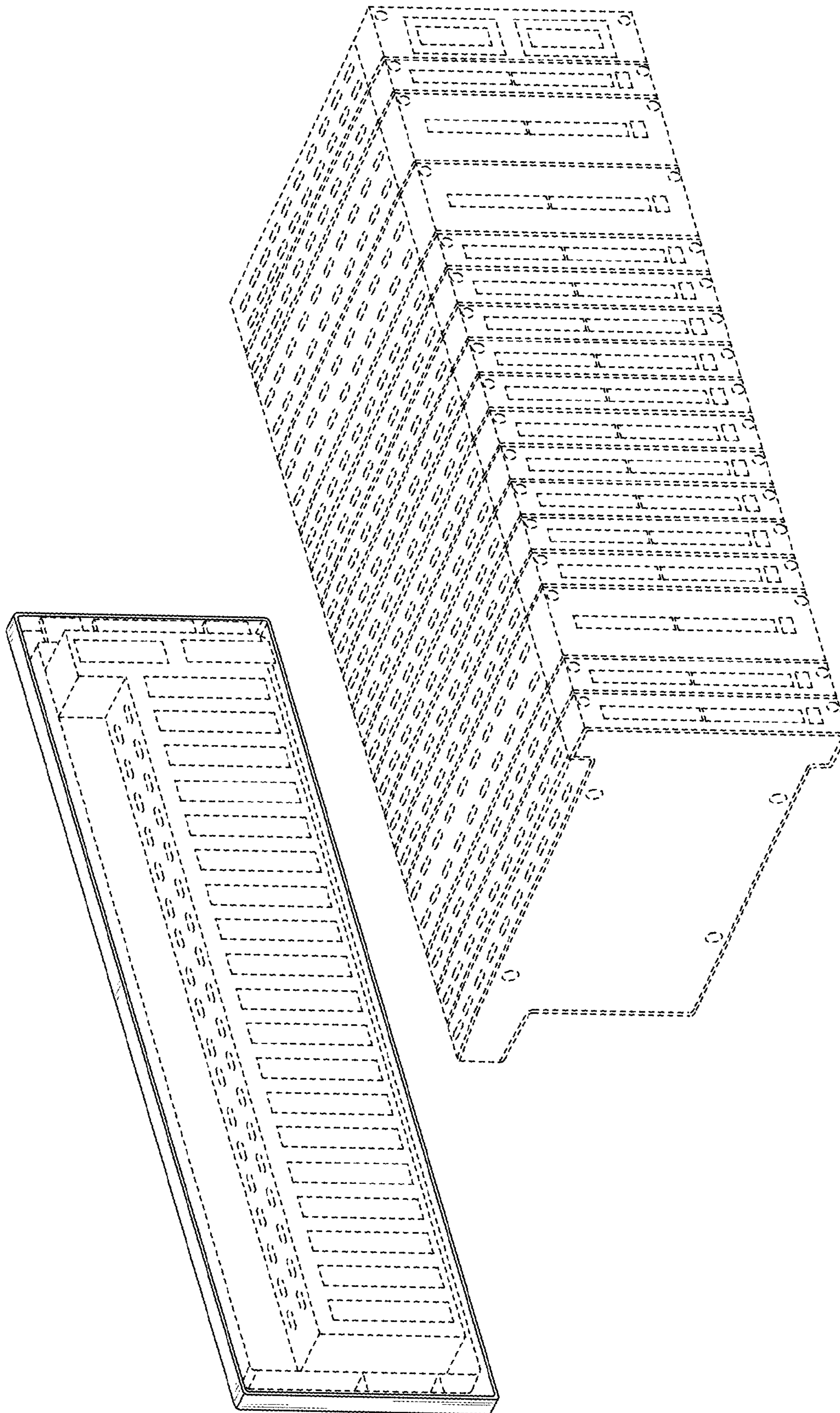

FIG. 11

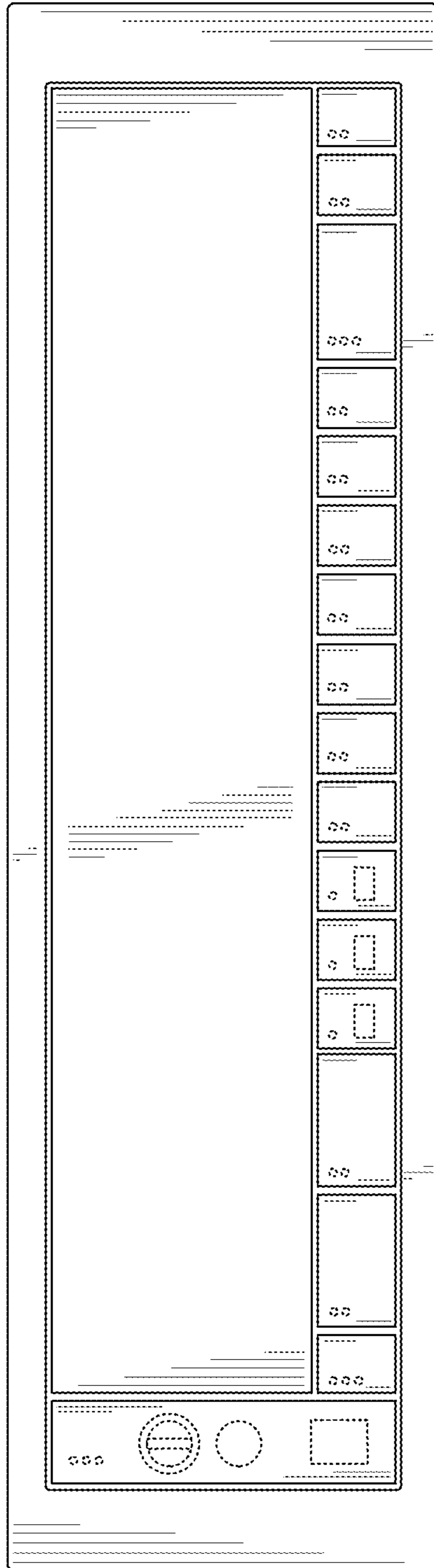

FIG. 12

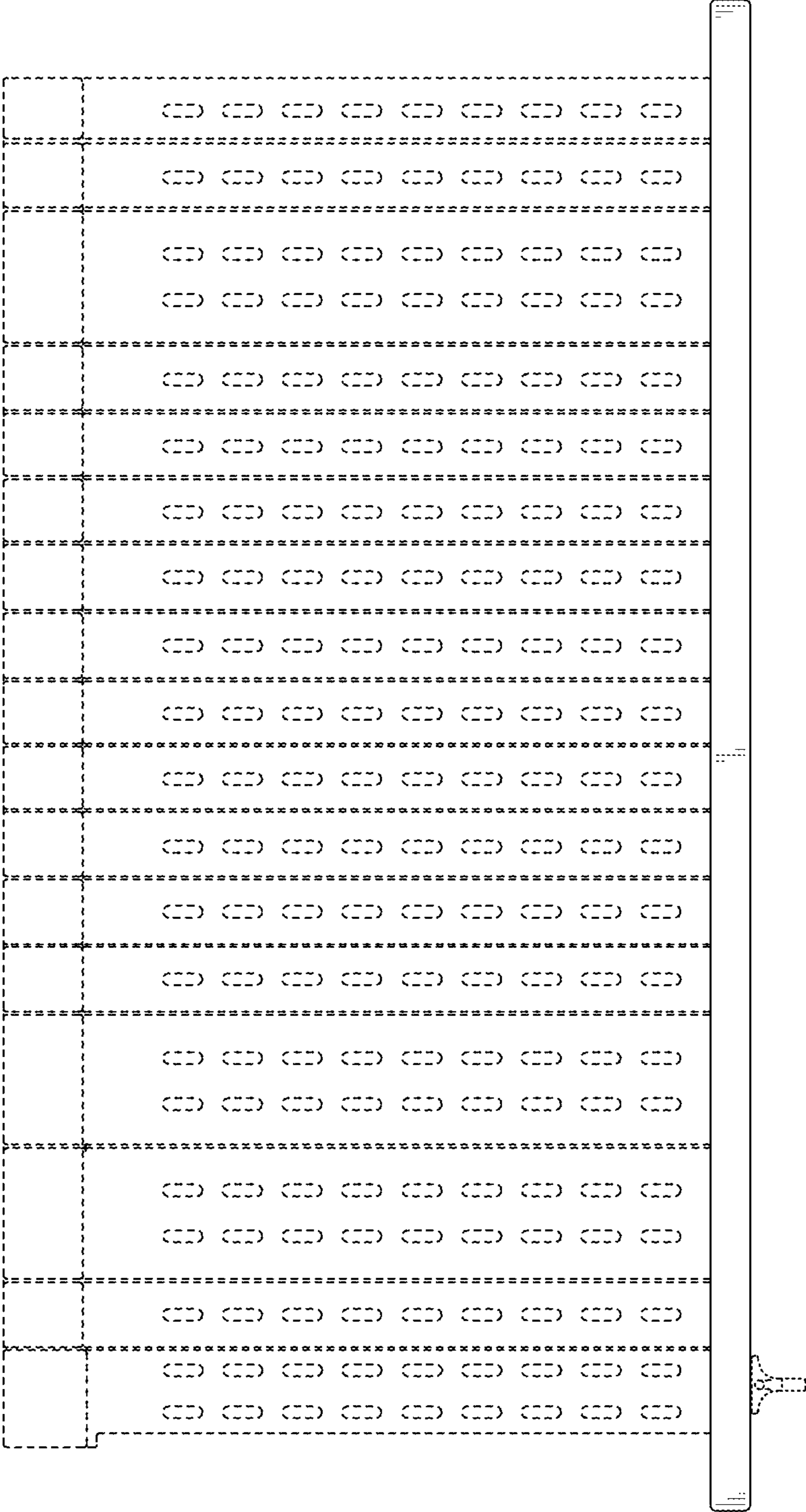

FIG. 13

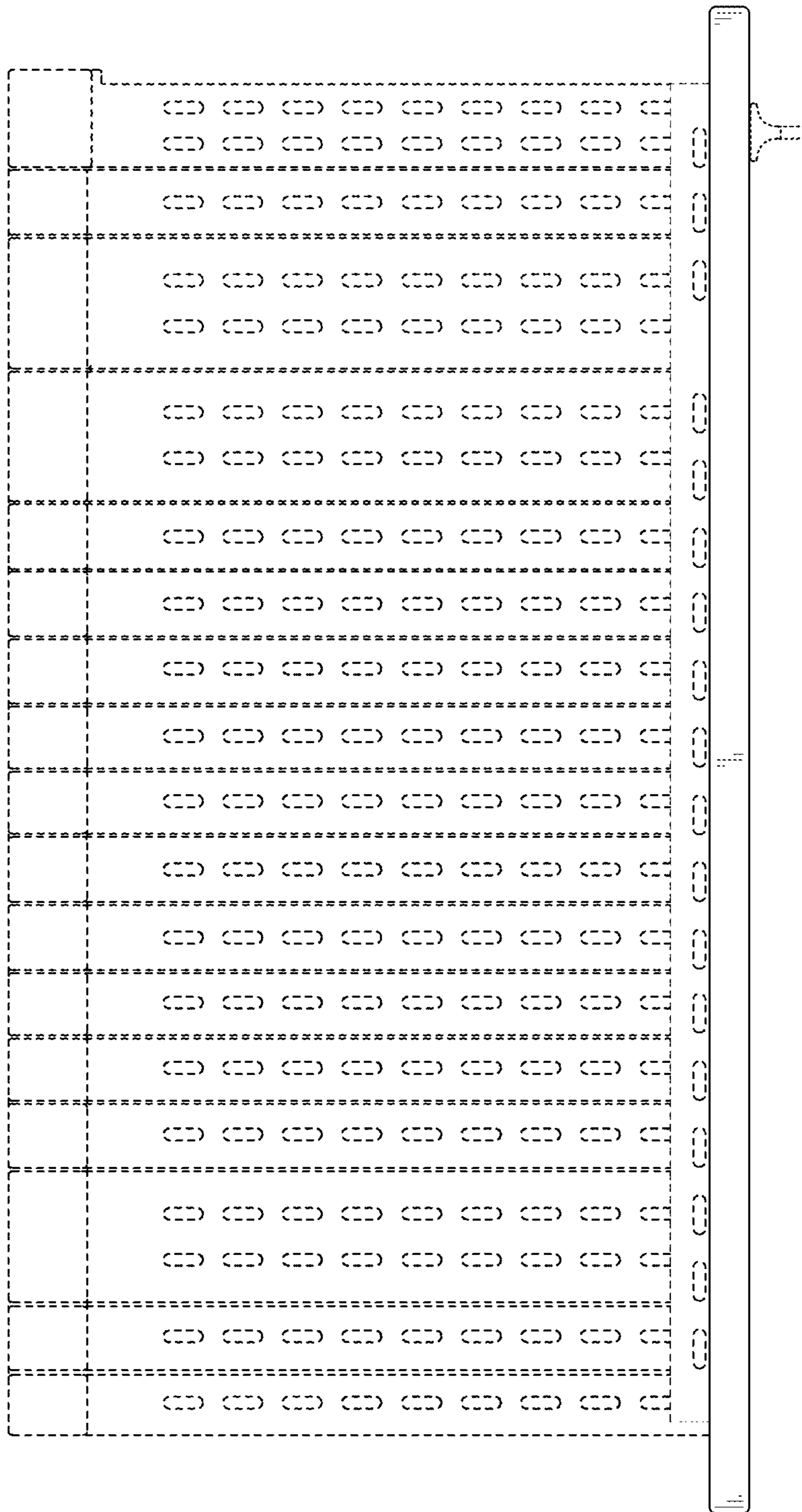

FIG. 14



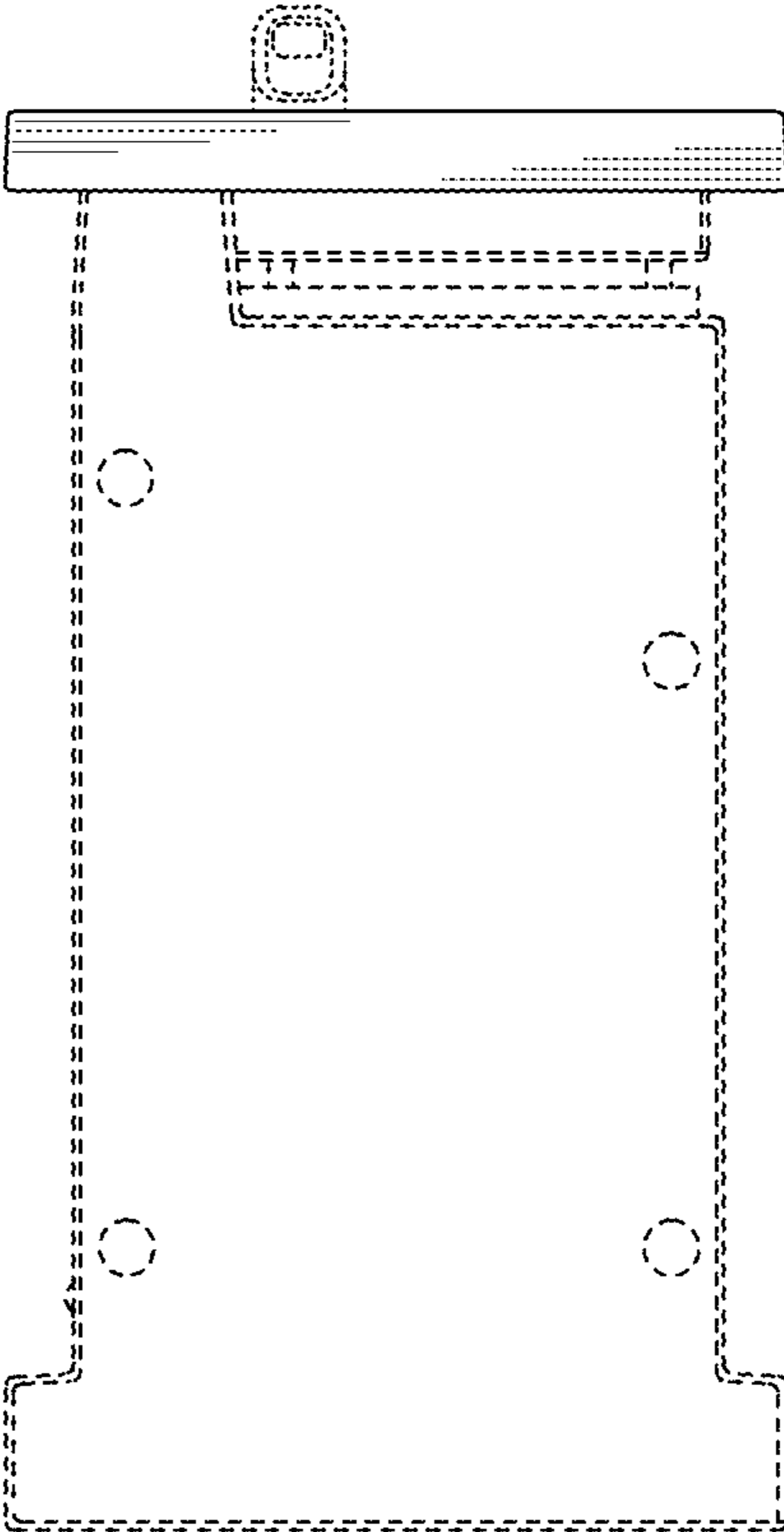

FIG. 15

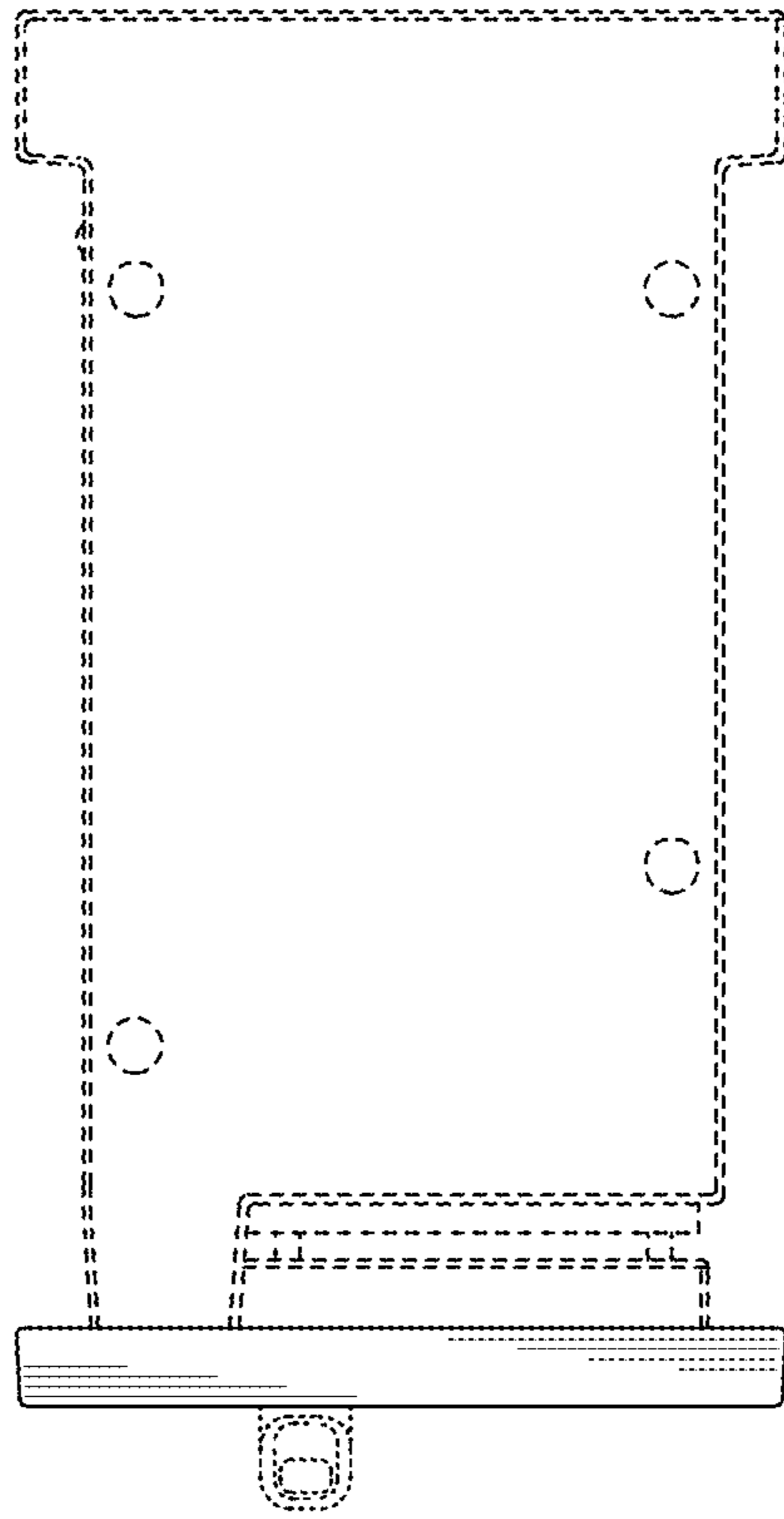

FIG. 16

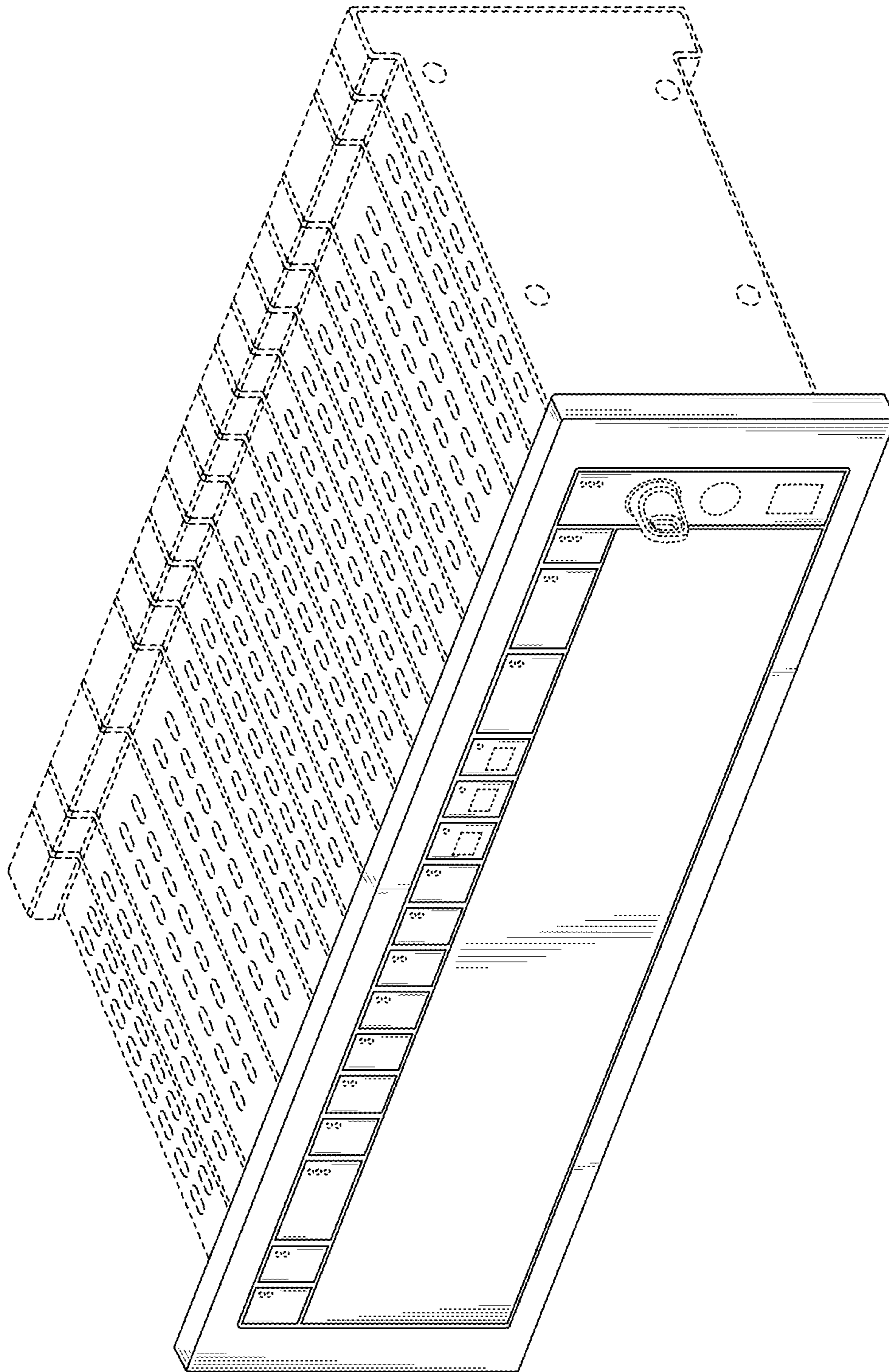

FIG. 17

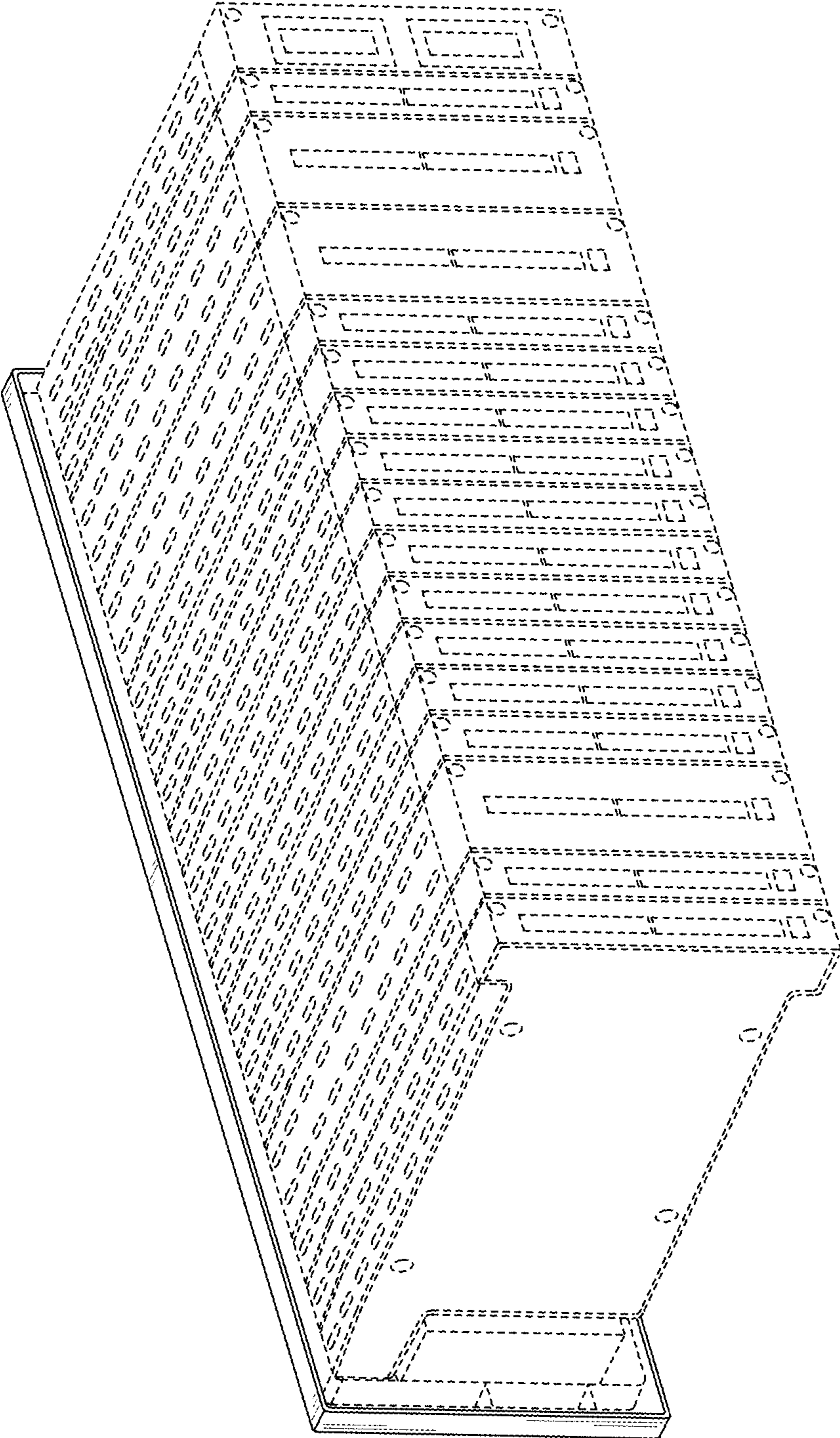

FIG. 18

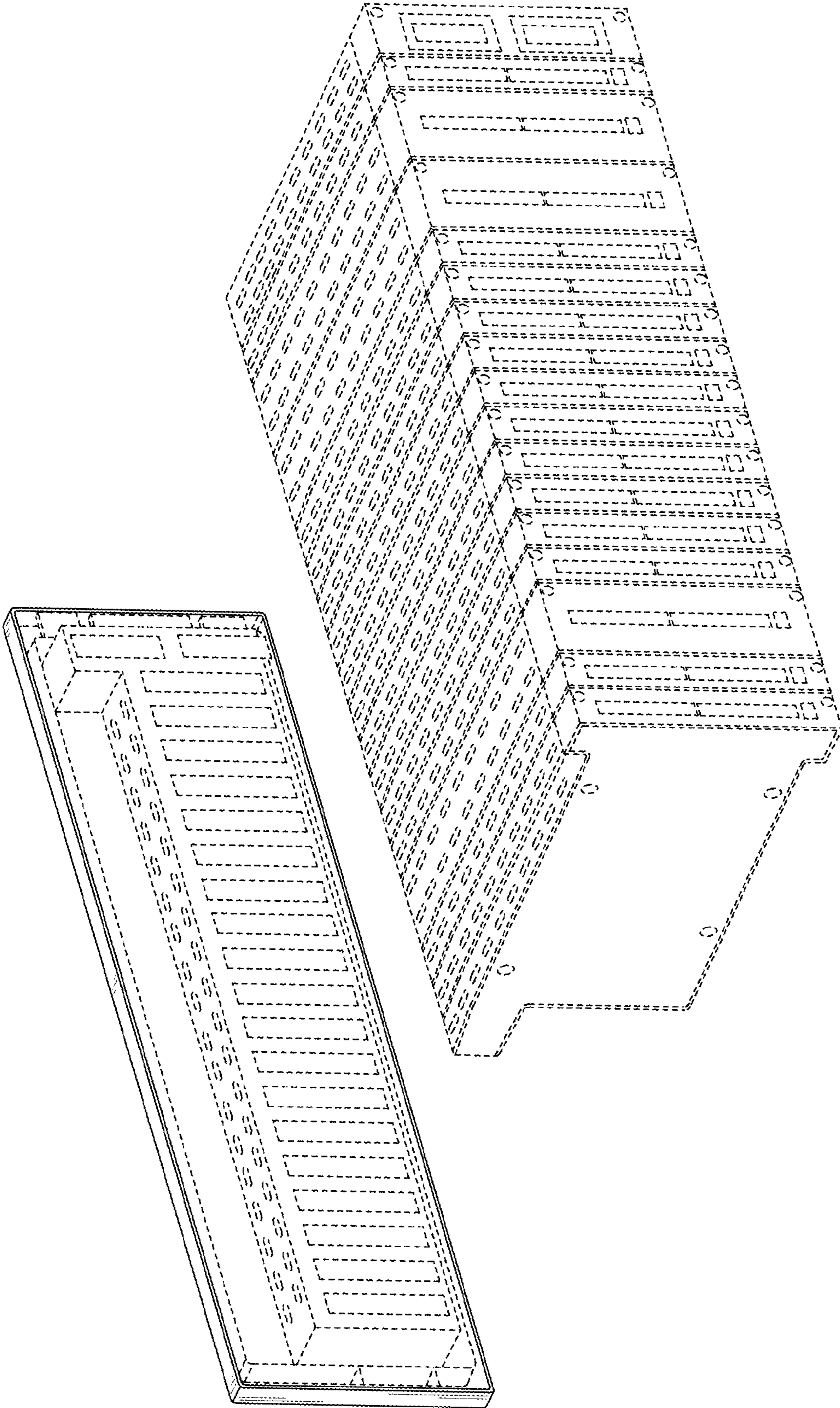

FIG. 19

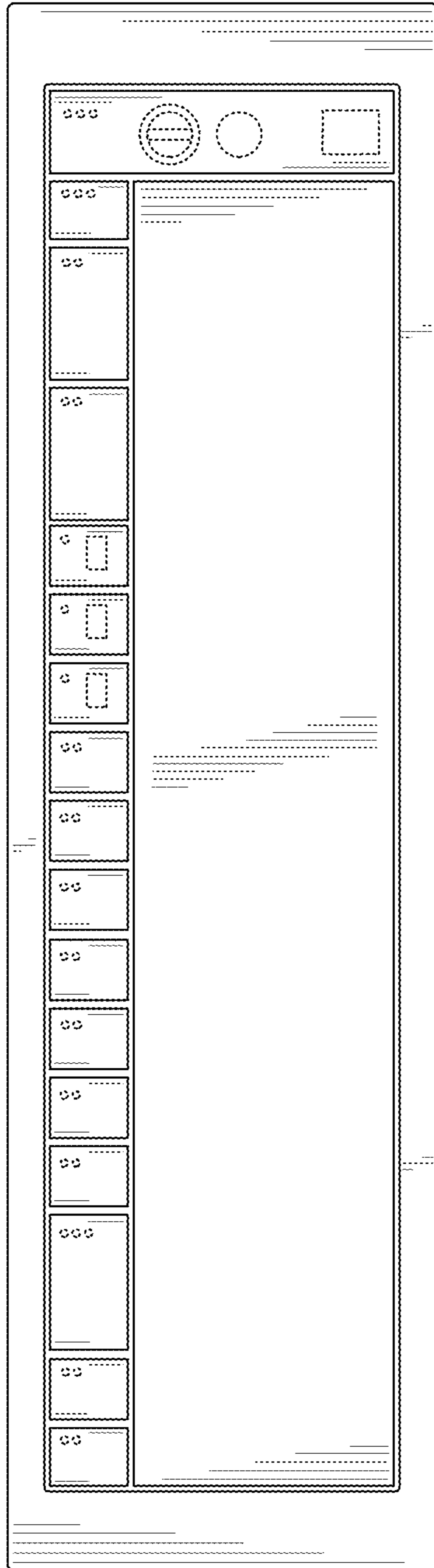

FIG. 20

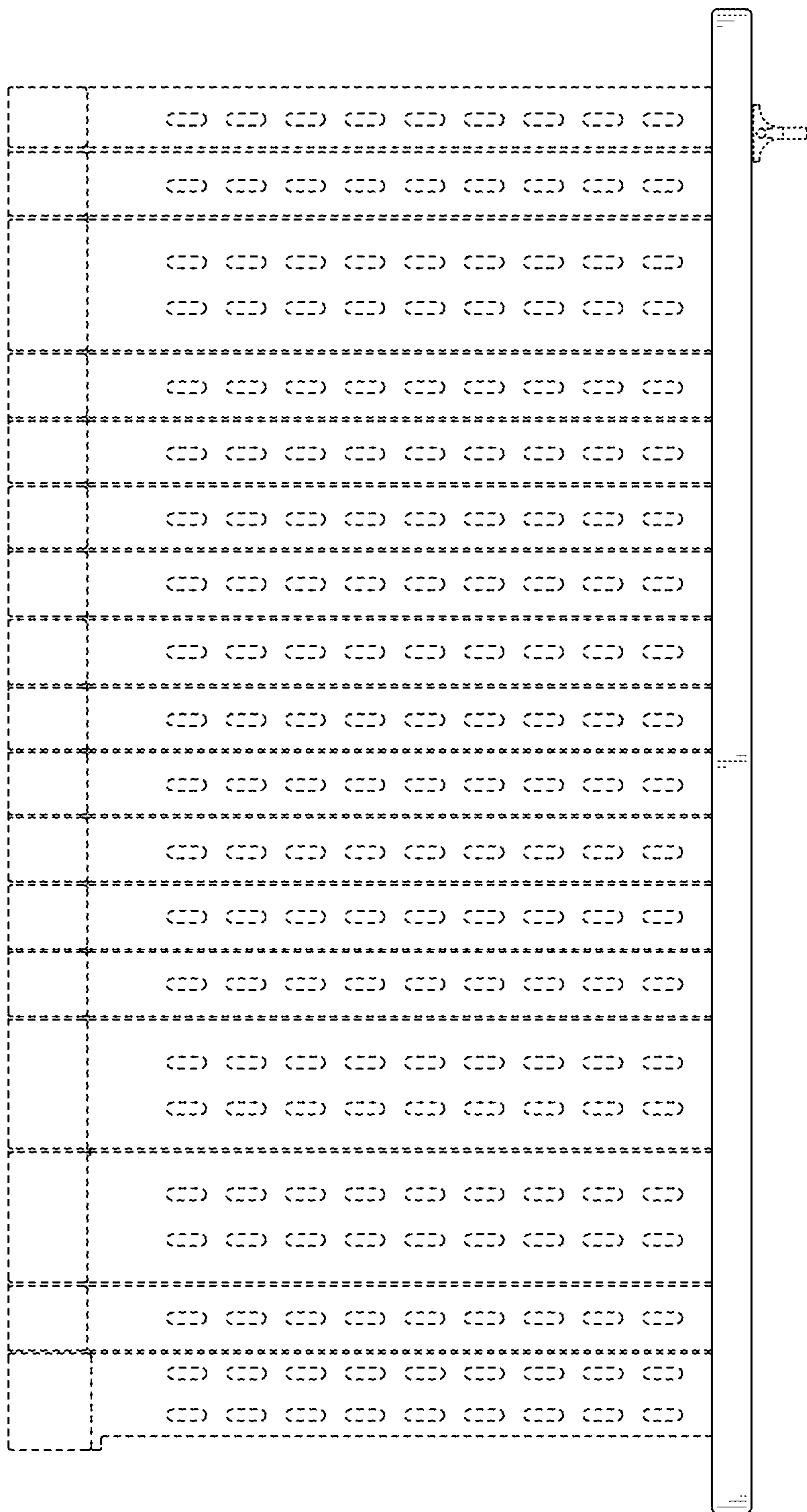

FIG. 21

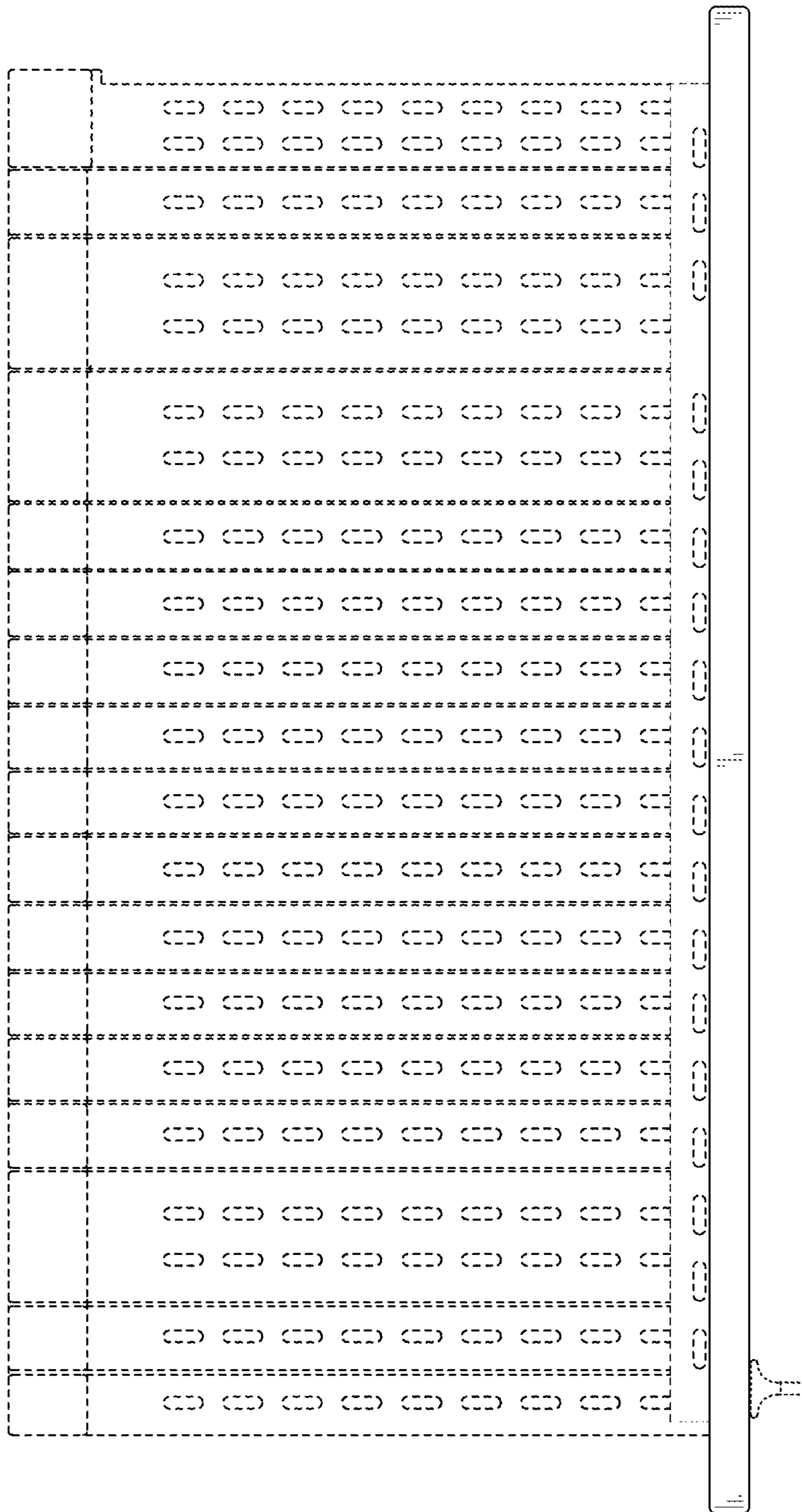

FIG. 22



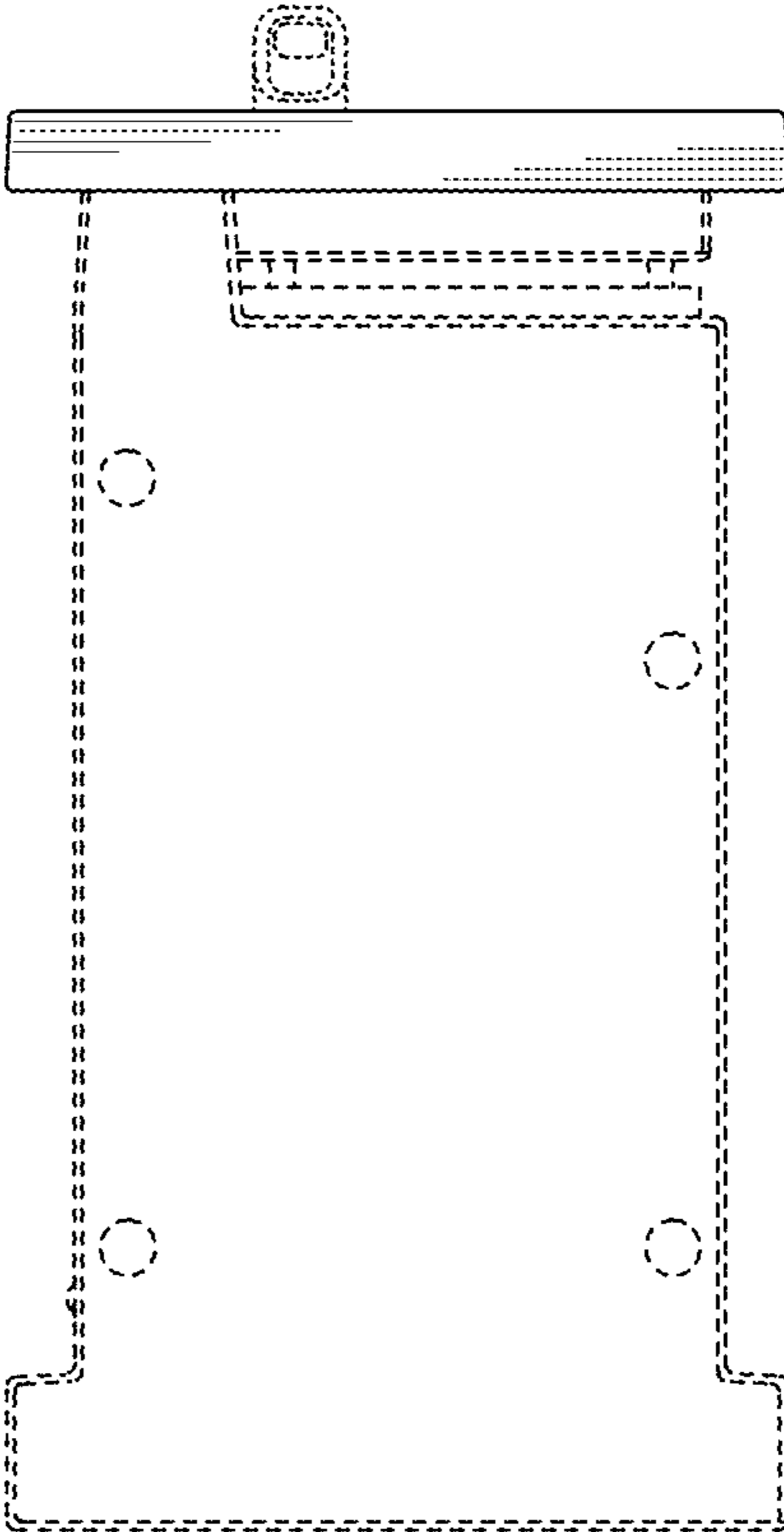

FIG. 23

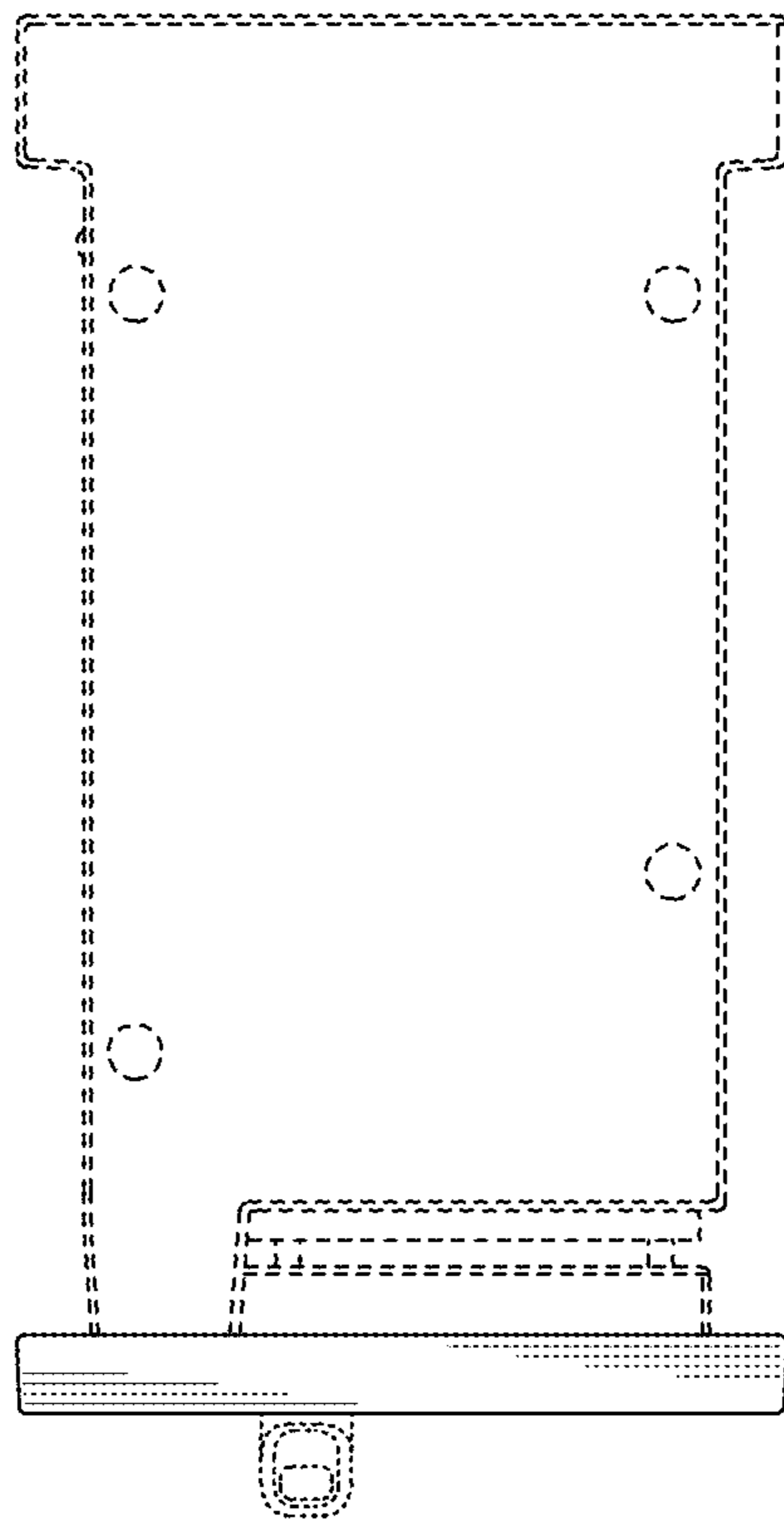

FIG. 24

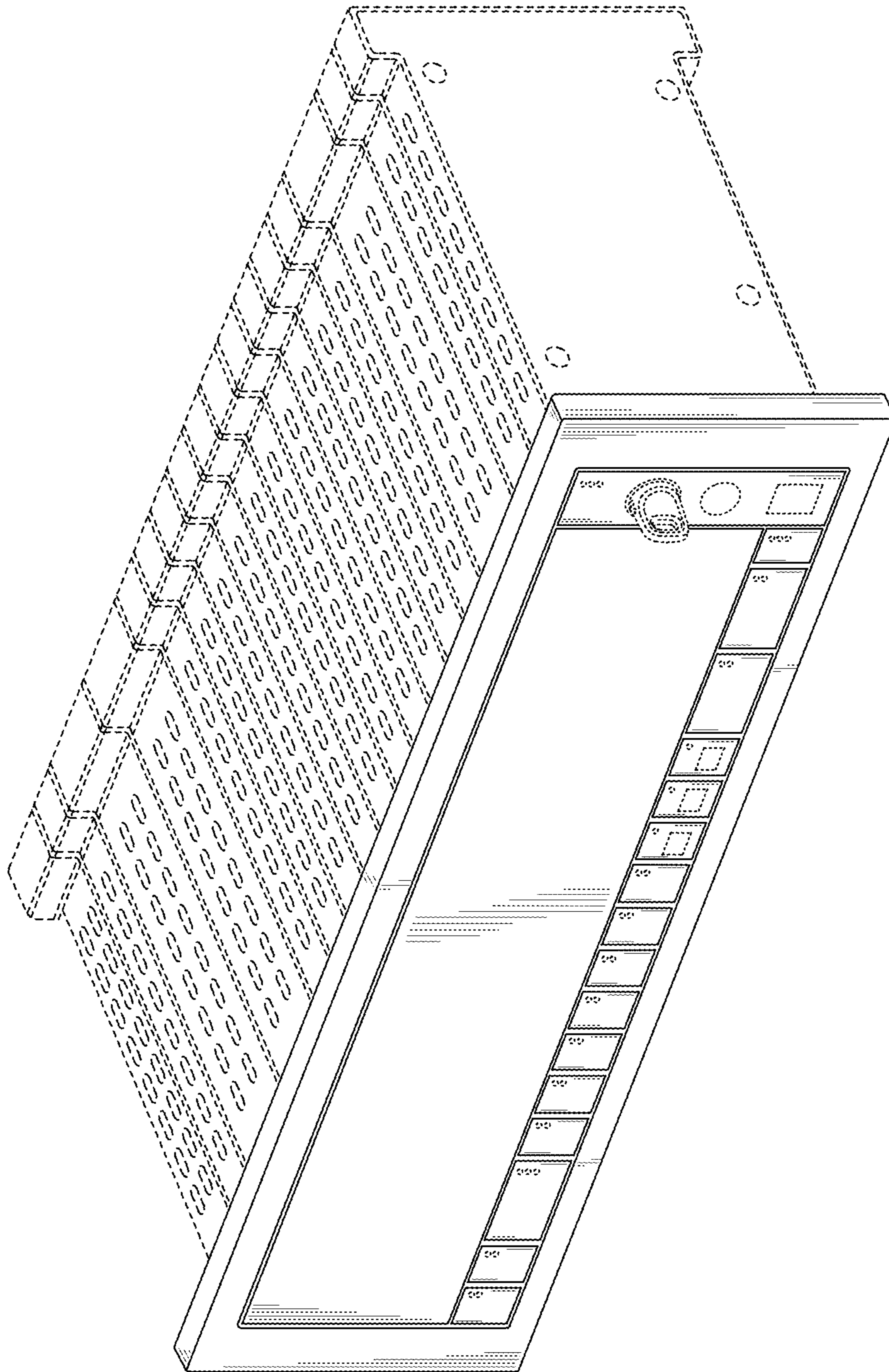

FIG. 25

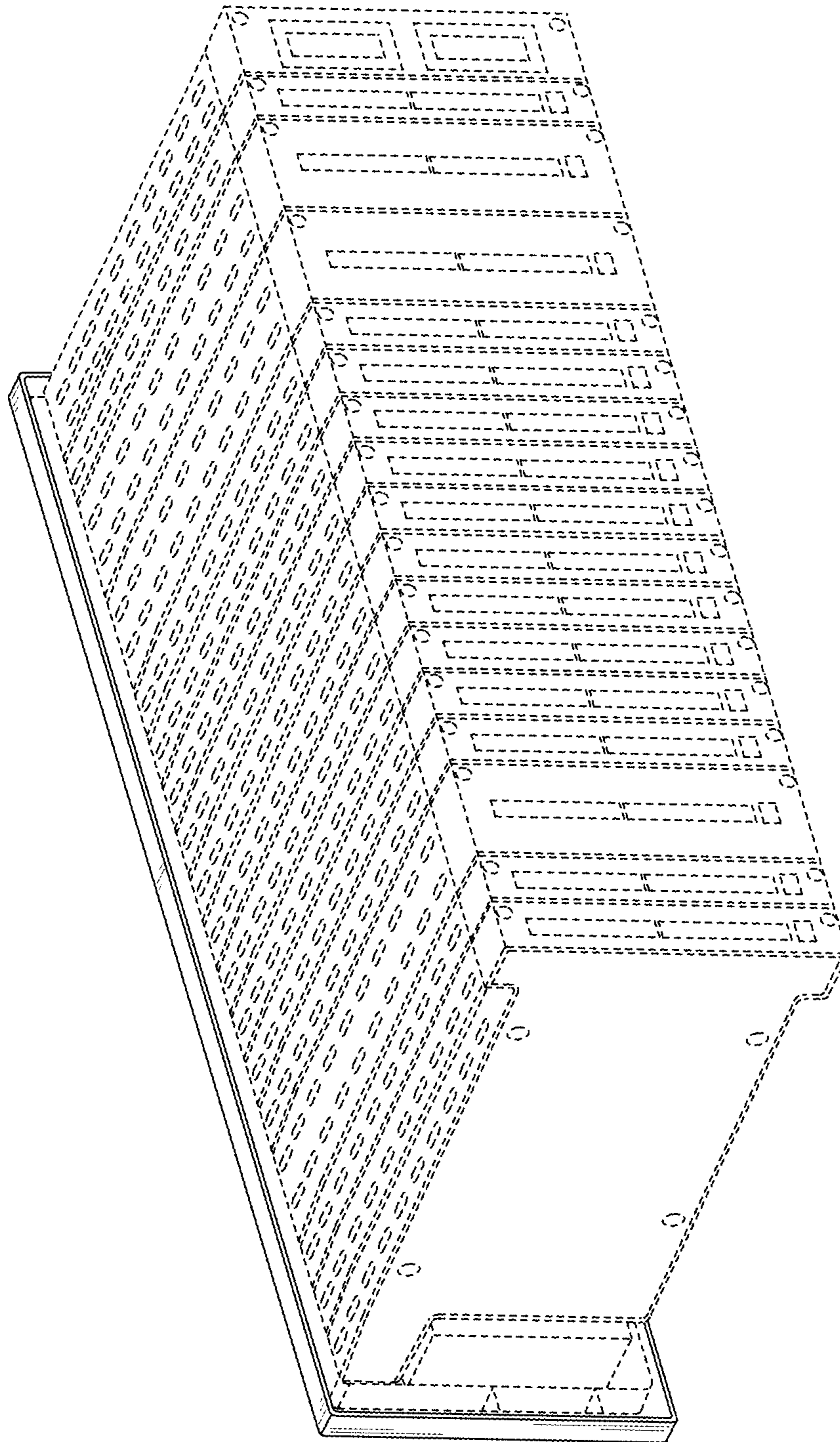

FIG. 26

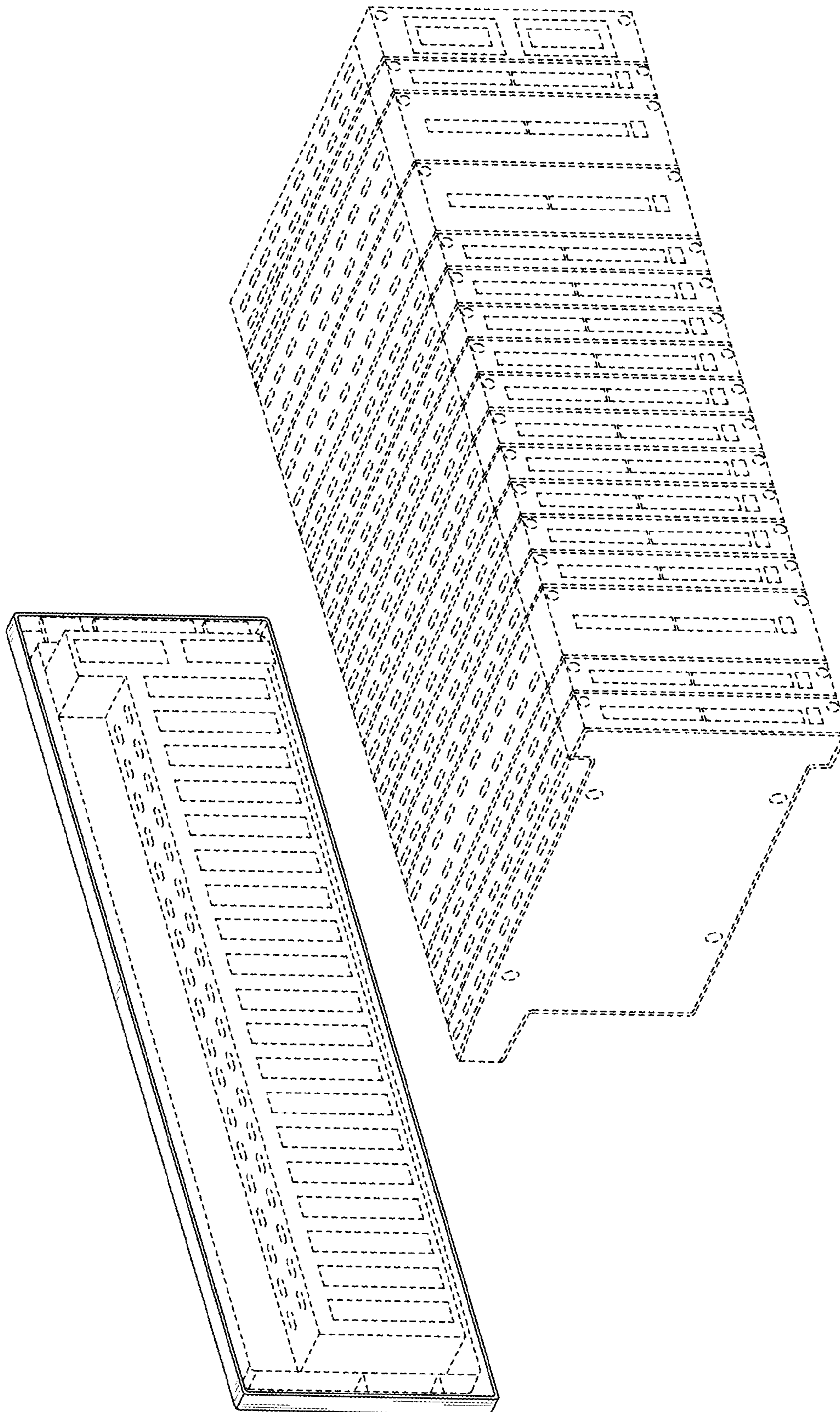

FIG. 27

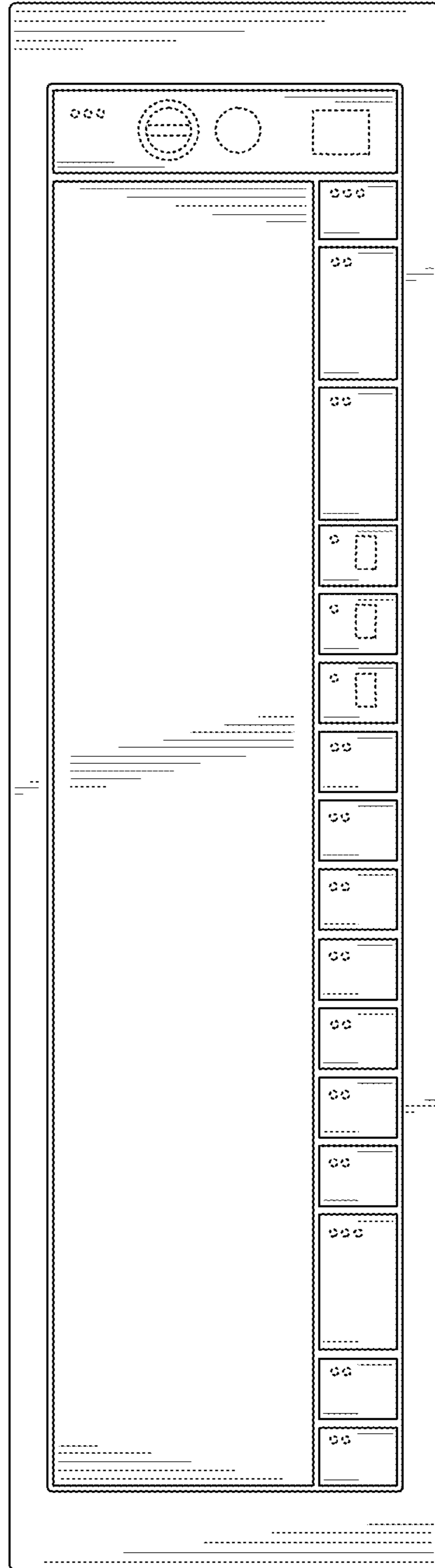

FIG. 28

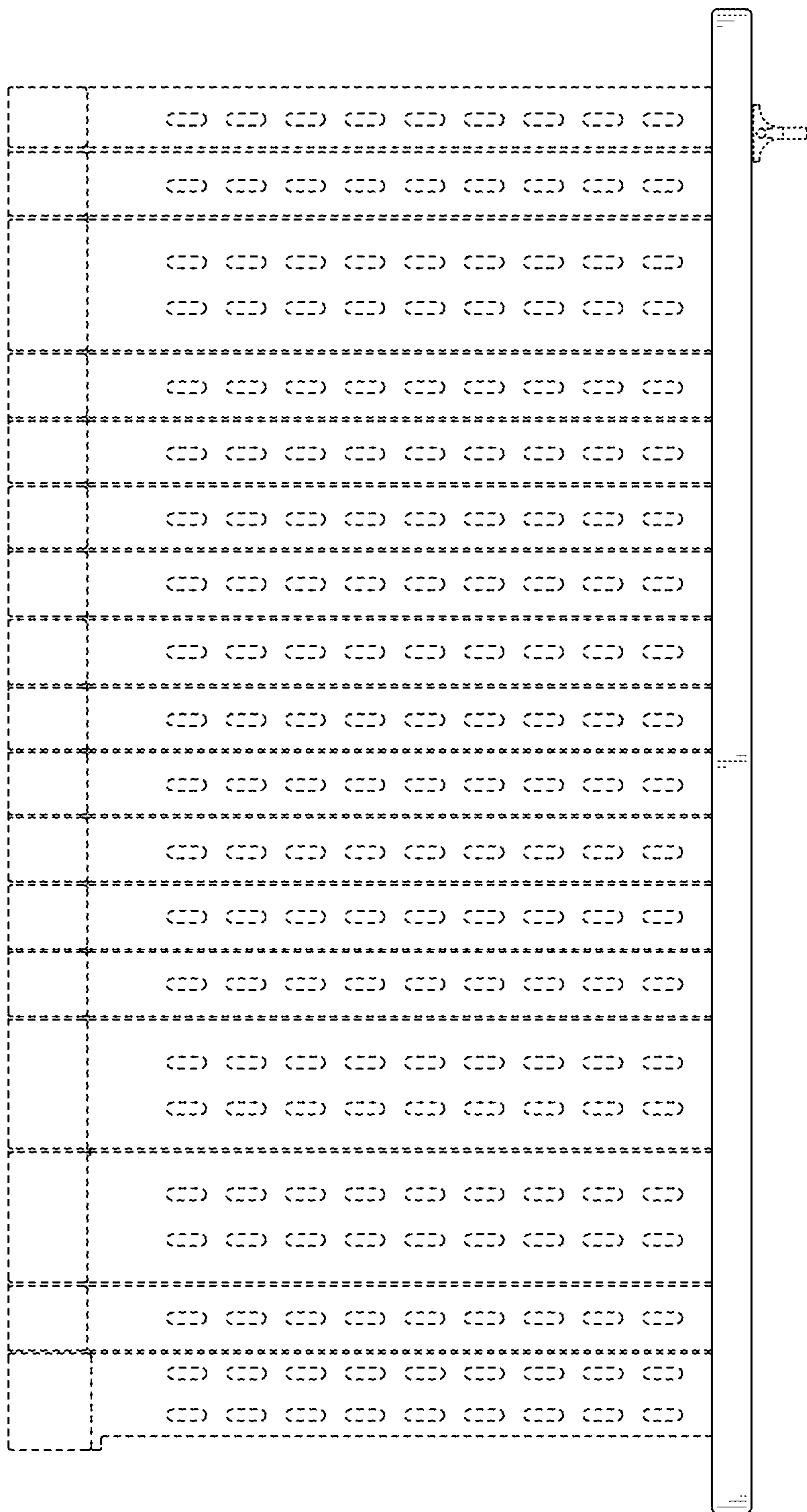

FIG. 29

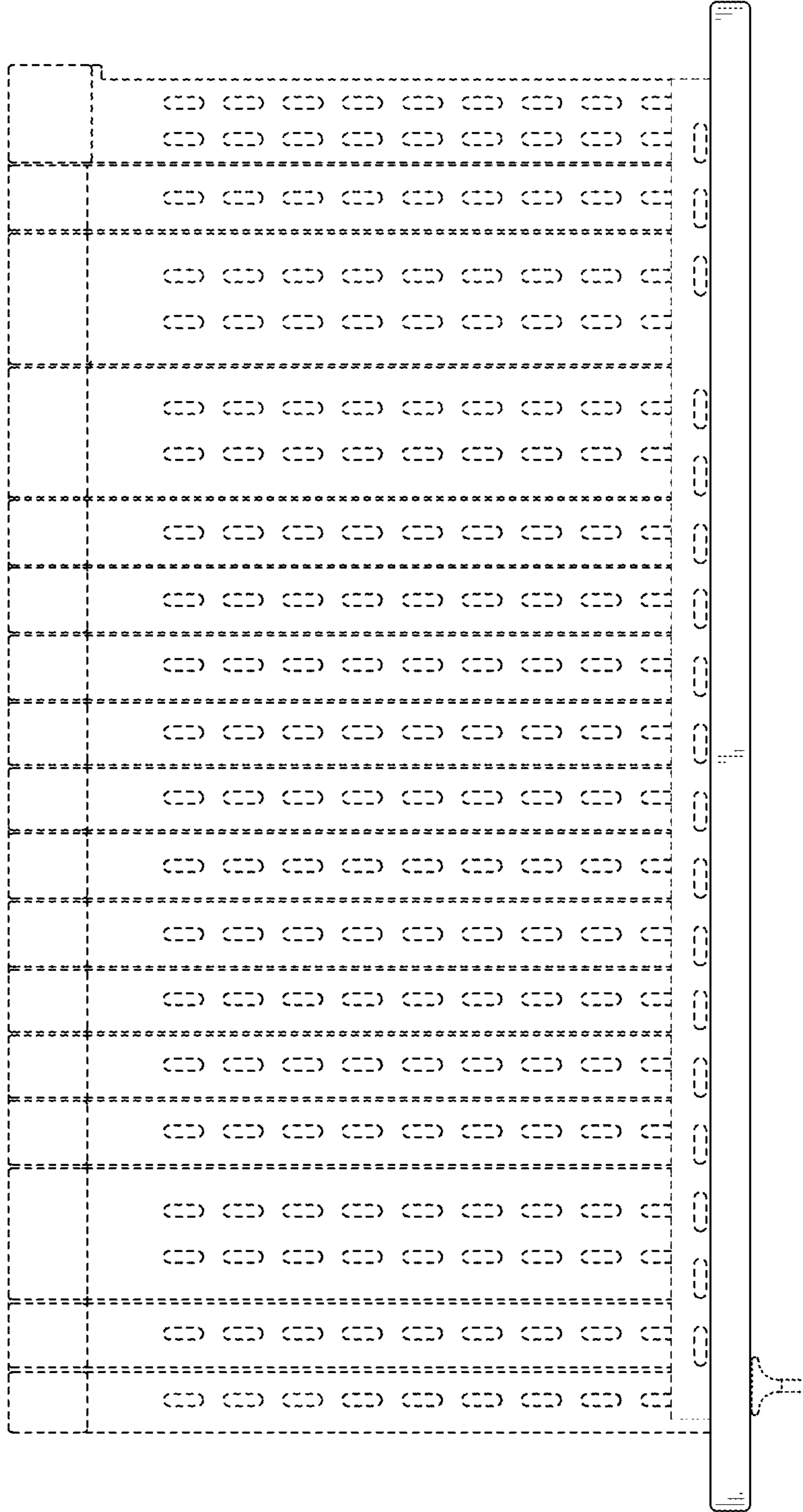

FIG. 30



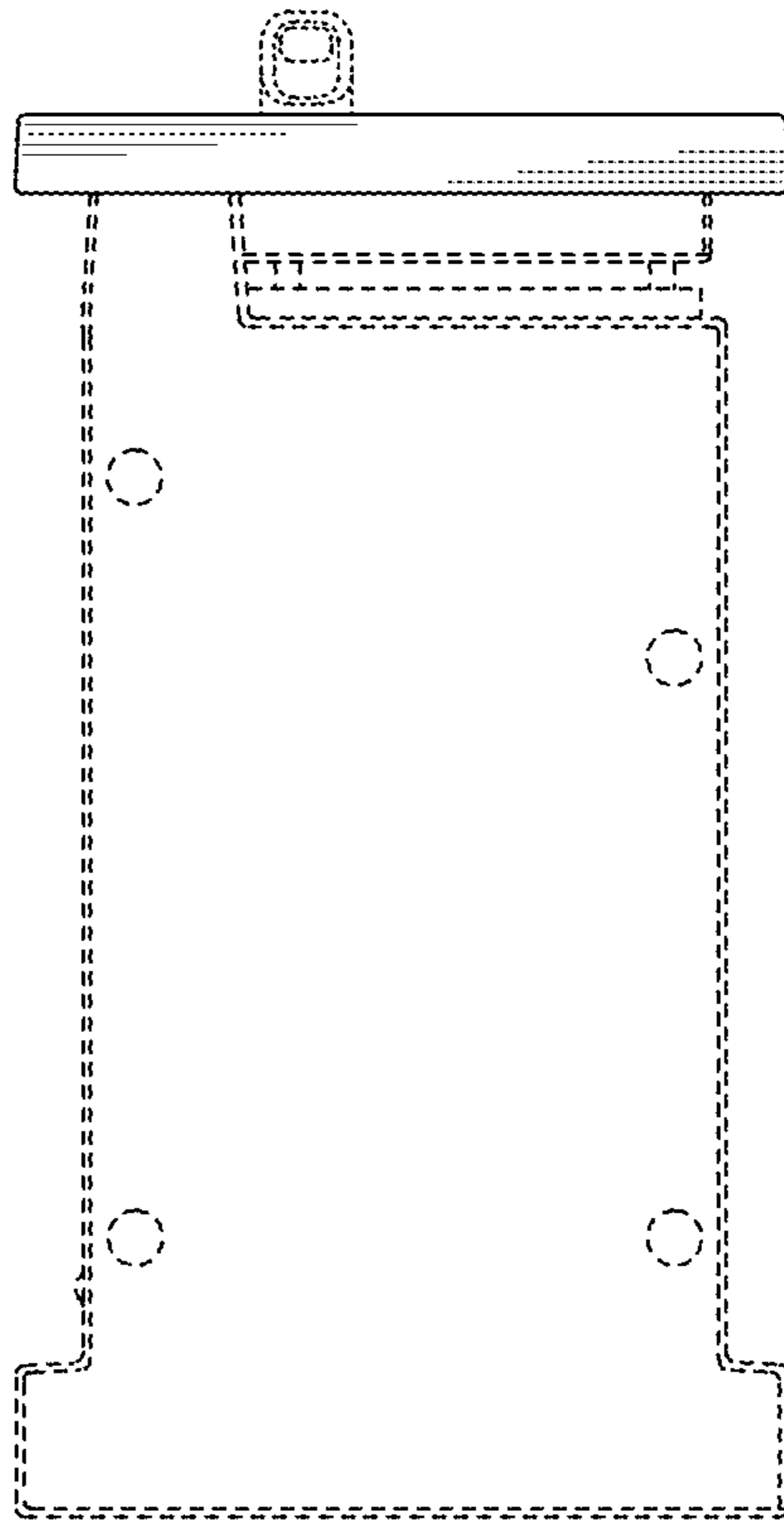

FIG. 31

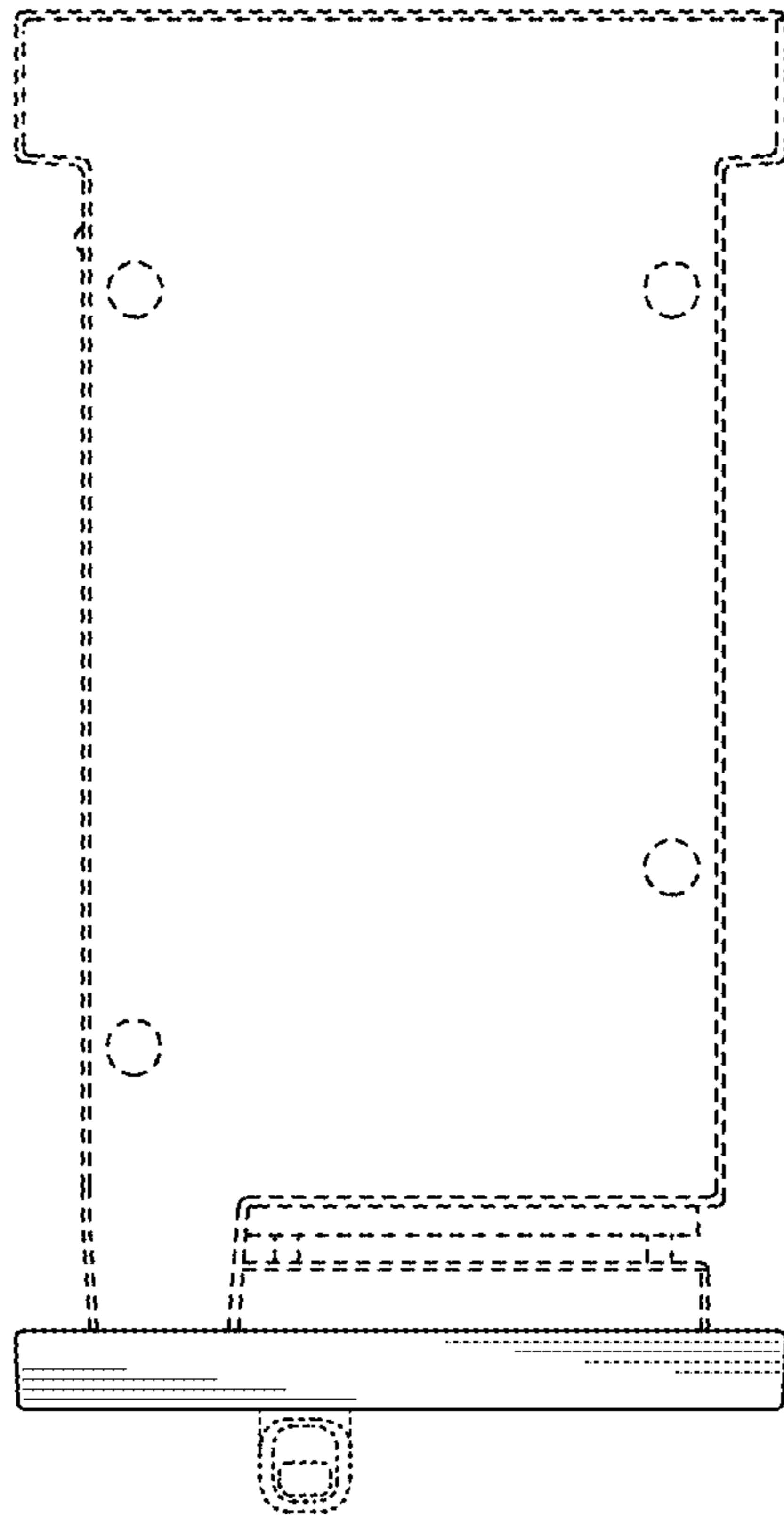

FIG. 32