



US00D974350S

(12) **United States Design Patent** (10) **Patent No.:** **US D974,350 S**
Lim (45) **Date of Patent:** **** Jan. 3, 2023**

(54) **LAPTOP COMPUTER**

(71) Applicant: **Lenovo (Beijing) Co., Ltd.**, Beijing (CN)

(72) Inventor: **Ghwang-Hyun Lim**, Beijing (CN)

(73) Assignee: **Lenovo (Beijing) Co., Ltd.**, Beijing (CN)

(**) Term: **15 Years**

(21) Appl. No.: **29/788,105**

(22) Filed: **Mar. 16, 2021**

Related U.S. Application Data

(62) Division of application No. 35/507,695, filed on Jun. 25, 2019 (U.S. filing date under 35 U.S.C. 384), and (Continued)

(30) **Foreign Application Priority Data**

Dec. 25, 2018 (CN) 201830755217.2
Dec. 25, 2018 (CN) 201830755874.7

(51) **LOC (14) Cl.** **14-02**

(52) **U.S. Cl.**
USPC **D14/316**; D14/439

(58) **Field of Classification Search**
USPC D14/300–301, 305–307, 314–328, 331, D14/333–336, 338–340, 356, 371, D14/373–377, 432–433, 439, 441, D14/447–451, 511, 217, 219–221, 299, D14/345, 352, 440, 132, 134, 138 AB, D14/203.4, 203.8, 224, 224.1, 257; D8/373, 380, 394–395; D18/4.5, 12 (Continued)

(56) **References Cited**

U.S. PATENT DOCUMENTS

D493,785 S 8/2004 Andre
D506,752 S * 6/2005 Huh D14/316
(Continued)

OTHER PUBLICATIONS

Brant, Tom, *Lenovo Yoga 920 Review*, posted at PC Mag, posting date Oct. 20, 2017. Site visited Apr. 22, 2022. URL: <<https://www.pcmag.com/reviews/lenovo-yoga-920>> (Year: 2017).* (Continued)

Primary Examiner — Kathleen L Jones
(74) *Attorney, Agent, or Firm* — Oppedahl Patent Law Firm LLC

(57) **CLAIM**

The ornamental design for a laptop computer, as shown and described.

DESCRIPTION

FIG. 1 is a front view of a laptop computer showing the new design;
FIG. 2 is a back view thereof;
FIG. 3 is a left side view thereof;
FIG. 4 is a partial enlarged view of FIG. 3;
FIG. 5 is a right side view thereof;
FIG. 6 is a top view thereof;
FIG. 7 is a bottom view thereof;
FIG. 8 is a partial enlarged view of FIG. 5; and,
FIG. 9 is a partial enlarged view of FIG. 7.
The broken lines shown in the drawings illustrate portions of the laptop computer that form no part of the claimed design. The dot-dash broken lines shown in the drawings indicate the outer limits of portions of figures shown enlarged and form no part of the claimed design. The dot dot dash broken lines illustrate the boundary of the claimed design and form no part thereof.

1 Claim, 7 Drawing Sheets

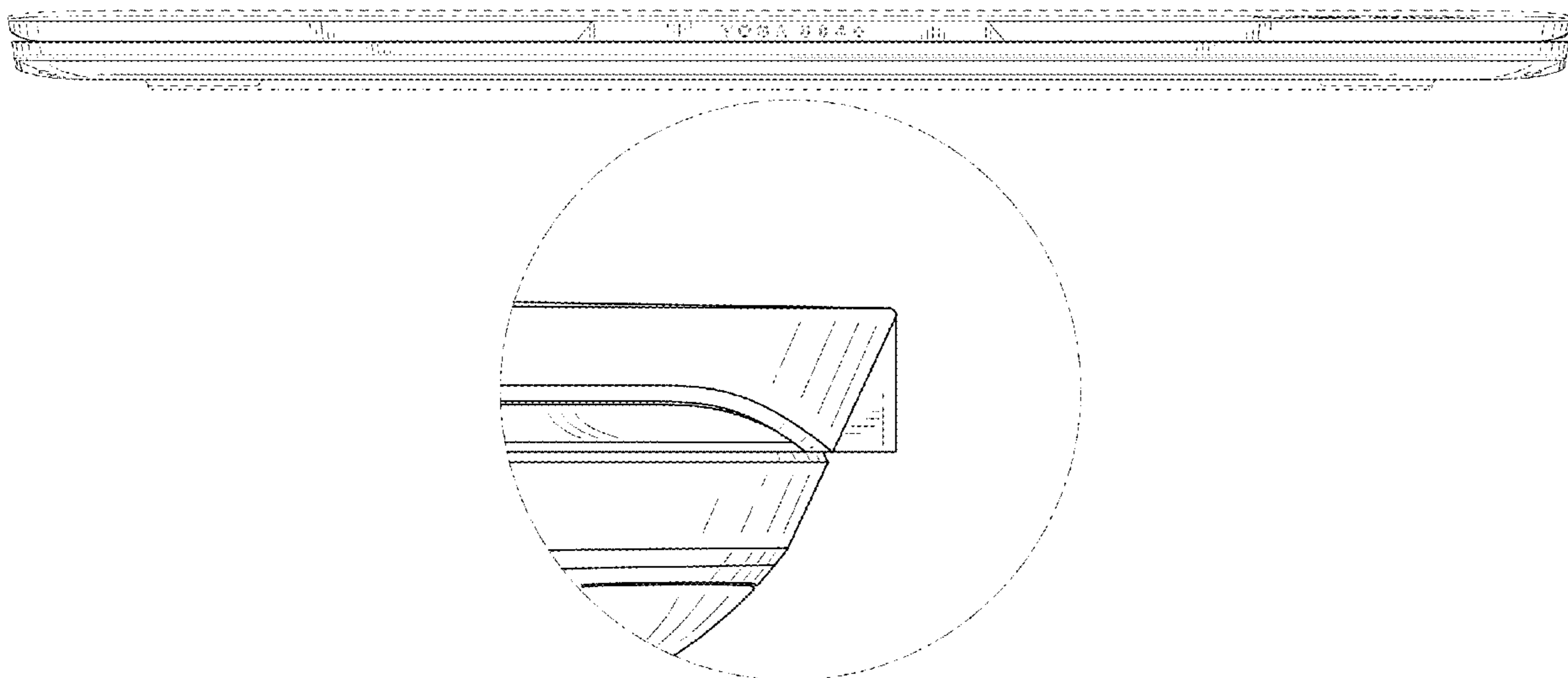

Related U.S. Application Data

having an international filing date of Jun. 25, 2019, now Pat. No. Des. 914,669.

(58) **Field of Classification Search**

CPC G06F 1/16; G06F 1/1681; G06F 1/1601; G06F 1/1607; G06F 1/1613; G06F 1/1616; G06F 1/1628; G06F 1/163; G06F 1/1633; G06F 1/1656; G06F 1/1662; G06F 1/1667; G06F 1/1666; H05K 5/00; H05K 5/0004; H05K 5/0226; H05K 5/023; H05K 5/0234; H05K 5/0239; H05K 5/0243

See application file for complete search history.

(56) **References Cited**

U.S. PATENT DOCUMENTS

D558,752 S 1/2008 Andre
 D571,364 S 6/2008 Andre
 D572,247 S 7/2008 Andre
 D581,411 S 11/2008 Kumano
 D589,507 S 3/2009 Andre
 D604,294 S 11/2009 Andre
 D611,469 S 3/2010 Andre
 D613,284 S 4/2010 Solomon
 D613,734 S * 4/2010 Sun D14/315
 D616,881 S 6/2010 Andre
 D625,717 S 10/2010 Andre
 D629,797 S * 12/2010 Chu D14/327
 D661,693 S 6/2012 Andre
 D682,820 S * 5/2013 McManigal D14/315
 D701,200 S * 3/2014 Chen D14/318
 D701,858 S * 4/2014 Hyounghshin D14/315
 D714,284 S * 9/2014 Lin D14/315
 D715,289 S 10/2014 Heck et al.
 8,947,874 B2 2/2015 Andre
 D751,543 S * 3/2016 Chon D14/315
 D753,645 S 4/2016 Tian et al.
 D768,620 S * 10/2016 Wang D14/315

D770,442 S * 11/2016 Tu D14/315
 D781,282 S * 3/2017 Hsu D14/315
 D786,857 S 5/2017 Tian et al.
 D802,584 S * 11/2017 Kong D14/315
 D803,825 S 11/2017 Akana et al.
 D806,701 S 1/2018 Akana et al.
 D813,859 S * 3/2018 Oakley D14/315
 D816,661 S 5/2018 Akana et al.
 D825,552 S 8/2018 Andre et al.
 D835,095 S * 12/2018 Goh D14/315
 D874,457 S 2/2020 Oakley
 D888,708 S 6/2020 Akana et al.
 D890,168 S 7/2020 Akana et al.
 D890,749 S * 7/2020 Draca D14/327
 D898,733 S * 10/2020 Zhang D14/315
 D914,669 S * 3/2021 Lim D14/315
 D915,396 S * 4/2021 Sheu D14/327
 D917,456 S * 4/2021 Hsieh D14/315
 D936,646 S * 11/2021 Lin D14/327
 D952,628 S * 5/2022 DiLoreto D14/327
 D953,321 S * 5/2022 Hsu D14/315
 2005/0063150 A1 * 3/2005 Nakatani G06F 1/162
 361/679.21
 2010/0091442 A1 4/2010 Theobald
 2011/0075356 A1 * 3/2011 Tanaka H01Q 1/38
 361/679.55

OTHER PUBLICATIONS

Elliott, Matt, Lenovo Yoga 9i review: This premium 2-in-1 laptop keeps going and going, posted at PCWorld, posting date Feb. 3, 2022. Site visited Apr. 22, 2022. URL: <<https://www.pcworld.com/article/611108/lenovo-yoga-9i-review.html>> (Year: 2022).
 Screenshot @ minute 4:27 of video: YouTube: Review: Apple's Late-2016 MacBook Pro with Touch Bar. Nov. 14, 2016; one page. Found online Sep. 3, 2020 at <https://www.youtube.com/watch?v=-FYELMBSPPE> (Year: 2016).
 Notice of Restriction Requirement of the U.S. Appl. No. 35/507,695, dated Sep. 18, 2020.

* cited by examiner

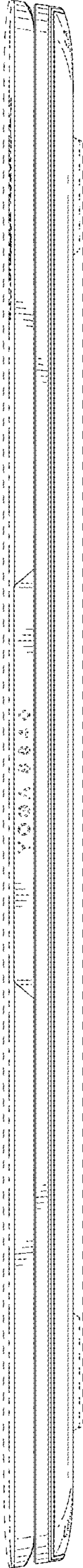

FIG. 1

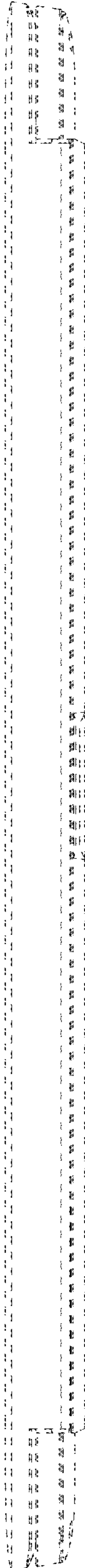
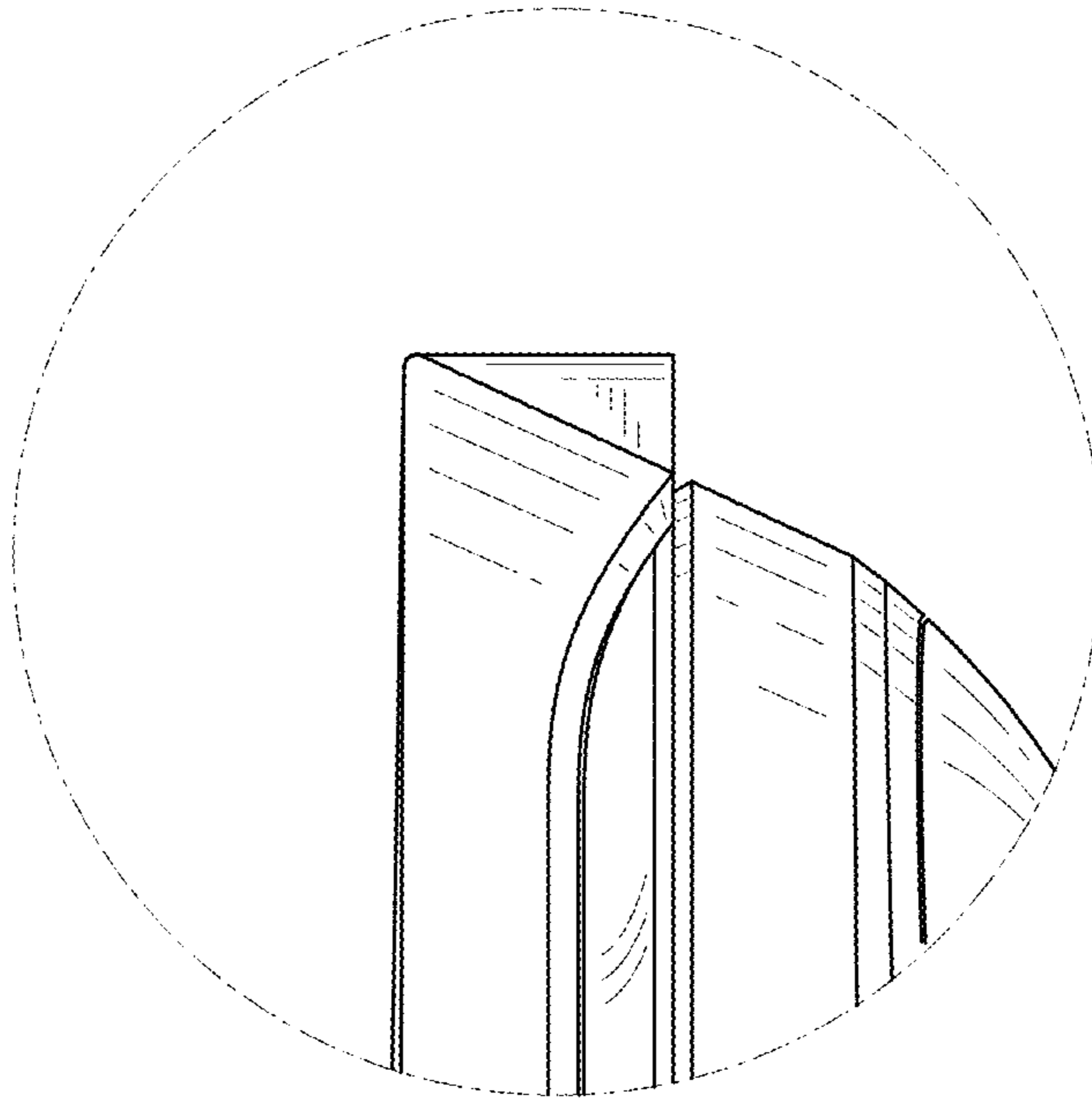
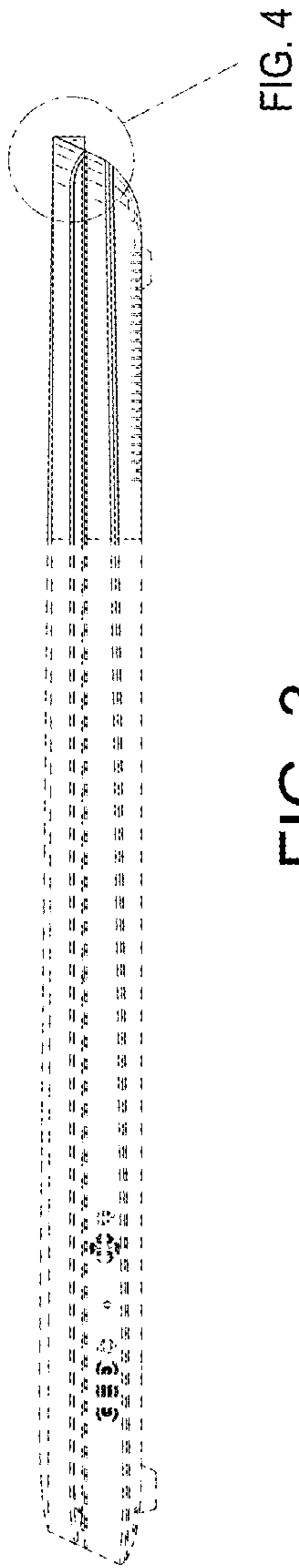

FIG. 2



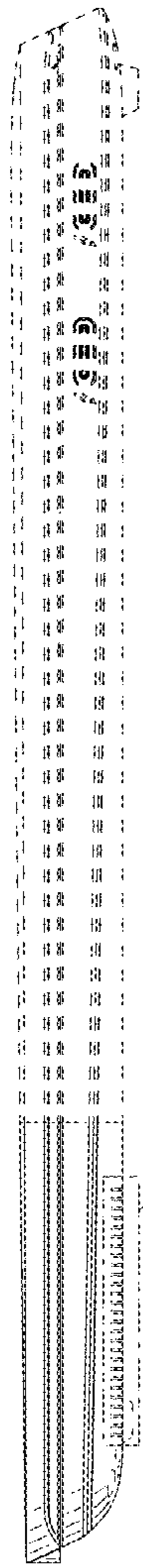

FIG. 8

FIG. 5

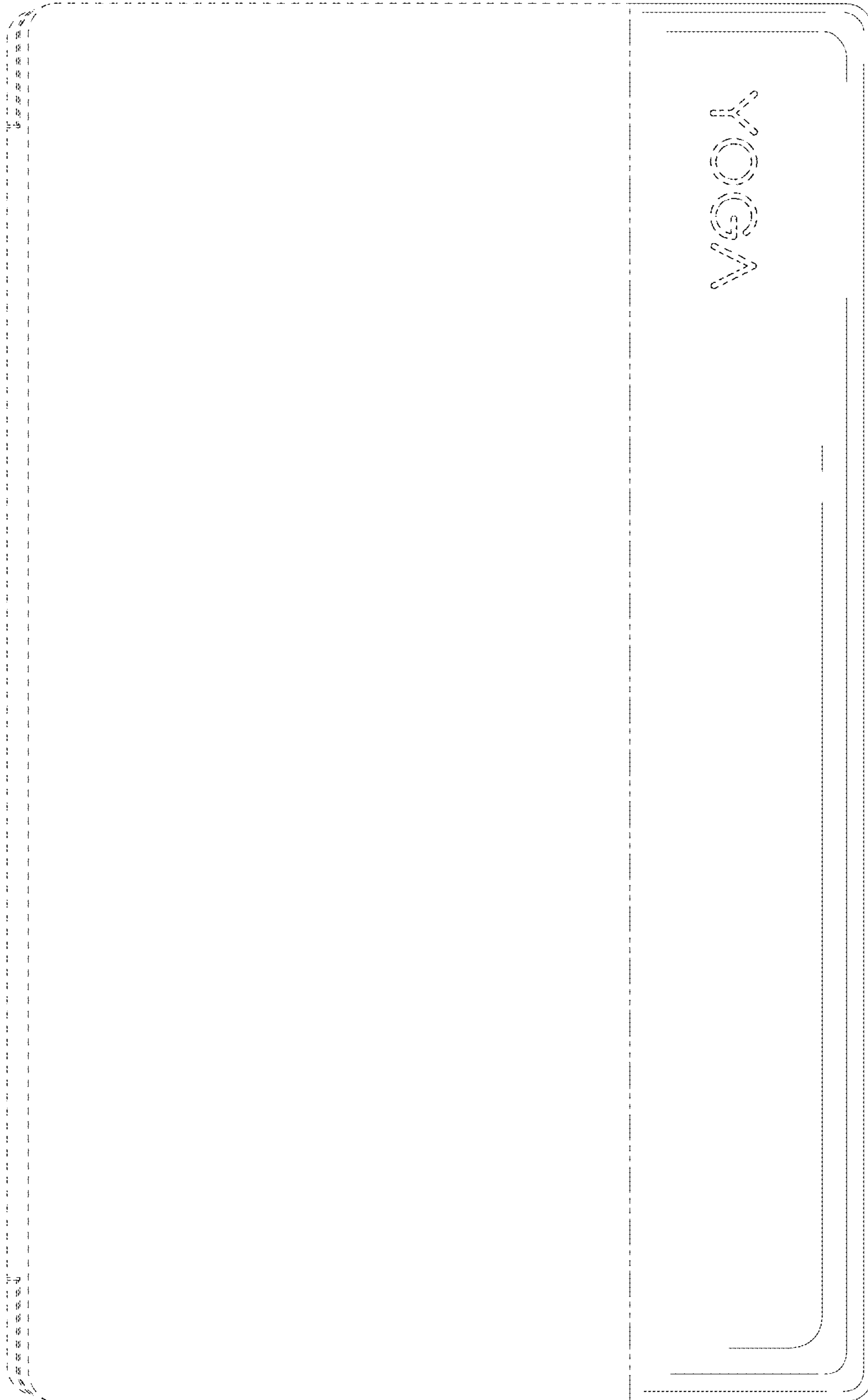

FIG. 6

FIG. 9

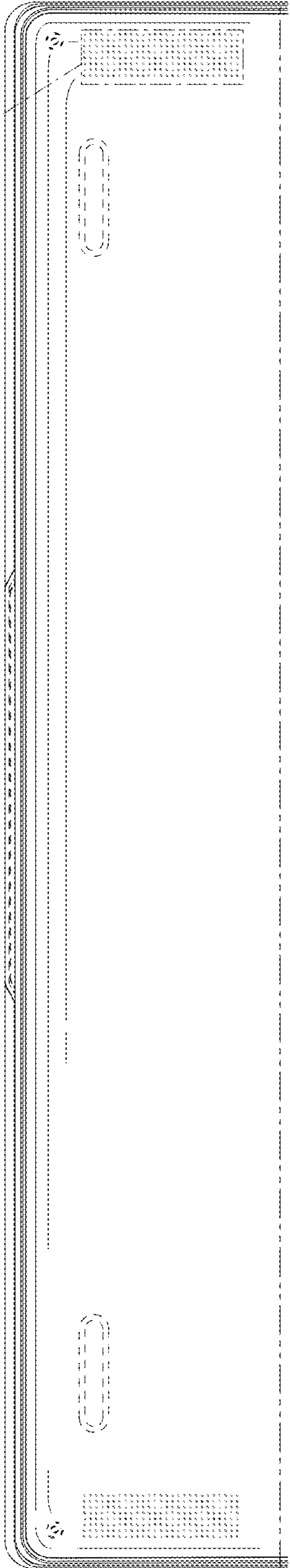

FIG. 7

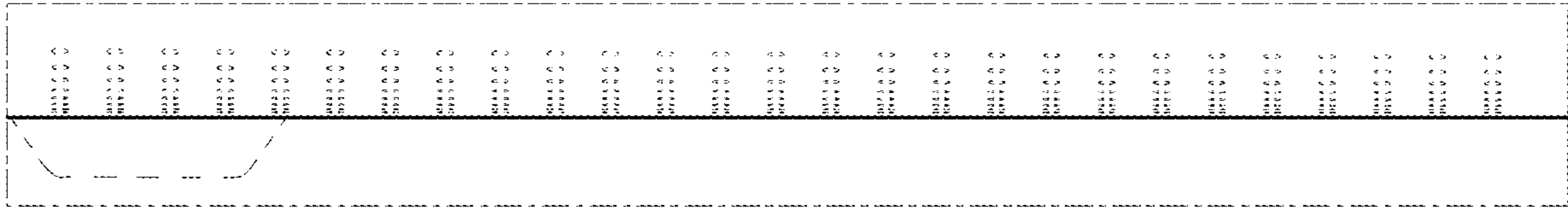

FIG. 8



FIG. 9