



US00D974279S

(12) **United States Design Patent**
Su

(10) **Patent No.:** **US D974,279 S**
(45) **Date of Patent:** **** Jan. 3, 2023**

(54) **CAR CONSOLE ORGANIZER**
(71) Applicant: **Zhanglin Su**, Huazhou (CN)
(72) Inventor: **Zhanglin Su**, Huazhou (CN)
(73) Assignee: **Zhanglin Su**, Huazhou (CN)
(**) Term: **15 Years**

D940,057 S *	1/2022	Guo	D12/425
D946,493 S *	3/2022	Huang	D12/425
D949,773 S *	4/2022	Huang	D12/425
D950,476 S *	5/2022	Gan	D12/425
D955,323 S *	6/2022	Reid	D12/425
D960,076 S *	8/2022	Pan	D12/425
D960,077 S *	8/2022	Pan	D12/425
D961,493 S *	8/2022	Ma	D12/425
D964,258 S *	9/2022	Tian	D12/425
D964,259 S *	9/2022	Tian	D12/425
D964,914 S *	9/2022	Wei	D12/425

(21) Appl. No.: **29/854,778**

* cited by examiner

(22) Filed: **Sep. 28, 2022**

Primary Examiner — Katrina A Betton

(30) **Foreign Application Priority Data**

(74) *Attorney, Agent, or Firm* — Nitin Kaushik

Sep. 23, 2022 (CN) 202230630411.4

(51) **LOC (14) Cl.** **12-16**

(52) **U.S. Cl.**
USPC **D12/425**

(58) **Field of Classification Search**
USPC D12/425, 400, 406, 415-420, 424, 426
CPC B60R 16/04; B63B 17/00; B63B 35/00;
B63B 7/085; B63B 25/00
See application file for complete search history.

(57) **CLAIM**

The ornamental design for a car console organizer, as shown and described.

(56) **References Cited**

DESCRIPTION

U.S. PATENT DOCUMENTS

FIG. 1 is a front perspective view of a car console organizer, showing my new design;
FIG. 2 is a rear perspective view thereof;
FIG. 3 is a front view thereof;
FIG. 4 is a rear view thereof;
FIG. 5 is a left side view thereof;
FIG. 6 is a right side view thereof;
FIG. 7 is a top view thereof; and,
FIG. 8 is a bottom view thereof.

D912,608 S * 3/2021 Chen D12/425
D935,381 S * 11/2021 Chen D12/425

1 Claim, 8 Drawing Sheets

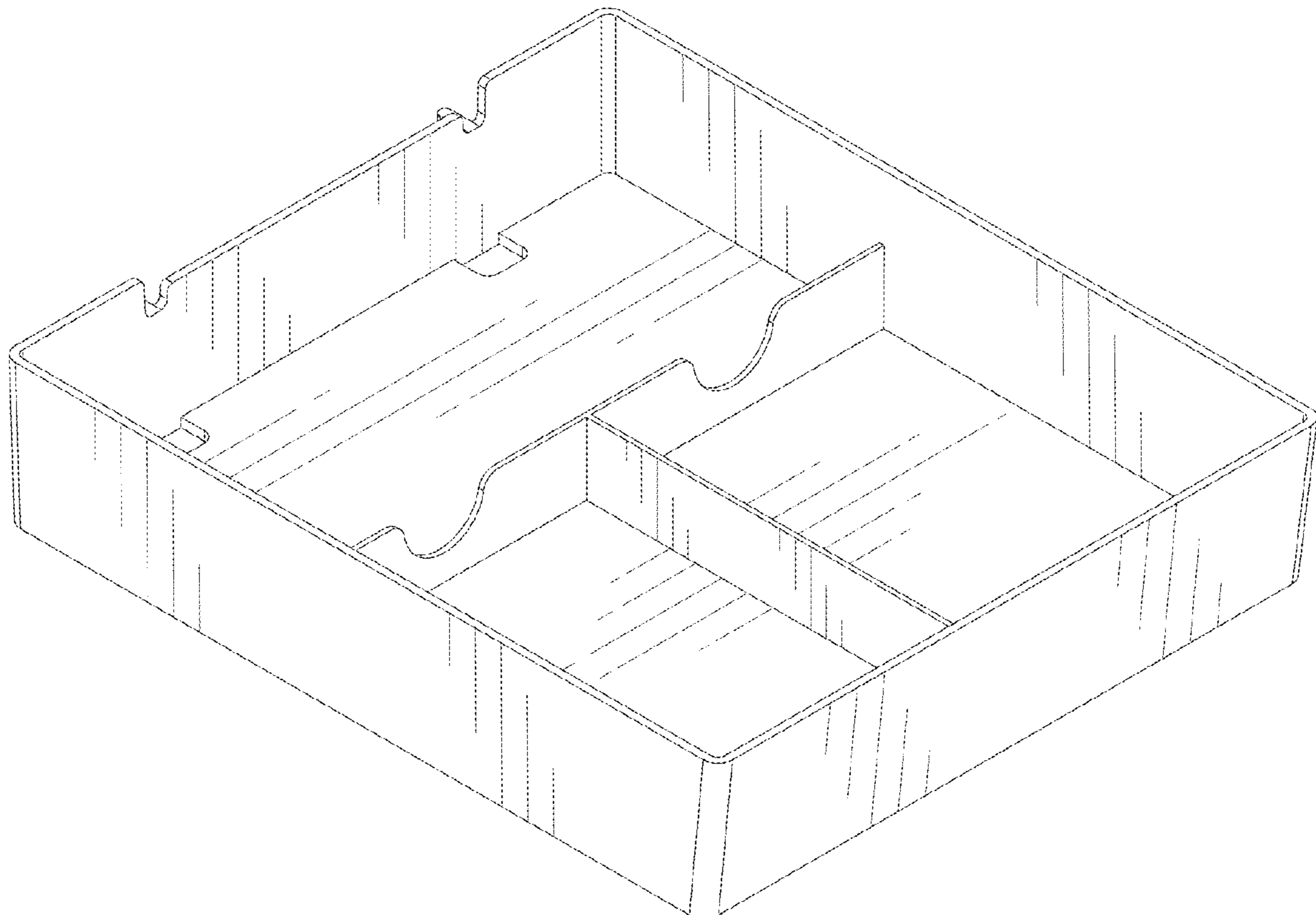

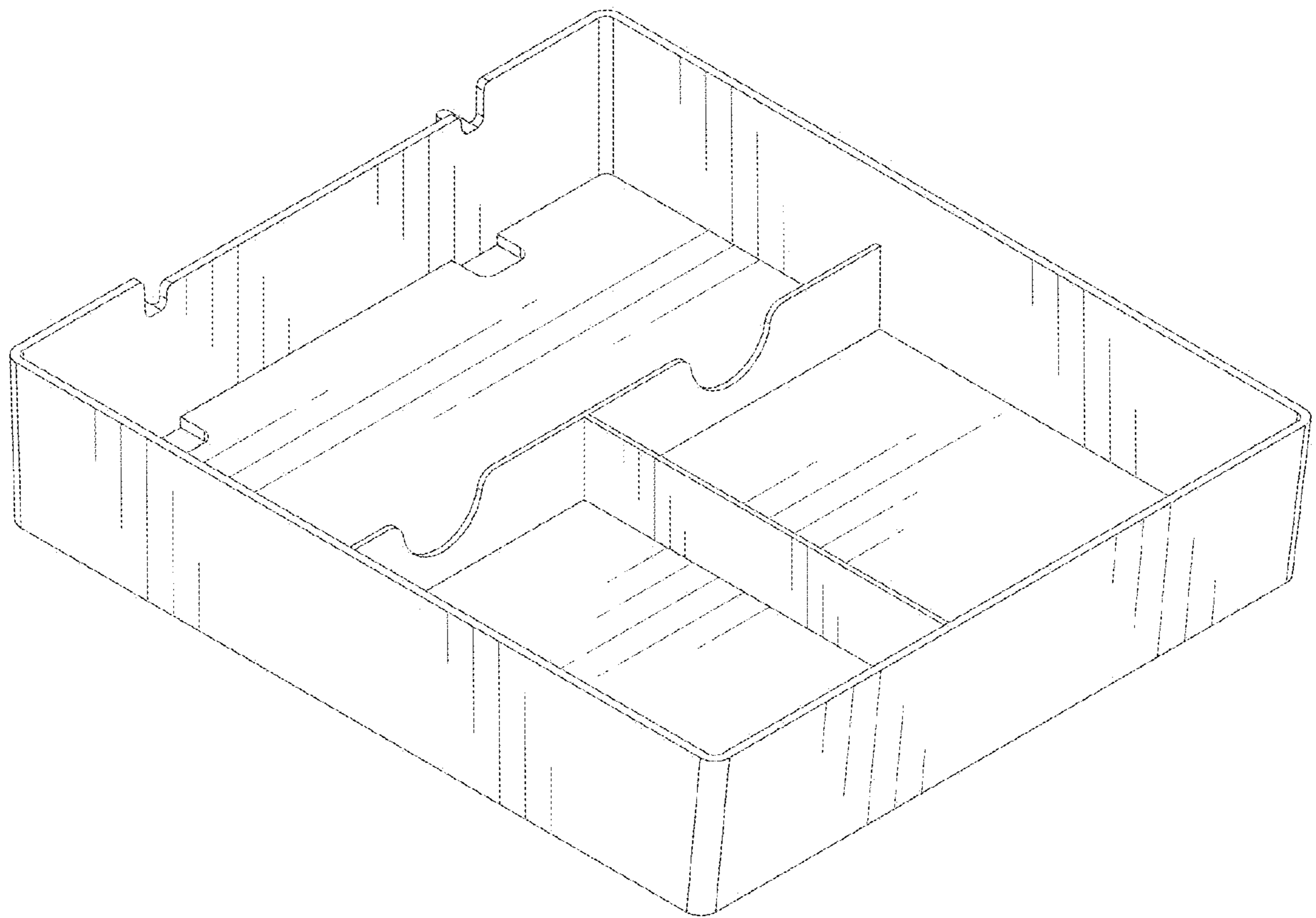

FIG. 1

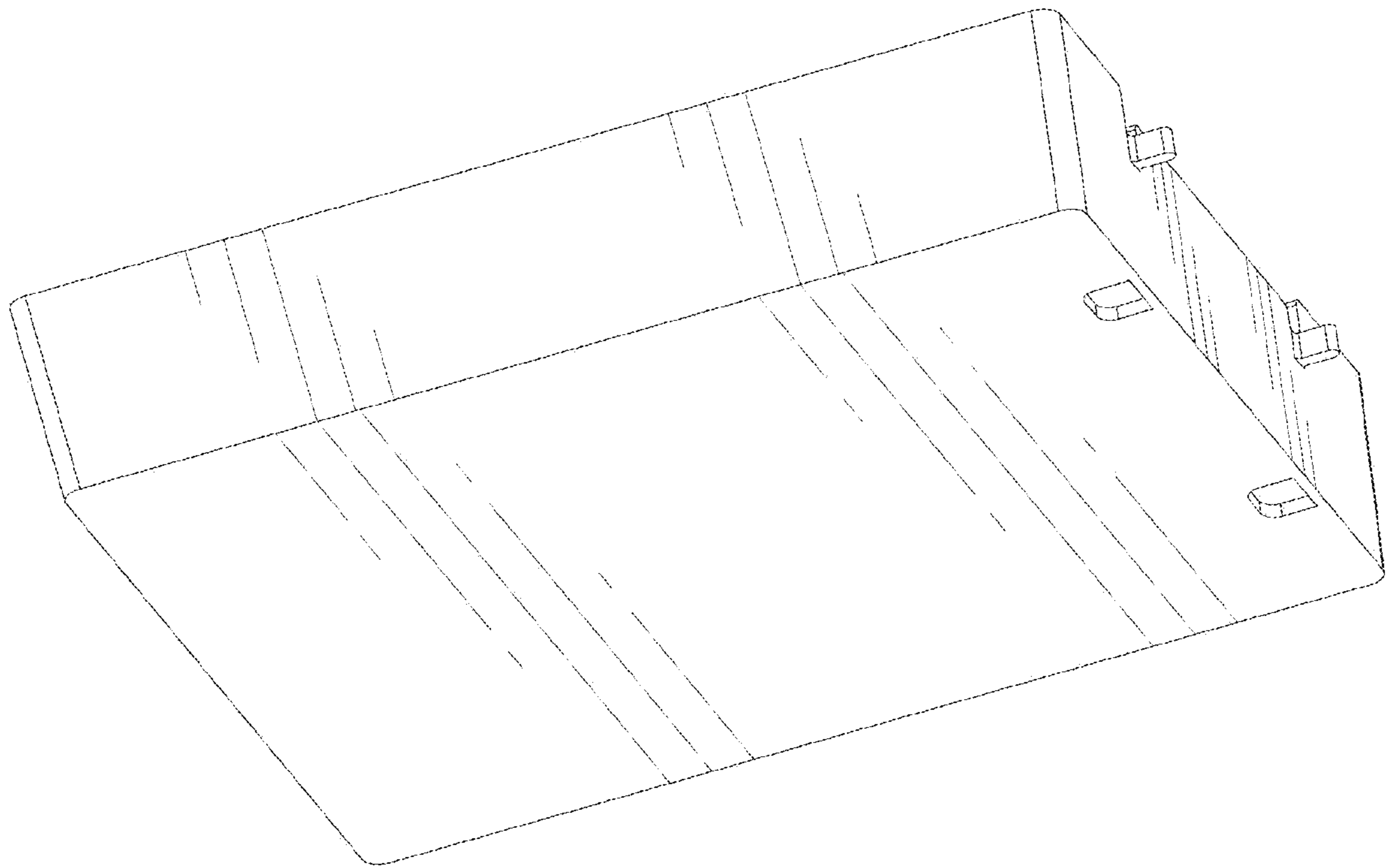

FIG. 2

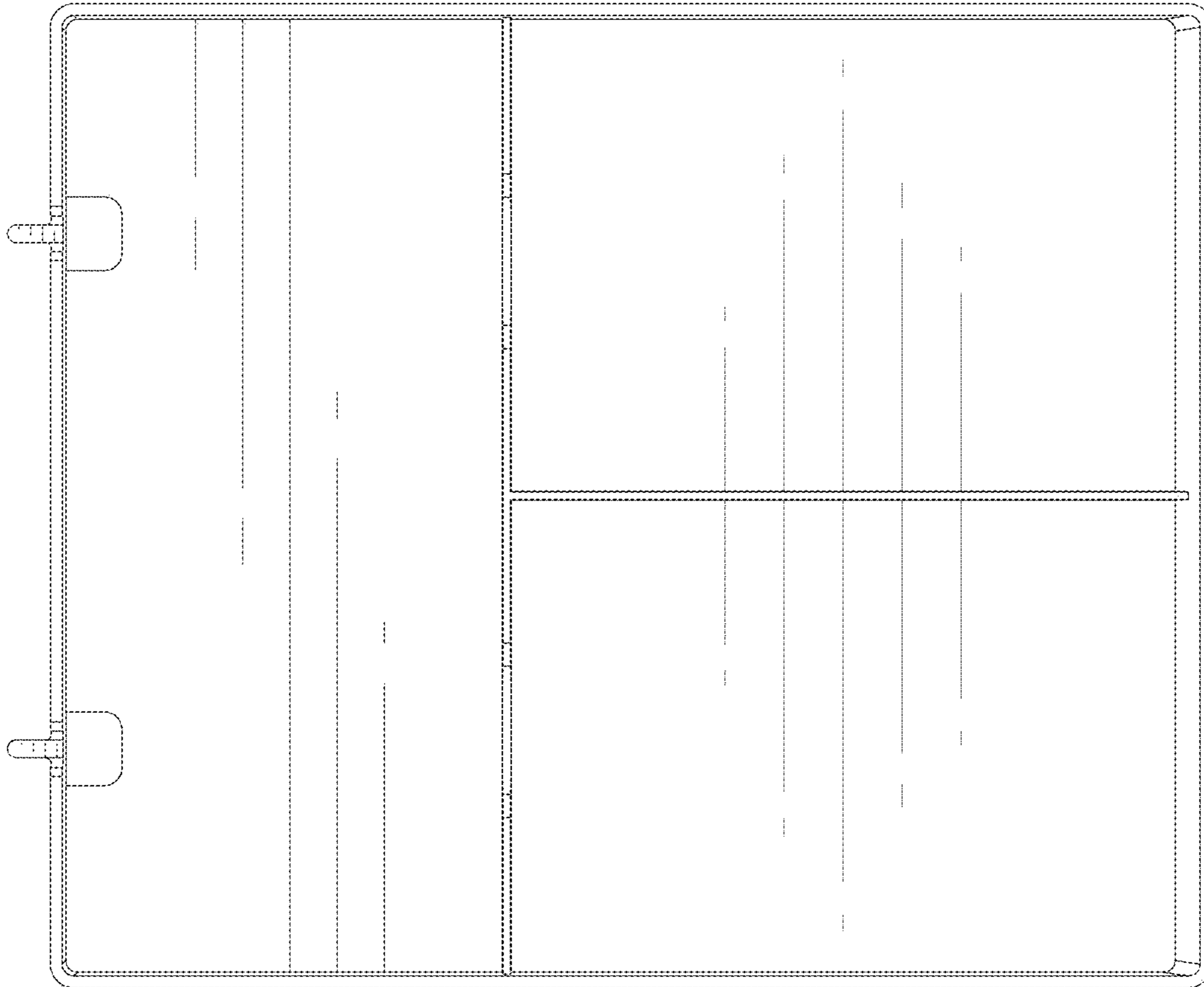

FIG. 3

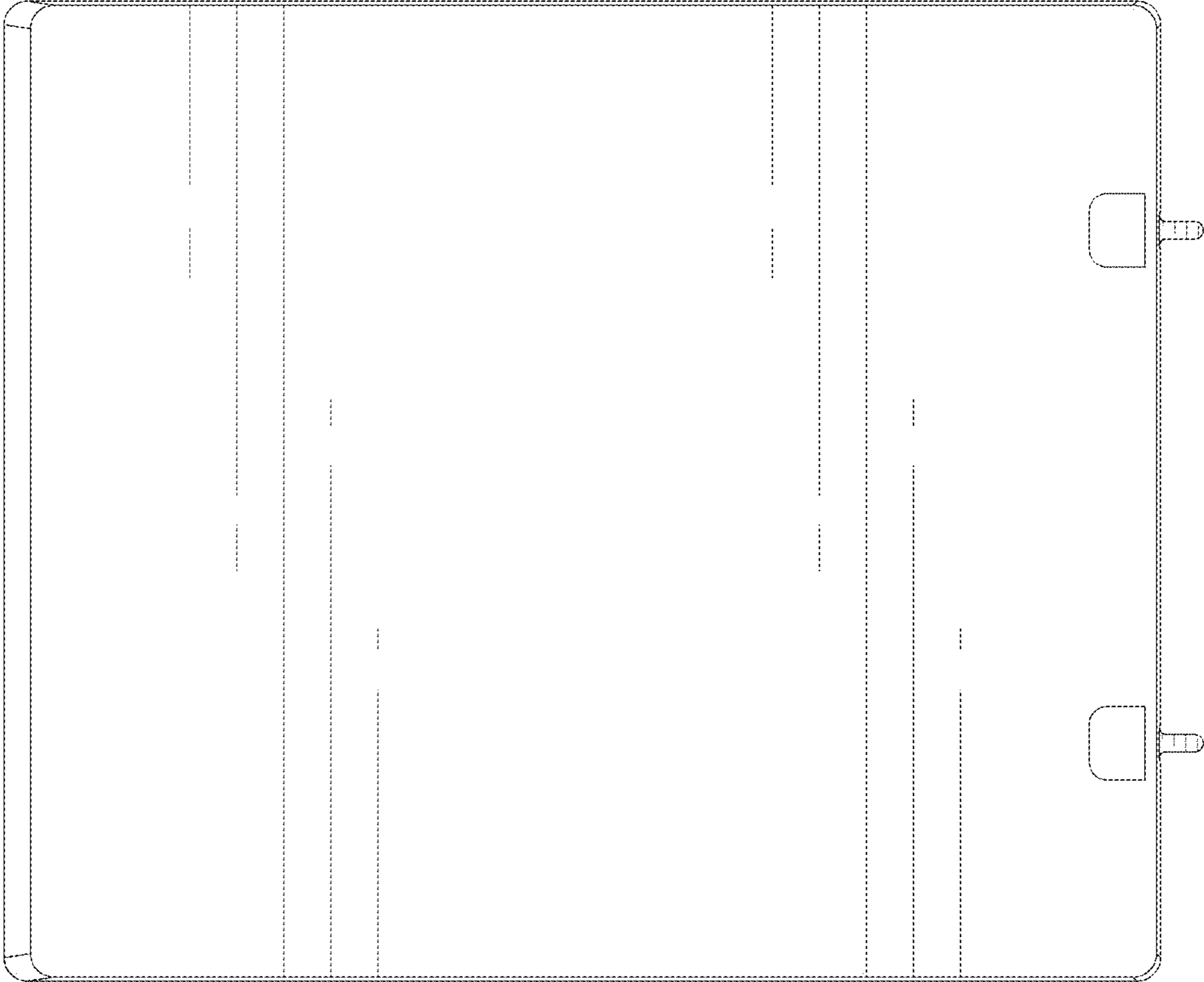

FIG. 4

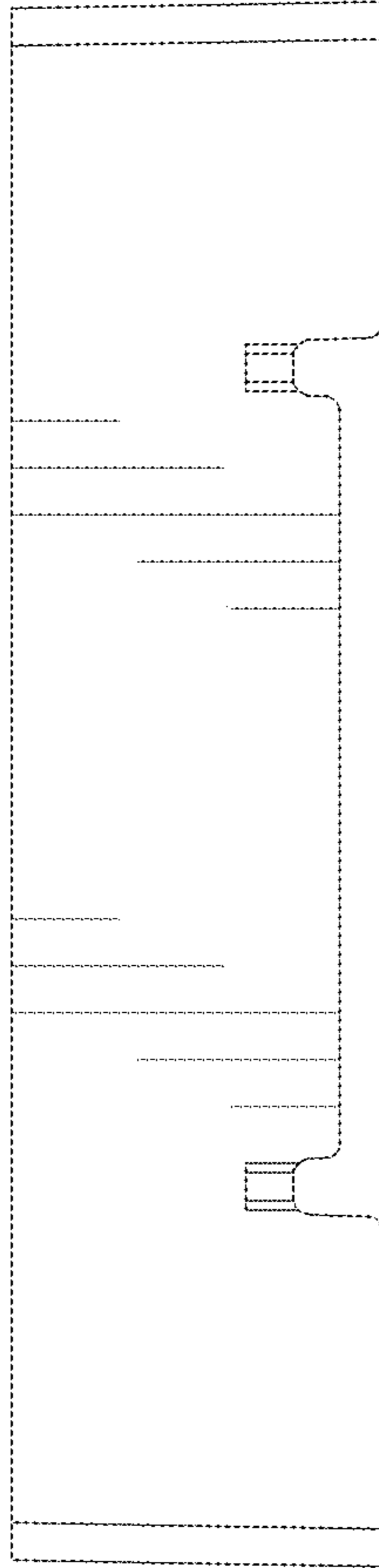

FIG. 5

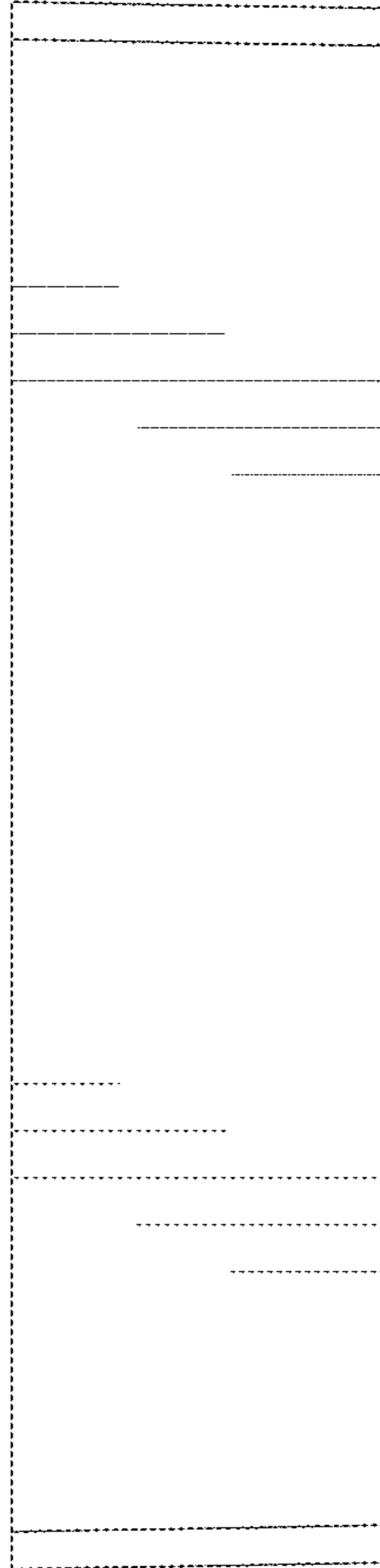

FIG. 6

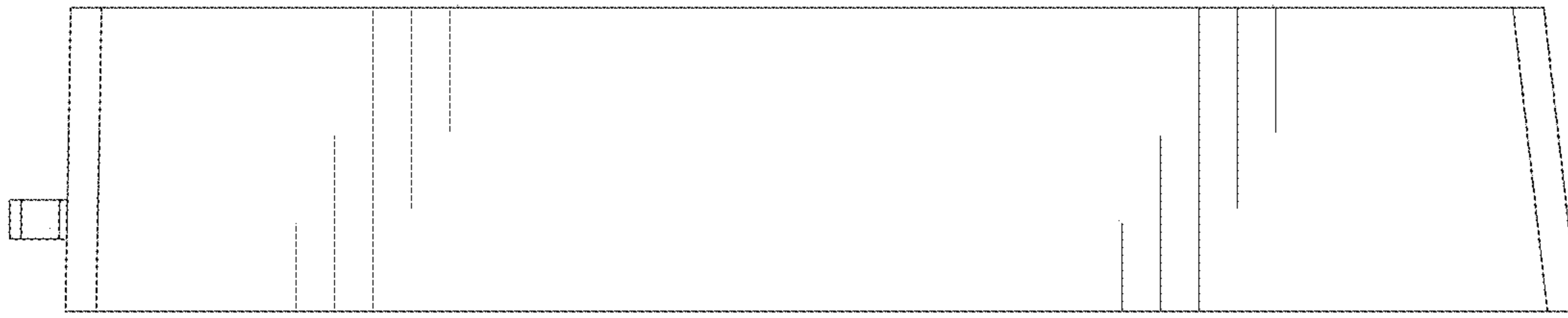

FIG. 7



FIG. 8