



US00D974219S

(12) **United States Design Patent** (10) **Patent No.:** **US D974,219 S**  
**Tashjian** (45) **Date of Patent:** **\*\* Jan. 3, 2023**

(54) **JEWELRY SETTING**

FOREIGN PATENT DOCUMENTS

(71) Applicant: **Venus by Maria Tash, Inc.**, New York, NY (US)

GB 1060194 \* 11/1989  
ID D0000008052-0001 \* 1/2005  
IL 39333 \* 5/2004

(72) Inventor: **Maria Tashjian**, New York, NY (US)

OTHER PUBLICATIONS

(73) Assignee: **Venus by Maria Tash, Inc.**, New York, NY (US)

Beautifully Faceted Cubic Zirconia Teardrops Framed with Halo CZs on Gold Lever Back Earrings pp. 1-11 CJRoseBoutique <https://www.etsy.com/listing/228438868/beautifully-faceted-cubic-zirconia?gpla=1&gao=1&> (Year: 2022).\*

(\*\*) Term: **15 Years**

(Continued)

(21) Appl. No.: **29/749,564**

(22) Filed: **Sep. 7, 2020**

*Primary Examiner* — Kevin K Rudzinski

(51) **LOC (14) Cl.** ..... **11-01**

*Assistant Examiner* — Evans David Delesline

(52) **U.S. Cl.**

(74) *Attorney, Agent, or Firm* — Dentons US LLP

USPC ..... **D11/91; D11/121**

(57) **CLAIM**

(58) **Field of Classification Search**

An ornamental design for a jewelry setting, as shown and described.

USPC ..... D11/89–92, 121; D10/128

CPC ..... A44C 7/00; A44C 7/002; A44C 7/003

See application file for complete search history.

**DESCRIPTION**

(56) **References Cited**

FIG. 1 is a frontal view of a jewelry setting showing a first embodiment;

U.S. PATENT DOCUMENTS

FIG. 2 is a back view thereof;

D58,323 S *	7/1921	Heller	.....	D11/90
D58,324 S *	7/1921	Heller	.....	D11/90
D262,200 S *	12/1981	Kirwan	.....	D11/90
D276,143 S *	10/1984	Williams	.....	D11/90
D389,086 S *	1/1998	Rosenberg	.....	D11/90
D399,160 S *	10/1998	Pandel	.....	D10/128
D460,928 S *	7/2002	Rokah	.....	D11/90
D462,922 S *	9/2002	Yuan	.....	D11/90
D485,507 S *	1/2004	Ho	.....	D11/90
D490,340 S *	5/2004	Ho	.....	D11/90
D543,894 S *	6/2007	Akdemir	.....	D11/90
D569,759 S *	5/2008	Akdemir	.....	D11/92
D584,654 S *	1/2009	Granig	.....	D11/90
D610,936 S *	3/2010	Swarovski	.....	D11/89
D618,131 S *	6/2010	Bartl	.....	D11/89
RE42,486 E *	6/2011	Peled	.....	D11/90

FIG. 3 is a top view thereof;

FIG. 4 is a bottom view thereof;

FIG. 5 is a right view thereof;

FIG. 6 is a left view thereof; and

FIG. 7 is a perspective view thereof.

FIG. 8 is a frontal view of a jewelry setting with a stone showing a second embodiment;

FIG. 9 is a back view thereof;

FIG. 10 is a top view thereof;

FIG. 11 is a bottom view thereof;

FIG. 12 is a right view thereof;

FIG. 13 is a left view thereof; and,

FIG. 14 is a perspective view thereof.

(Continued)

**1 Claim, 14 Drawing Sheets**

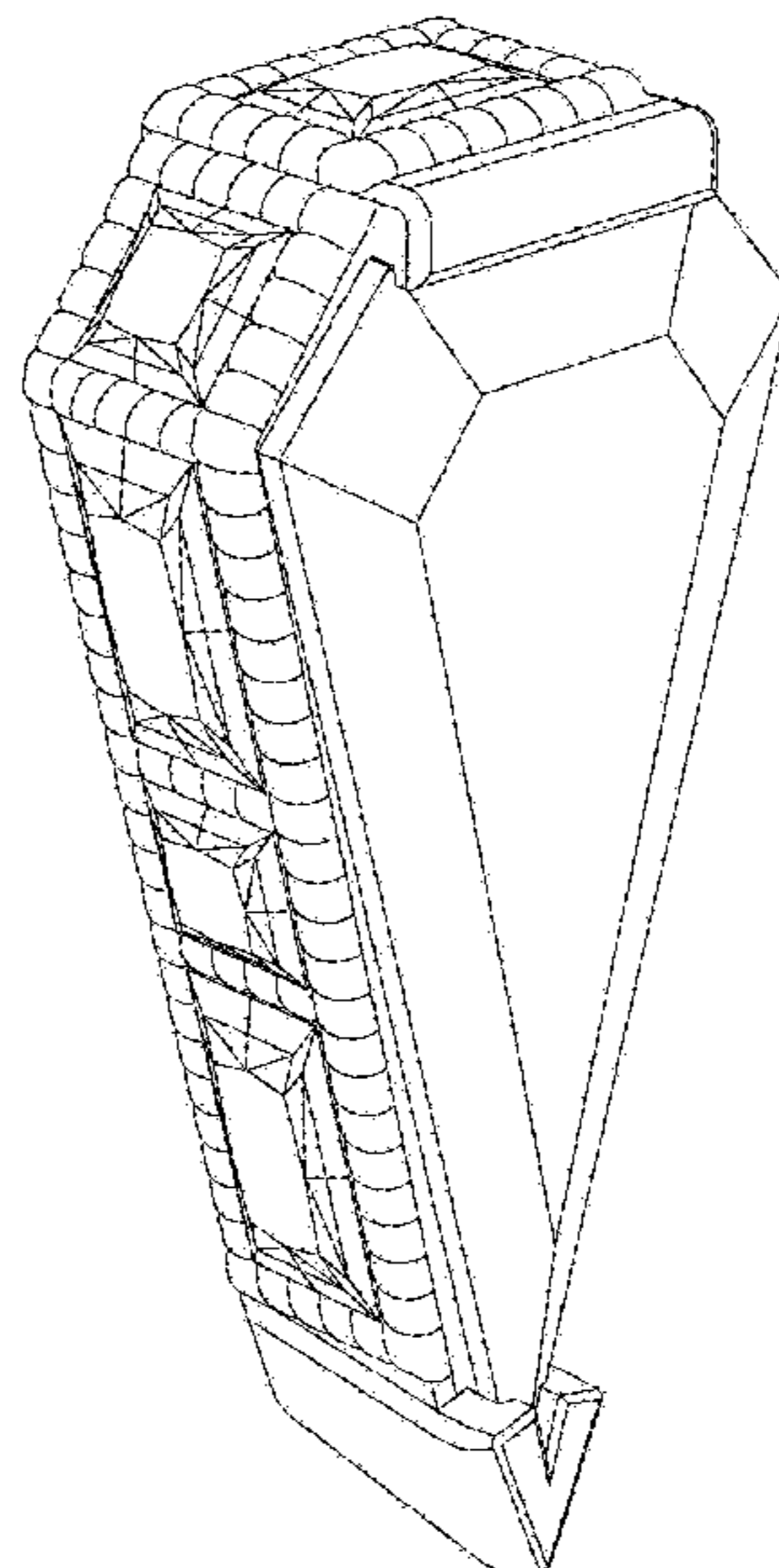

(56)

**References Cited**

U.S. PATENT DOCUMENTS

D799,366 S \* 10/2017 Paz ..... D11/89  
 D893,343 S \* 8/2020 Boozer ..... D11/90

OTHER PUBLICATIONS

Kite Cut Black Onyx Gemstone with Black Spinel Engagement Ring set Vintage Ring 925 Sterling Silver Ring Christmas gift for her pp. 1-21 VintageShineJewels <https://www.etsy.com/listing/1120764934/kite-cut-black-onyx-gemstone-with-black?gpla=1&gao=1&> (Year: 2022).\*

Till Death Do Us Part Rings—Rare Coffin Cut Moissanite 14K White Gold Ring Set pp. 1-5 Black Diamonds New York Evans Naomi <https://www.blackdiamondsnewyork.com/products/till-death-do-us-part-rings-rare-coffin-cut-moissanite-14k-white-gold-ring-set> (Year: 2021).\*

ER Sawyer Jewelers, Hayler Paige Sloane Silhouette Engagement Ring Diamond Band, downloaded from Internet May 2022, <https://www.ersawyer.com/product/sloane-silhouette-engagement-ring-diamond-band/> (3 pages).

Graff, Triple Butterfly Silhouette Diamond Ring, White Gold, downloaded from Internet May 2022, [https://www.graff.com/us-en/jewellery-collections/view-by-collection/butterfly/butterfly-silhouette/triple-butterfly-silhouette-diamond-ring/RGR790\\_RGR790.html](https://www.graff.com/us-en/jewellery-collections/view-by-collection/butterfly/butterfly-silhouette/triple-butterfly-silhouette-diamond-ring/RGR790_RGR790.html) (7 pages).

Hearts On Fire, Sloane Silhouette Engagement Ring, downloaded from Internet May 2022, <https://www.heartsonfire.com/products/rings/sloane-silhouette-engagement-ring/p-8946> (3 pages).

Krikawa, Mokume Diamond Silhouette Engagement Ring, downloaded from Internet May 2022, <https://www.krikawa.com/rings/mokume-diamond-silhouette-engagement-ring> (5 pages).

Scott James, Diamond Mountain Silhouette Setting, downloaded from Internet May 2022, <https://scottjamesjewelry.com/products/diamonds-in-the-rough-setting?variant=31704028020835> (7 pages).

UnEEK, The Silhouette Collection, downloaded from Internet May 2022, <https://www.uneekjewelry.com/collections/silhouette.html> (5 pages).

\* cited by examiner

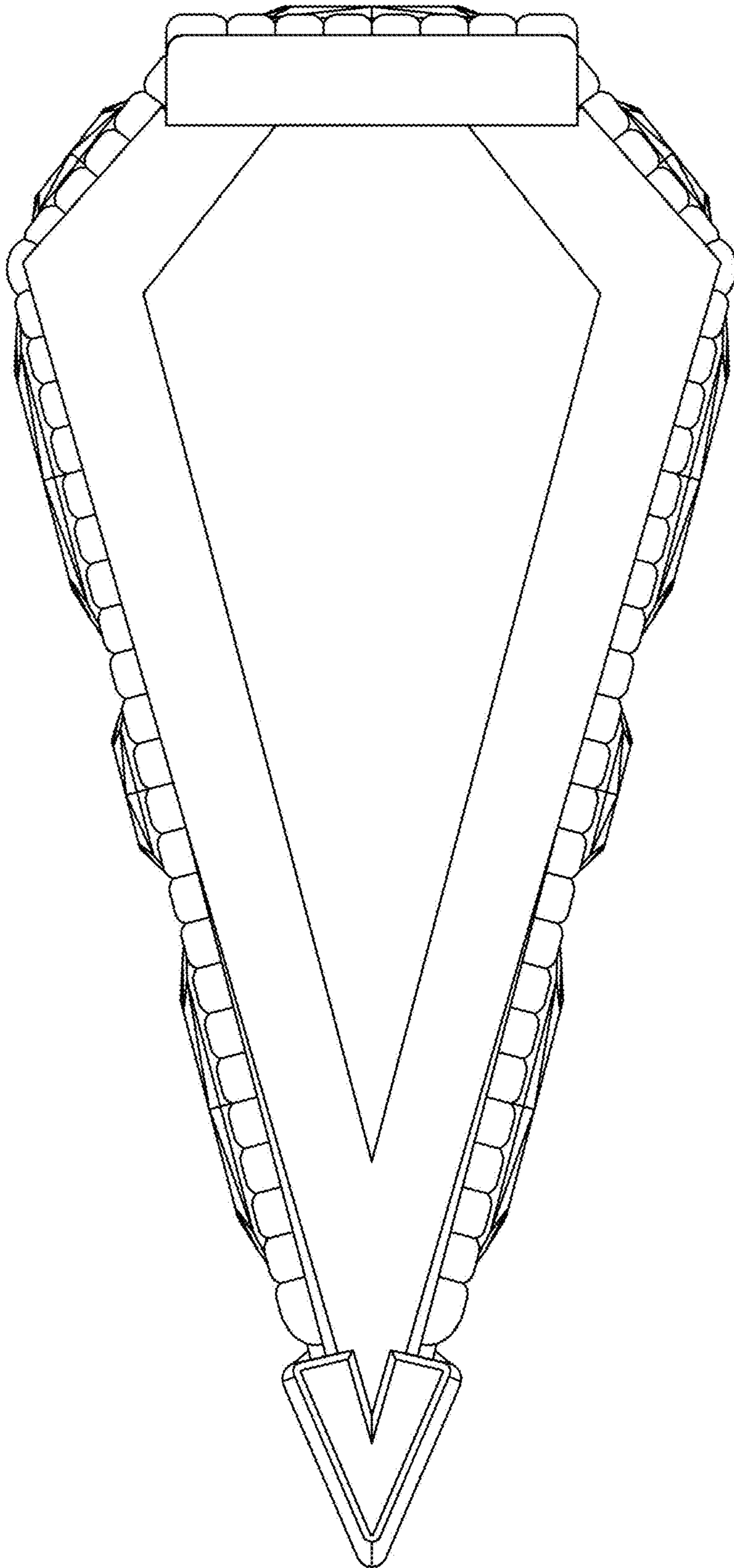

FIGURE 1

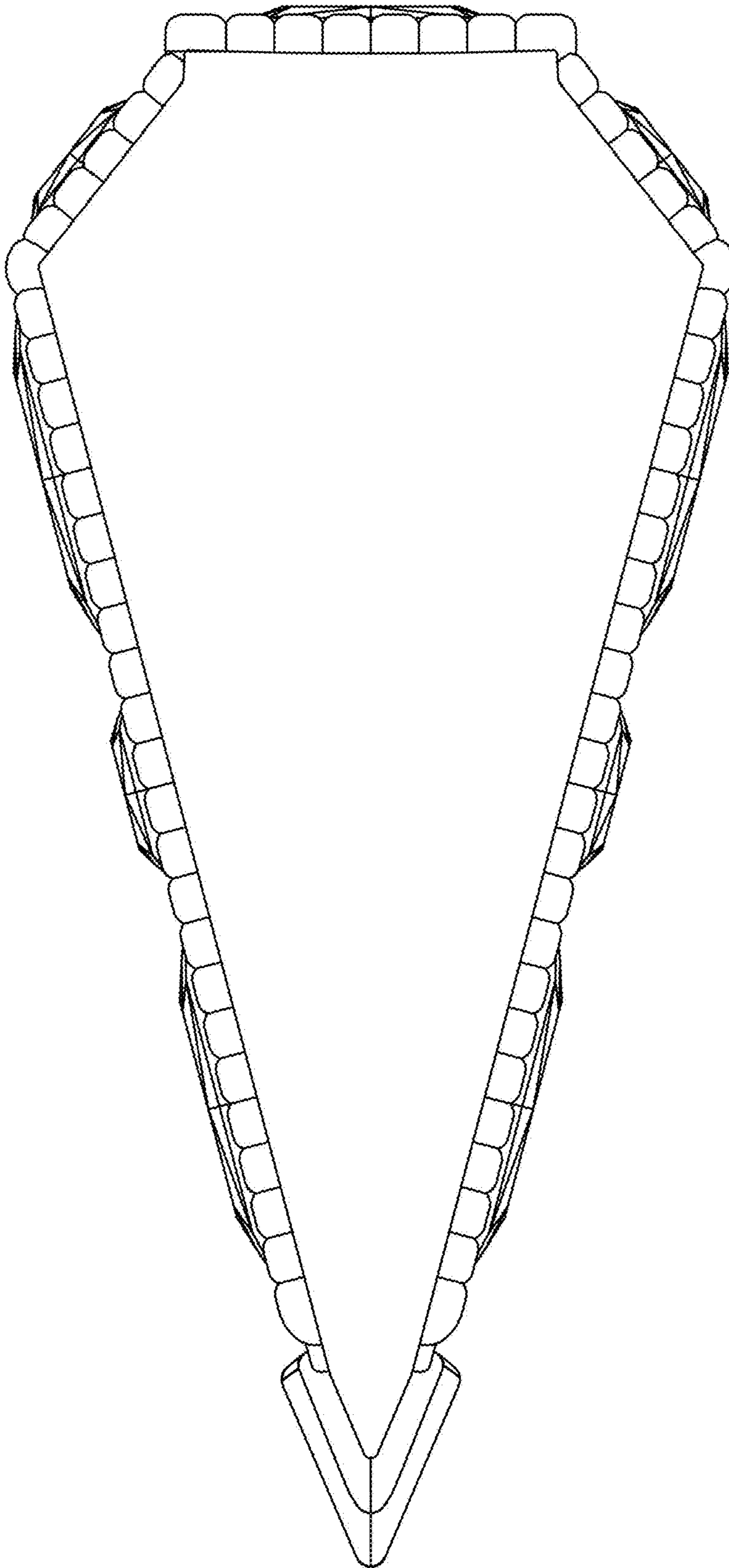

FIGURE 2

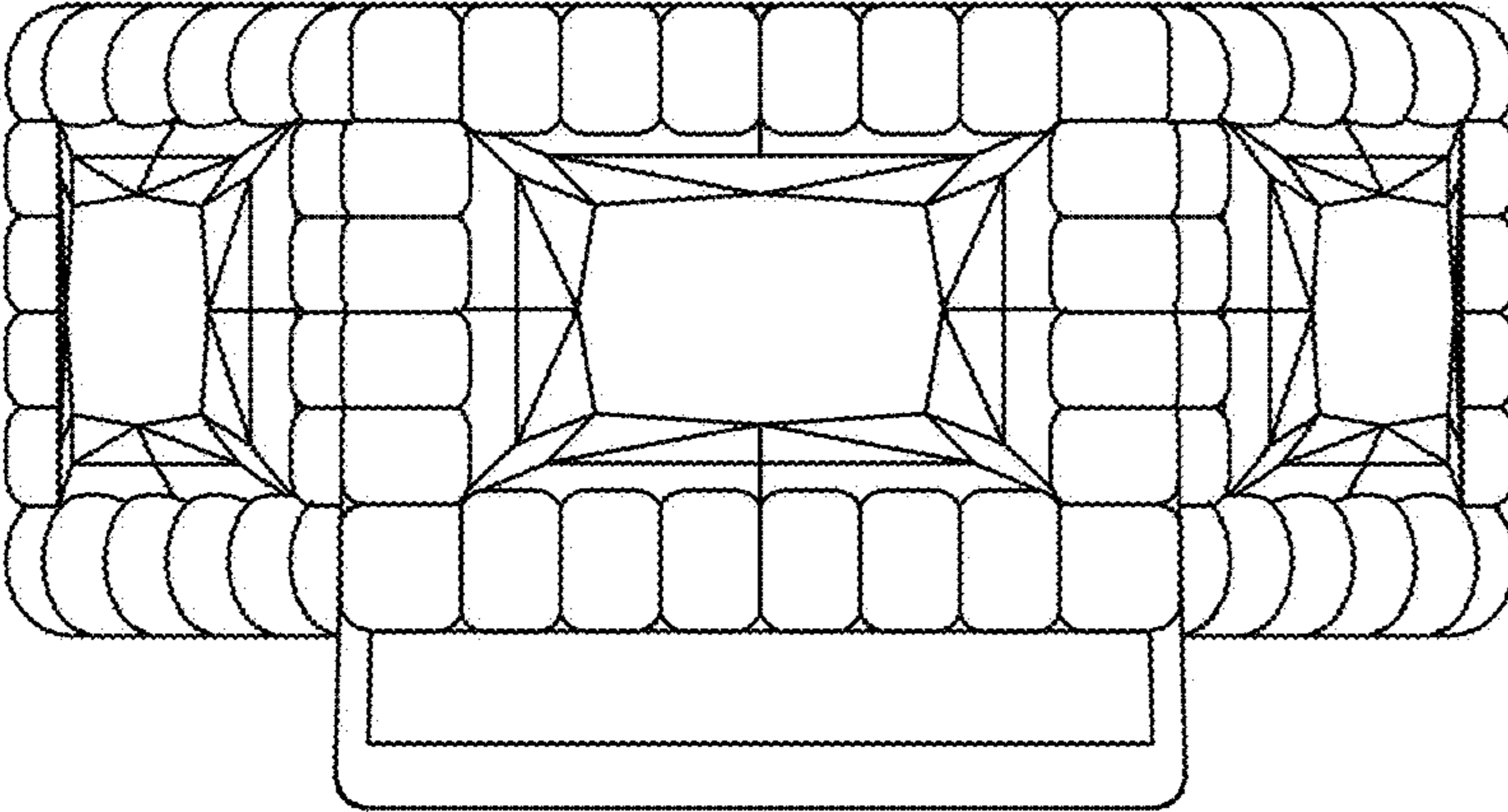

FIGURE 3

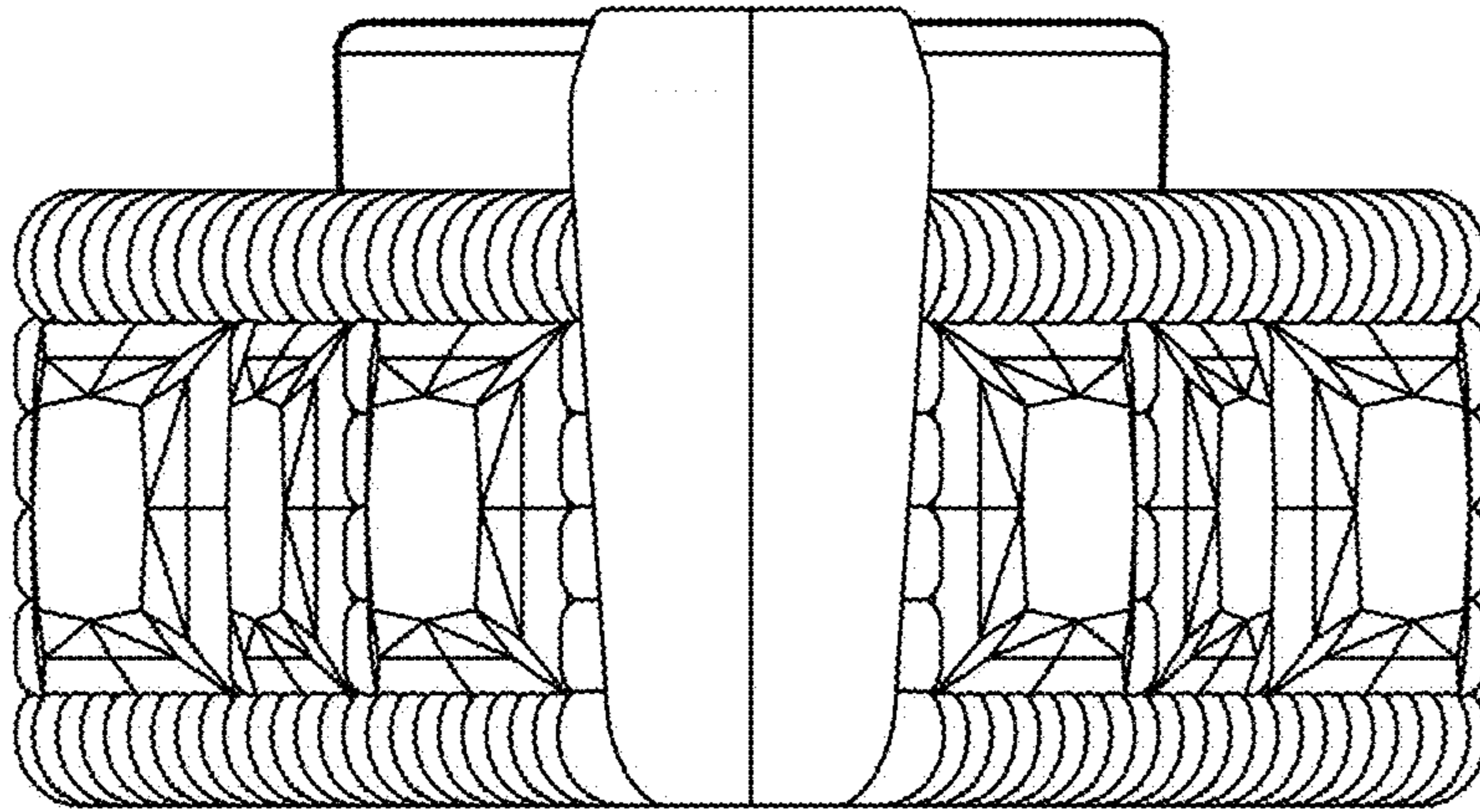

FIGURE 4

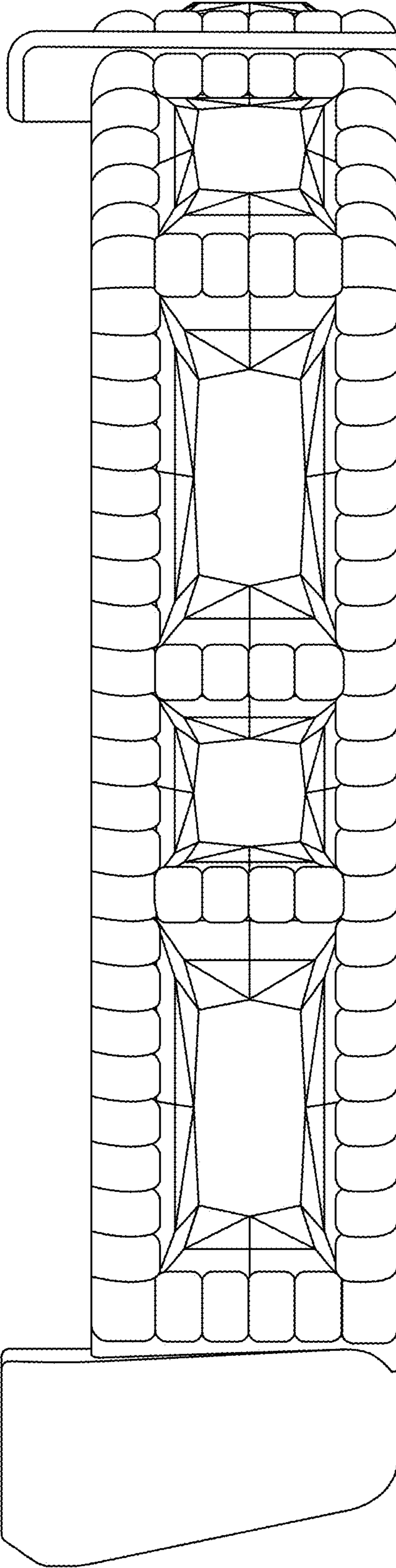

FIGURE 5

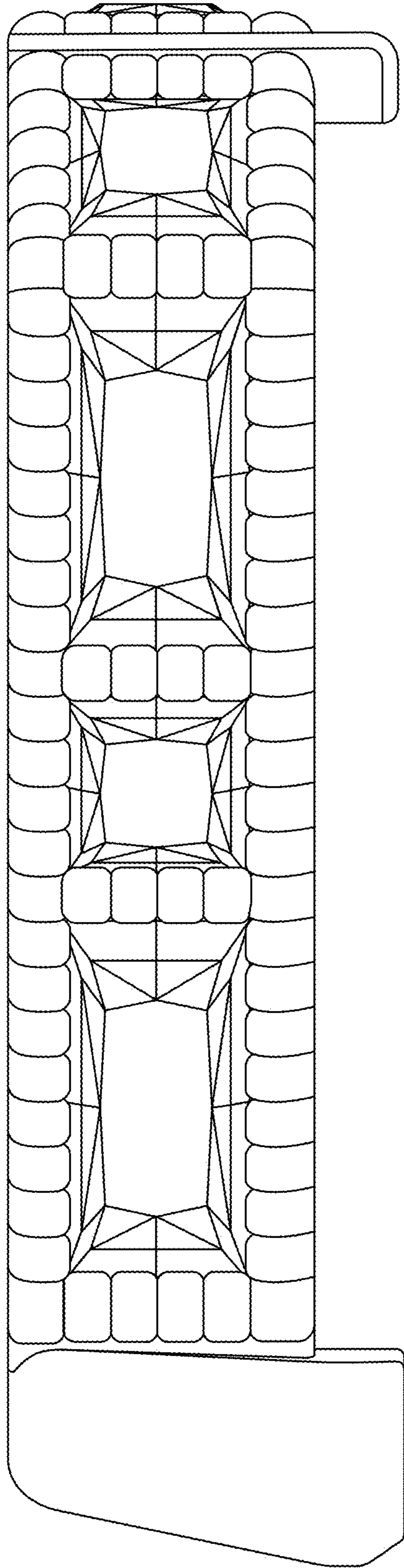

FIGURE 6



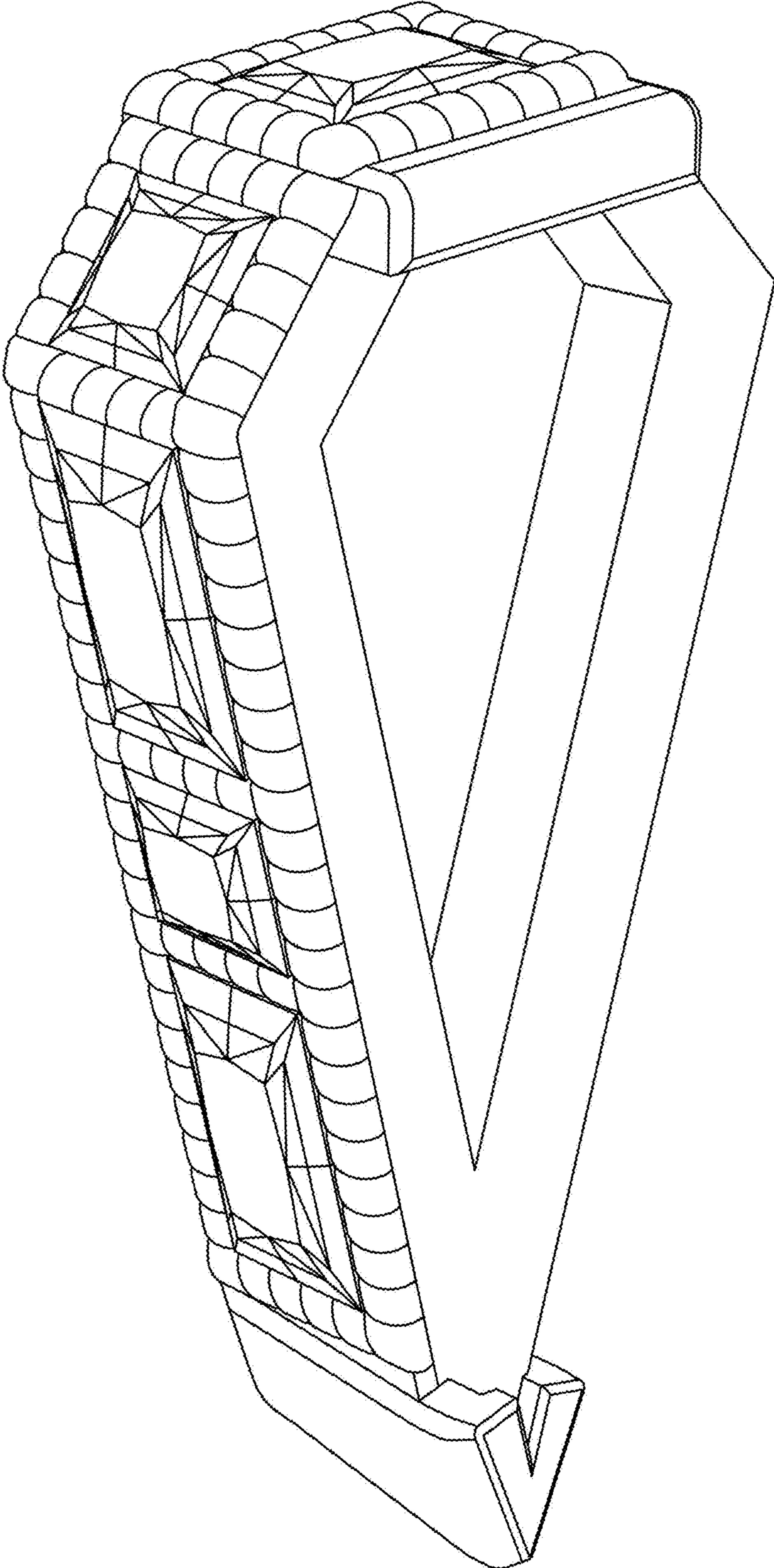

FIGURE 7

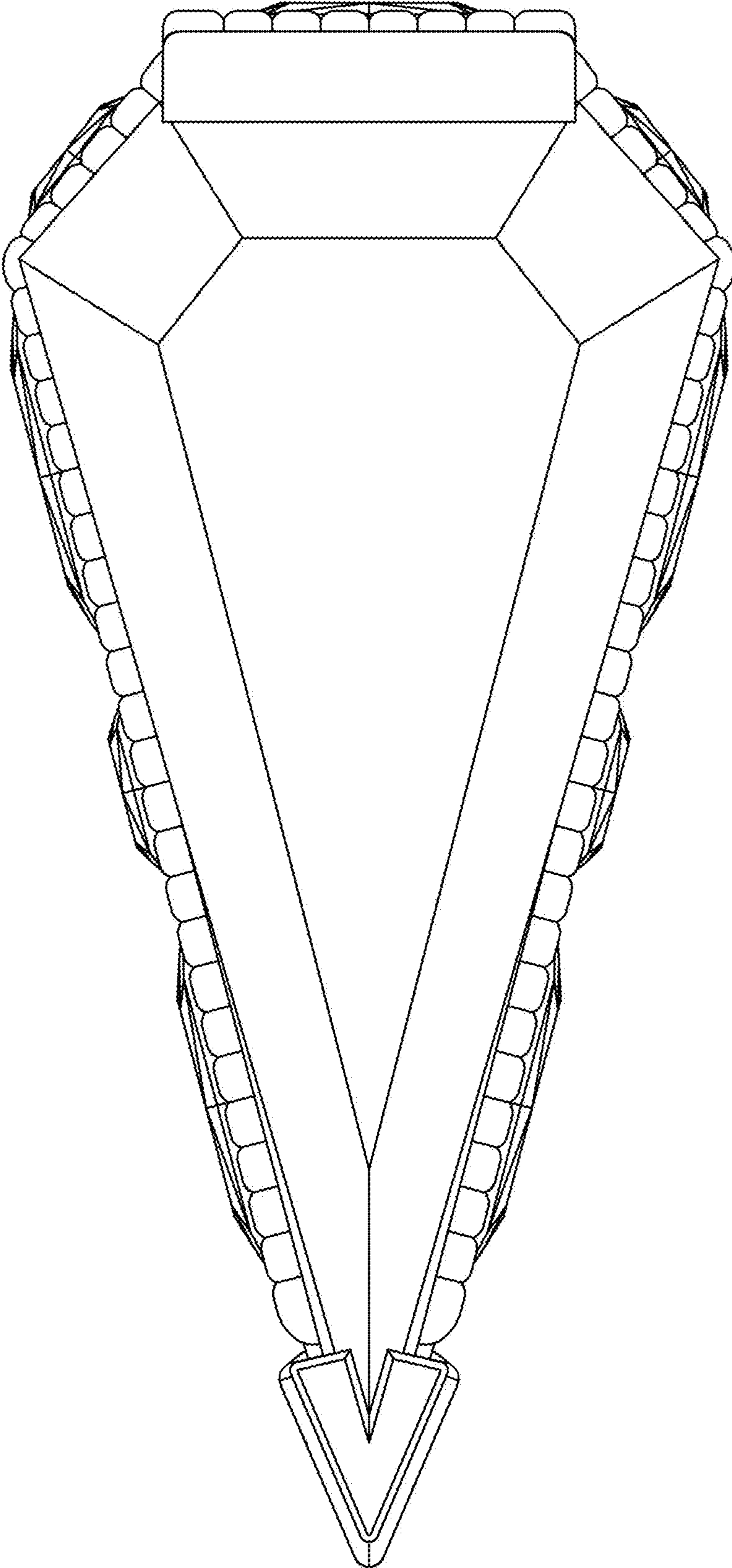

FIGURE 8

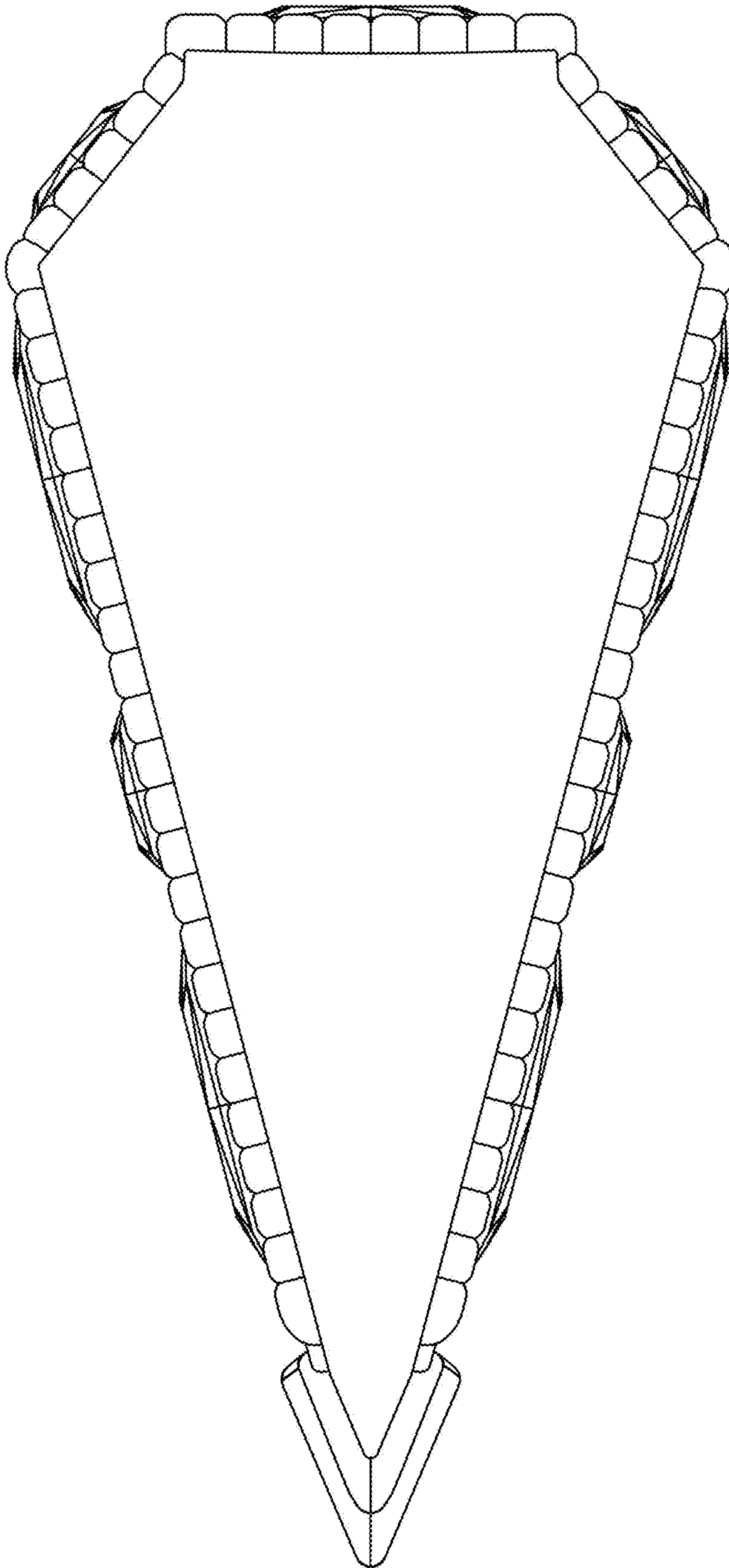

FIGURE 9

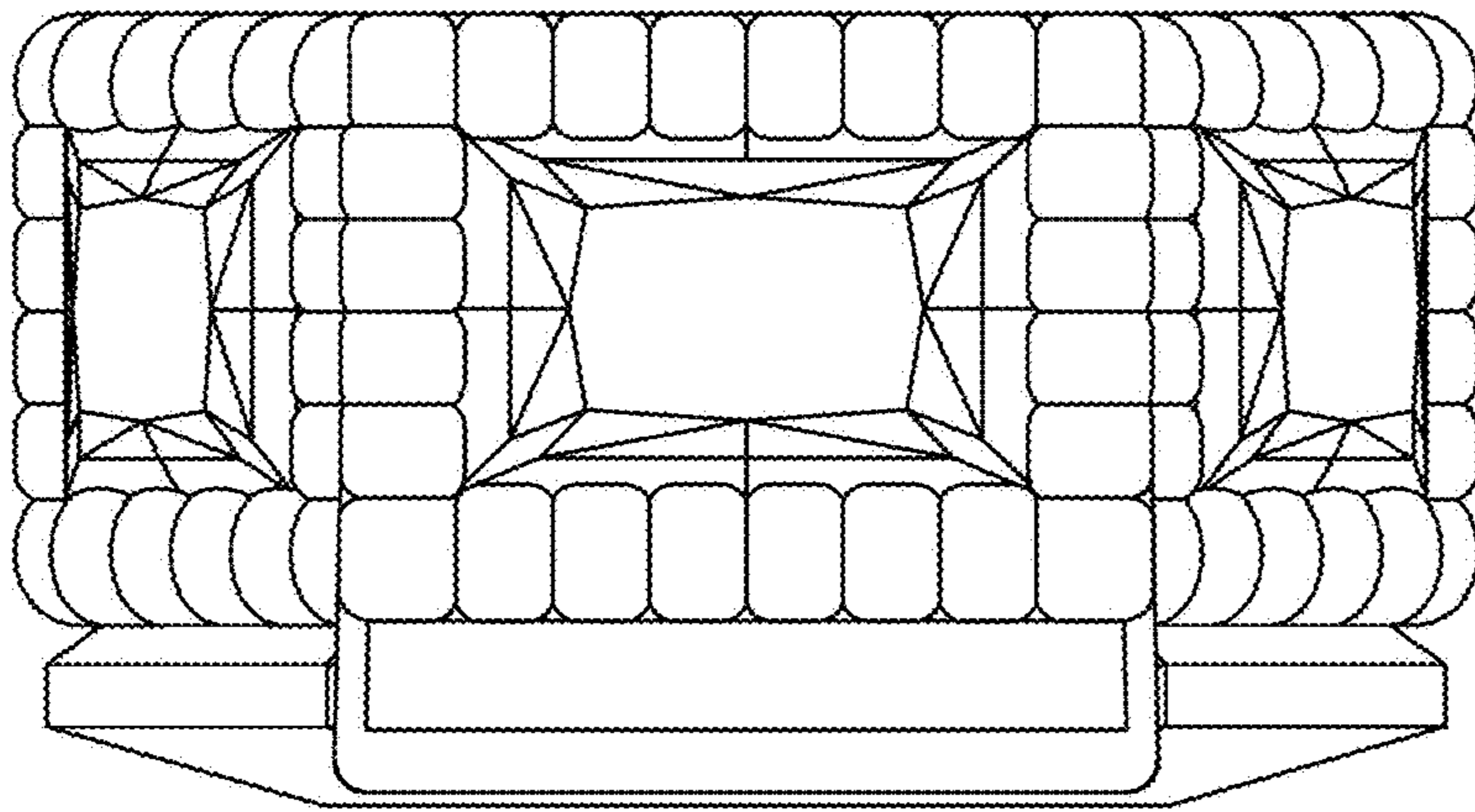

FIGURE 10

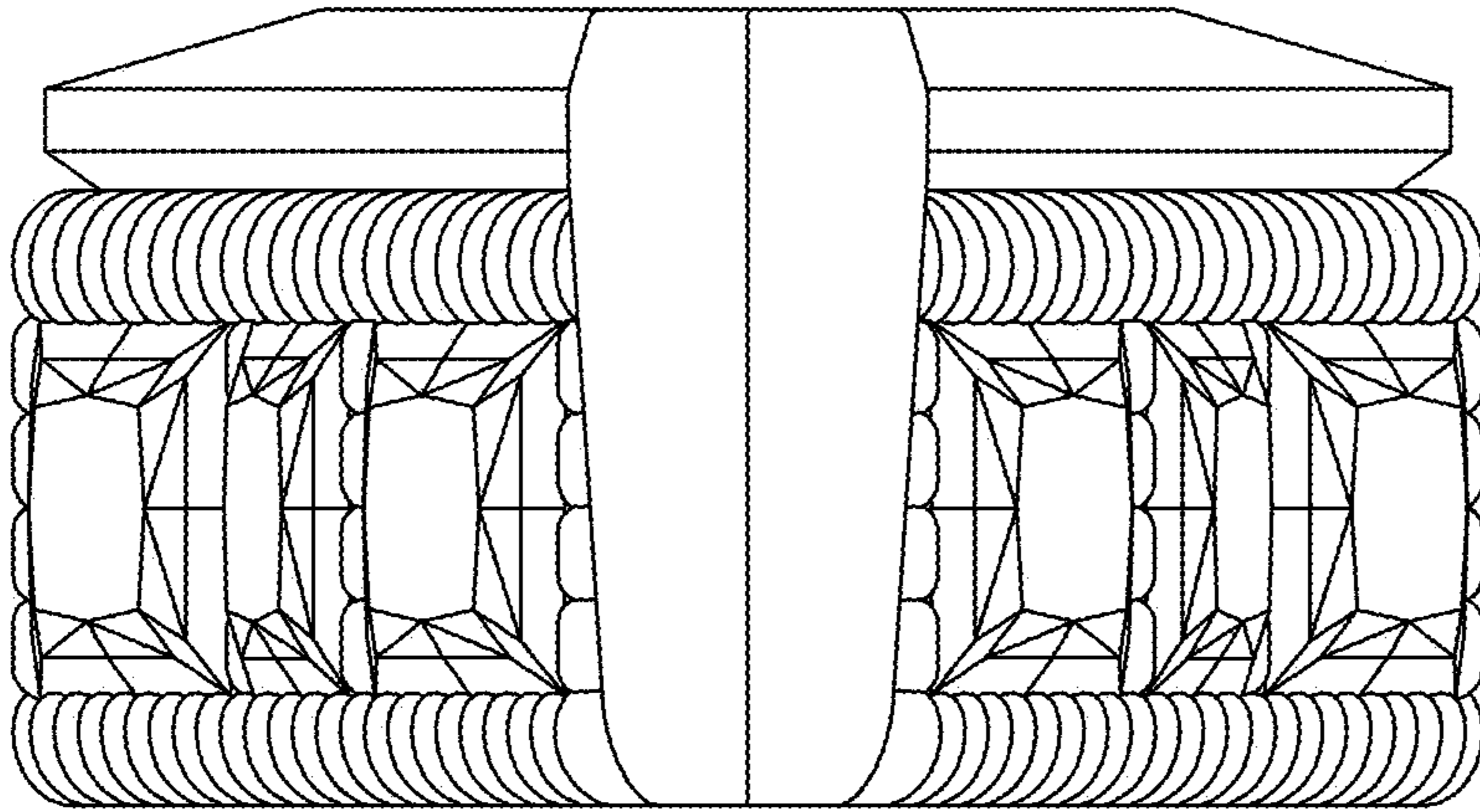

FIGURE 11

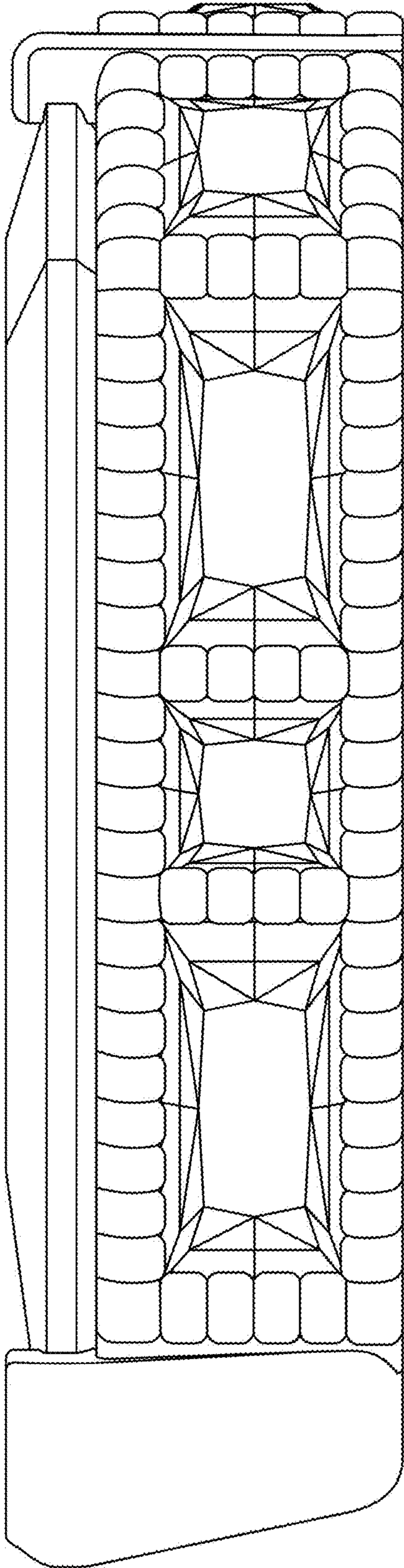

FIGURE 12

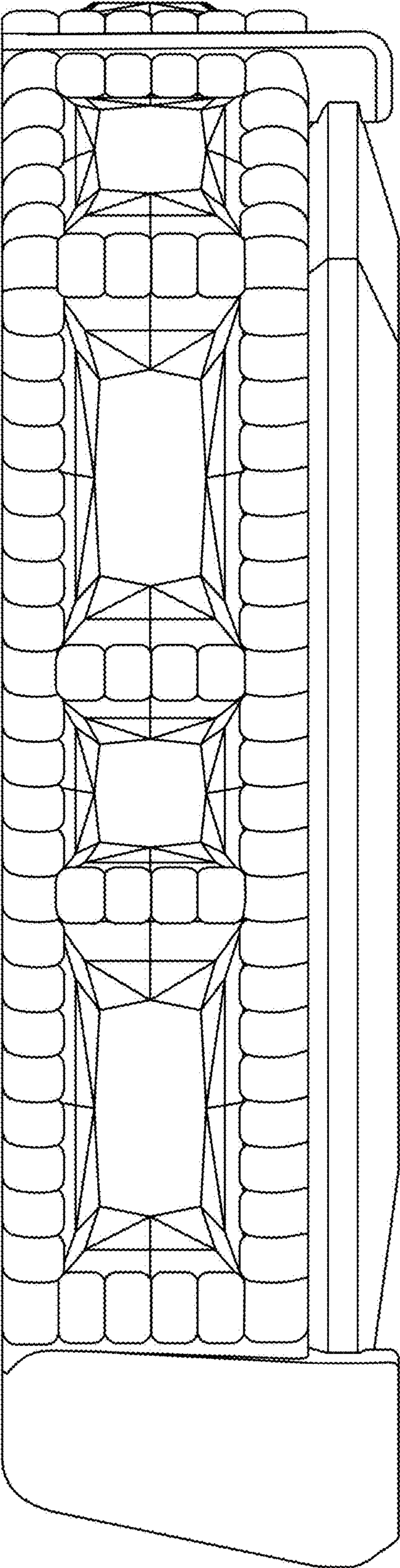

FIGURE 13

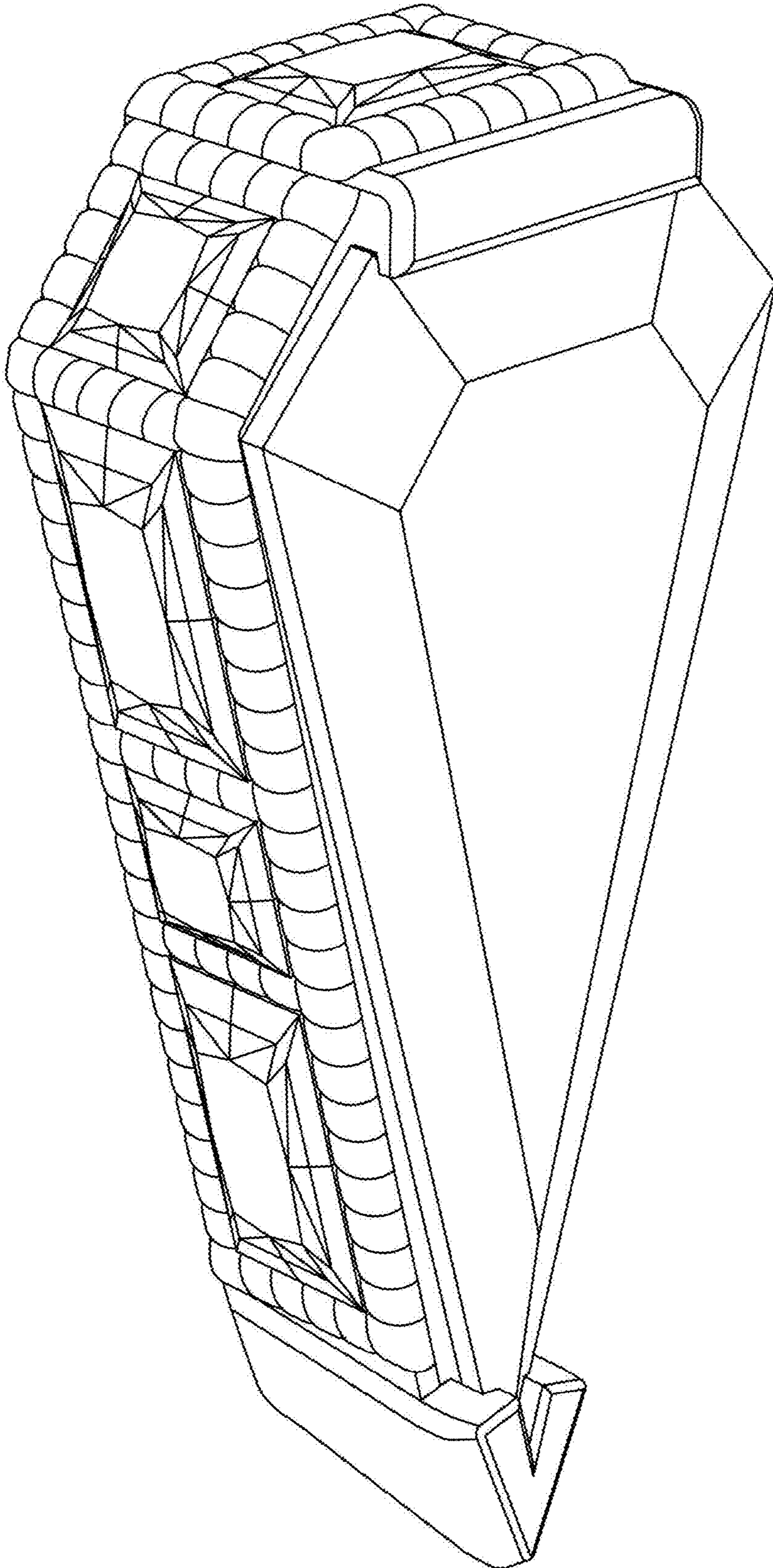

FIGURE 14