



US00D974195S

(12) **United States Design Patent**
Zhao

(10) **Patent No.:** **US D974,195 S**
(45) **Date of Patent:** **** Jan. 3, 2023**

- (54) **INFRARED THERMOMETER**
- (71) Applicant: **Shenzhen Sonida Digital Technology Co., Ltd., Shenzhen (CN)**
- (72) Inventor: **Kundian Zhao, Guangzhou (CN)**
- (73) Assignee: **Shenzhen Sonida Digital Technology Co., Ltd., Shenzhen (CN)**
- (**) Term: **15 Years**
- (21) Appl. No.: **29/783,099**
- (22) Filed: **May 11, 2021**
- (51) **LOC (14) Cl.** **10-04**
- (52) **U.S. Cl.**
USPC **D10/57**
- (58) **Field of Classification Search**
USPC D10/57
CPC G01K 1/08; G01K 13/20; G01K 13/223;
G01K 13/25; G01K 13/252; G01K 1/083;
G01K 1/18; G01K 13/002; G01J 5/04;
G01J 5/041; G01J 5/042; G01J 5/043;
G01J 5/044; G01J 5/045; G01J 5/046;
G01J 5/047; G01J 5/048; G01J 5/049;
G01J 5/0265; A61K 31/185; A61K
9/0004; A61K 9/2009; A61K 9/2018;
A61K 9/2054; A61K 9/2086; A61K
9/209; A61K 9/2846; A61K 9/485; A61K
9/5047; A61K 9/2886; A61K 31/64;
A61K 9/20; A61P 25/28; A61P 43/00
See application file for complete search history.

- (56) **References Cited**
U.S. PATENT DOCUMENTS
D614,978 S * 5/2010 Houlihan D10/57
D616,772 S * 6/2010 Guo D10/57
D617,216 S * 6/2010 Guo G01J 5/021
D10/57

- D617,217 S * 6/2010 Houlihan G01J 5/021
D10/57
- D620,819 S * 8/2010 Houlihan G01J 5/021
D10/57
- D637,921 S * 5/2011 Houlihan D10/57
- D693,247 S * 11/2013 Juhng D10/57
- D774,406 S * 12/2016 Im D10/57
- D804,332 S * 12/2017 Lim D10/57
- D805,927 S * 12/2017 Verbrugge D10/57
- D827,457 S * 9/2018 Liu D10/57
- D842,137 S * 3/2019 Wang D10/57
- D858,318 S * 9/2019 Terlouw G01J 5/026
D10/57
- D881,041 S * 4/2020 Luo G01J 5/026
D10/57
- D881,042 S * 4/2020 Luo G01J 5/021
D10/57
- D916,605 S * 4/2021 Yue G01J 5/021
D10/57

(Continued)

Primary Examiner — Antoine Duval Davis
(74) *Attorney, Agent, or Firm* — ScienBiziP, P.C.

(57) **CLAIM**
The ornamental design for an infrared thermometer, as shown and described.

DESCRIPTION
FIG. 1 is a front, right, and top perspective view of an infrared thermometer, showing my design.
FIG. 2 is a rear, left, and bottom perspective view thereof.
FIG. 3 is a front elevation view thereof.
FIG. 4 is a rear elevation view thereof.
FIG. 5 is a left side elevation view thereof.
FIG. 6 is a right side elevation view thereof.
FIG. 7 is a top plan view thereof; and,
FIG. 8 is a bottom plan view thereof.
The broken lines shown in the drawings are included for the purpose of illustrating portions of the infrared thermometer that form no part of the claimed design.

1 Claim, 8 Drawing Sheets

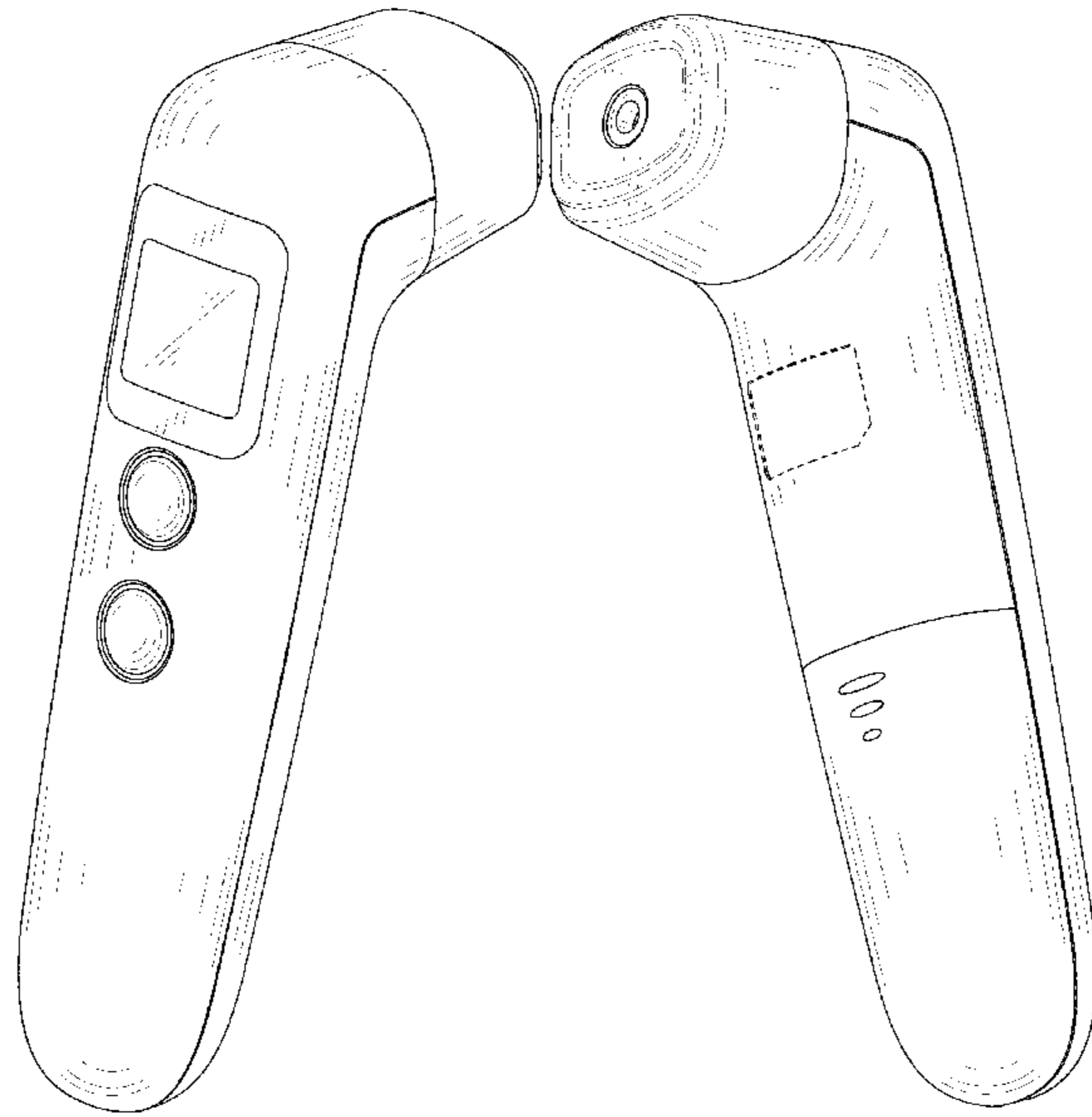

(56)

References Cited

U.S. PATENT DOCUMENTS

D919,459	S *	5/2021	Zeng	G01J 5/021 D10/57
D925,081	S *	7/2021	Ke	D26/37
D944,663	S *	3/2022	Yang	D10/57
D945,890	S *	3/2022	McGilloway	D10/57
D949,028	S *	4/2022	Chen	D10/57
D949,714	S *	4/2022	Tan	D10/57
D950,402	S *	5/2022	Huang	G01J 5/026 D10/57
D952,478	S *	5/2022	Feng	D10/57
D952,480	S *	5/2022	Cong	D10/57
11,402,277	B2 *	8/2022	Liang	G01J 5/026
2021/0010867	A1 *	1/2021	Li	G01J 5/021

* cited by examiner

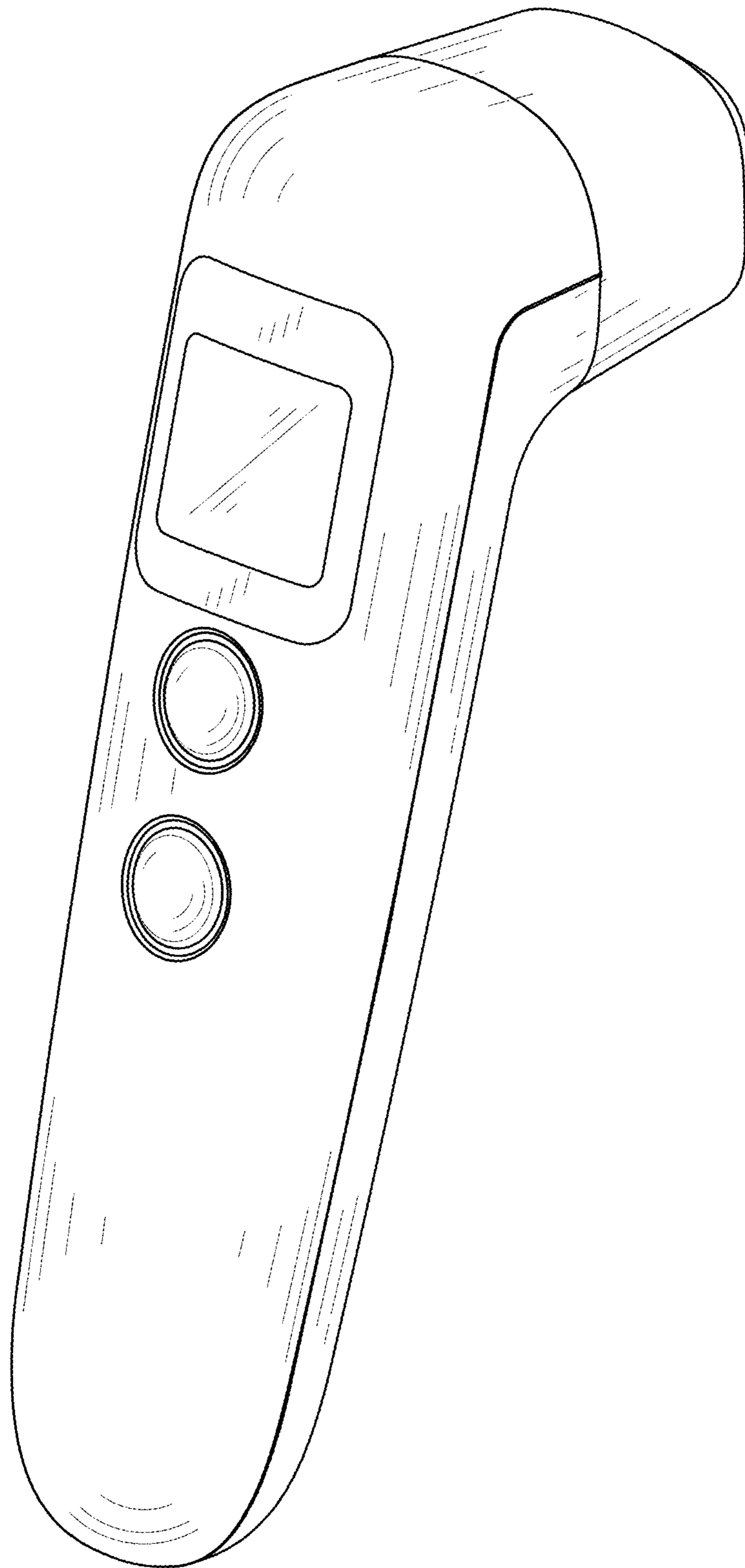

FIG. 1

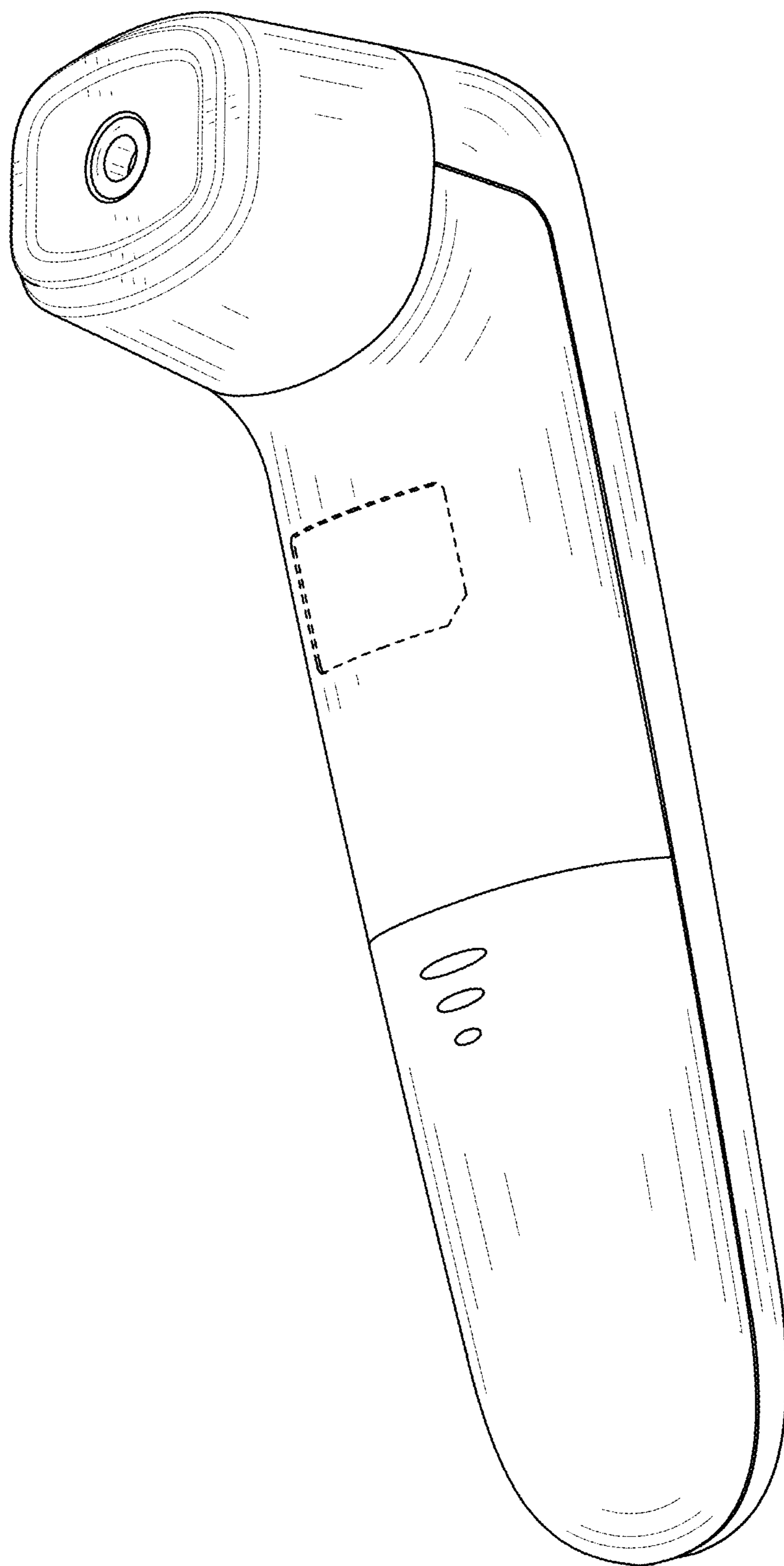

FIG. 2

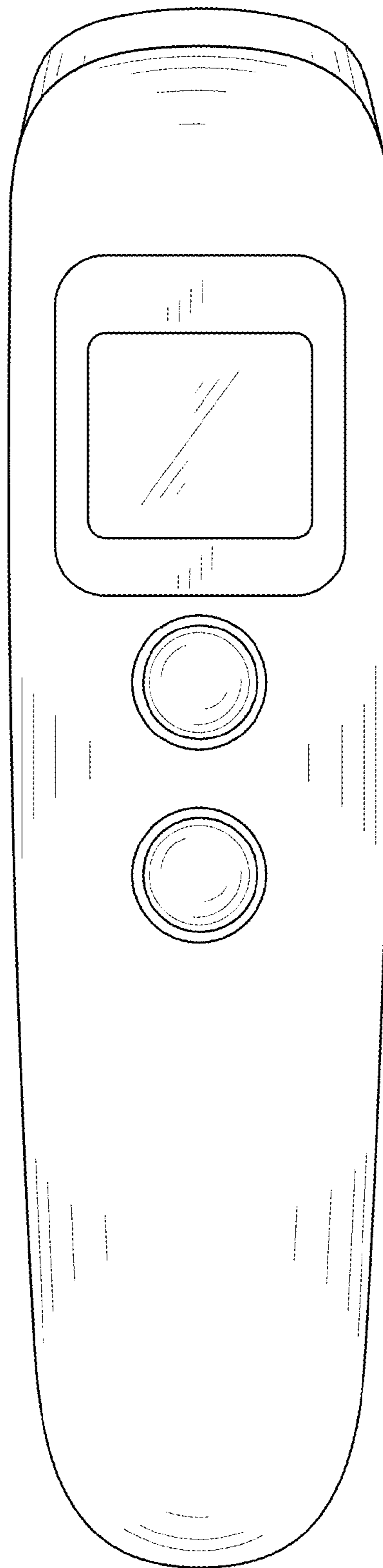

FIG. 3

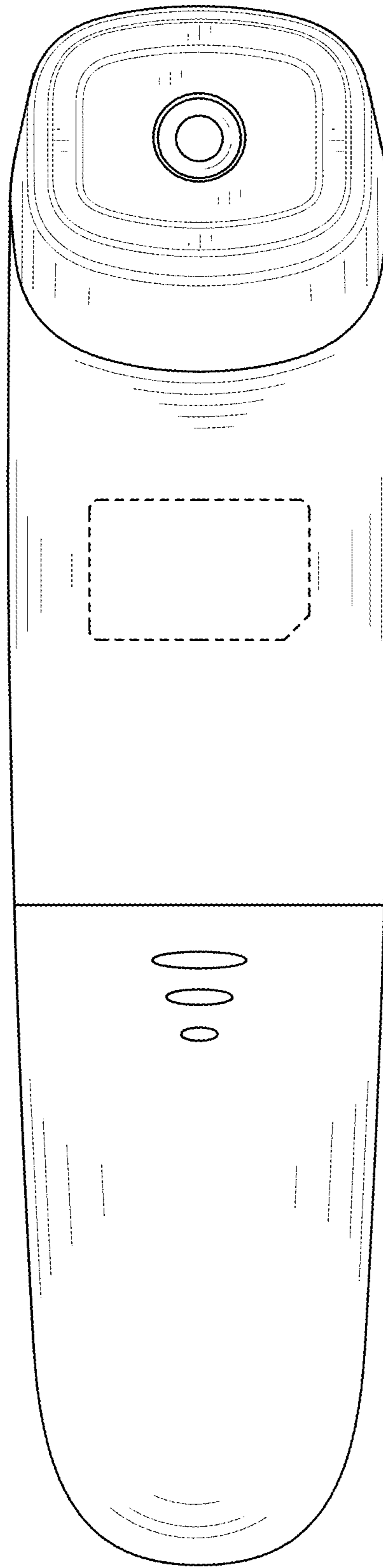

FIG. 4

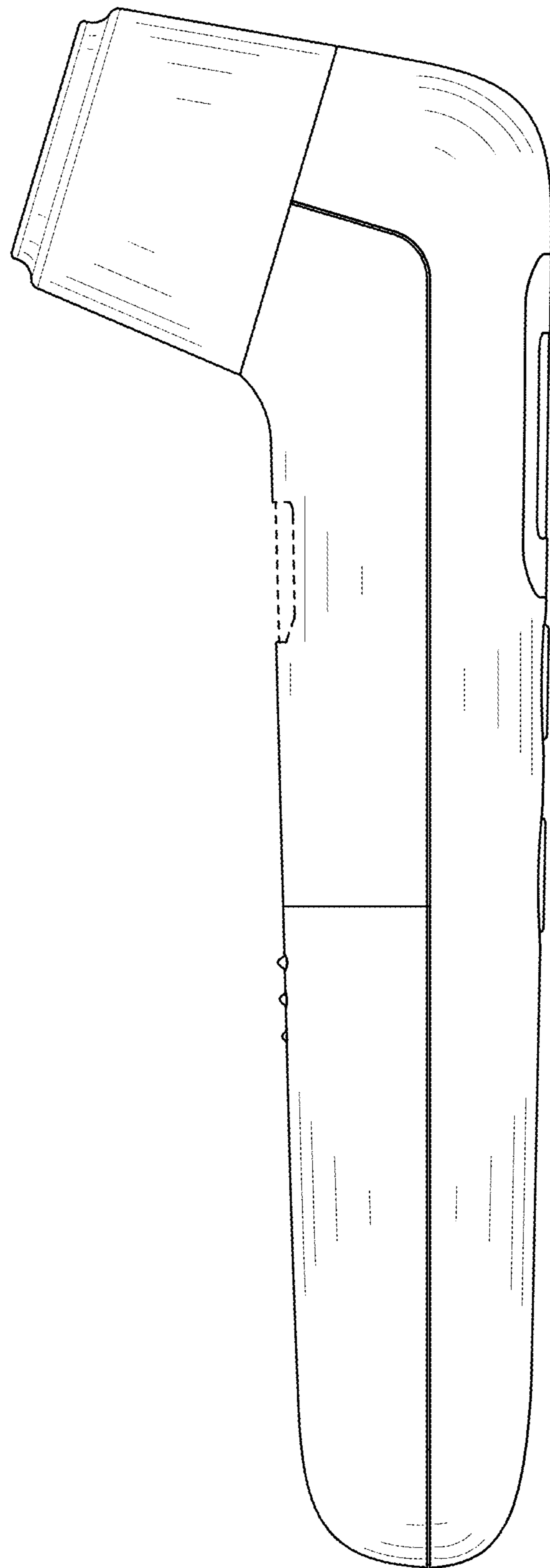

FIG. 5

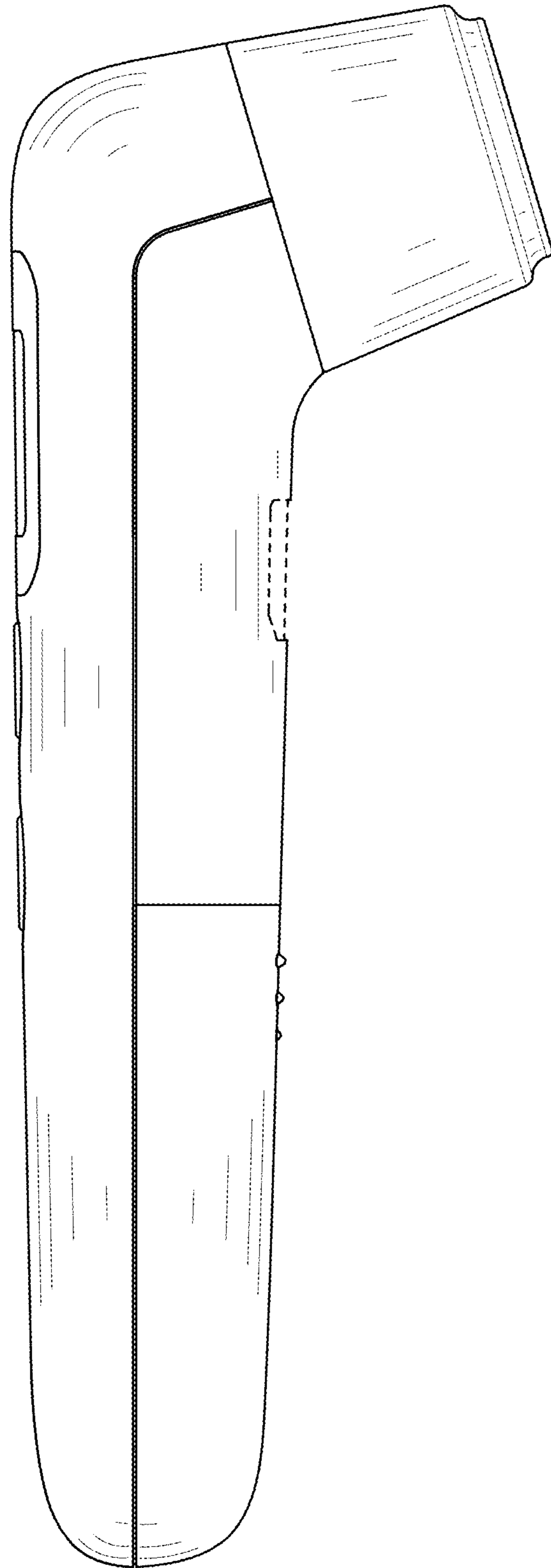

FIG. 6

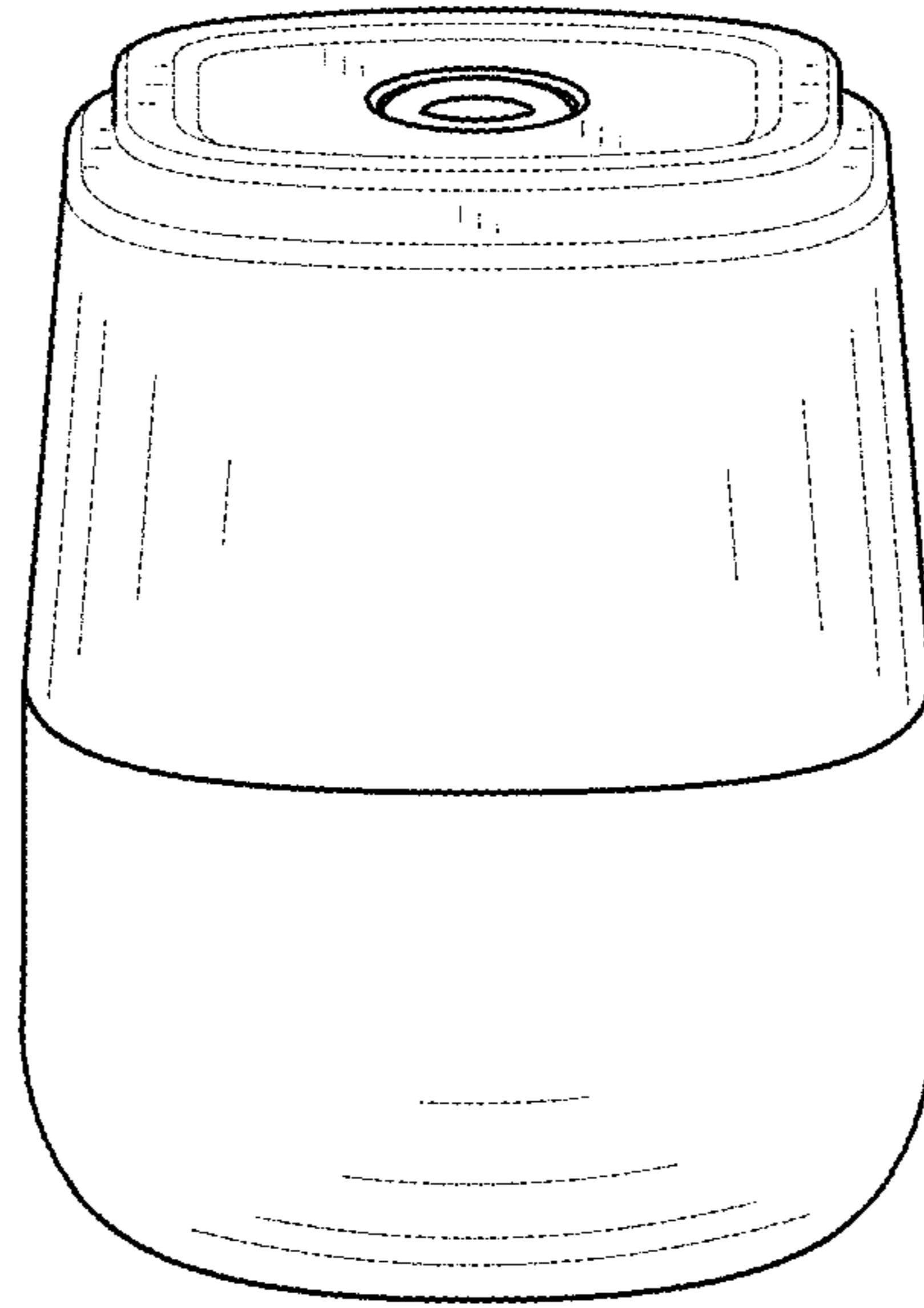

FIG. 7

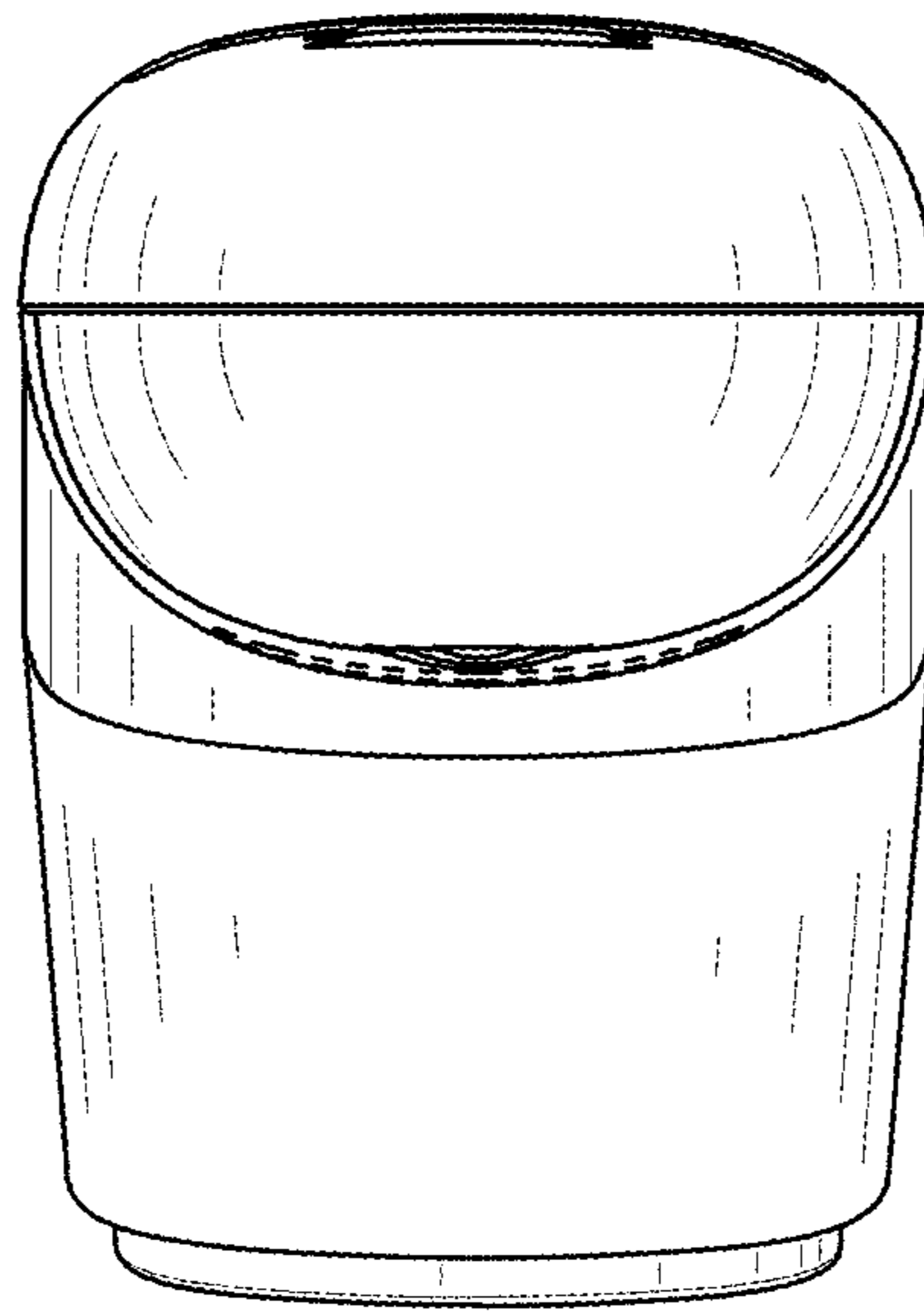

FIG. 8