



US00D974115S

(12) **United States Design Patent**  
**Khachatryan**

(10) **Patent No.:** **US D974,115 S**  
(45) **Date of Patent:** **\*\* Jan. 3, 2023**

(54) **TRANSFORMABLE ROTATING BROILING RACK**

(71) Applicant: **Araik Khachatryan**, Kyiv (UA)

(72) Inventor: **Araik Khachatryan**, Kyiv (UA)

(\*\*) Term: **15 Years**

(21) Appl. No.: **35/512,918**

(22) Filed: **Aug. 13, 2021**

(80) **Hague Agreement Data**

Int. Filing Date: **Aug. 13, 2021**

Int. Reg. No.: **DM/217164**

Int. Reg. Date: **Aug. 13, 2021**

Int. Reg. Pub. Date: **Nov. 12, 2021**

(51) **LOC (14) Cl.** ..... **07-02**

(52) **U.S. Cl.**

USPC ..... **D7/409**

(58) **Field of Classification Search**

USPC ..... D7/323, 332, 335-337, 354-355,  
D7/359-364, 387-388, 402, 407-409, 698

CPC .... A21B 2/00; A21B 3/00; A21B 3/13; A21B  
3/15; A21B 5/00; A21B 5/02; A23N  
12/06; A23N 12/08; A23N 12/10; A47J  
37/00; A47J 37/04; A47J 37/041; A47J  
37/042; A47J 37/047; A47J 37/049; A47J  
37/06; A47J 37/0688; A47J 37/0694;  
A47J 37/07; A47J 37/0704; A47J  
37/0745; A47J 37/10; A47J 47/20; A47J  
2037/00; A47J 2037/06; A47J 2037/0611;  
A47J 2037/07; A47J 2037/0786; A47J  
2037/0795; F24C 15/10; F24C 15/12;  
F24C 15/14; F24C 15/16; F24C 15/18;  
F24C 15/164; A47B 55/02; G07F 9/105

See application file for complete search history.

(56) **References Cited**

**U.S. PATENT DOCUMENTS**

2,846,941 A \* 8/1958 Goodwin ..... A47J 37/049  
99/450

3,188,939 A \* 6/1965 Smith ..... A47J 37/041  
24/DIG. 54

3,604,408 A \* 9/1971 Tescula ..... A47J 37/0688  
126/25 R

3,867,877 A \* 2/1975 Zajc ..... A47J 37/049  
99/402

4,442,762 A \* 4/1984 Beller ..... A47J 37/0704  
99/449

4,442,763 A \* 4/1984 Beller ..... A47J 37/0745  
99/449

5,205,208 A \* 4/1993 Gongwer ..... G07F 9/105  
99/402

5,325,767 A \* 7/1994 Beller ..... A47J 37/049  
99/427

6,367,373 B2 \* 4/2002 Bargman ..... A47J 37/0694  
99/449

D802,364 S \* 11/2017 Khachatryan ..... D7/409

D961,329 S \* 8/2022 Yan ..... D7/402

(Continued)

**OTHER PUBLICATIONS**

Only fire 6042 BBQ Stainless Steel Flat Spit Rotisserie Grill Basket.  
Date Reviewed on Amazon.com May 17, 2021. [https://www.amazon.com/only-fire-Rotisserie-Basket/dp/B07CDR3DJ4/ref\(Year: 2021\).\\*](https://www.amazon.com/only-fire-Rotisserie-Basket/dp/B07CDR3DJ4/ref(Year: 2021).*)

*Primary Examiner* — Ricky Pham

(57) **CLAIM**

The ornamental design for transformable rotating broiling rack, as shown and described.

**DESCRIPTION**

- 1. Transformable rotating broiling rack
- 1.1 : Perspective
- 1.2 : Front
- 1.3 : Back
- 1.4 : Left
- 1.5 : Top
- 1.6 : Perspective view of transformed product
- 1.7 : Side view of transformed product

**1 Claim, 7 Drawing Sheets**

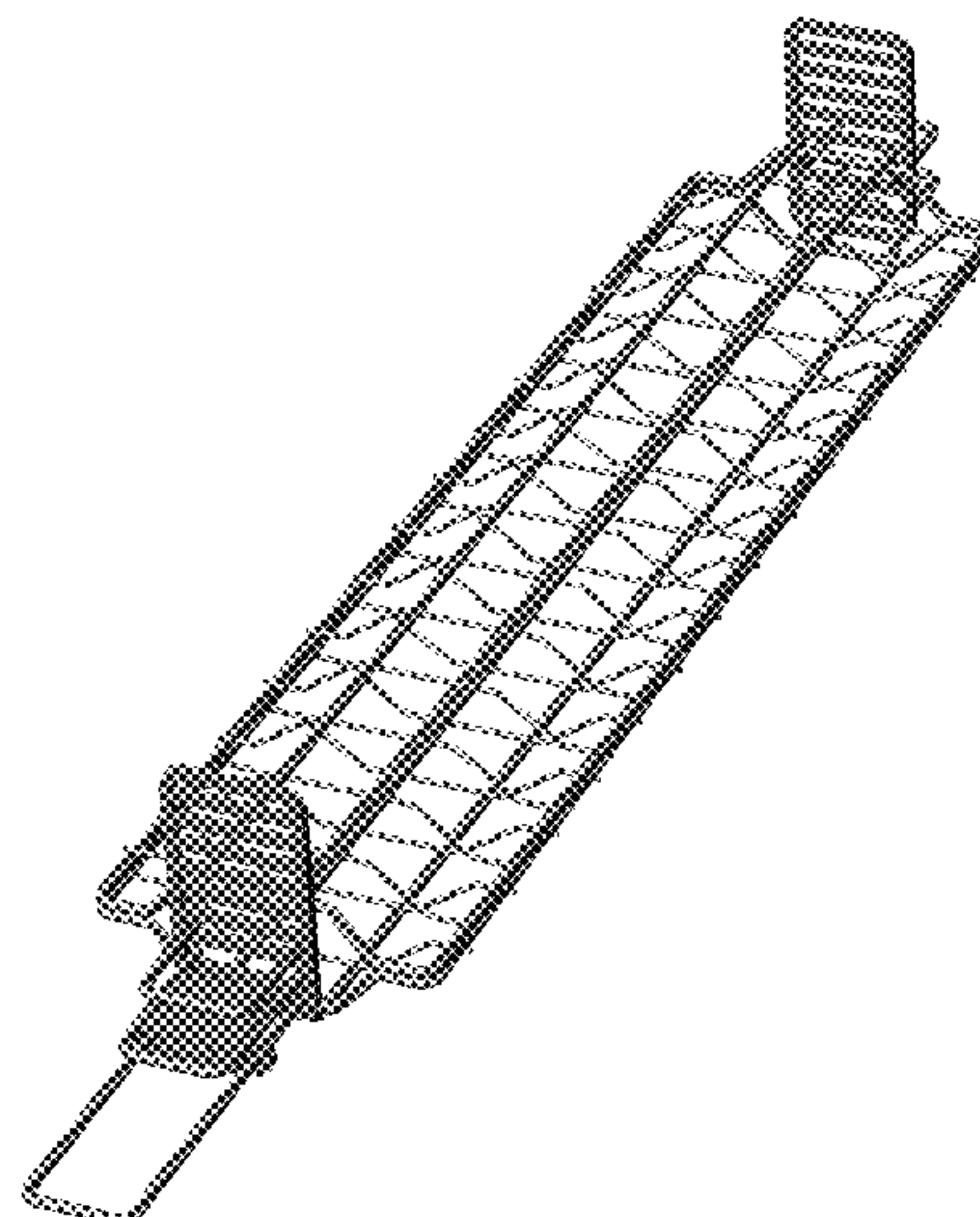

(56)

**References Cited**

U.S. PATENT DOCUMENTS

2005/0016387 A1\* 1/2005 Sigman ..... A47J 37/047  
99/421 R  
2015/0313412 A1\* 11/2015 Laub ..... A47B 55/02  
99/415

\* cited by examiner

1.1

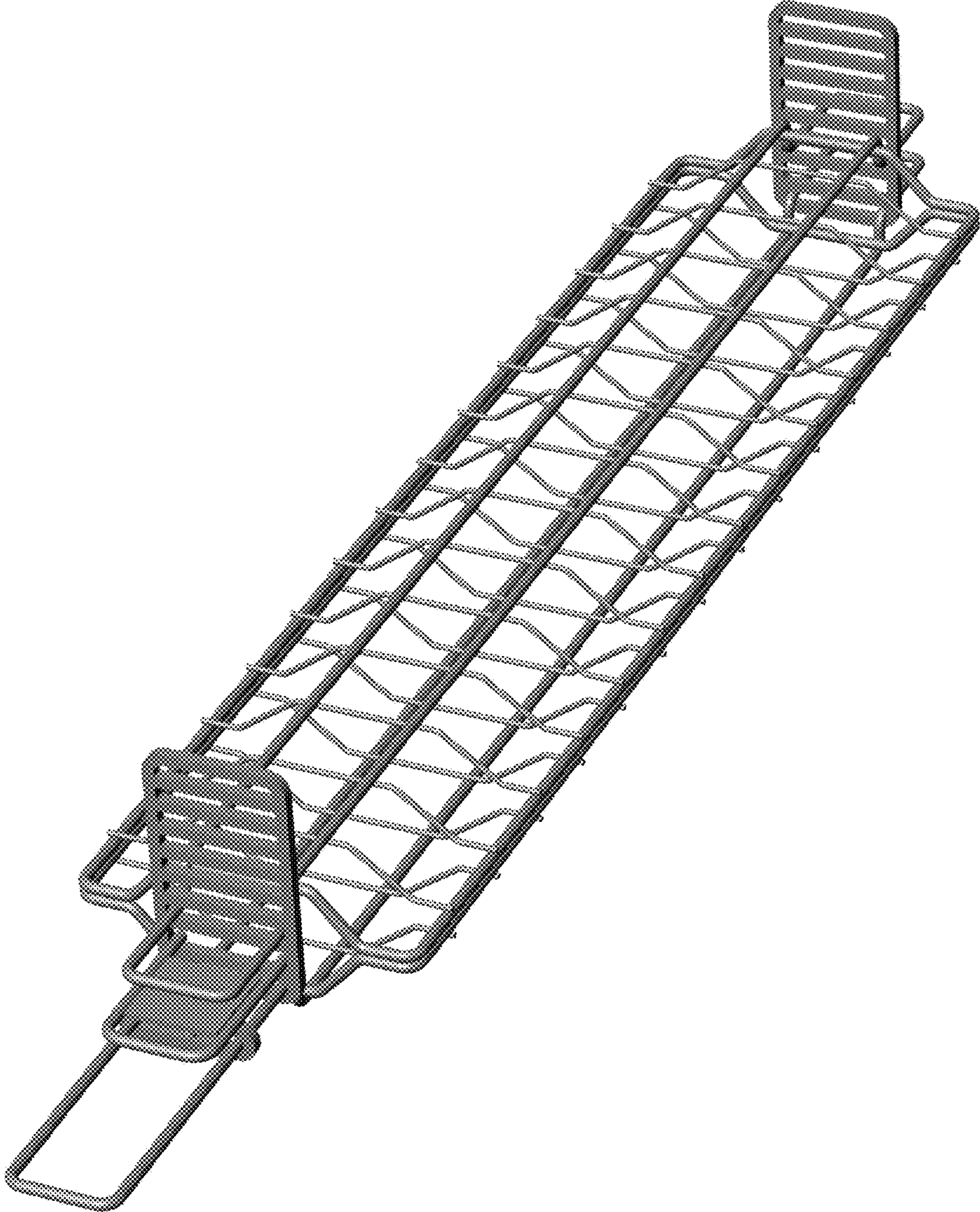



1.2

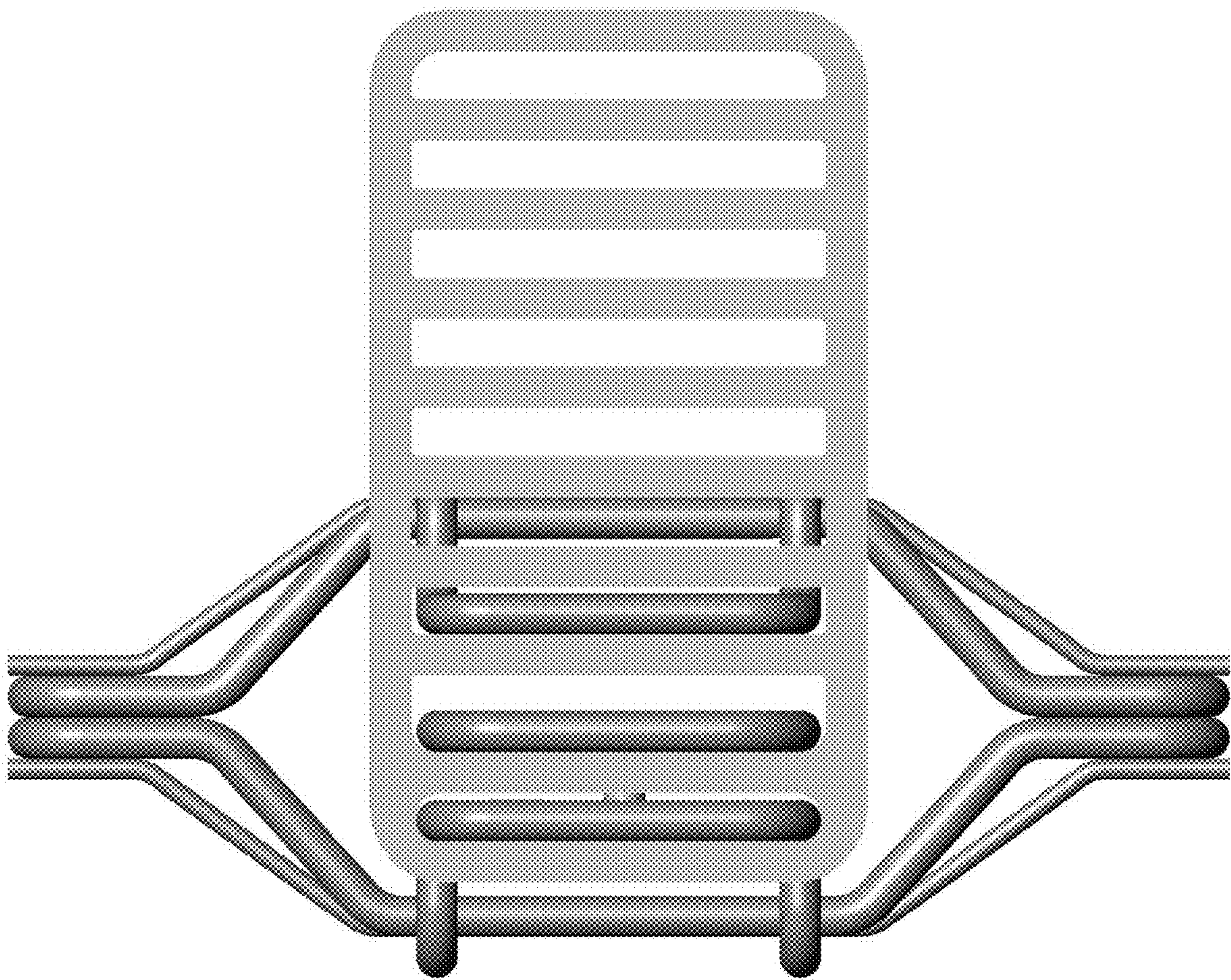



1.3

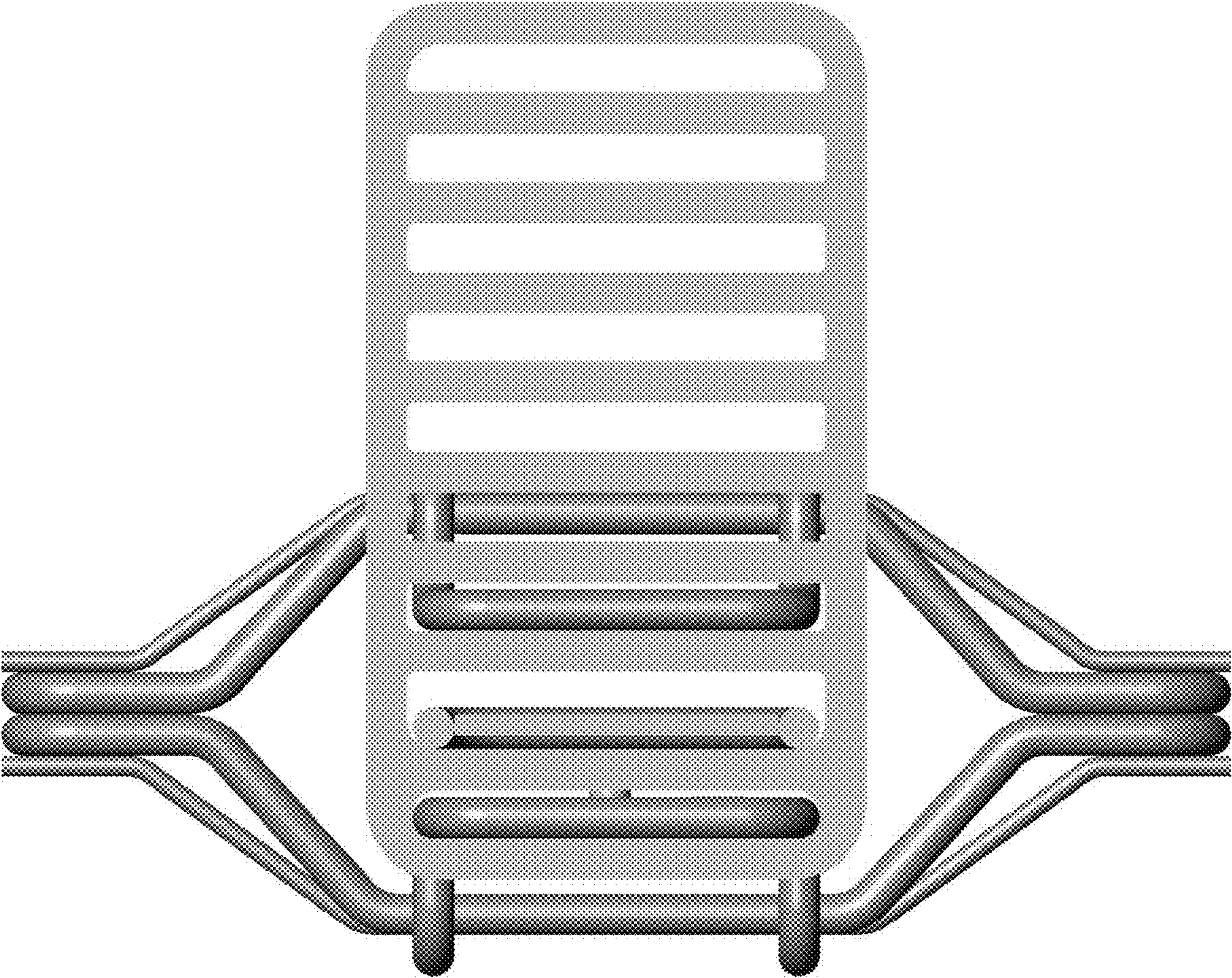

1.4

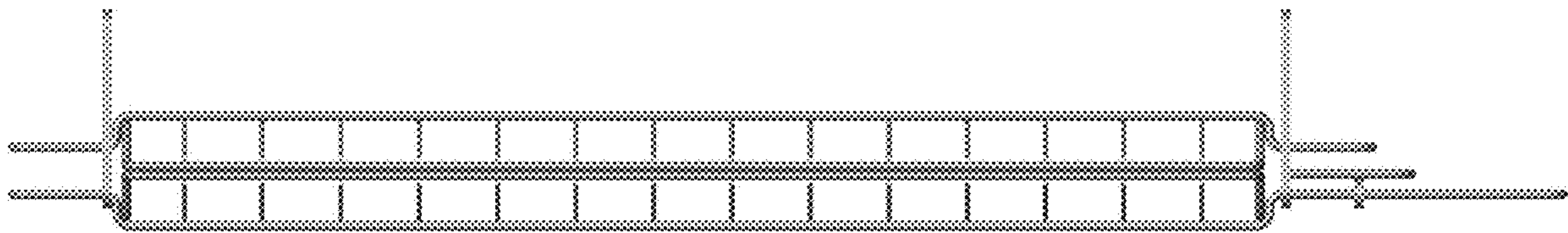

1.5

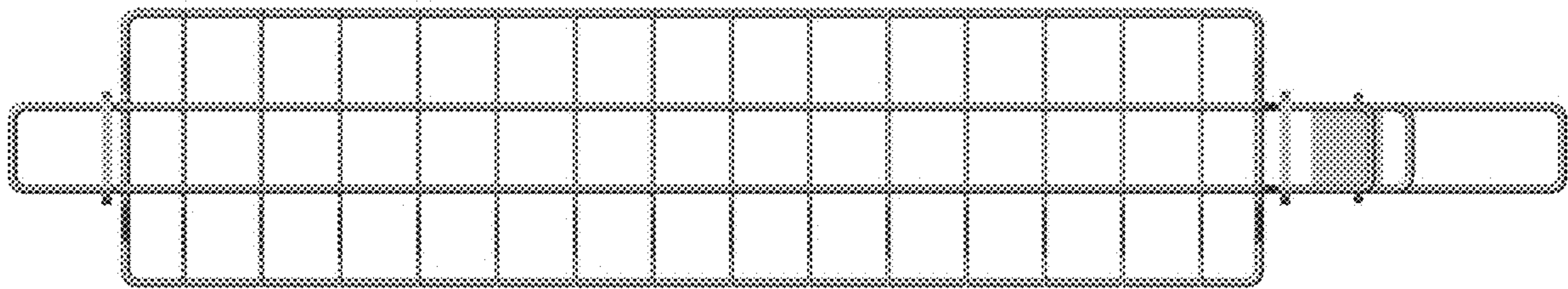



1.6

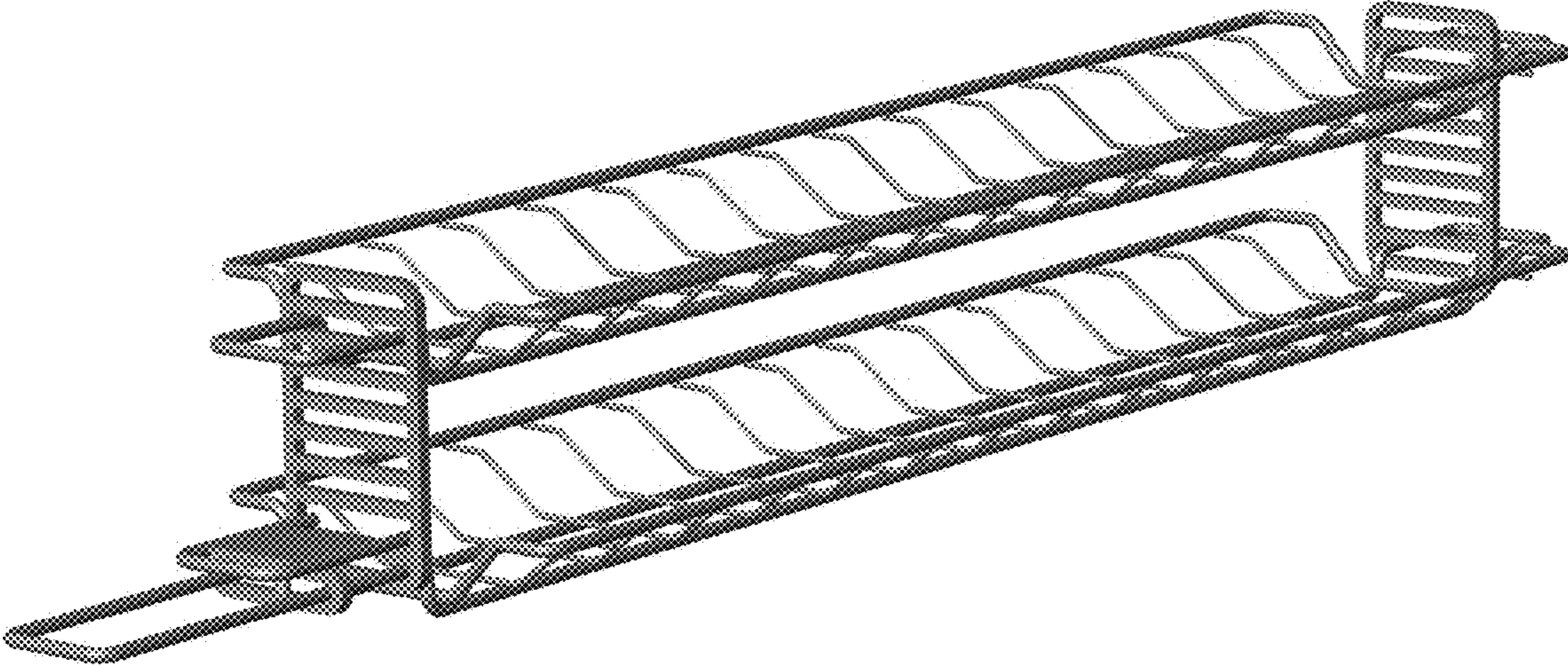



1.7

