



US00D974079S

(12) **United States Design Patent** (10) **Patent No.:** **US D974,079 S**
Allender (45) **Date of Patent:** **** Jan. 3, 2023**

(54) **BEACH BLANKET WITH SUPPORTED SIDEWALLS AND ATTACHED CARRY POUCH**

(71) Applicant: **Ski Allender**, Vacaville, CA (US)

(72) Inventor: **Ski Allender**, Vacaville, CA (US)

(**) Term: **15 Years**

(21) Appl. No.: **29/750,591**

(22) Filed: **Sep. 15, 2020**

(51) **LOC (14) Cl.** **06-13**

(52) **U.S. Cl.**
USPC **D6/603**

(58) **Field of Classification Search**
USPC D3/233, 305; D6/595, 596, 602, 603,
D6/608, 616; D21/815
CPC A47G 9/06; A47G 9/062; A47C 17/64
See application file for complete search history.

(56) **References Cited**

U.S. PATENT DOCUMENTS

634,507	A *	10/1899	Smith	B65D 71/36 5/482
D112,440	S *	12/1938	Smith	D25/56
D311,473	S *	10/1990	Vrabel	D6/603
5,473,785	A *	12/1995	Lager	A47D 13/02 5/655
D370,960	S *	6/1996	Bookstaver	D21/815
7,607,182	B1 *	10/2009	Weiner	A47G 9/062 5/418
D624,345	S *	9/2010	Diaz, Jr.	D6/602
D707,062	S *	6/2014	Fraioli	D3/233
D715,582	S *	10/2014	Mun	D6/602
D774,802	S *	12/2016	Bergeman	D6/596
2020/0008594	A1 *	1/2020	Novacek	E04H 15/005
2022/0151407	A1 *	5/2022	Novacek	A47G 9/062
2022/0240696	A1 *	8/2022	Wright	A47G 9/062

OTHER PUBLICATIONS

Surf Sheet, Gadget Flow Article. Date Published: Jun. 6, 2022, Date Accessed: Aug. 8, 2022. Accessed on the Internet URL: <https://thegadgetflow.com/portfolio/surf-sheet-sand-free-beach-blanket-uses-upright-sides-to-keep-sand-off-flat-surface/> (Year: 2022).*

* cited by examiner

Primary Examiner — S. Bryan Reinholdt, Jr.

Assistant Examiner — Julia S Folkart

(74) *Attorney, Agent, or Firm* — Craig A. Simmermon

(57) **CLAIM**

I claim the ornamental design for a beach blanket with supported sidewalls and attached carry pouch, as shown and described.

DESCRIPTION

FIG. 1 is a top perspective view of a beach blanket with supported sidewalls and attached carry pouch showing my new design;
FIG. 2 is a front elevation view thereof;
FIG. 3 is a rear elevation view thereof;
FIG. 4 is a left side elevation view thereof;
FIG. 5 is a right side elevation view thereof;
FIG. 6 is a top plan view thereof;
FIG. 7 is a bottom plan view thereof;
FIG. 8 is a top perspective view of the beach blanket with supported sidewalls and attached carry pouch of FIG. 1 shown in a stored configuration;
FIG. 9 is a front elevation view thereof;
FIG. 10 is a rear elevation view thereof;
FIG. 11 is a left side elevation view thereof;
FIG. 12 is a right side elevation view thereof;
FIG. 13 is a top plan view thereof; and,
FIG. 14 is a bottom plan view thereof.

1 Claim, 9 Drawing Sheets

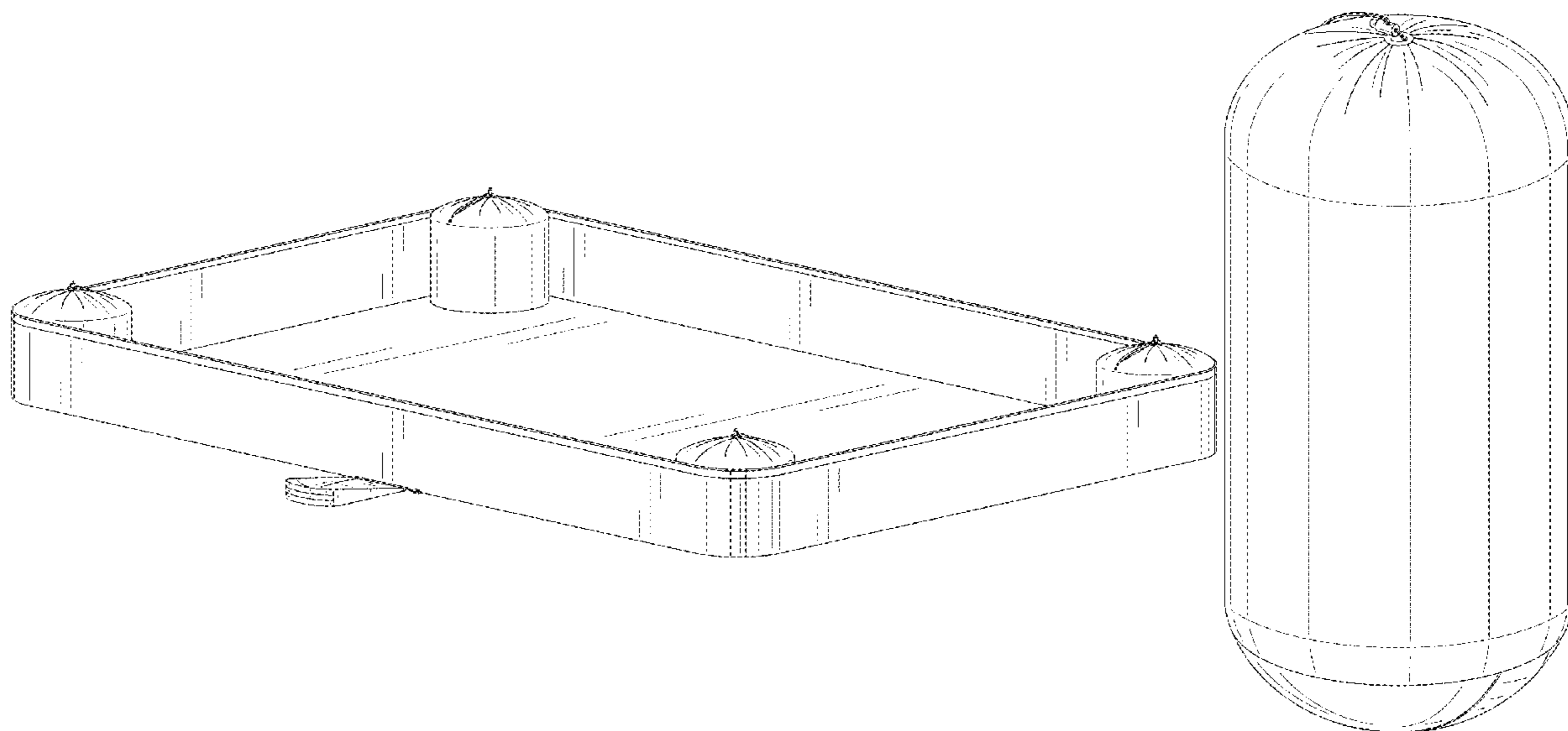

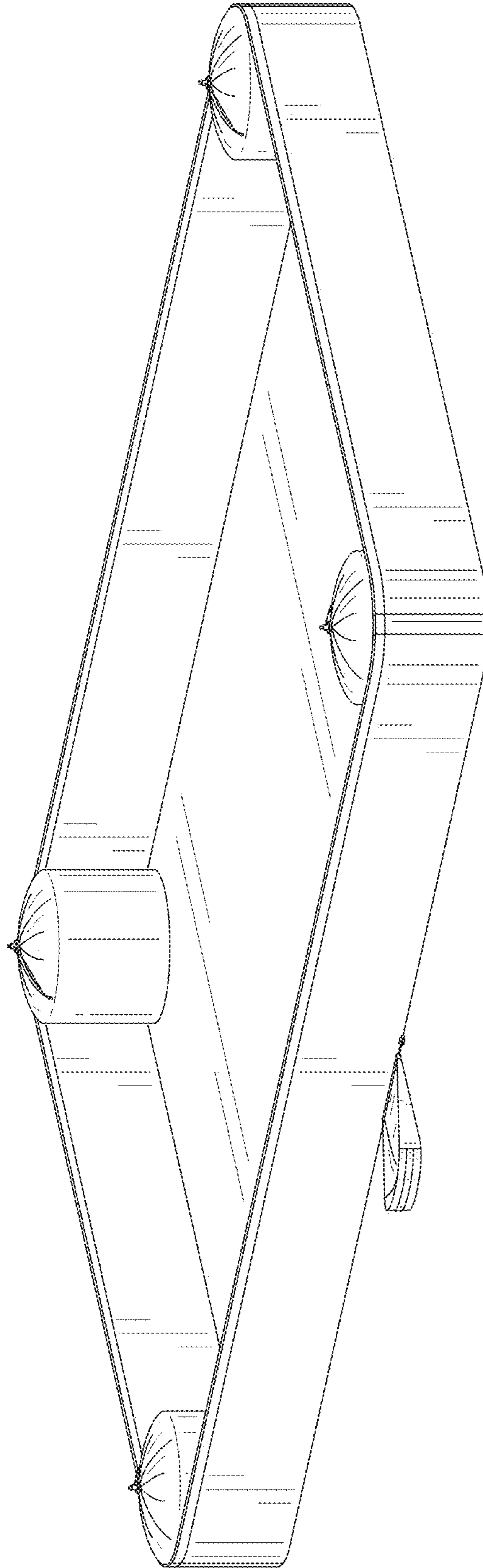

FIG. 1

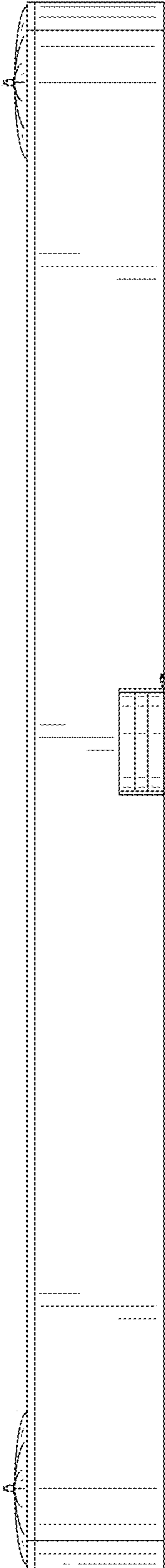

FIG. 2

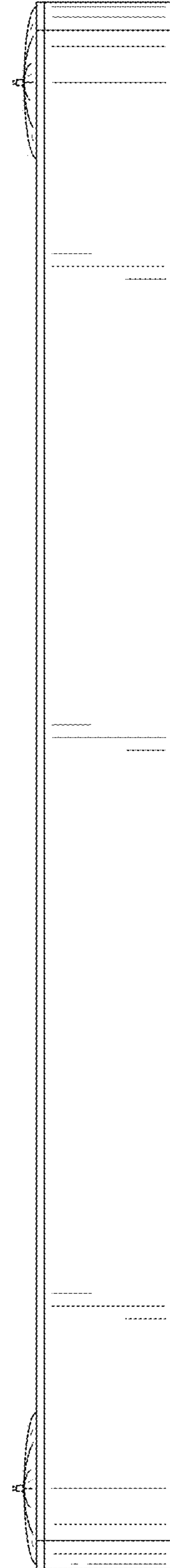

FIG. 3

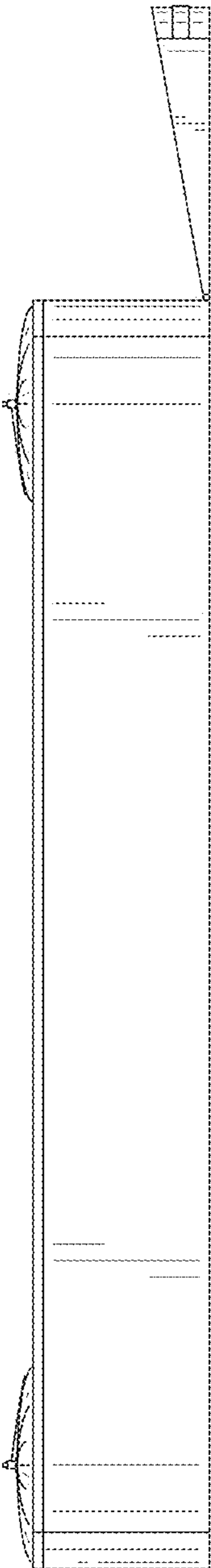

FIG. 4

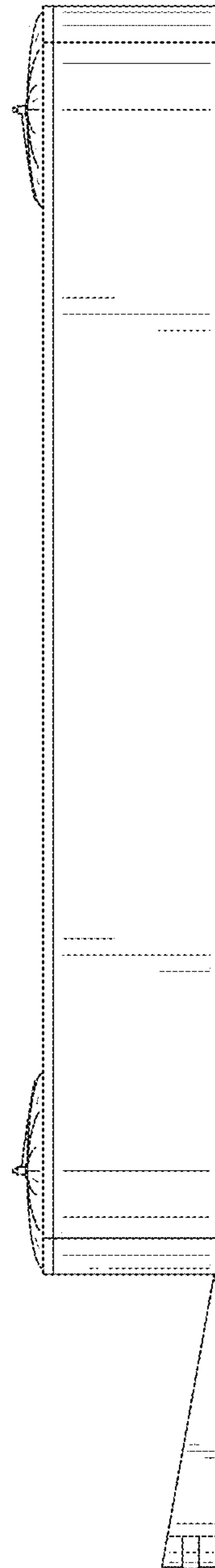

FIG. 5

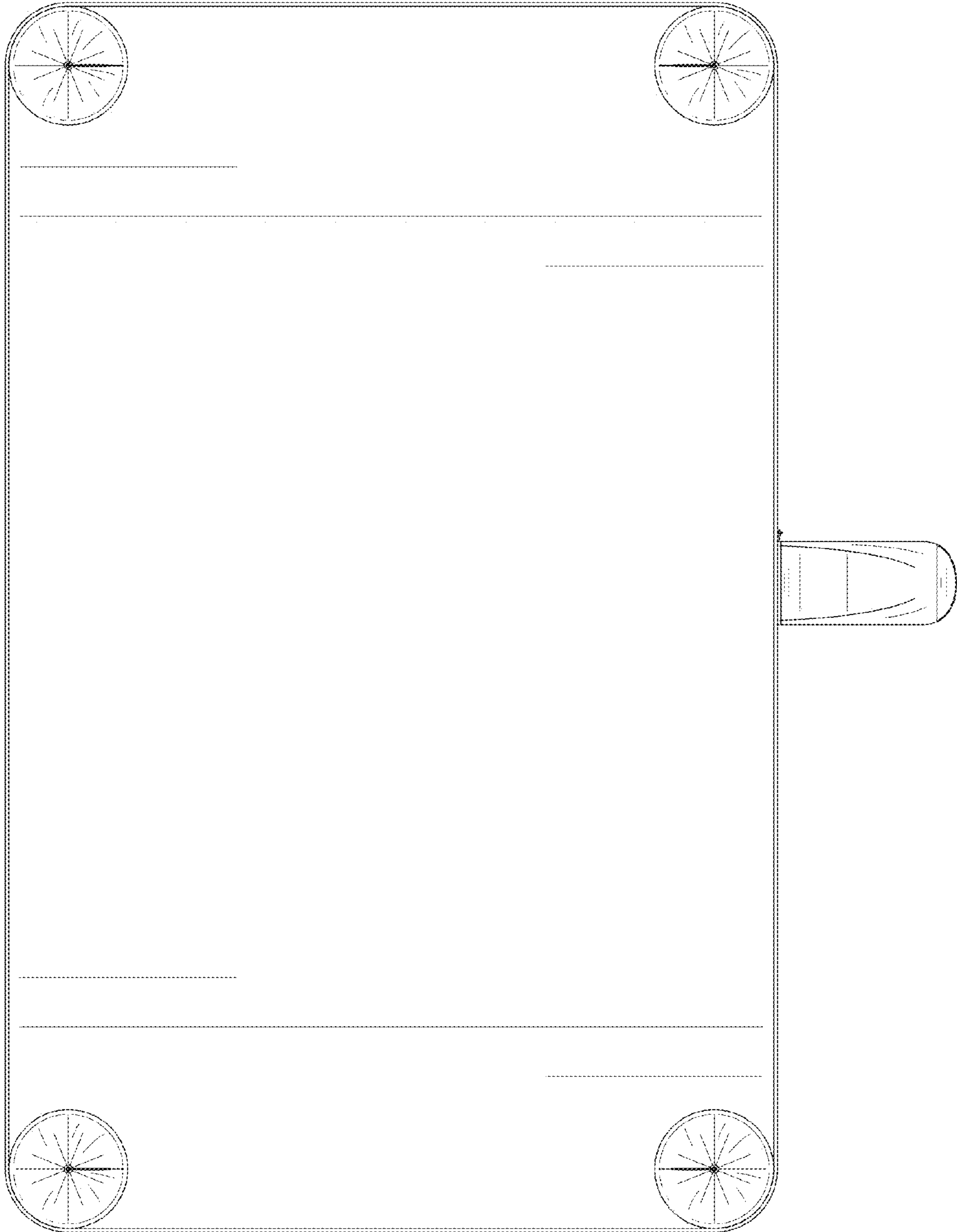

FIG. 6

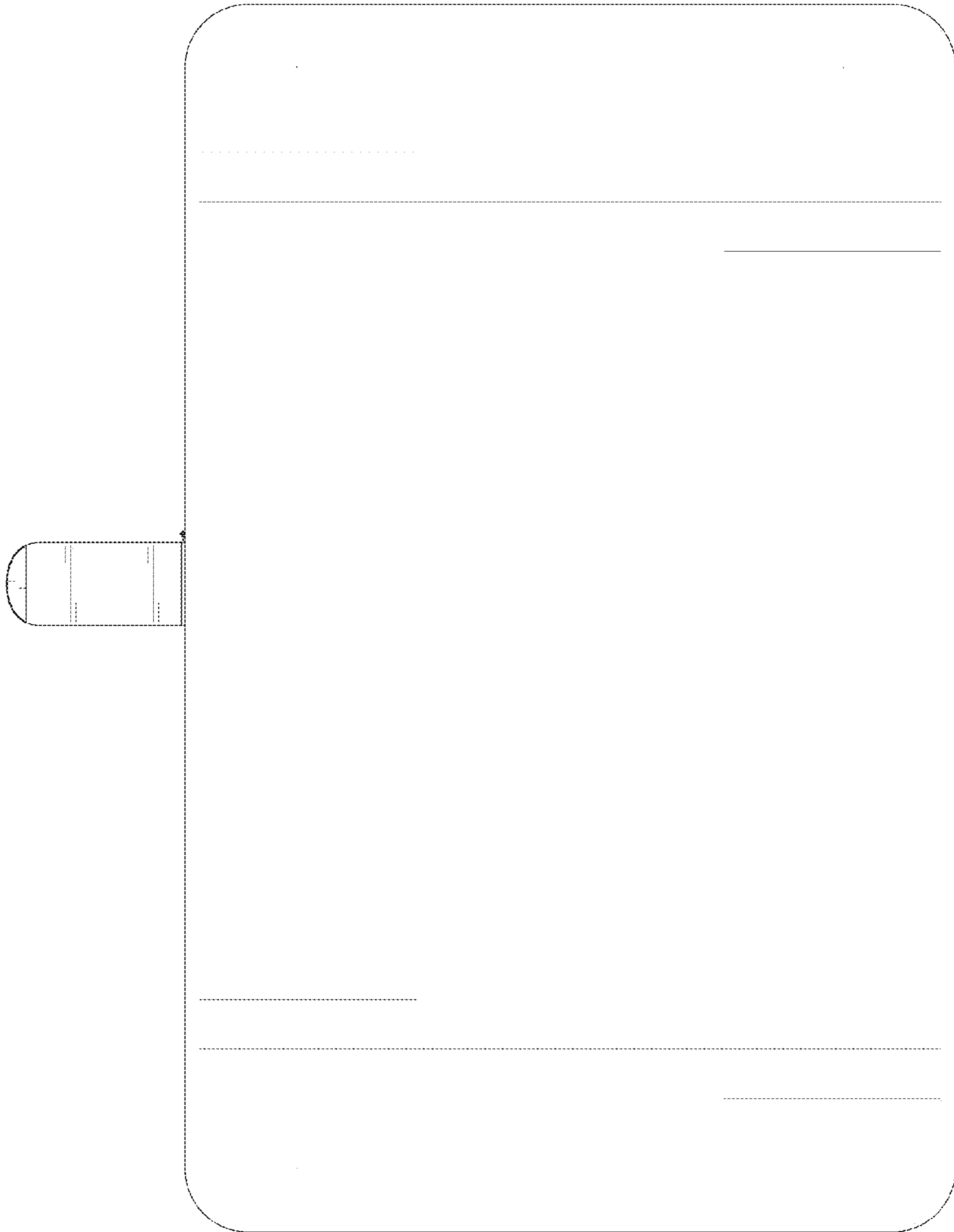

FIG. 7

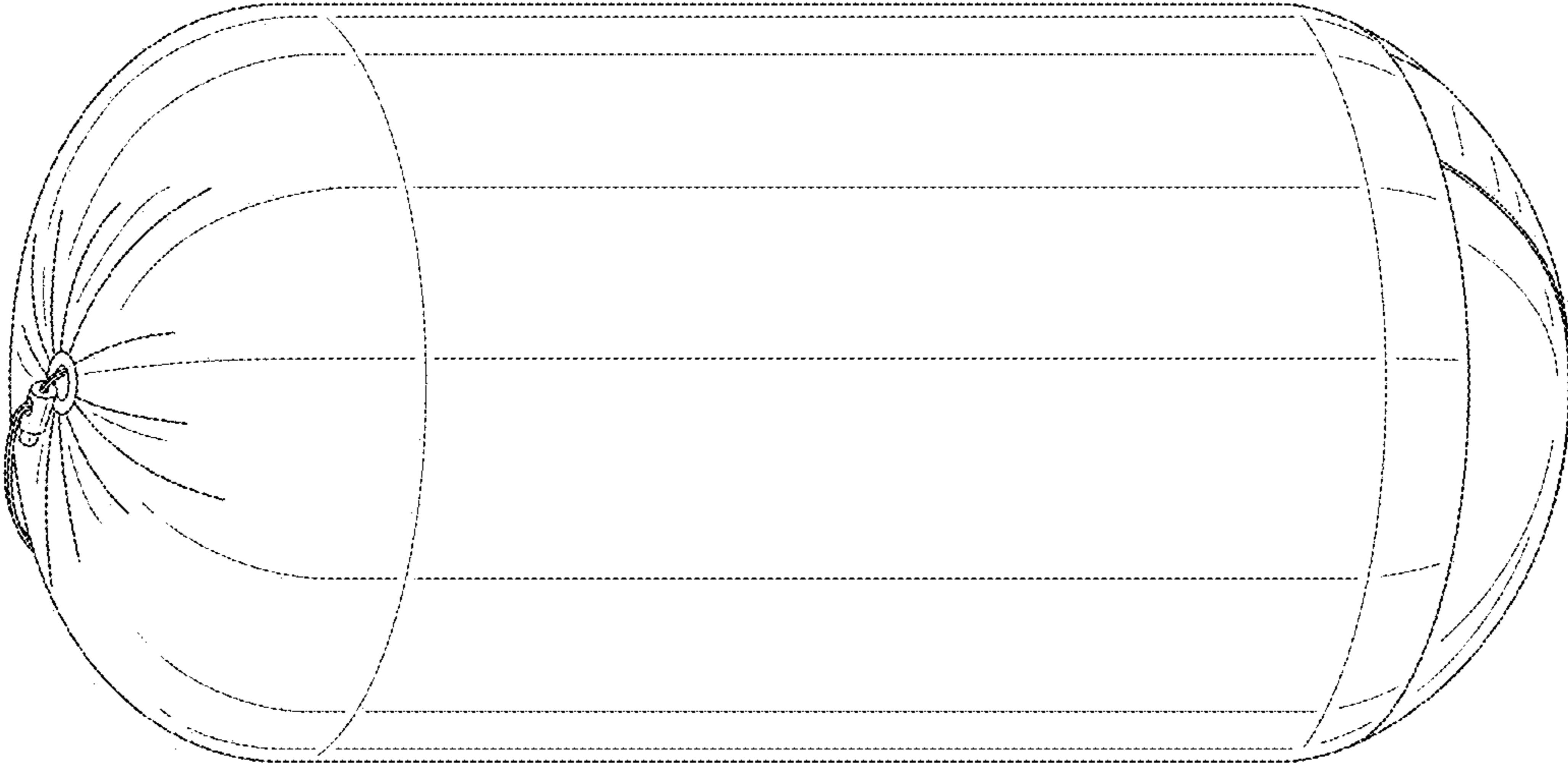

FIG. 8

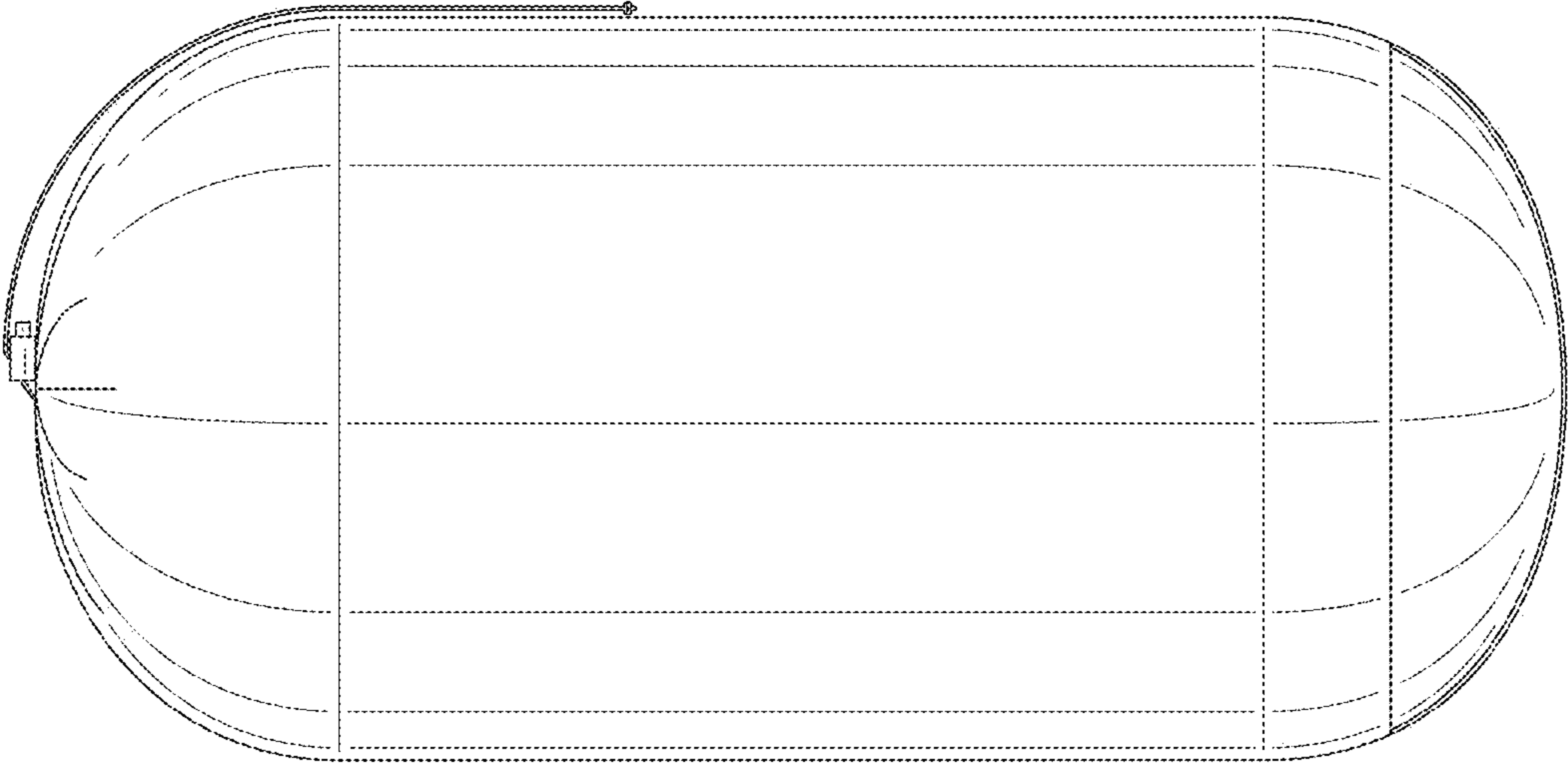

FIG. 10

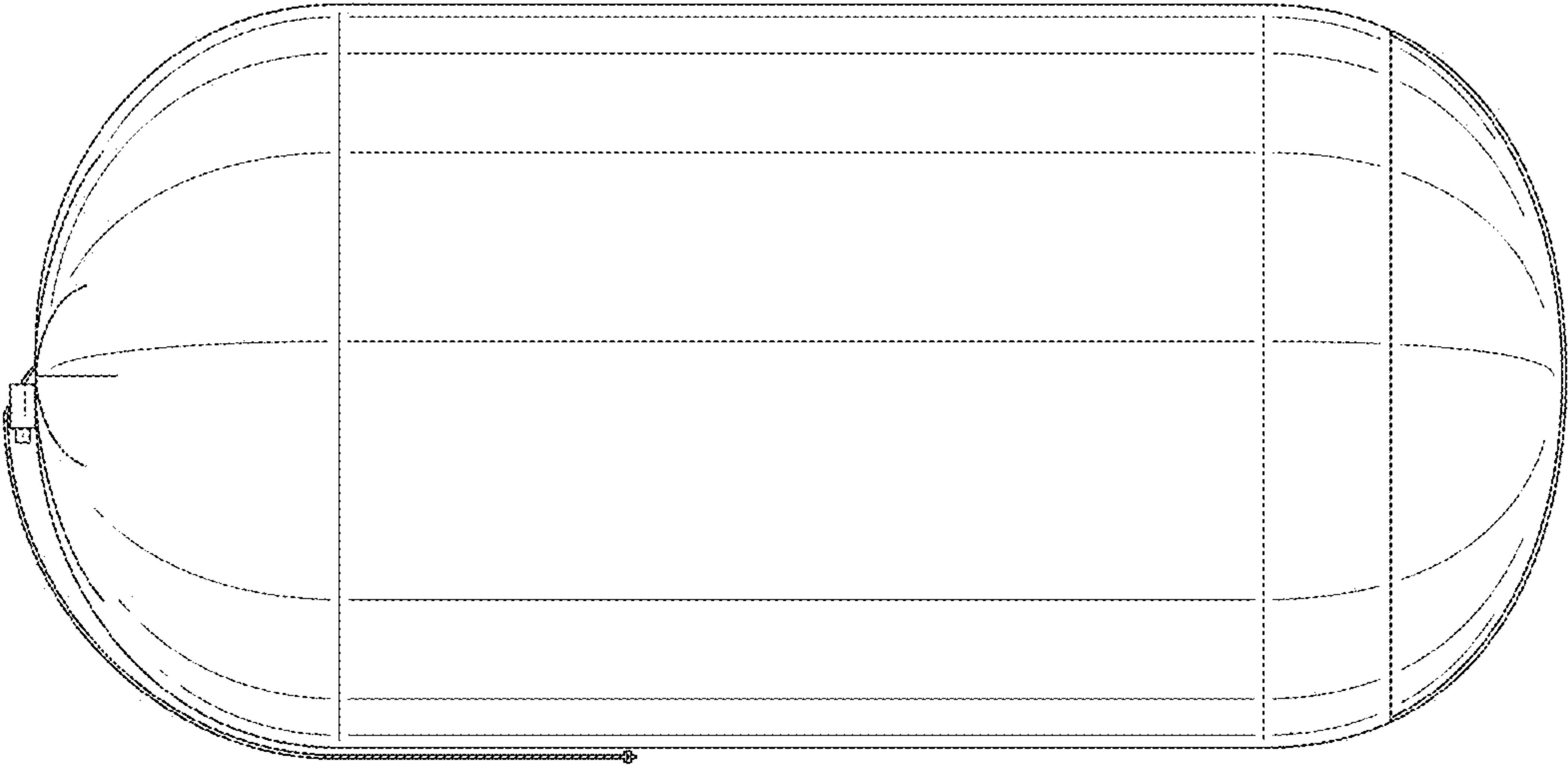

FIG. 9

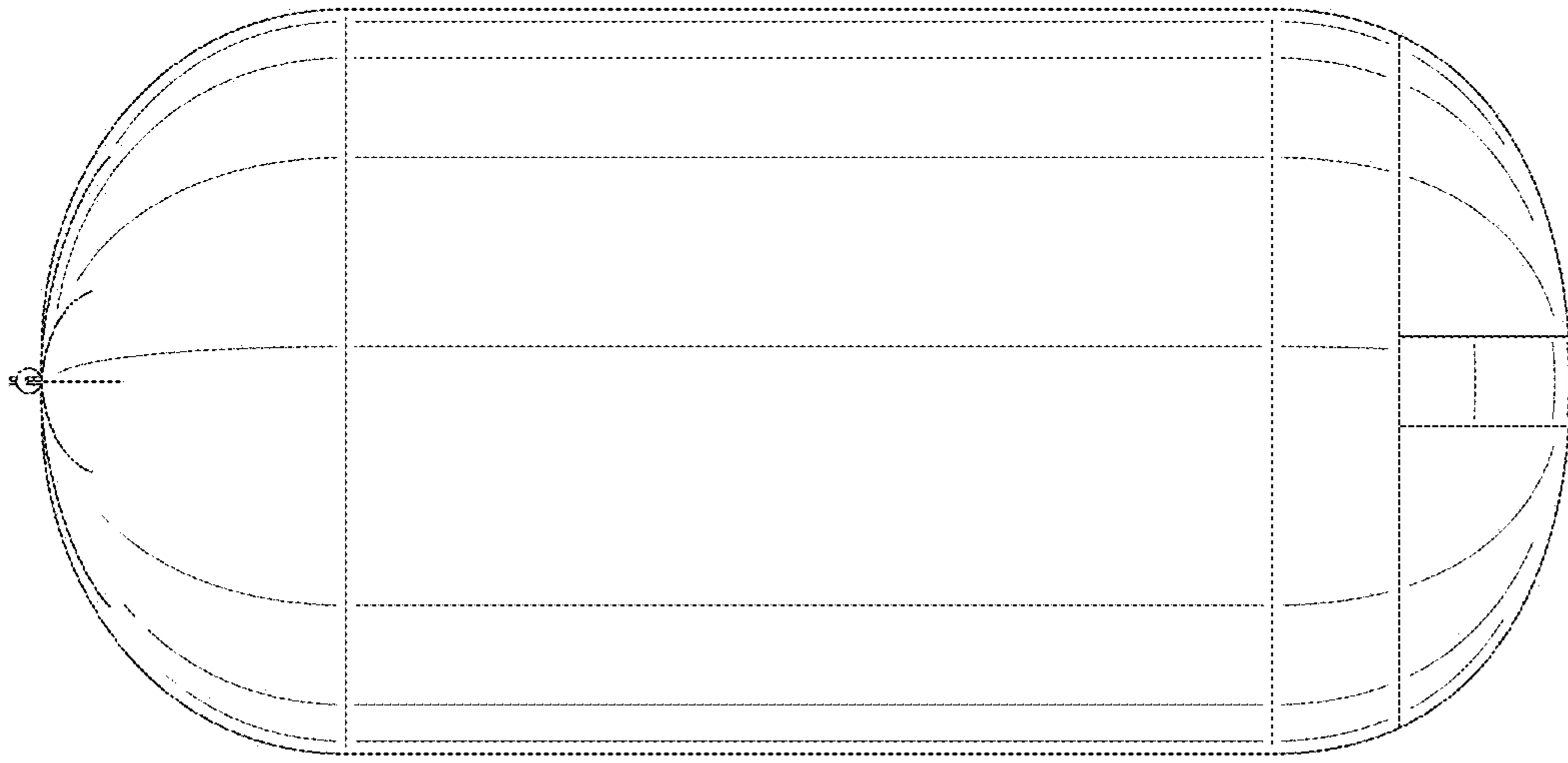

FIG. 11

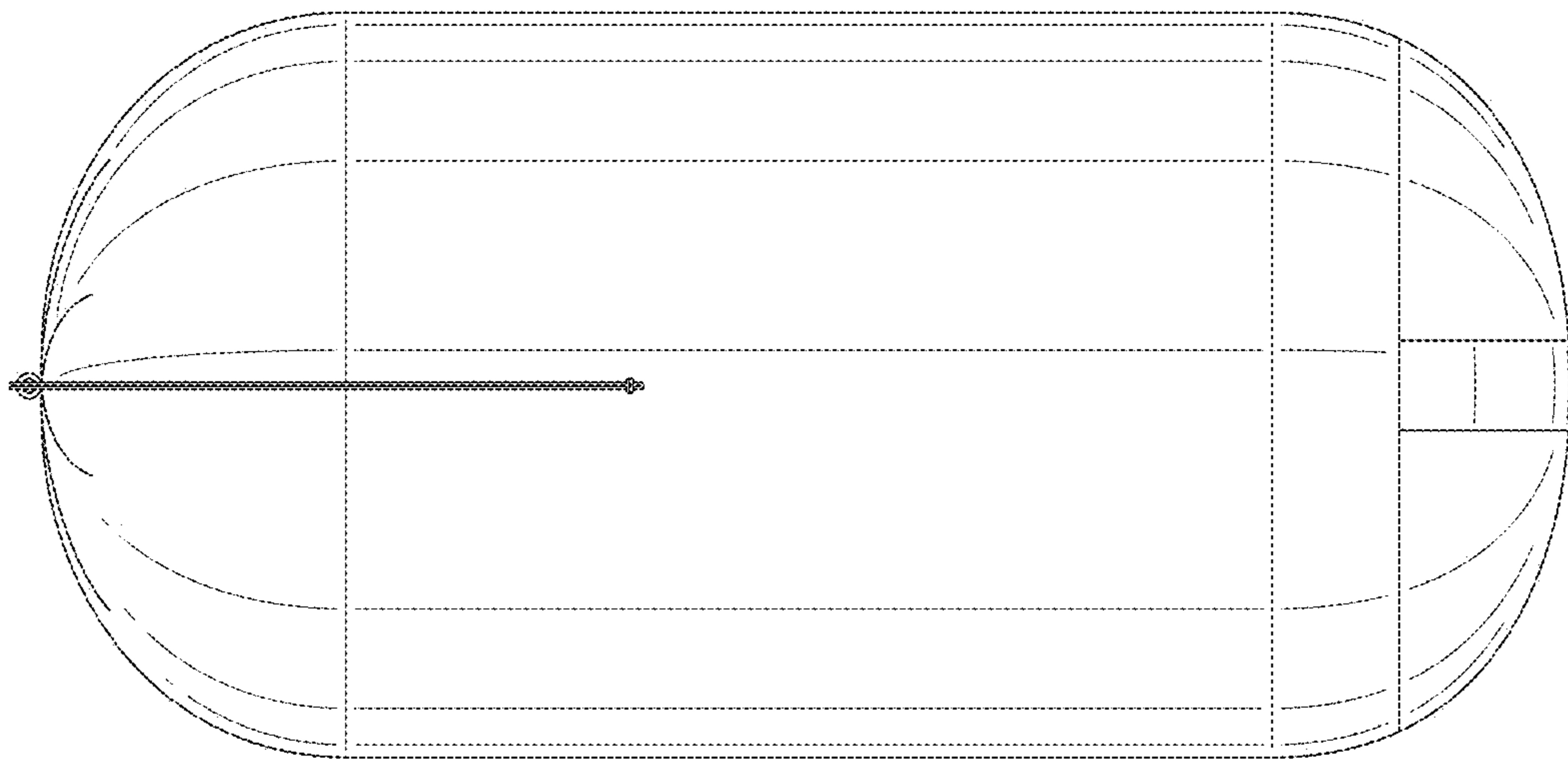

FIG. 12

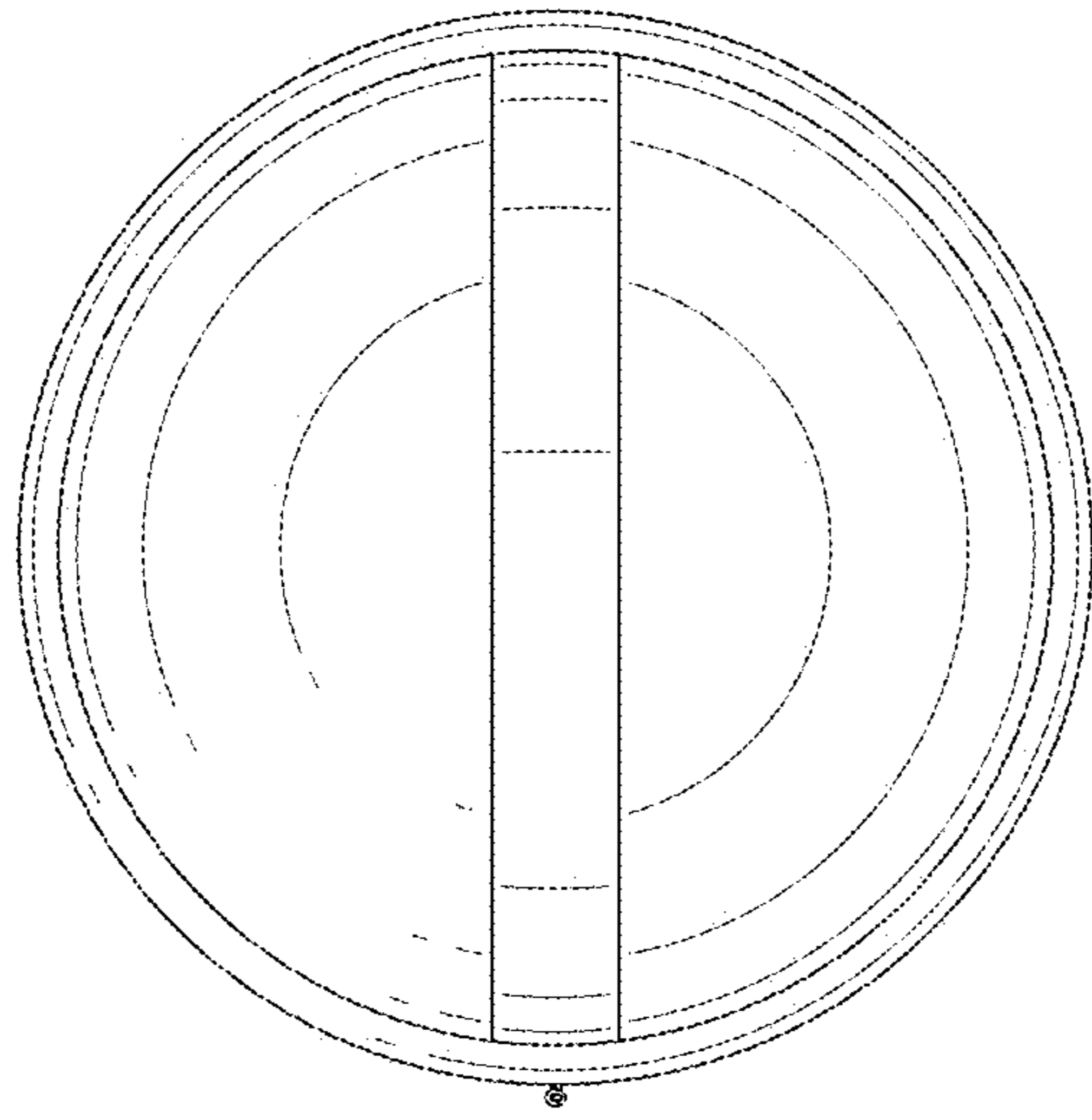

FIG. 14

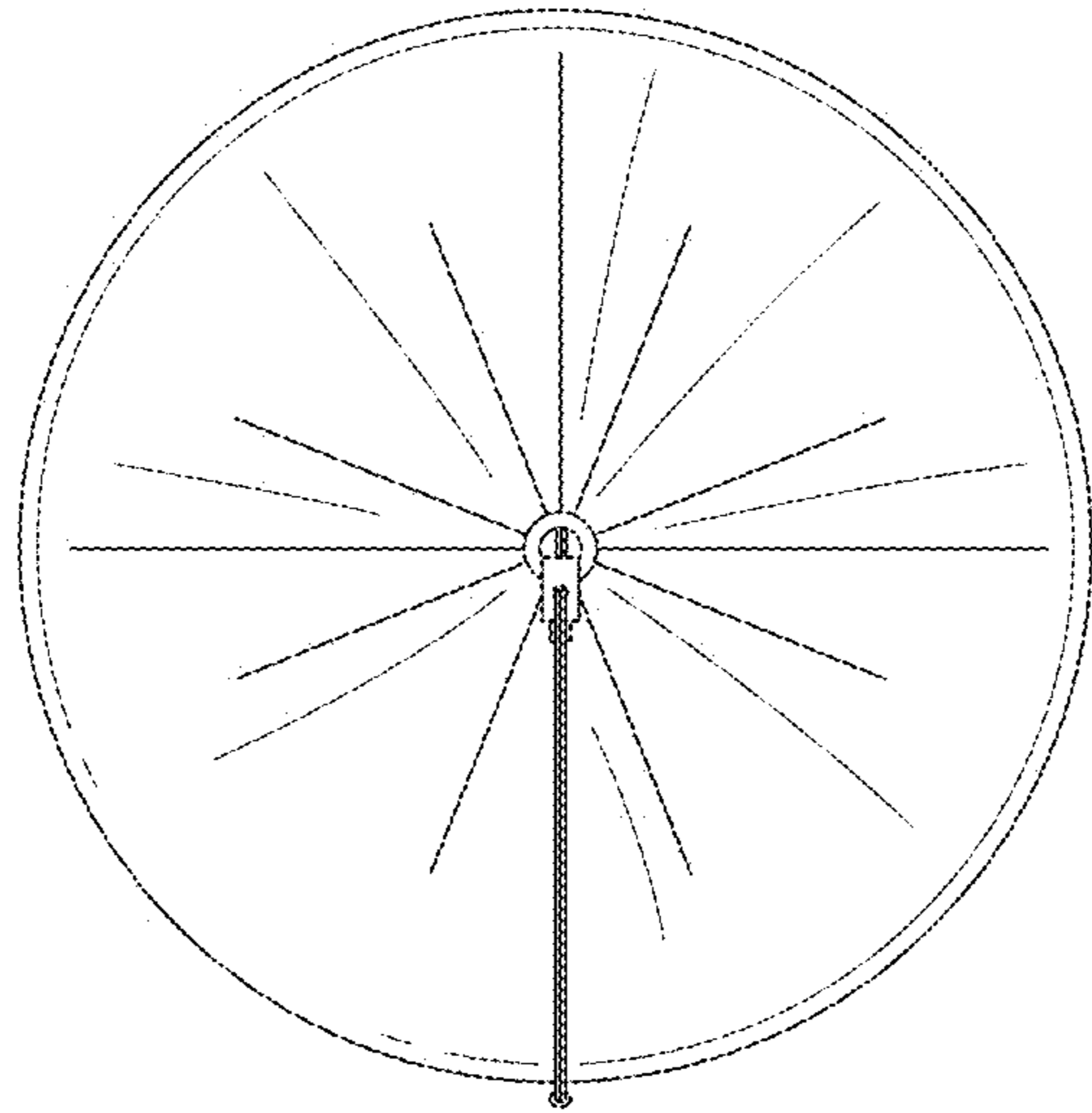

FIG. 13