



US00D973993S

(12) **United States Design Patent** (10) **Patent No.:** **US D973,993 S**
Hunter (45) **Date of Patent:** **** Dec. 27, 2022**

(54) **CART HANDLE COVER**

(71) Applicant: **Katrena Hunter**, Atlanta, GA (US)

(72) Inventor: **Katrena Hunter**, Atlanta, GA (US)

(**) Term: **15 Years**

(21) Appl. No.: **29/746,141**

(22) Filed: **Aug. 12, 2020**

(51) **LOC (13) Cl.** **12-05**

(52) **U.S. Cl.**
USPC **D34/27**

(58) **Field of Classification Search**
USPC D34/27; D6/610, 612; D32/35, 40, 50
CPC ... B62B 3/1452; B62B 3/1436; B62B 3/1448;
B62B 5/069; B62B 5/082; B62B 5/0013
See application file for complete search history.

(56) **References Cited**

U.S. PATENT DOCUMENTS

2,896,339	A *	7/1959	Rabinowitz	A43B 23/28 66/171
D342,262	S *	12/1993	Hester	D14/250
D372,920	S *	8/1996	Bragg	D6/610
D400,541	S *	11/1998	Harrison	D14/250
D447,902	S *	9/2001	Black	D6/610
D500,313	S *	12/2004	Mason	D14/250
D504,256	S *	4/2005	Ritossa	D6/718
D507,143	S *	7/2005	Thrasher	D6/611
D530,245	S *	10/2006	Pettinato	D12/133
7,564,968	B2 *	7/2009	Ayers	H04M 1/19 379/451

(Continued)

OTHER PUBLICATIONS

Ebay.com Aug. 16, 2022, Shopping cart handle cover blue, <https://www.ebay.com/itm/264651518587> (Year: 2022).*

(Continued)

Primary Examiner — Cynthia Ramirez

(74) *Attorney, Agent, or Firm* — The Sladkus Law Group

(57) **CLAIM**

The ornamental design for cart handle cover, as shown and described.

DESCRIPTION

FIG. 1 is a perspective view of a cart handle cover showing a new design;
 FIG. 2 is a front view of the cart handle cover of FIG. 1;
 FIG. 3 is a rear view of the cart handle cover of FIG. 1;
 FIG. 4 is a left side view of the cart handle cover of FIG. 1;
 FIG. 5 is a right side view of the cart handle cover of FIG. 1;
 FIG. 6 is a top view of the cart handle cover of FIG. 1;
 FIG. 7 is a bottom view of the cart handle cover of FIG. 1;
 FIG. 8 is a perspective view of the cart handle cover of FIG. 1 shown in condition of use;
 FIG. 9 is a perspective view of cart handle cover showing a new design;
 FIG. 10 is a front view of the cart handle cover of FIG. 9;
 FIG. 11 is a rear view of the cart handle cover of FIG. 9;
 FIG. 12 is a left side view of the cart handle cover of FIG. 9;
 FIG. 13 is a right side view of the cart handle cover of FIG. 9;
 FIG. 14 is a top view of the cart handle cover of FIG. 9;
 FIG. 15 is a bottom view of the cart handle cover of FIG. 9;
 and,
 FIG. 16 is a perspective view of the cart handle cover of FIG. 9 shown in condition of use.

The broken lines in the figures are for the purpose of illustrating portions of the cart handle cover that form no part of the claimed design. The cart shown in dash-dot broken lines in FIGS. 8 and 16 show environment and form no part of the claimed design.

1 Claim, 10 Drawing Sheets

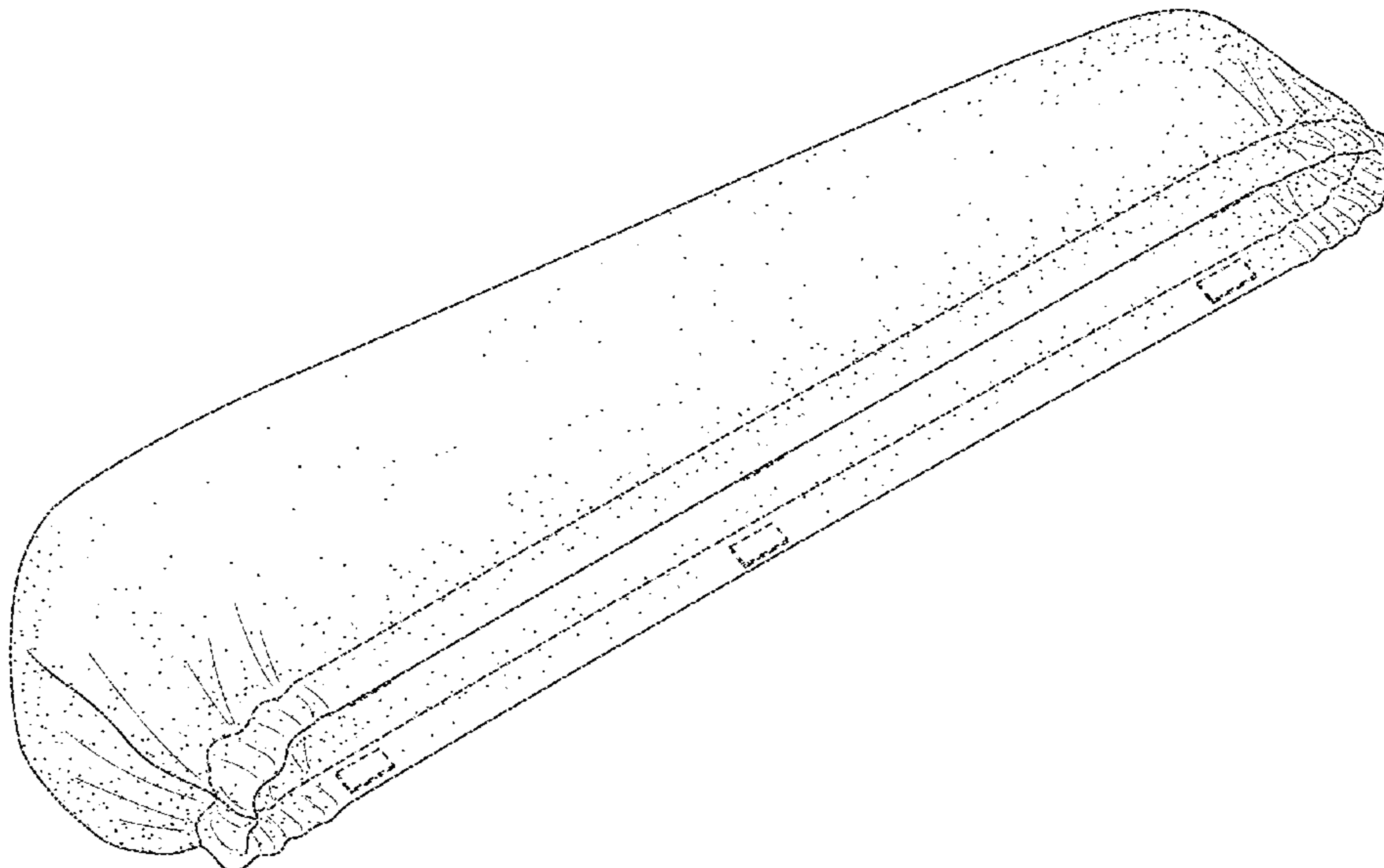

(56)

References Cited

U.S. PATENT DOCUMENTS

D610,854 S *	3/2010	Siklosi	D6/611
8,109,524 B1 *	2/2012	Toohey	B62B 5/069 297/256.17
D675,857 S *	2/2013	Eshom	D6/610
D732,260 S *	6/2015	Wiley	D34/27
D860,686 S *	9/2019	Lindberg	D6/611
D879,511 S *	3/2020	Maebe	D6/611
D911,251 S *	2/2021	Wheeler	D12/401
11,130,514 B1 *	9/2021	Picchi	B62B 5/069
2011/0148056 A1 *	6/2011	Niernberger	B62B 5/069 280/33.992
2016/0113412 A1 *	4/2016	Clark	A47C 31/11 297/227

OTHER PUBLICATIONS

Amazon.com Aug. 16, 2022, VanDuck 100% cotton terry mop pad, <https://www.amazon.com/VanDuck-100-Cotton-Terry-12-Pack/dp/B079KY8TKJ> (Year: 2022).*

Grainger.com Aug. 16, 2022, Mop Cover: Isolator cleaning elastic cover, <https://www.grainger.com/product/6ENZ3> (Year: 2022).*

Discount.com Aug. 16, 2022, SH-Wipe terry cloth covers, <https://www.discountcleaningproducts.com/Sh-Wipe-Terry-Cloth-Covers-for-15-p/22000> (Year: 2022).*

* cited by examiner

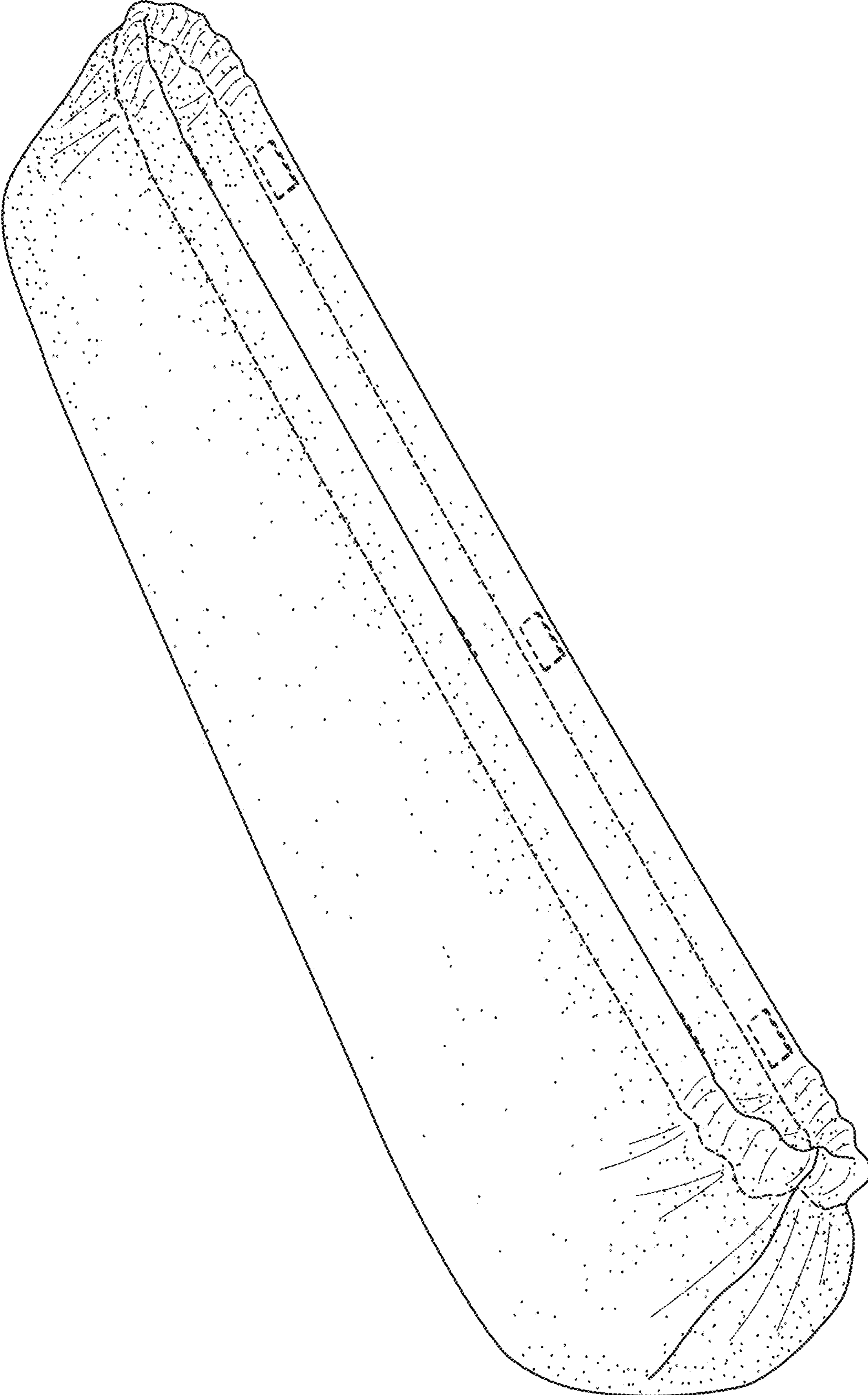

FIG. 1

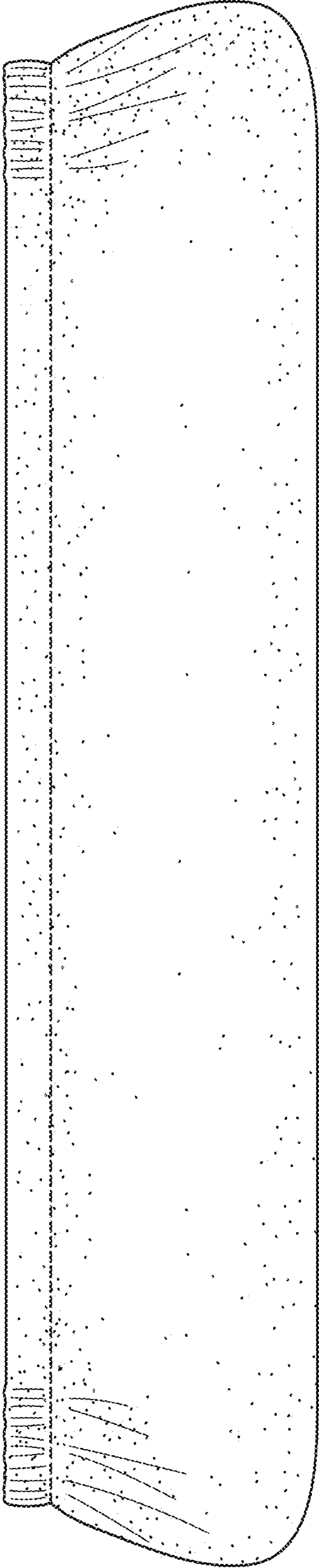

FIG. 2

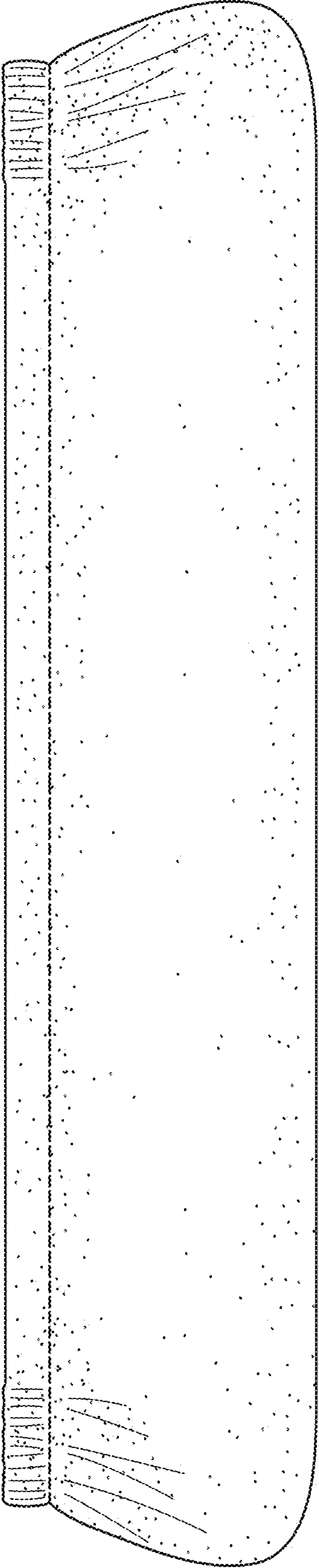

FIG. 3

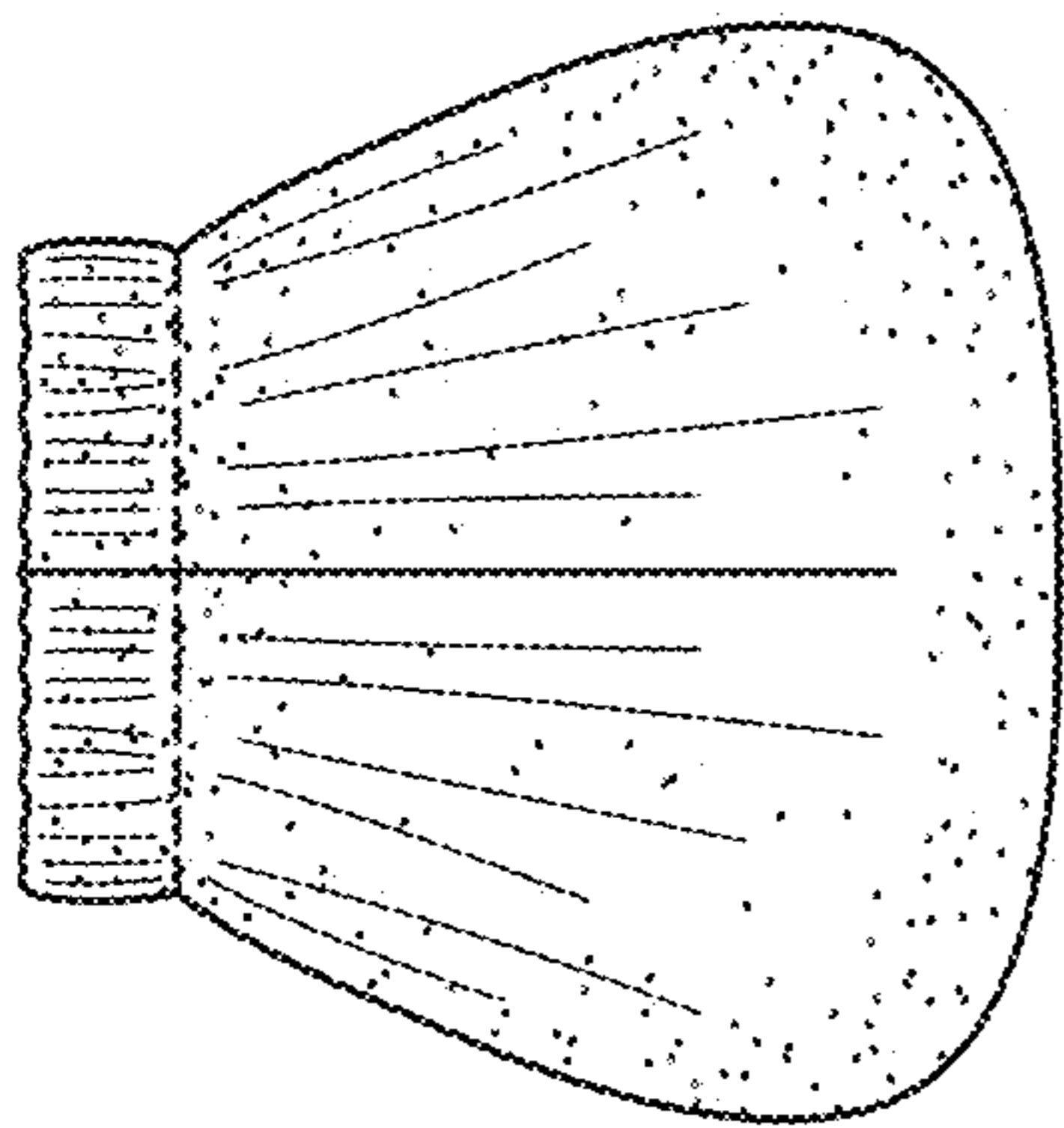

FIG. 4

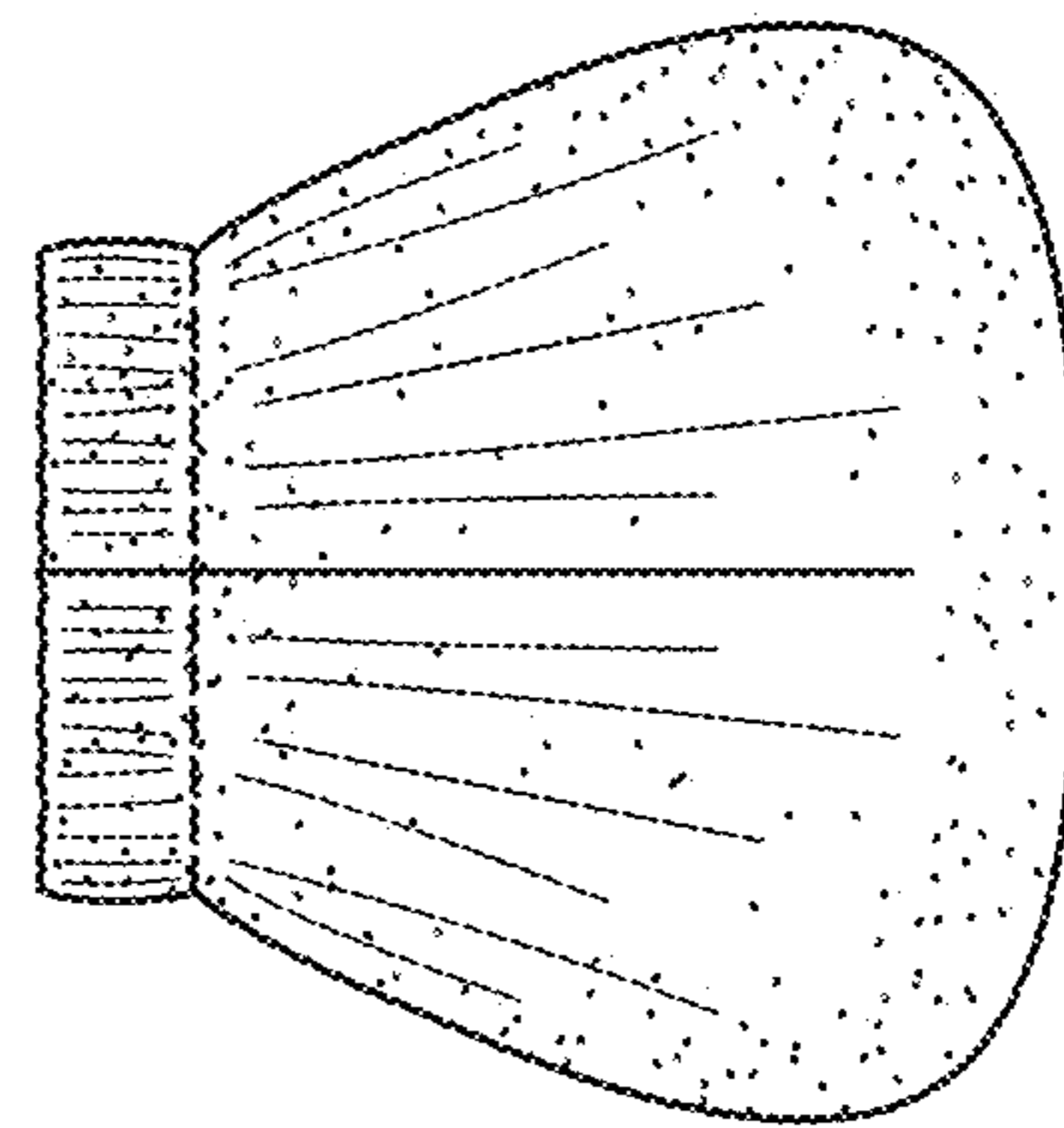

FIG. 5

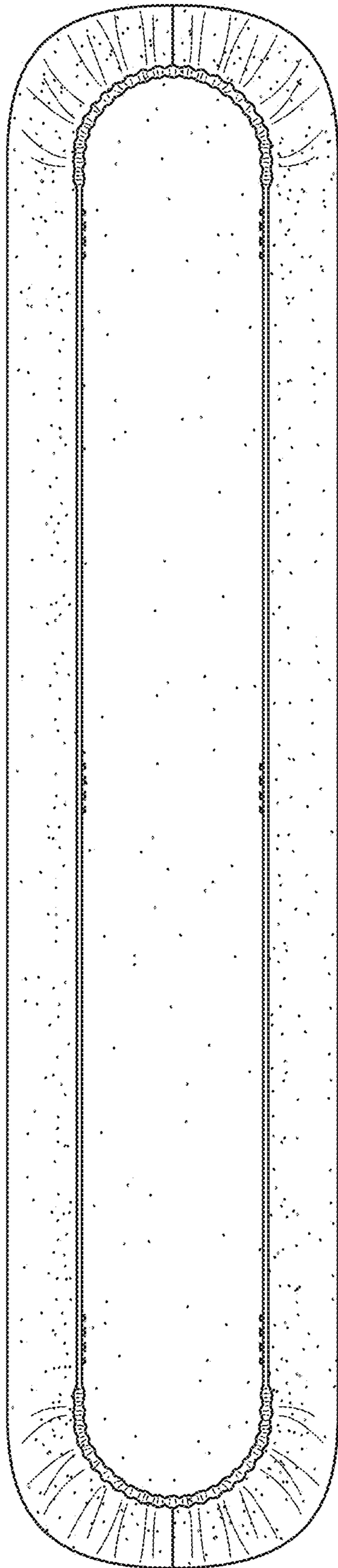

FIG. 6

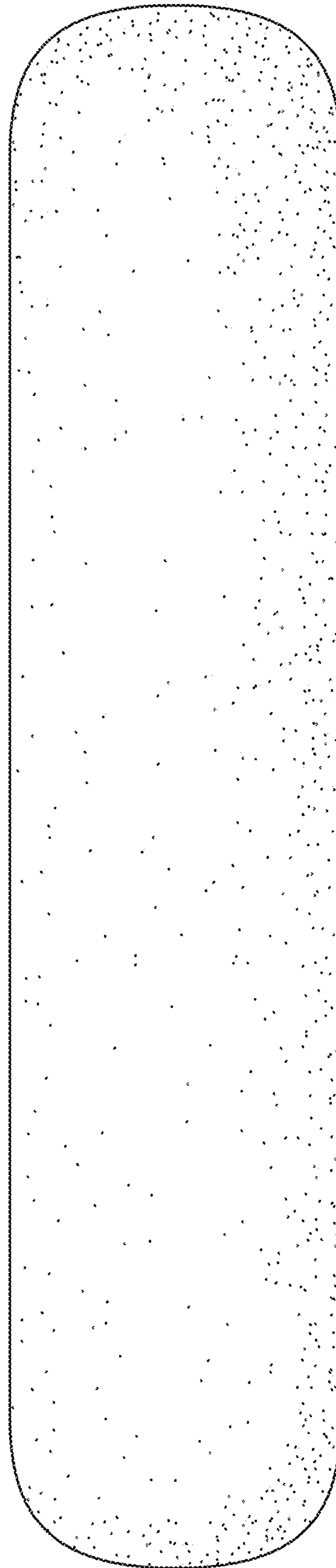

FIG. 7

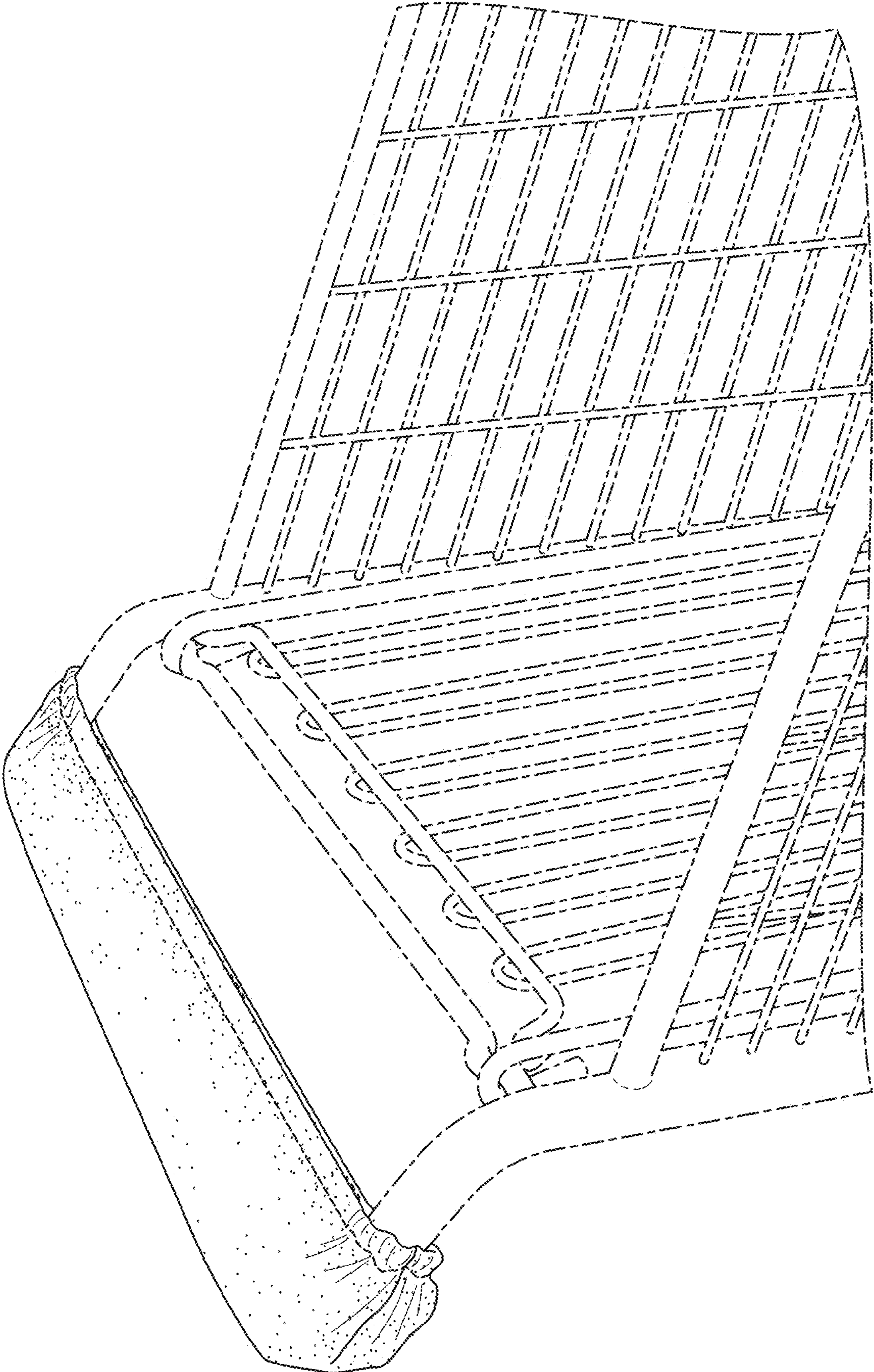

FIG. 8

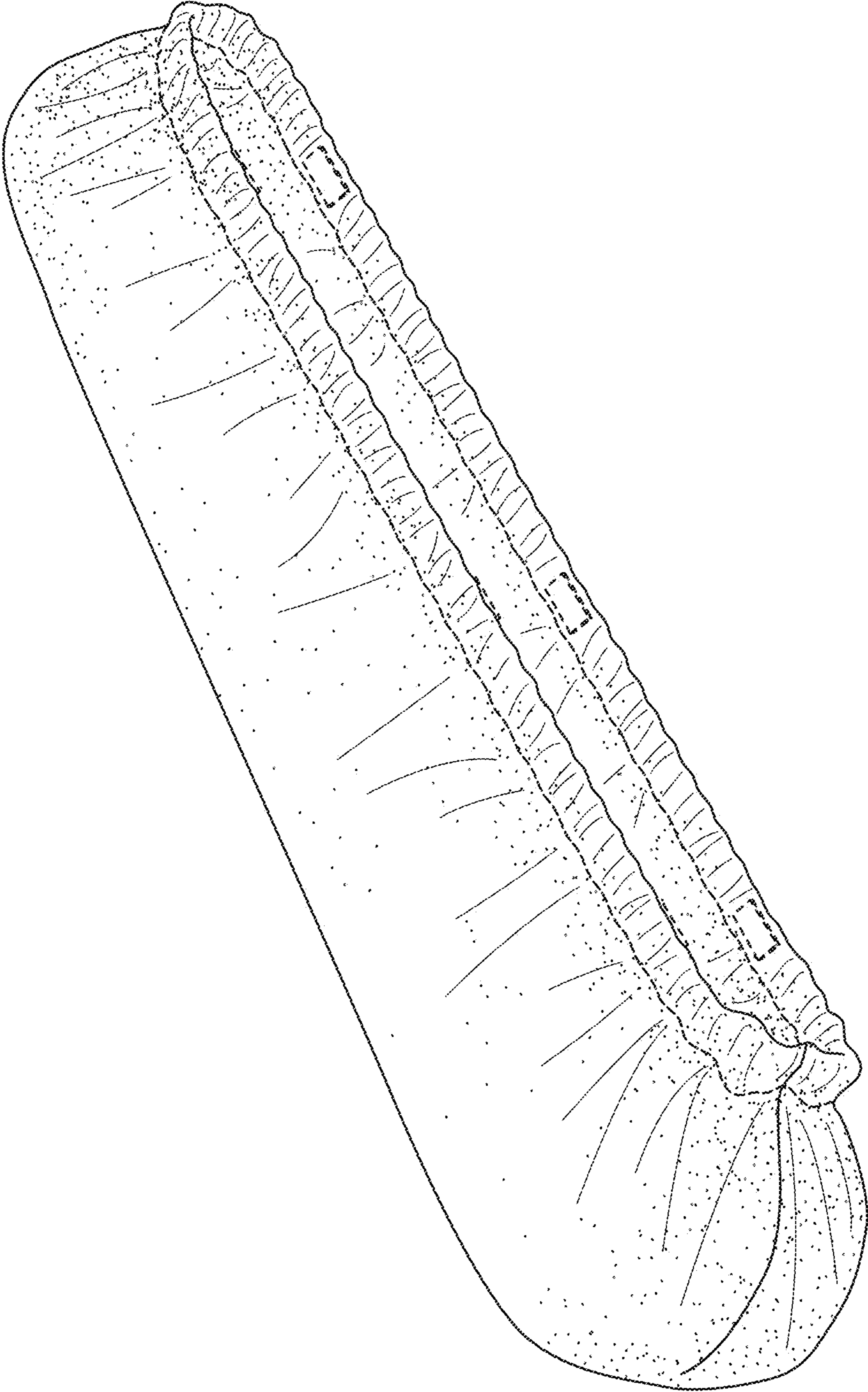

FIG. 9

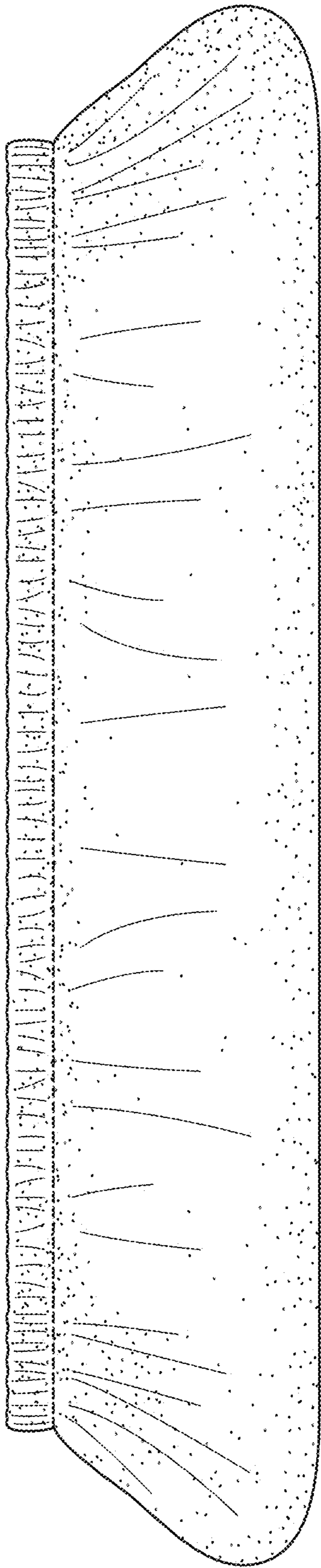

FIG. 10



FIG. 11

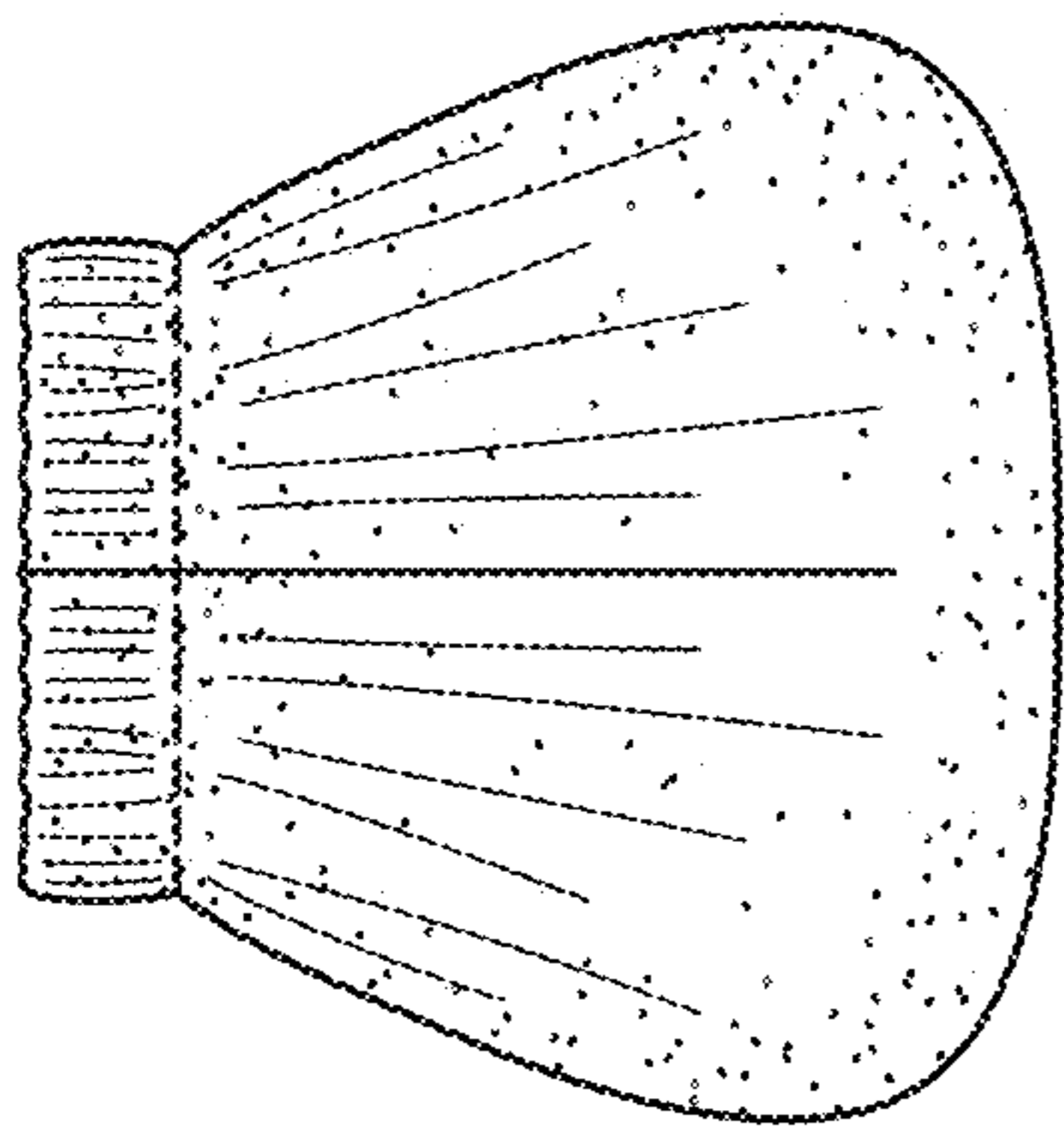

FIG. 12

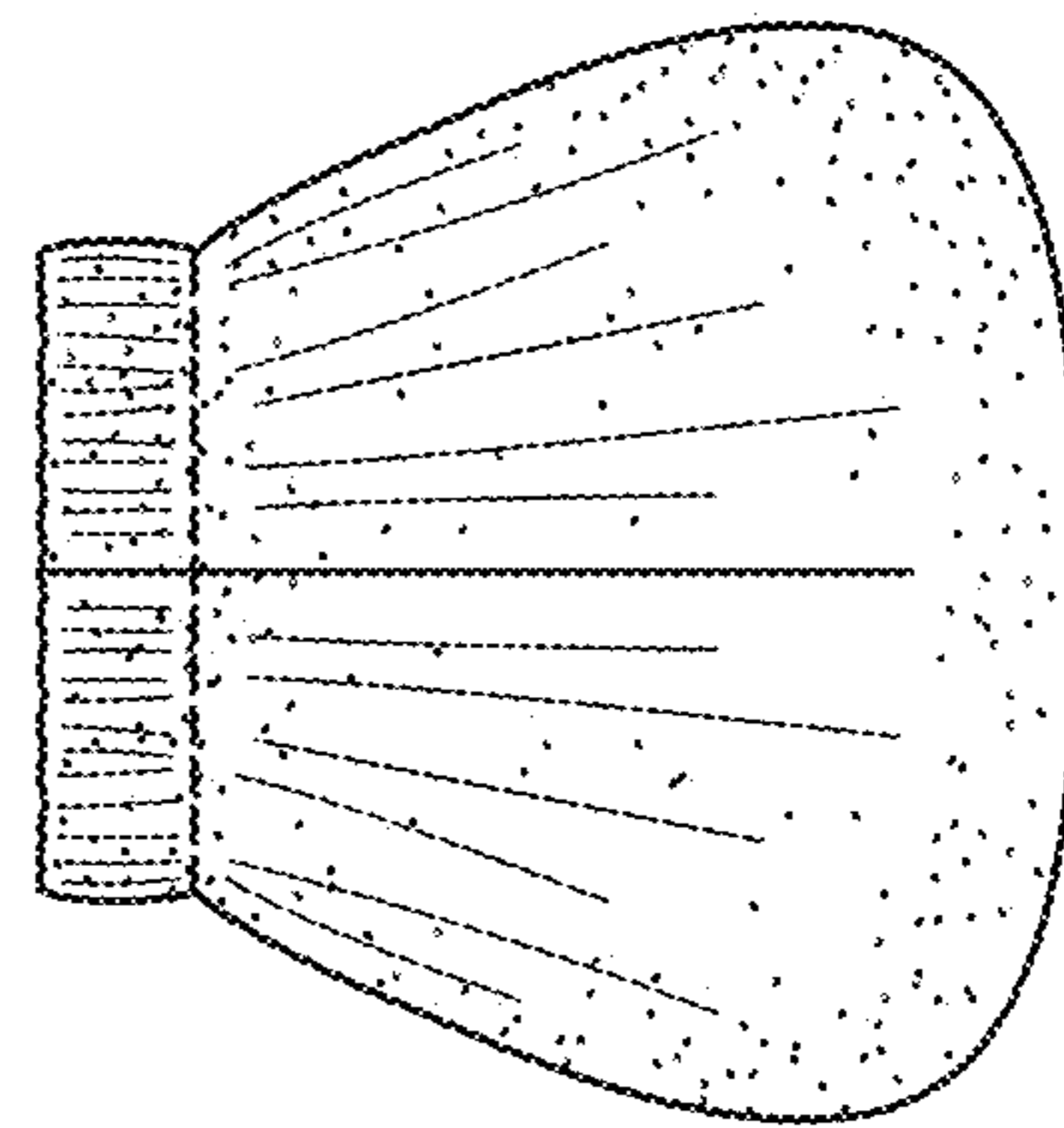

FIG. 13

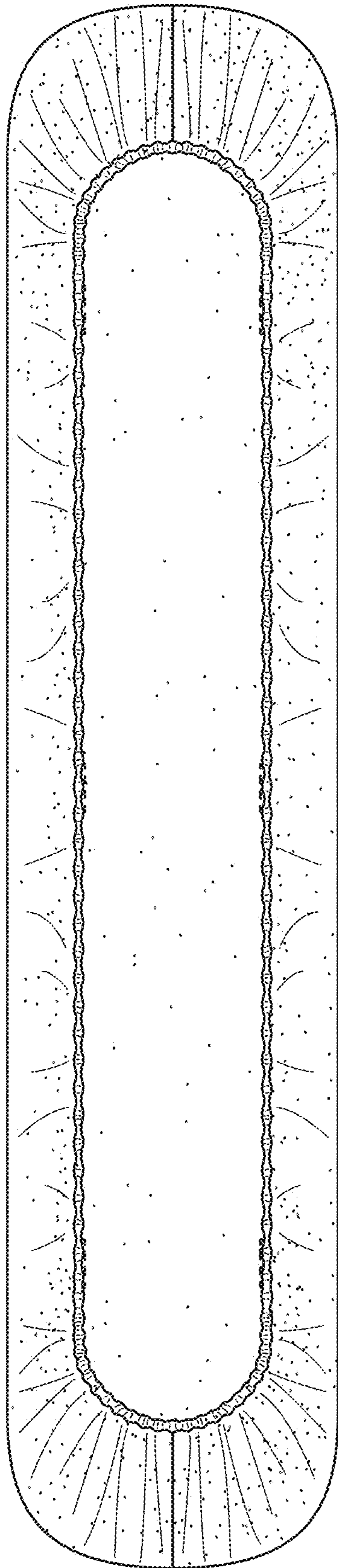

FIG. 14

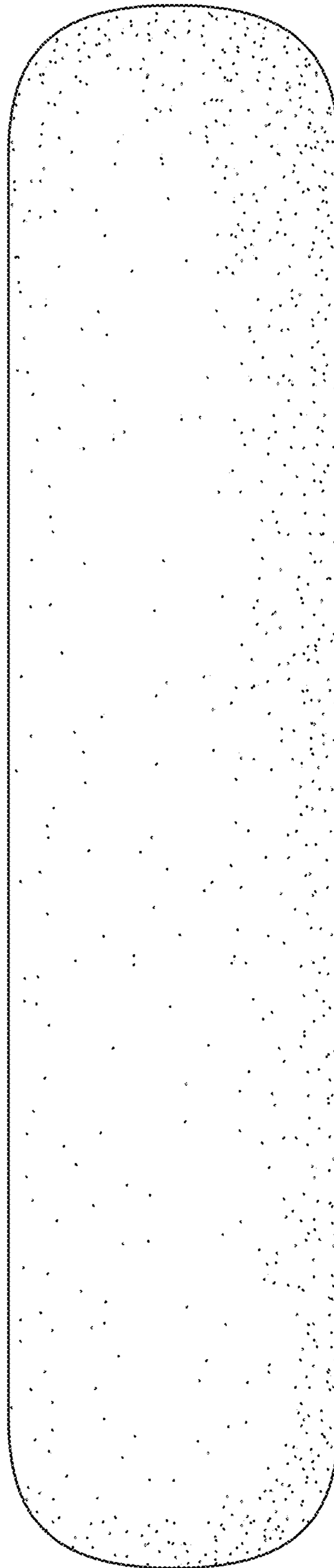

FIG. 15

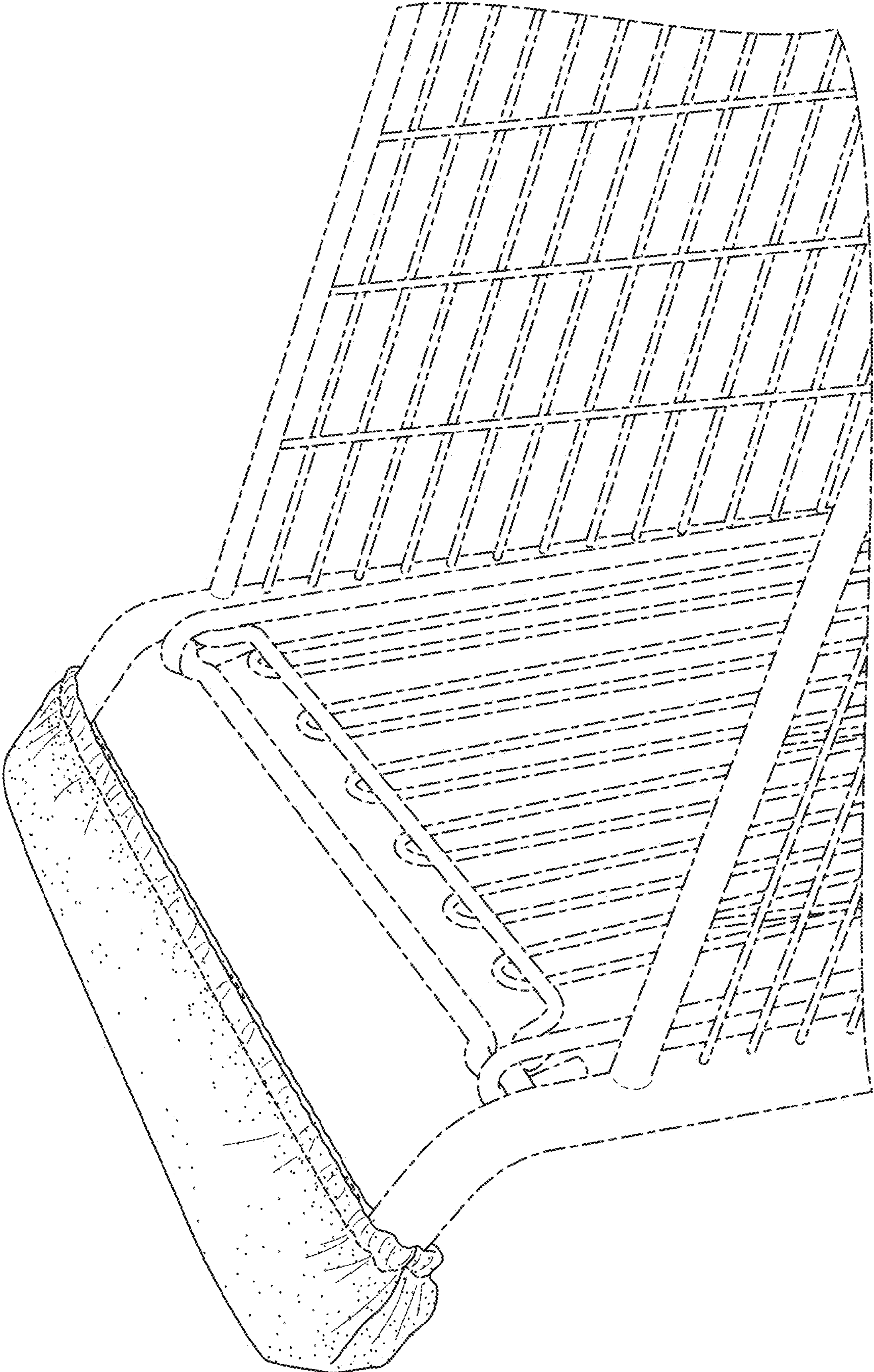

FIG. 16