



US00D973967S

(12) **United States Design Patent**  
**Geisinsky**

(10) **Patent No.:** **US D973,967 S**

(45) **Date of Patent:** **\*\* Dec. 27, 2022**

(54) **WIG GRIP BAND**

(71) Applicant: **NG Imports, Inc.**, Signal Hill, CA  
(US)

(72) Inventor: **Yehudis Geisinsky**, Long Beach, CA  
(US)

(73) Assignee: **NG Imports, LLC**, Signal Hill, CA  
(US)

(\*\*) Term: **15 Years**

(21) Appl. No.: **29/816,316**

(22) Filed: **Nov. 20, 2021**

**Related U.S. Application Data**

(62) Division of application No. 29/760,459, filed on Dec. 1, 2020, now Pat. No. Des. 939,146.

(51) **LOC (13) Cl.** ..... **28-04**

(52) **U.S. Cl.**  
USPC ..... **D28/93**

(58) **Field of Classification Search**  
USPC ..... D28/92, 93

(Continued)

(56) **References Cited**

**U.S. PATENT DOCUMENTS**

1,671,415 A 5/1928 Eckert  
D365,918 S 1/1996 Izegbu et al.

(Continued)

**FOREIGN PATENT DOCUMENTS**

CN 303113653 S 2/2015  
CN 305106180 S 4/2019

(Continued)

**OTHER PUBLICATIONS**

Title: Wigrip; URL: <https://rhythmwigs.com/wigs/wig-band-wigrip/>; Accessed date: Feb. 5, 2021.

(Continued)

*Primary Examiner* — Zenia I Bennett

(74) *Attorney, Agent, or Firm* — Lance M. Pritikin

(57) **CLAIM**

The ornamental design for a wig grip band, as shown and described.

**DESCRIPTION**

FIG. 1 is a front perspective view of a first embodiment of a wig grip band, showing my new design; FIG. 2 is a front elevational view thereof; FIG. 3 is a rear elevational view thereof; FIG. 4 is a left side elevational view thereof; FIG. 5 is a right side elevational view thereof; FIG. 6 is a top plan view thereof; FIG. 7 is a bottom plan view thereof; FIG. 8 is a further front perspective view thereof, wherein the wig grip band is shown deployed on the head of a wearer; FIG. 9 is a further front view thereof, wherein the wig grip band is shown deployed on the head of a wearer; FIG. 10 is a further rear view thereof, wherein the wig grip band is shown deployed on the head of a wearer; FIG. 11 is a further left side view thereof, wherein the wig grip band is shown deployed on the head of a wearer; FIG. 12 is a further right side view thereof, wherein the wig grip band is shown deployed on the head of a wearer; FIG. 13 is a further top view thereof, wherein the wig grip band is shown deployed on the head of a wearer; FIG. 14 is a further bottom view thereof, wherein the wig grip band is shown deployed on the head of a wearer; FIG. 15 is a front perspective view of a second embodiment of a wig grip band, showing my new design; FIG. 16 is a front elevational view thereof; FIG. 17 is a rear elevational view thereof; FIG. 18 is a left side elevational view thereof; FIG. 19 is a right side elevational view thereof; FIG. 20 is a top plan view thereof; FIG. 21 is a bottom plan view thereof; FIG. 22 is a further front perspective view thereof, wherein the wig grip band is shown deployed on the head of a wearer; FIG. 23 is a further front view thereof, wherein the wig grip band is shown deployed on the head of a wearer;

(Continued)

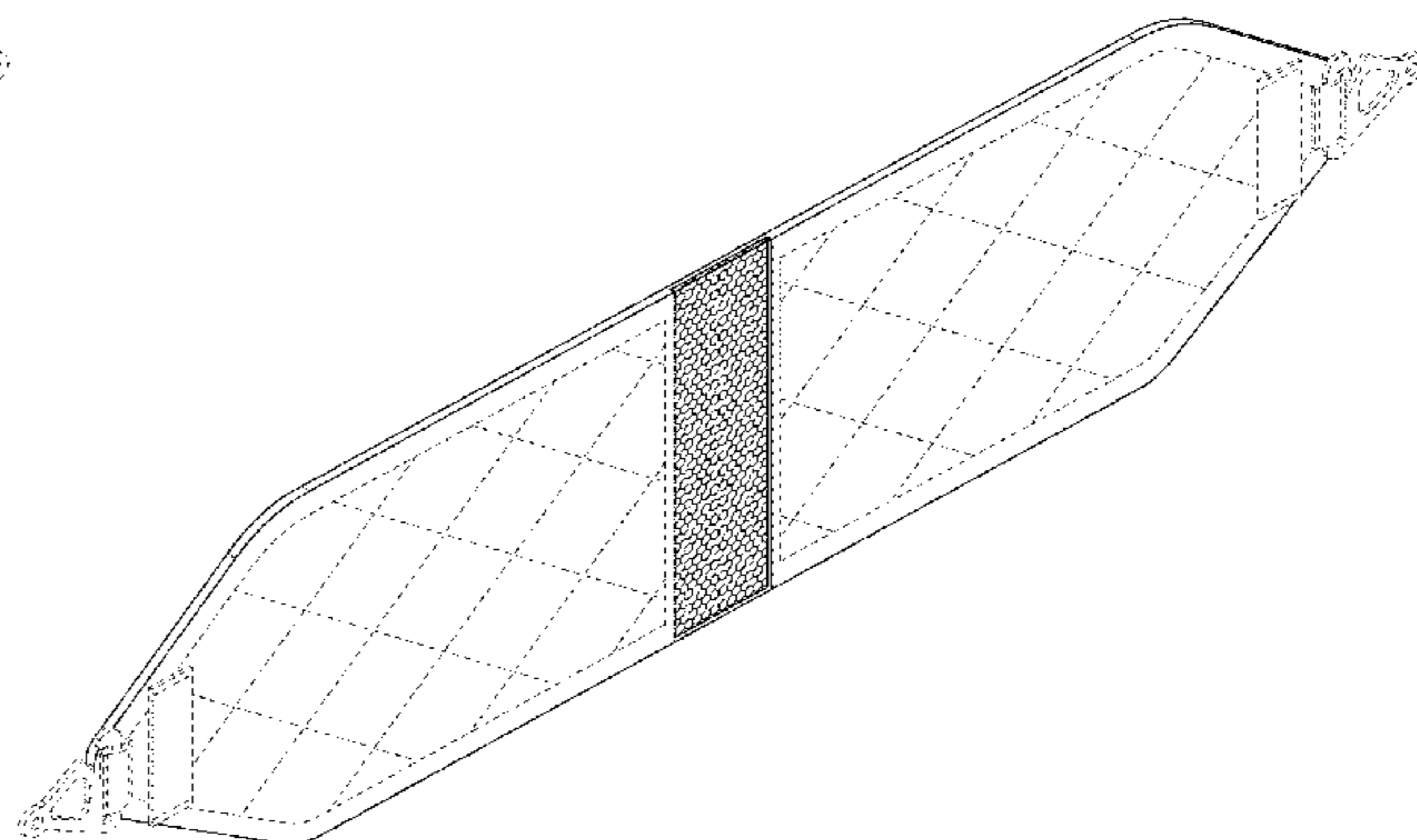
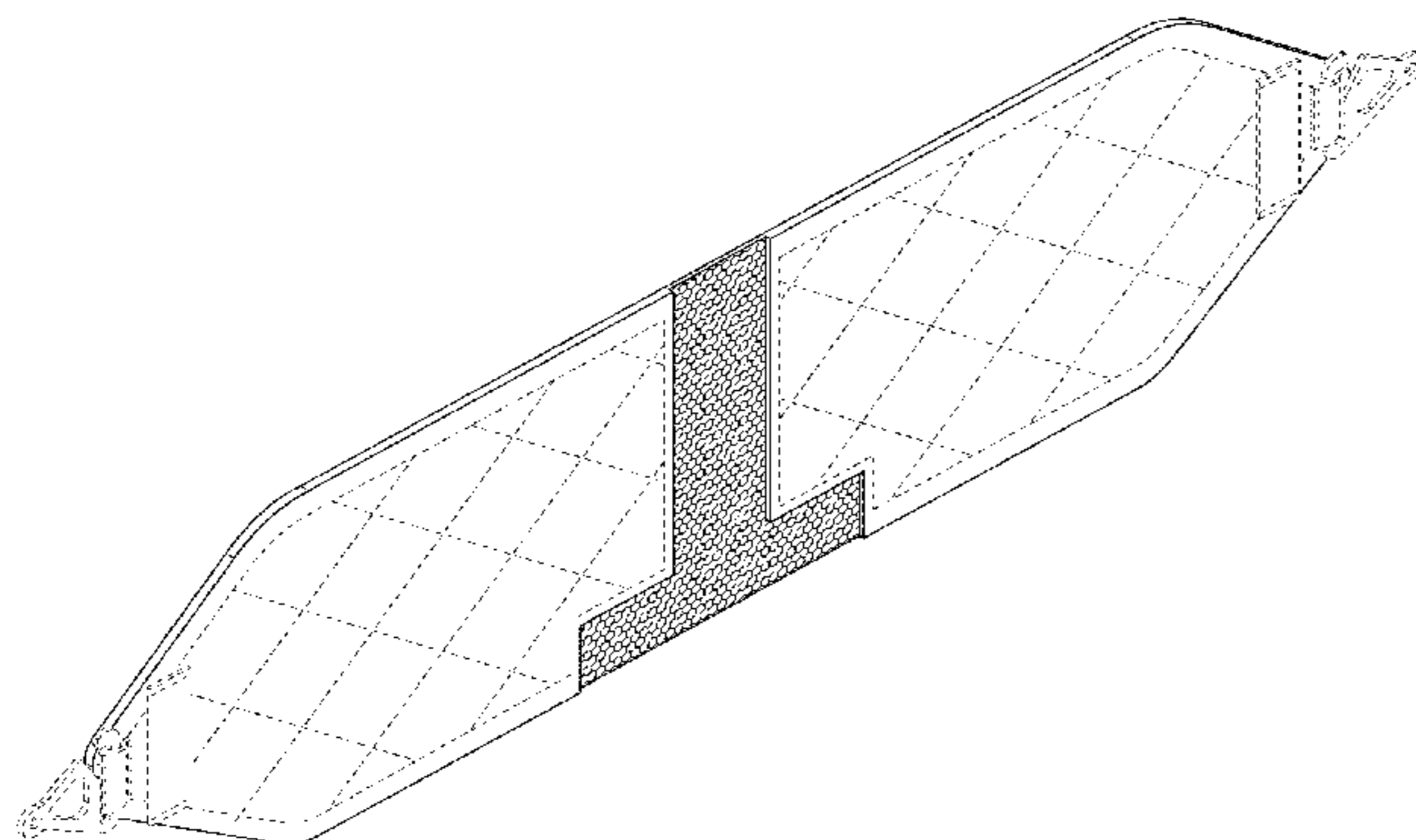

FIG. 24 is a further rear view thereof, wherein the wig grip band is shown deployed on the head of a wearer;  
 FIG. 25 is a further left side view thereof, wherein the wig grip band is shown deployed on the head of a wearer;  
 FIG. 26 is a further right side view thereof, wherein the wig grip band is shown deployed on the head of a wearer;  
 FIG. 27 is a further top view thereof, wherein the wig grip band is shown deployed on the head of a wearer; and,  
 FIG. 28 is a further bottom view thereof, wherein the wig grip band is shown deployed on the head of a wearer.  
 The broken lines in FIGS. 1-28 are for the purpose of illustrating portions of the wig grip band and environmental structure that form no part of the claimed design.

**1 Claim, 14 Drawing Sheets**

(58) **Field of Classification Search**

CPC ... A41G 3/00; A41G 5/00; A41G 5/04; A41G 5/0046; A41G 5/0053; A41G 5/006; A41G 5/0066; A41G 5/0073

See application file for complete search history.

(56) **References Cited**

U.S. PATENT DOCUMENTS

5,592,957	A	1/1997	Gazerro et al.	
D413,710	S	9/1999	De Rugeriis	
D494,711	S	8/2004	LeBow	
8,186,361	B2	5/2012	Hampton	
D669,633	S	10/2012	Hedgren	
D712,094	S	8/2014	Branson	
D742,072	S	10/2015	Dixon-Miller	
9,179,721	B2	11/2015	Hines et al.	
D746,516	S	12/2015	Cardello et al.	
D752,815	S	3/2016	Cardello et al.	
9,930,919	B1 *	4/2018	Branker	A45D 8/24
D873,493	S	1/2020	Geisinsky et al.	
D879,382	S	3/2020	Ning	
D893,104	S	8/2020	Ning	
D895,900	S	9/2020	Ning	
D939,146	S *	12/2021	Geisinsky	D28/93
D939,777	S *	12/2021	Geisinsky	D28/93
2014/0116456	A1	5/2014	Palmer-Rogers	
2018/0206571	A1 *	7/2018	Kim	A41G 3/0016
2020/0268084	A1 *	8/2020	Sim	A41G 5/0093
2022/0142279	A1 *	5/2022	Young	A41G 5/0073

FOREIGN PATENT DOCUMENTS

CN	305501285	S	12/2019
CN	305506412	S	12/2019
CN	306114724	S	10/2020

GB	4035095	4/2014
GB	6019169	9/2017
GB	6019170	9/2017
GB	6019171	9/2017
GB	6019173	9/2017
JP	D1088632	8/2000
JP	D1337804	7/2008
JP	D1337806	7/2008
JP	D1337807	7/2008
JP	D1338290	7/2008
JP	D1379926	1/2010
JP	D1391781	6/2010
JP	D1586936	9/2017
KR	3002983000000	5/2002
KR	3006686140001	11/2012
KR	3009413800000	1/2018
KR	3009413830000	1/2018
KR	3009413840000	1/2018
KR	3009417980000	1/2018
WO	DM/094688	11/2016

OTHER PUBLICATIONS

Title: Milano collection lace WiGrip velvet comfort wig grip band for lace wigs and frontals with reinforced swiss lace by hairline and part; URL: <https://www.mcwigs.com/lacegrip.html> ; Accessed date: Feb. 5, 2021.

Title: Transparent lace wig grip headband adjustable wig cap wig making wig holding supplies, hat 5pcs free shipping; URL:[https://pl.aliexpress.com/item/4000108829529.html?spm=a2g17.search0303.349.1ae43090jeJwhL&ws\\_ab\\_test=searchweb0\\_0,searchweb201602\\_0,searchweb201603\\_0,ppcSwitch\\_0&algo\\_pvid=d3f08af5-5fca-47bd-b2cb-45641921c2ce&algo\\_expid=d3f08af5-5fca-47bd-b2cb-4564f921c2ce-6](https://pl.aliexpress.com/item/4000108829529.html?spm=a2g17.search0303.349.1ae43090jeJwhL&ws_ab_test=searchweb0_0,searchweb201602_0,searchweb201603_0,ppcSwitch_0&algo_pvid=d3f08af5-5fca-47bd-b2cb-45641921c2ce&algo_expid=d3f08af5-5fca-47bd-b2cb-4564f921c2ce-6) ; Accessed date: Feb. 5, 2021.

Title: U Part Wig Caps With Lace Net For Making Wigs With Adjustable Straps; URL: <https://in.pinterest.com/pin/630644754049080146/> ; Accessed date: Feb. 5, 2021.

Title: New arrival velvet wig grip wig band with adjustable strap beige colour; URL: <https://www.ebay.com/itm/New-arrival-Velvet-Wig-Grip-Wig-Band-with-adjustable-strap-beige-colour-/123953494368> ; Accessed date: Feb. 5, 2021.

Title: GEX wig grip band adjustable wig comfort band headband flexible velvet scarf wig comfort non-slip adjustable fasten new design wig bands with arch extra hold for women (Brown); URL: <https://www.ubuy.co.in/search/index/view/product/B07VMCPYBY/s/gex-wig-grip-band-adjustable-wig-comfort-band-headband-flexible-velvet-scarf-wig-comfort-non-slip-adjustable-fasten-new-design-wig-bands-with-arch-extra-hold-for-women-brown/store/store/kk/dp> ; Accessed date: Feb. 5, 2021.

\* cited by examiner

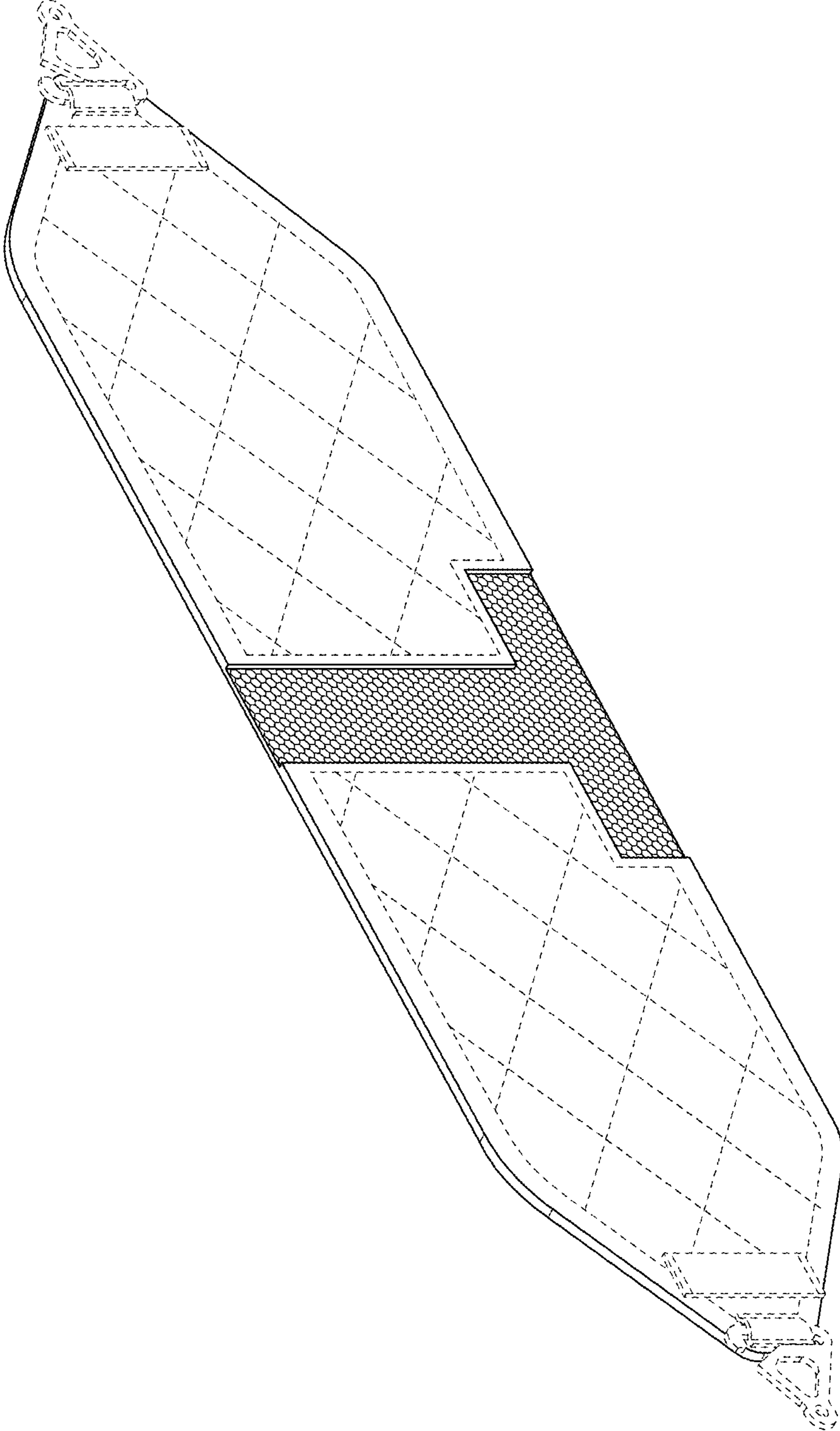
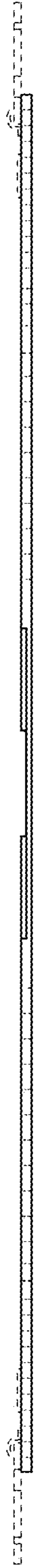

FIG. 1



**FIG. 2**



**FIG. 3**

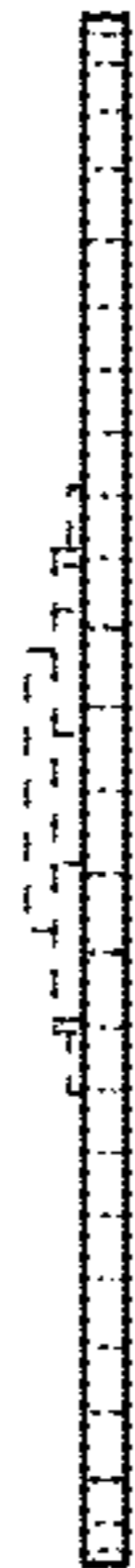

**FIG. 4**

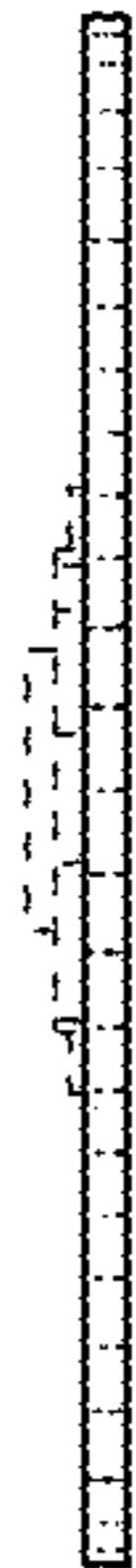

**FIG. 5**

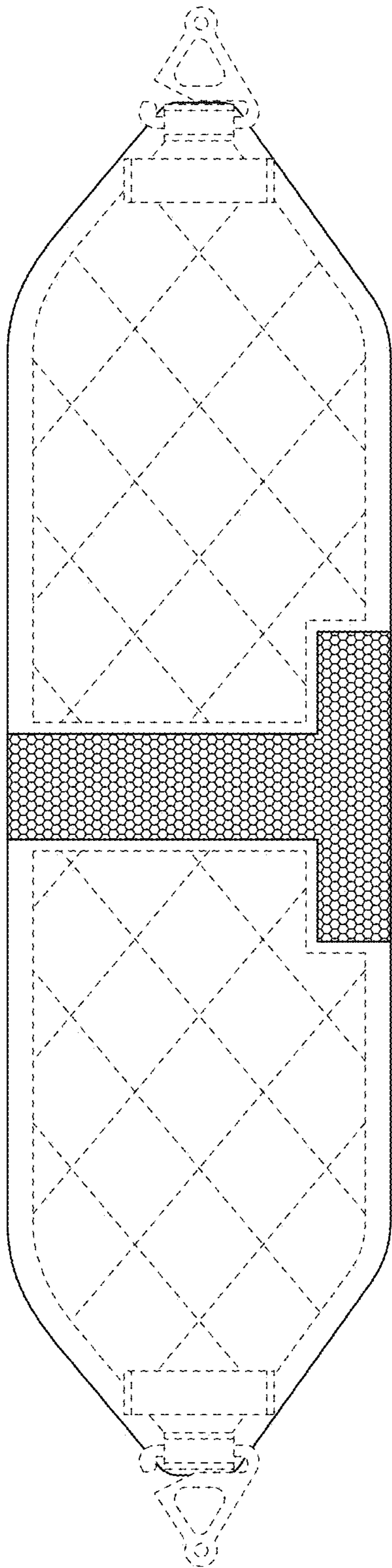

FIG. 6

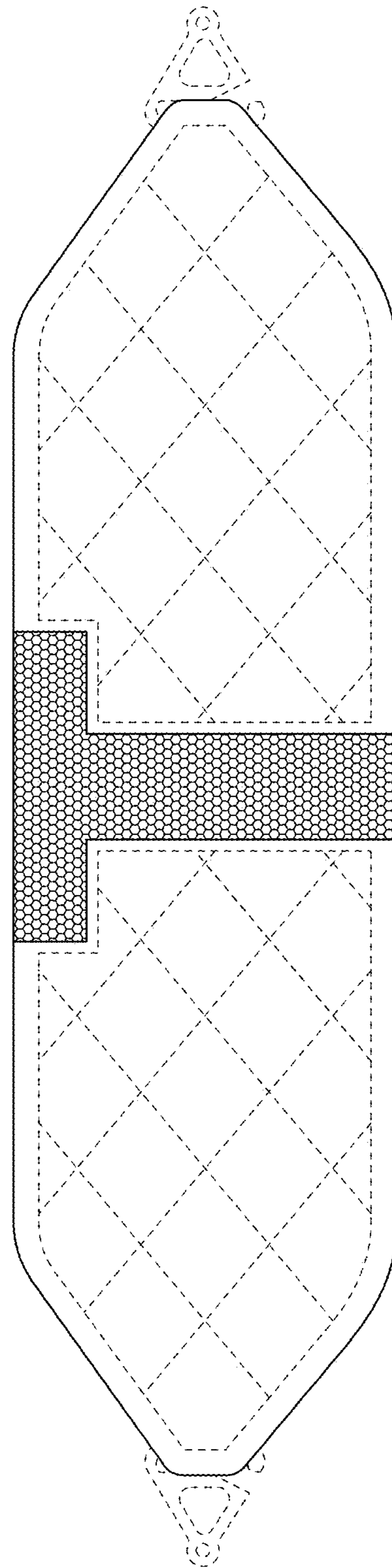

FIG. 7

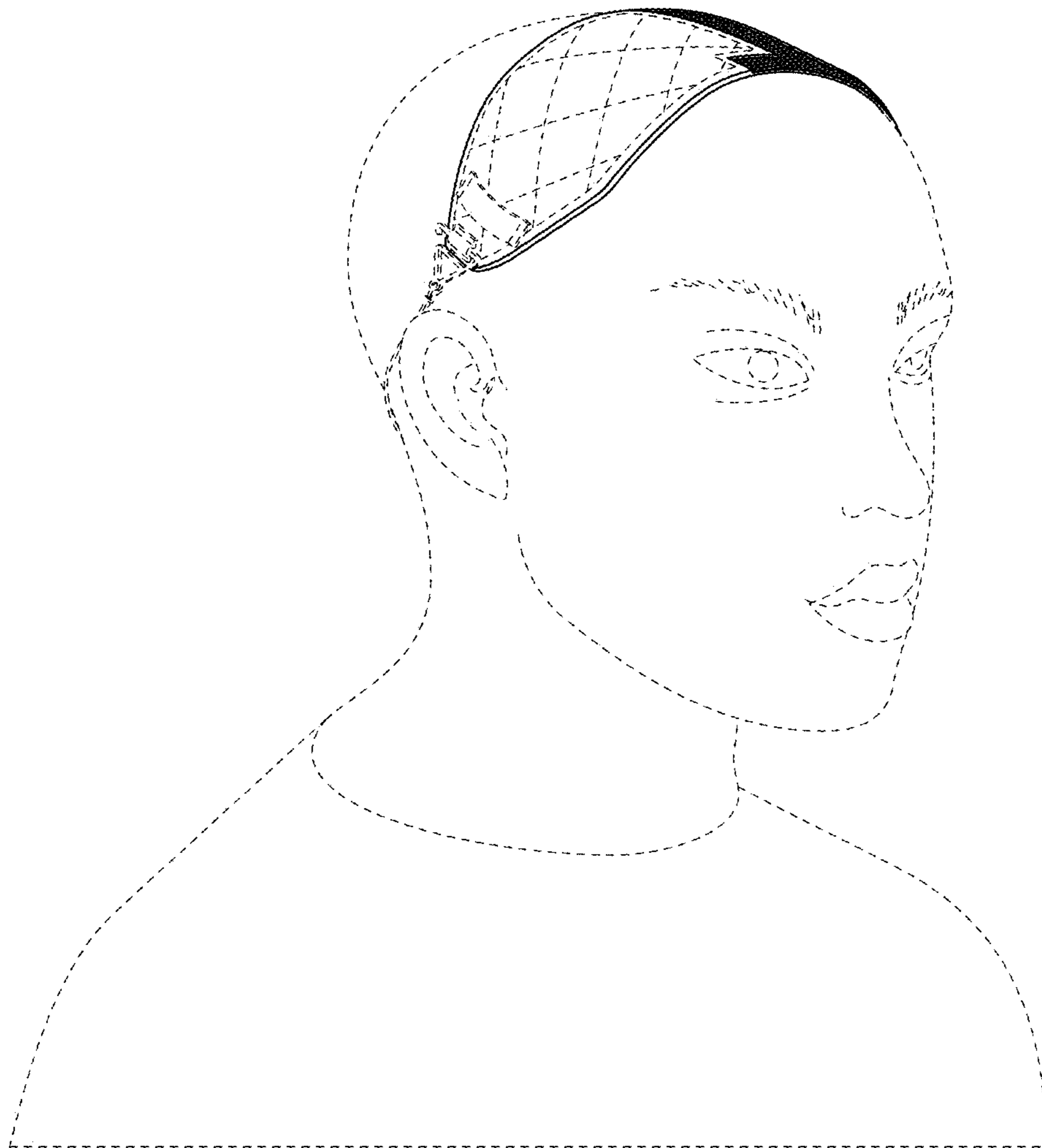

FIG. 8

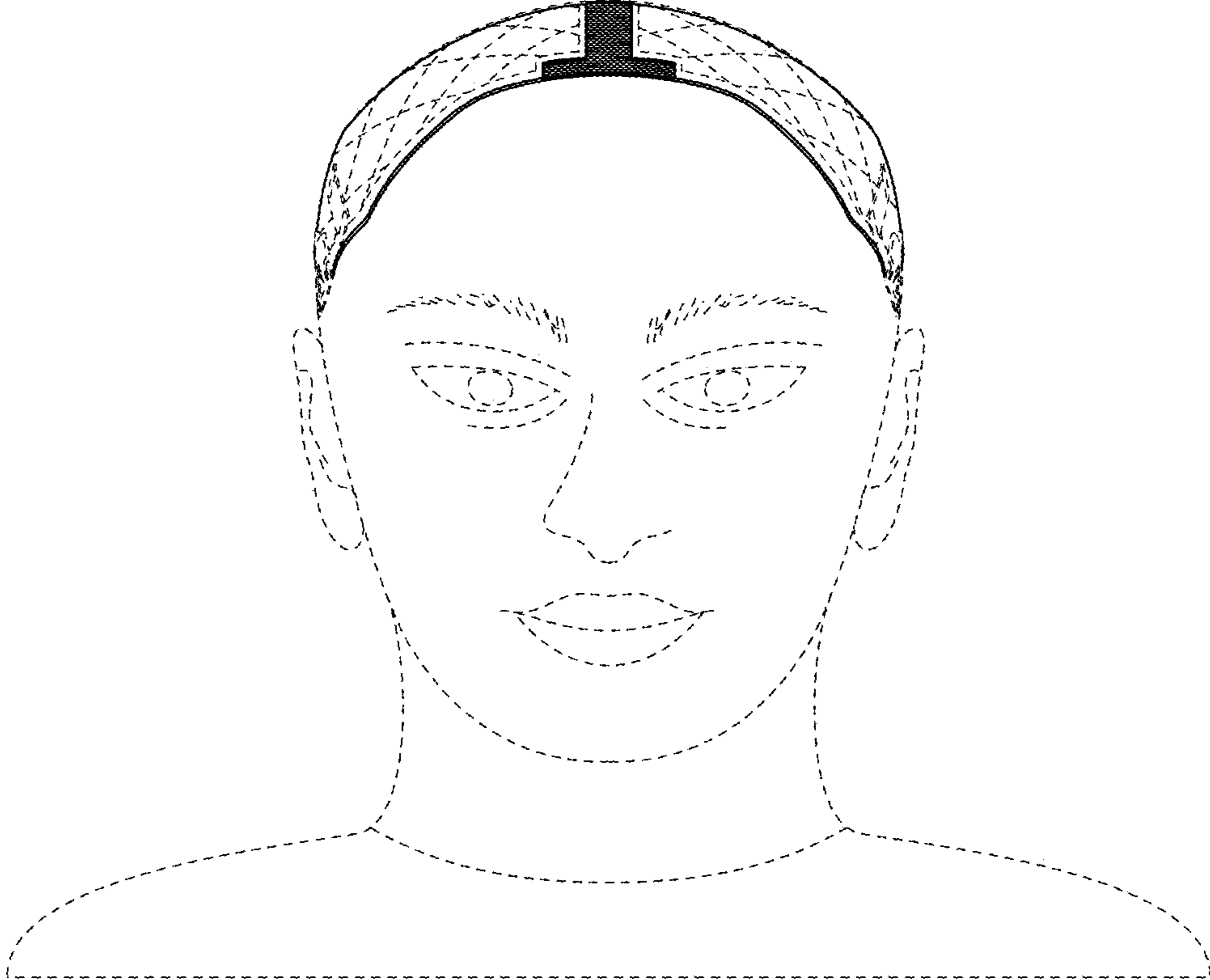

FIG. 9

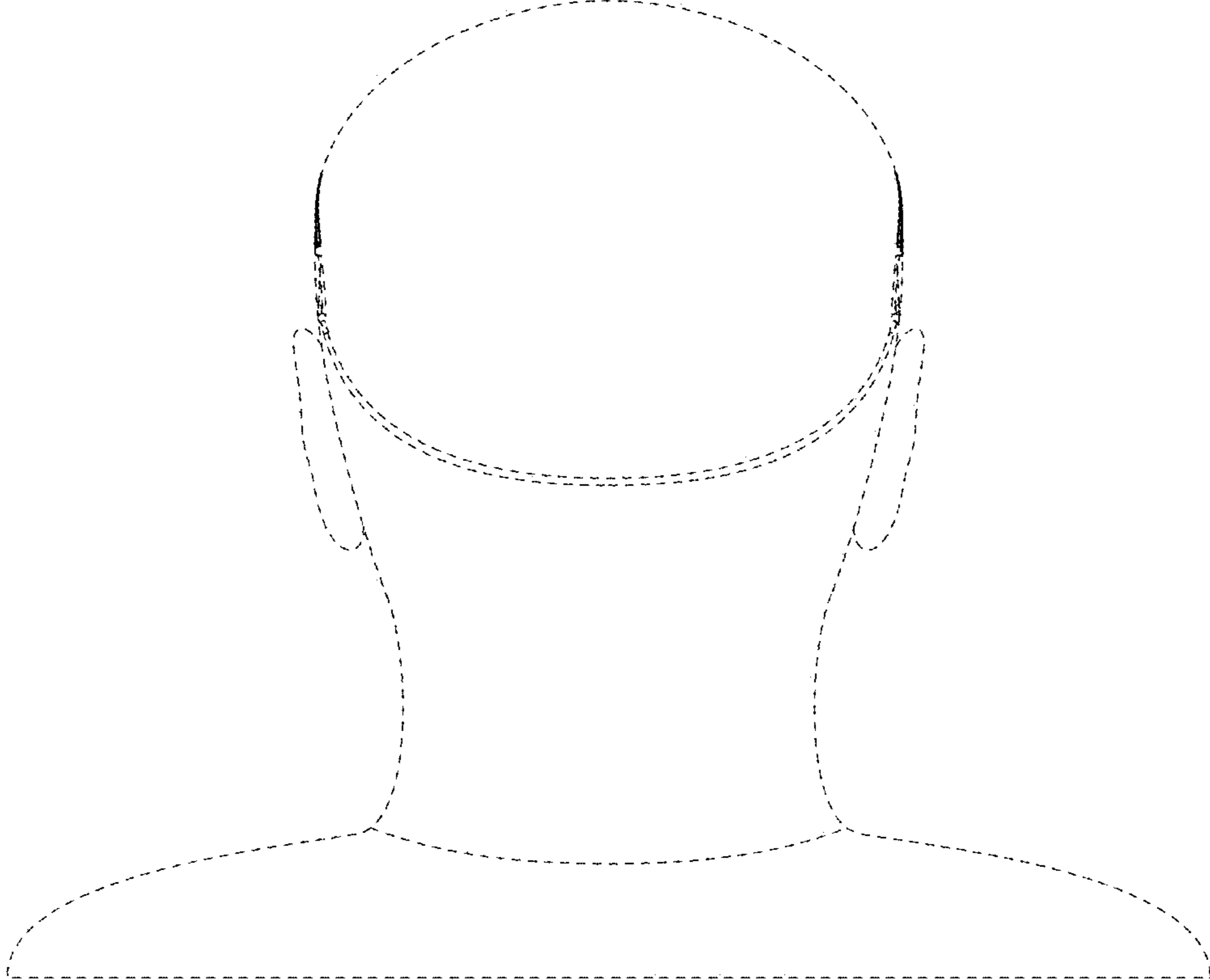
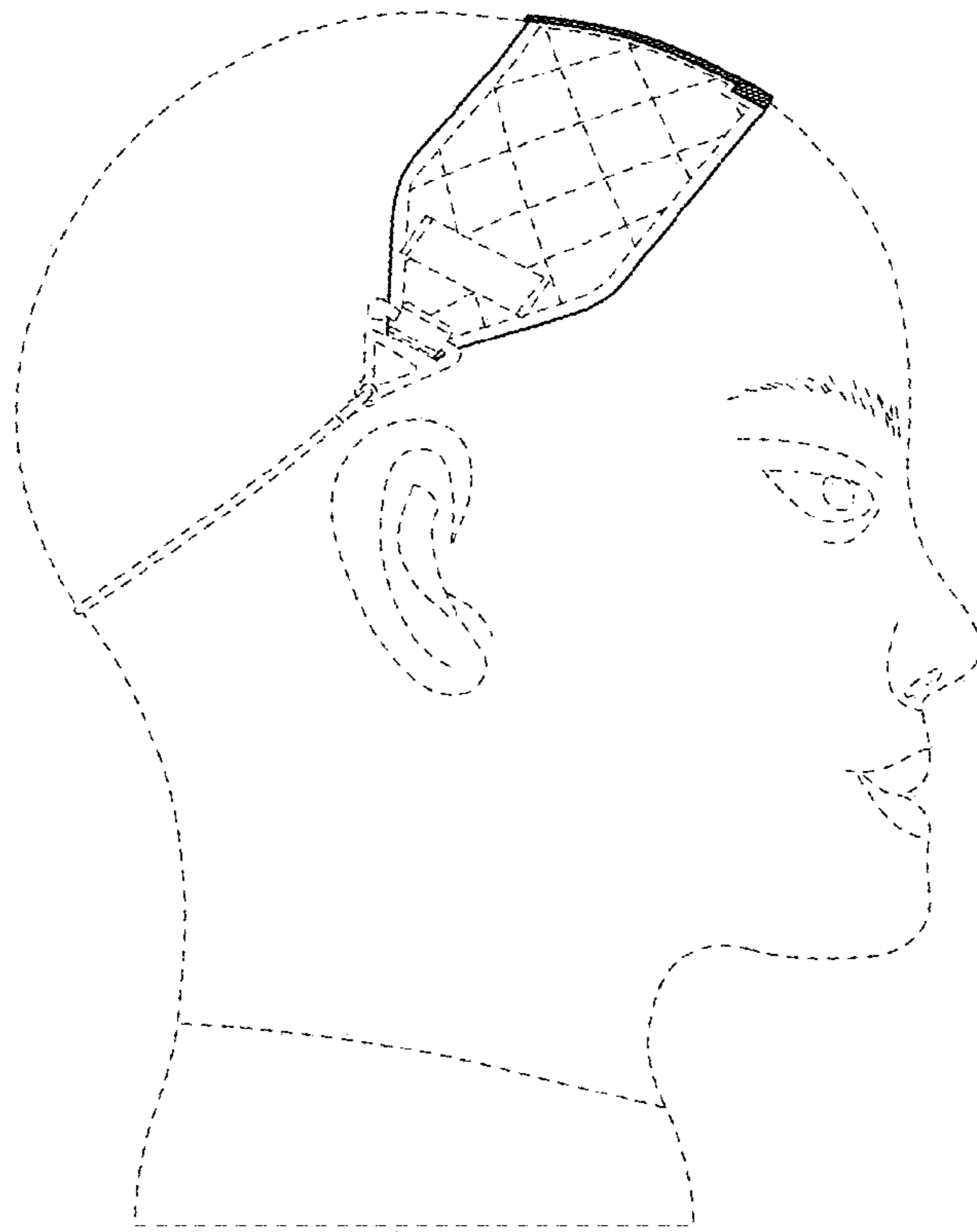
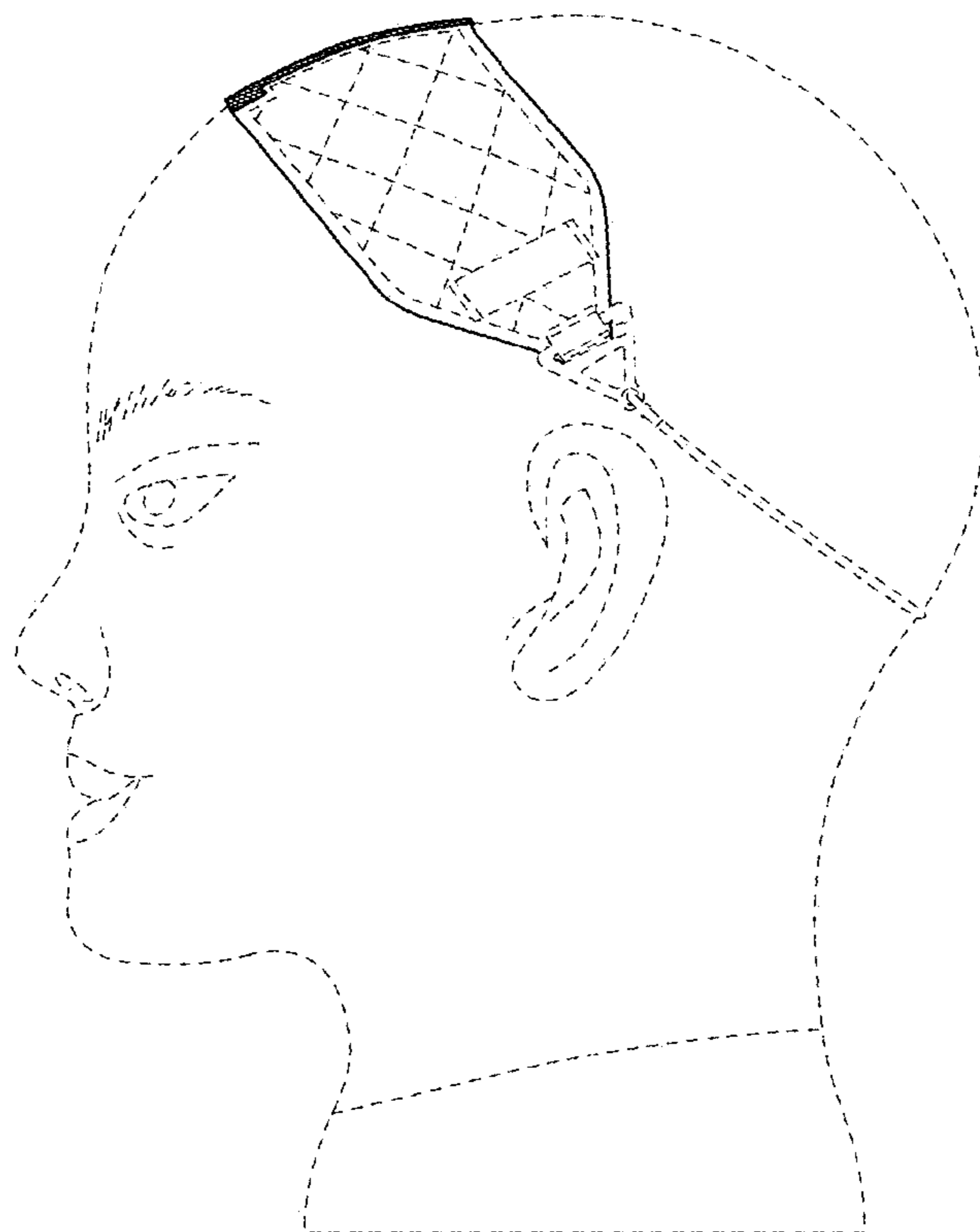

FIG. 10



**FIG. 11**



**FIG. 12**



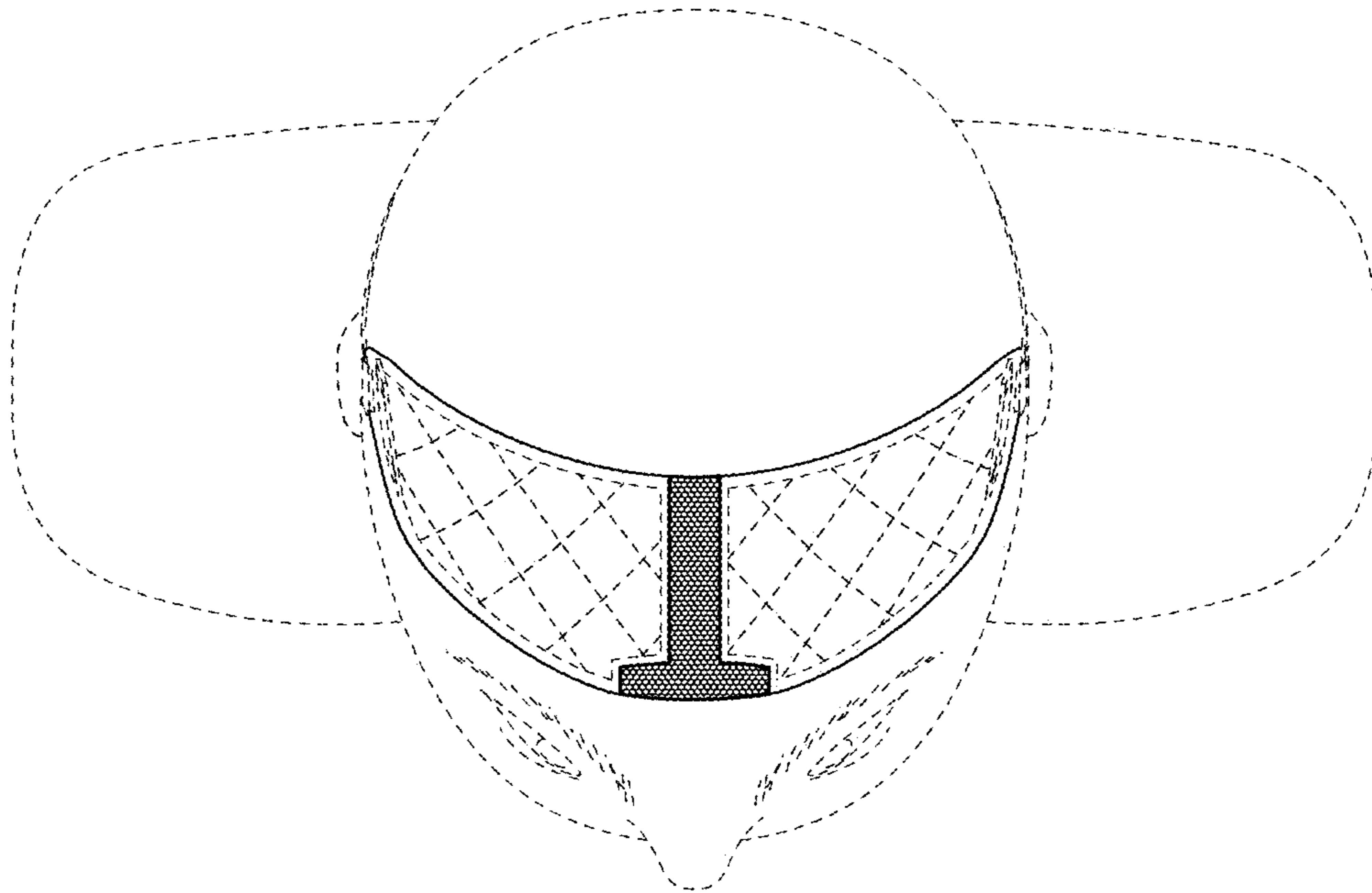

FIG. 13

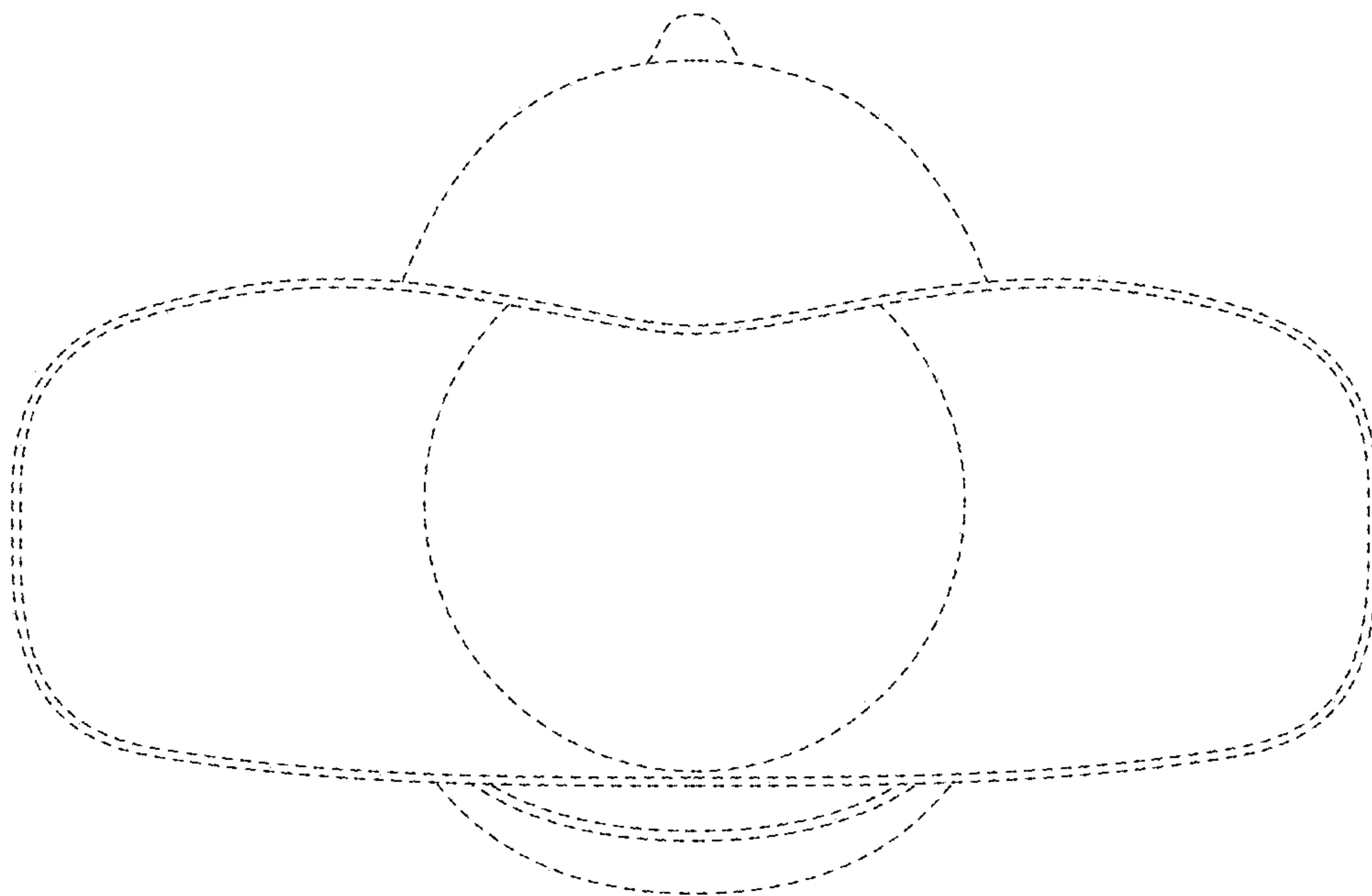

FIG. 14

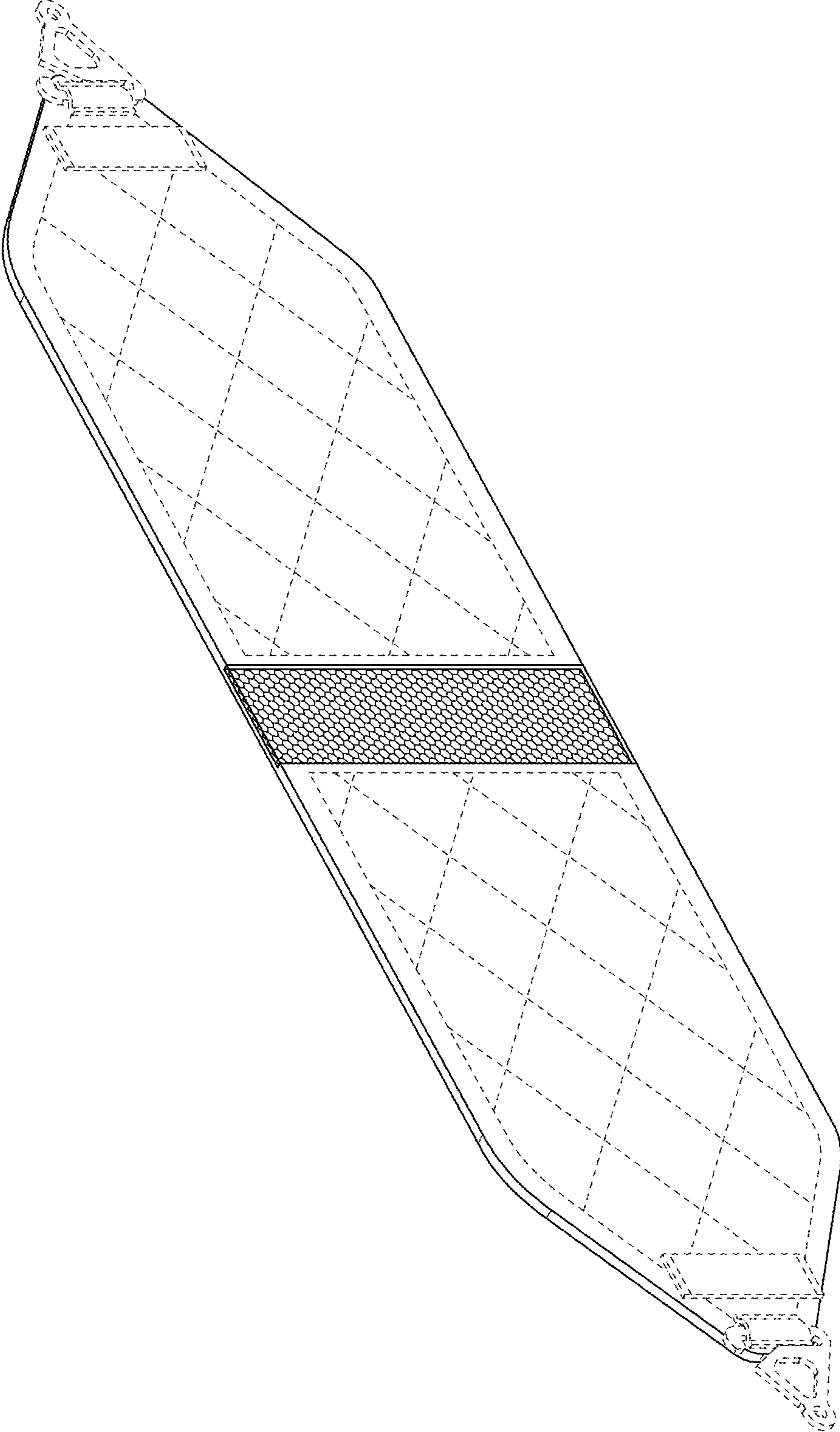
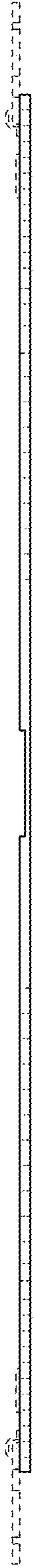

FIG. 15



**FIG. 16**



**FIG. 17**

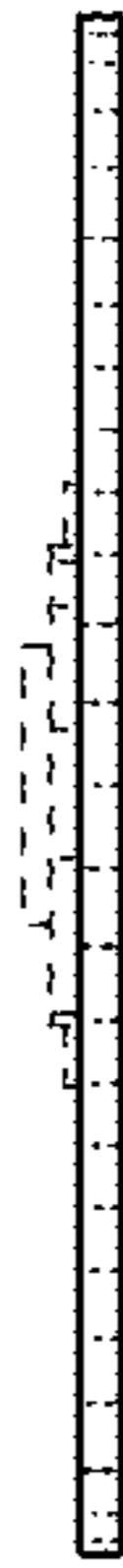

**FIG. 18**

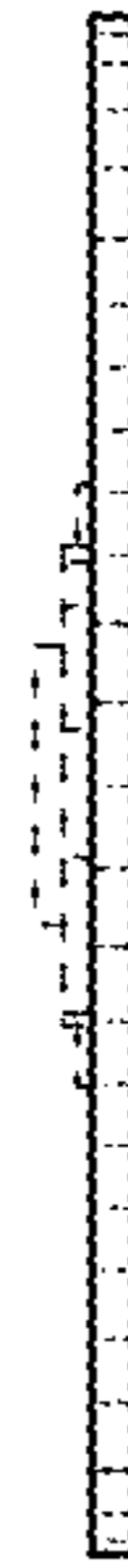

**FIG. 19**

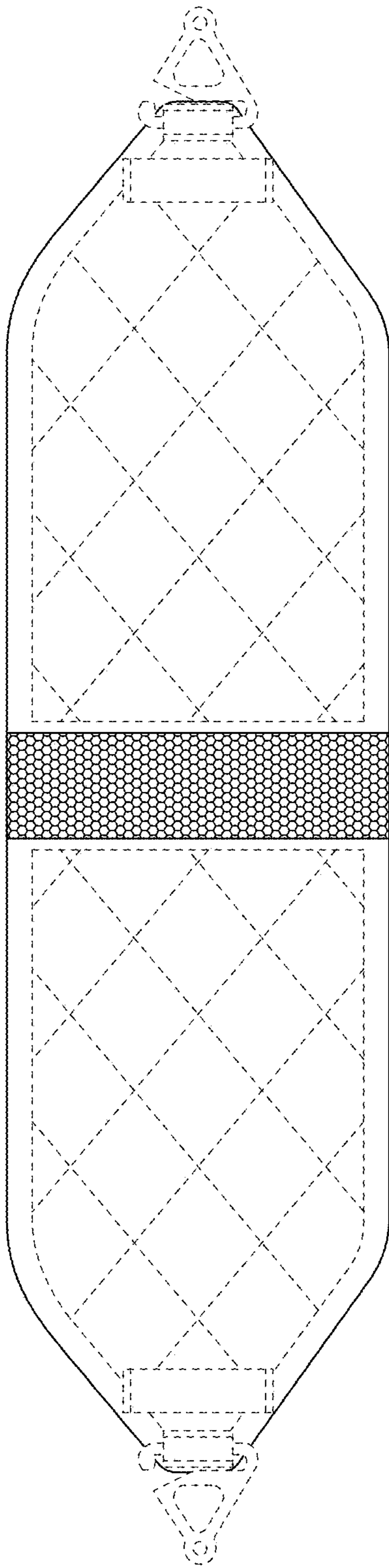

FIG. 20

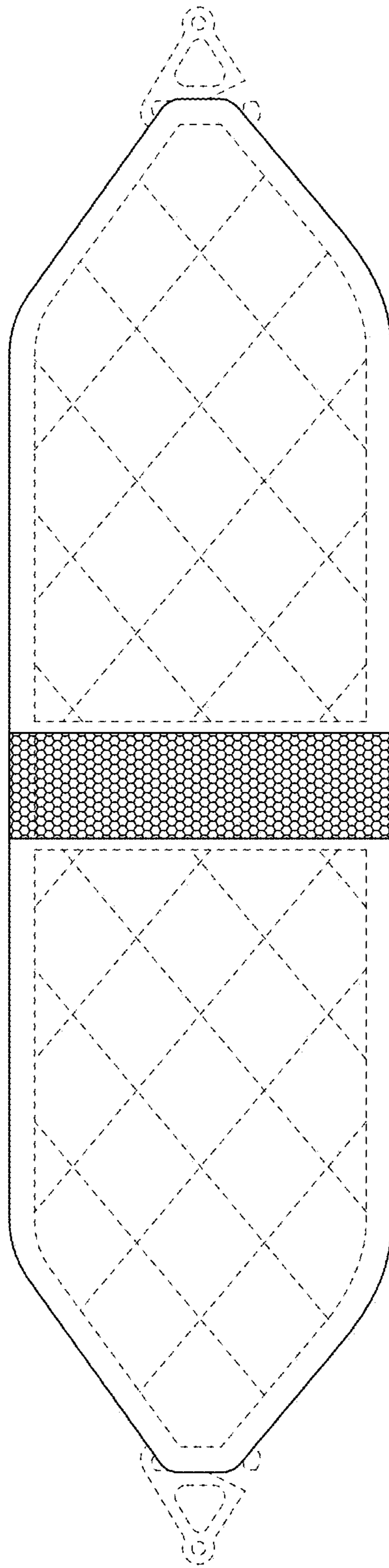

FIG. 21

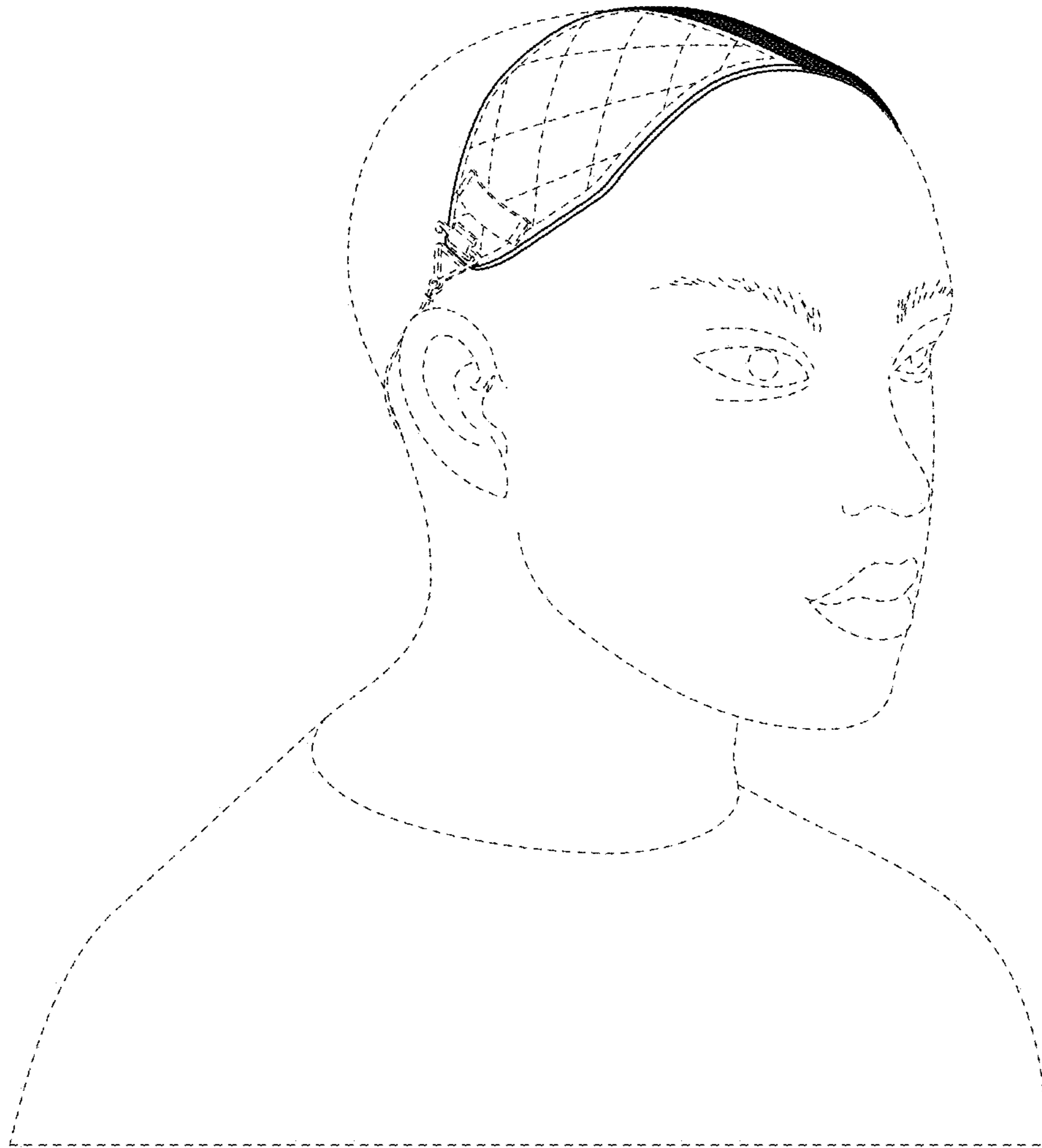
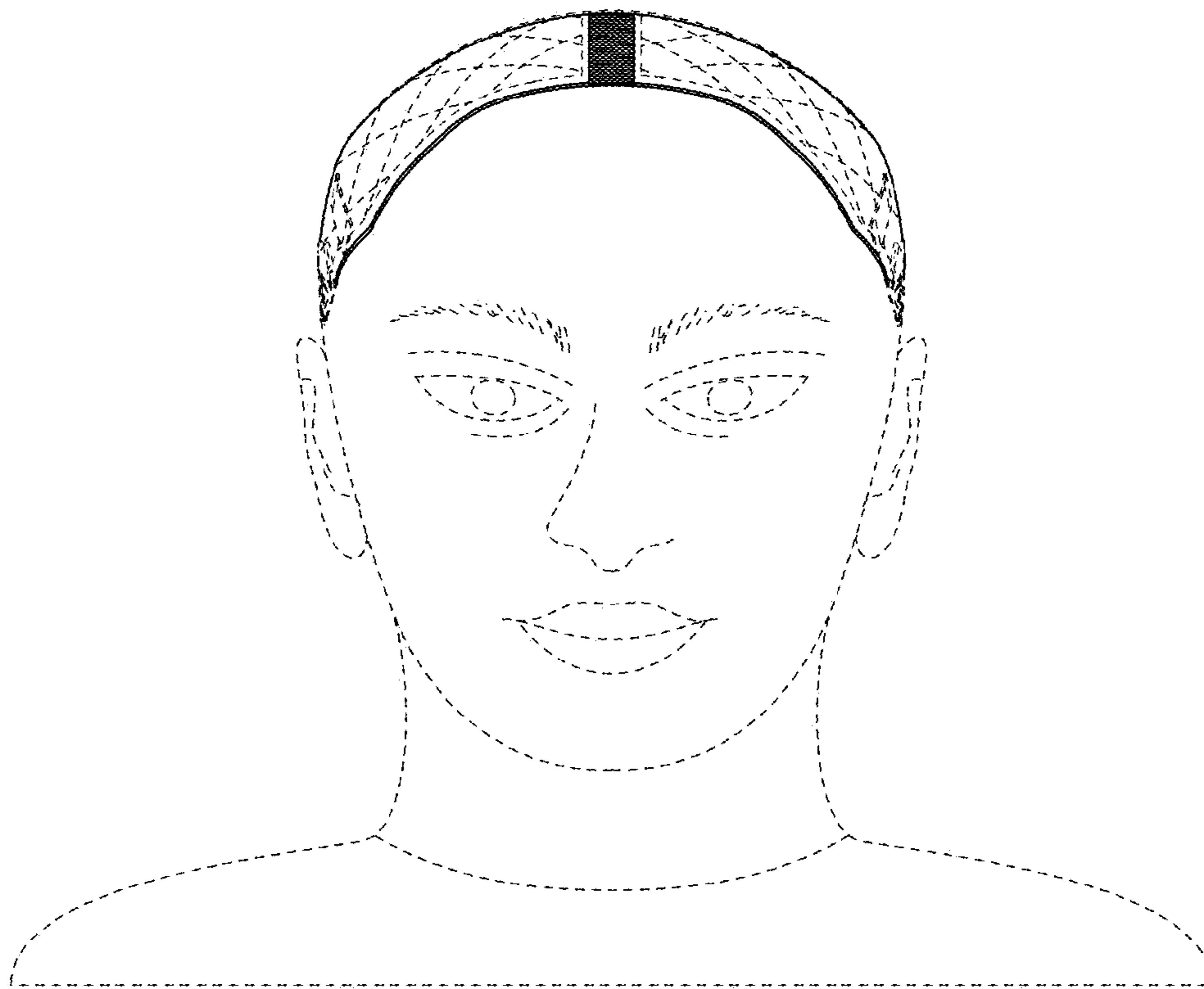
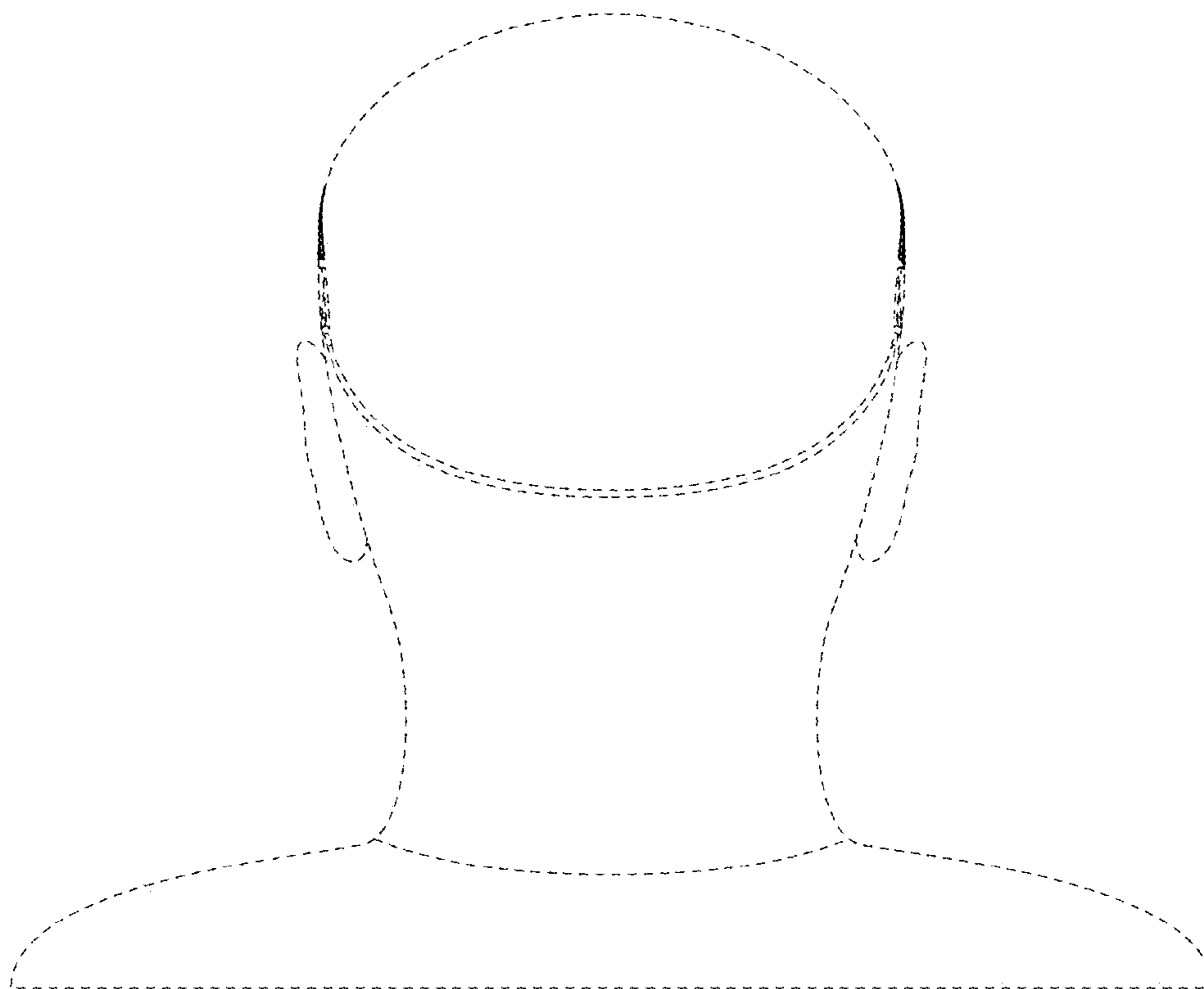

FIG. 22



**FIG. 23**



**FIG. 24**

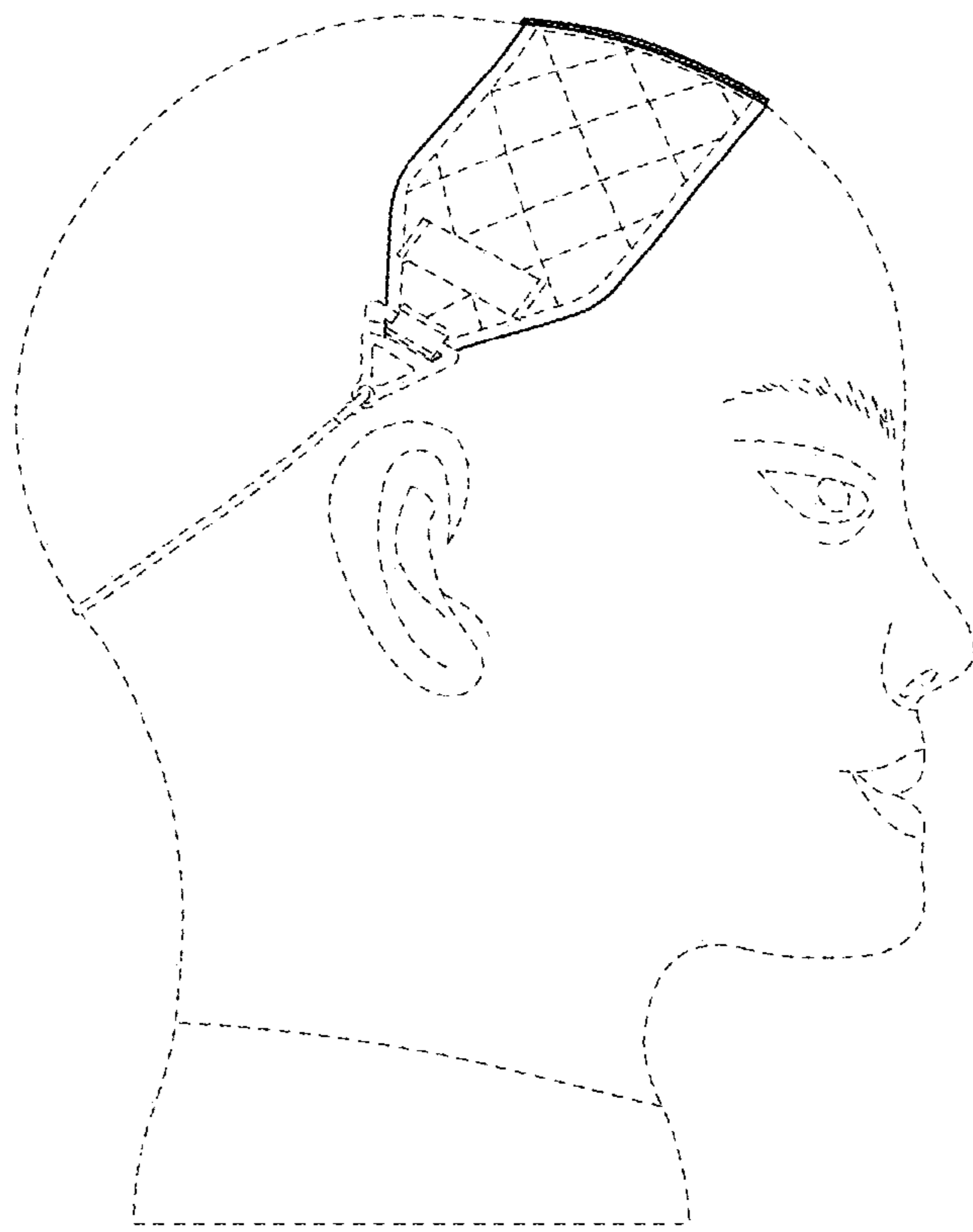

**FIG. 25**

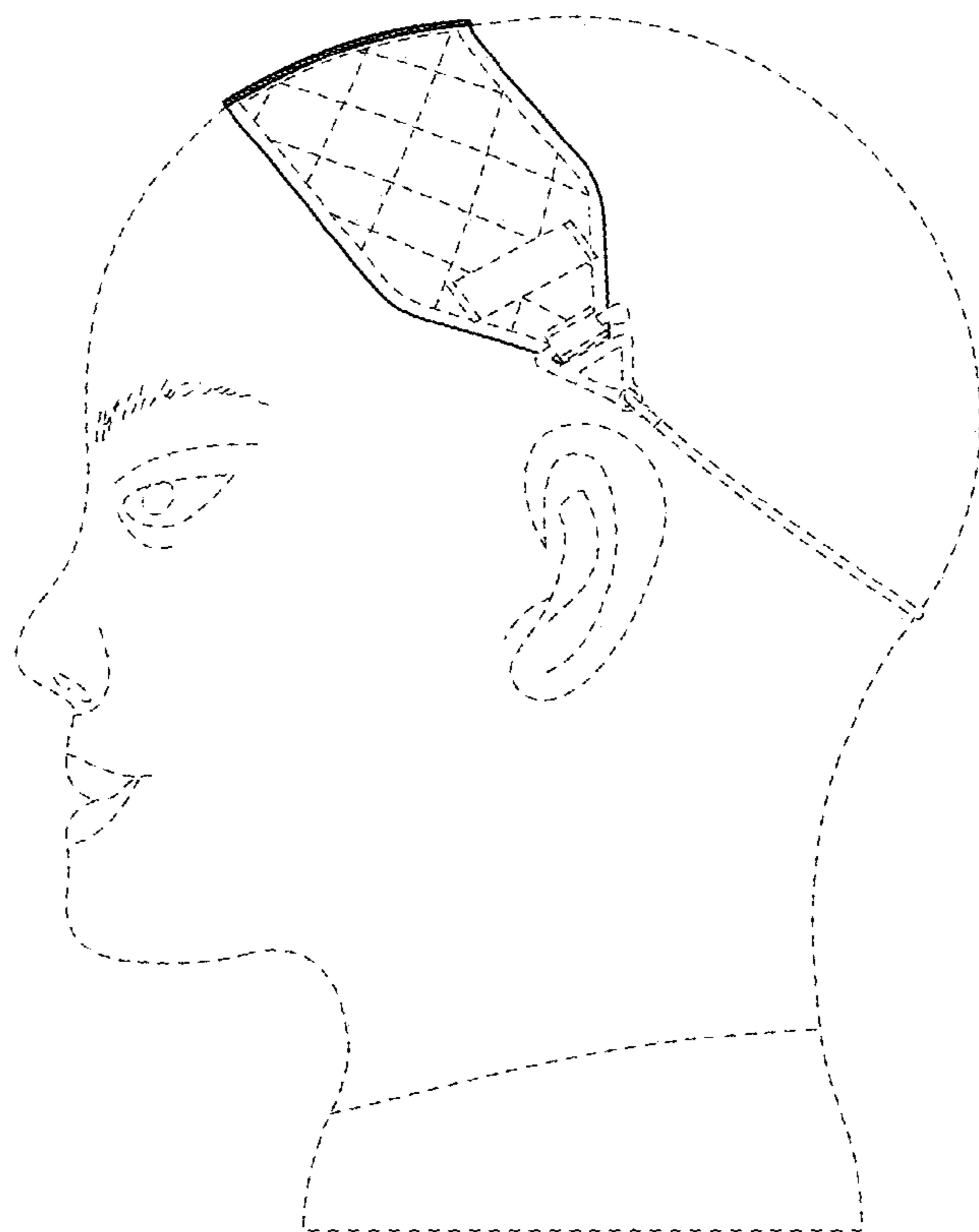

**FIG. 26**

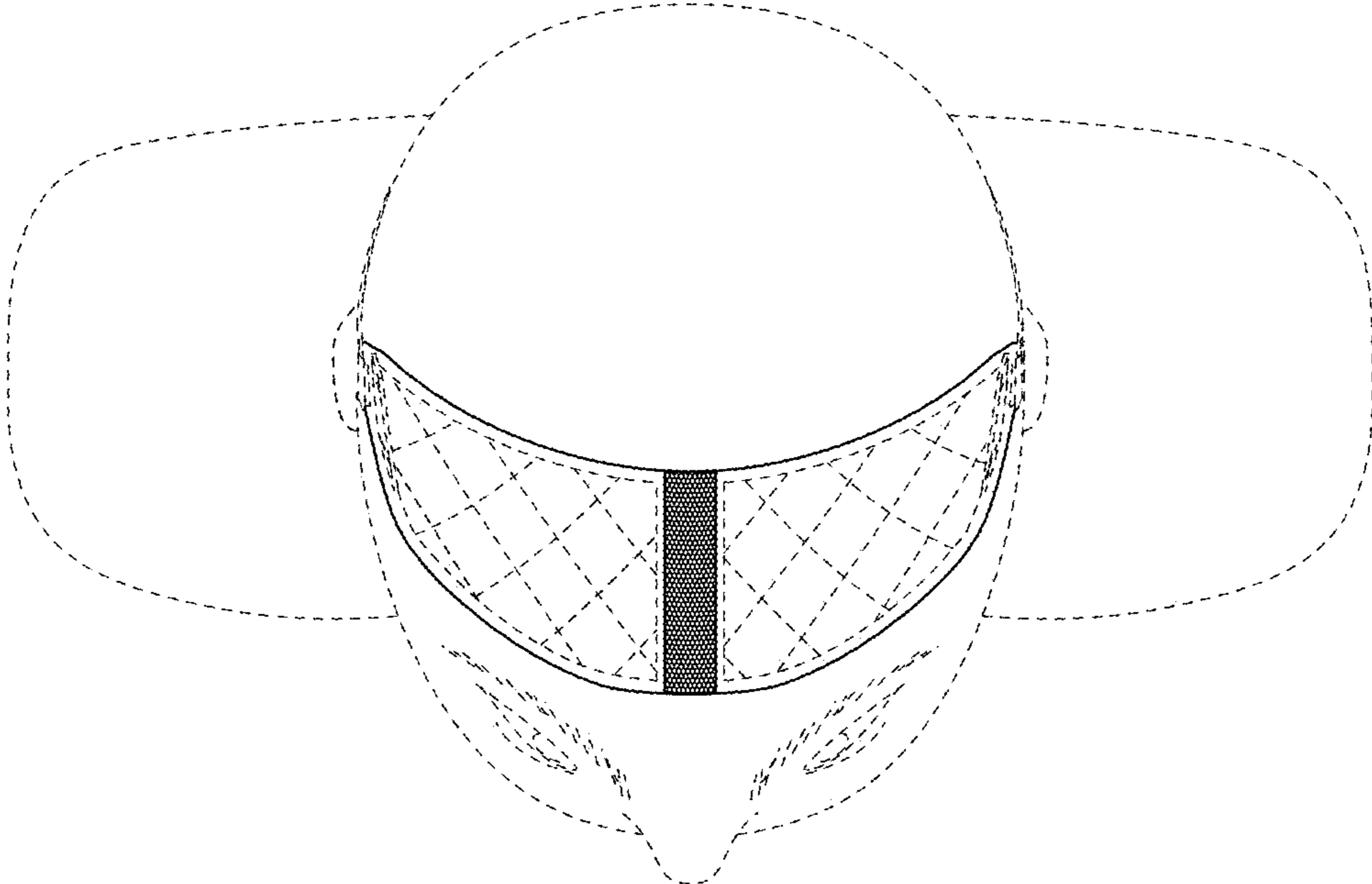

FIG. 27

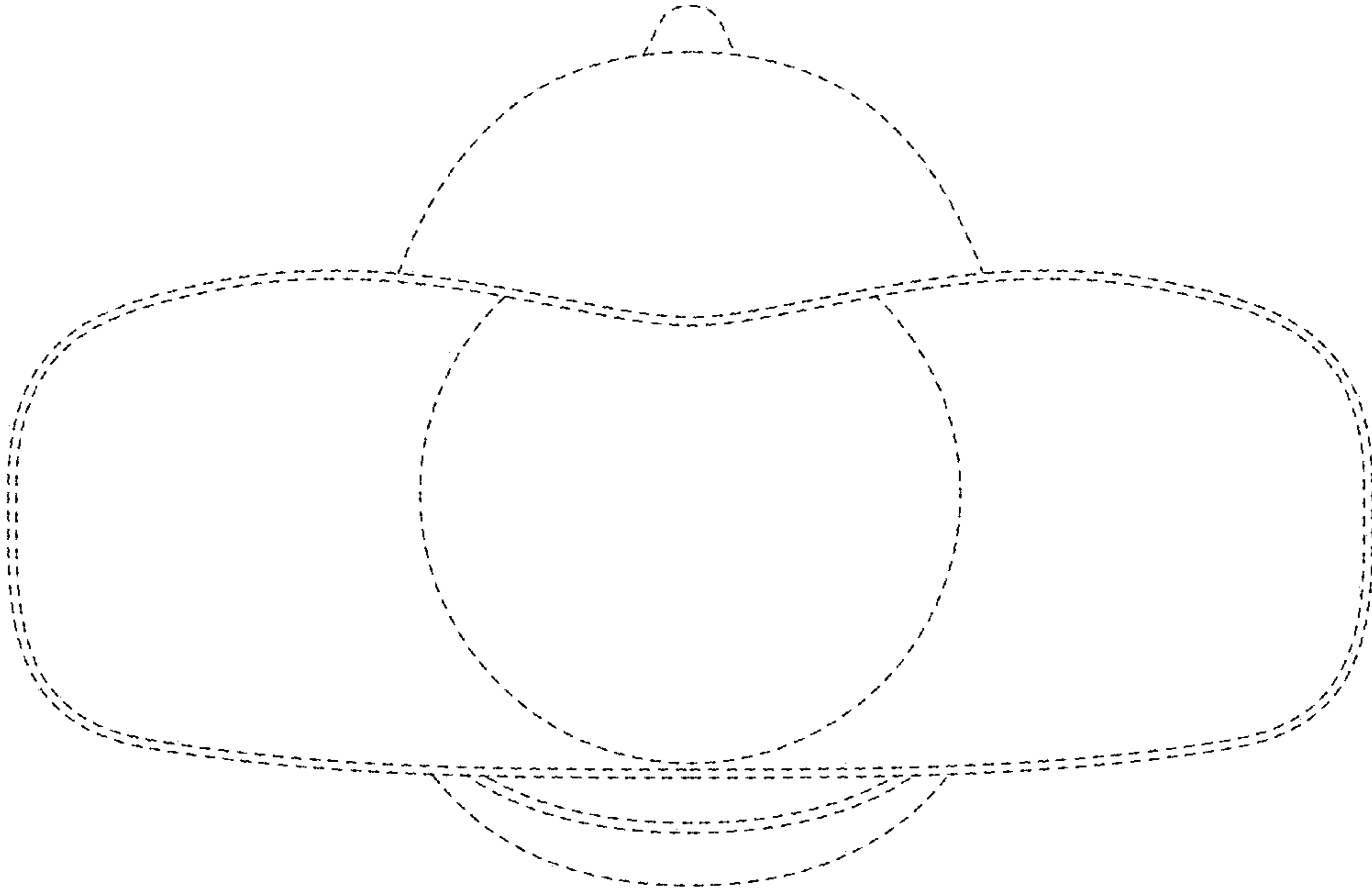

FIG. 28