

US00D973946S

(12) **United States Design Patent** (10) **Patent No.:** **US D973,946 S**  
**Feng** (45) **Date of Patent:** **\*\* Dec. 27, 2022**

(54) **LAMP**  
(71) Applicant: **Zhanbi Feng**, Zhongshan (CN)  
(72) Inventor: **Zhanbi Feng**, Zhongshan (CN)  
(\*\*) Term: **15 Years**  
(21) Appl. No.: **29/789,463**  
(22) Filed: **Sep. 25, 2021**  
(51) **LOC (13) Cl.** ..... **26-05**  
(52) **U.S. Cl.**  
USPC ..... **D26/87**  
(58) **Field of Classification Search**  
USPC ..... D26/72, 74, 76, 78-83, 85, 86, 87, 88,  
D26/90, 93, 111, 113, 118-122, 138, 139,  
D26/140, 141, 142, 152  
CPC ..... F21S 2/00; F21S 4/00; F21S 4/003; F21S  
4/005; F21S 4/006; F21S 4/007; F21S  
4/008; F21S 6/00; F21S 8/00; F21S  
8/024; F21S 8/026; F21S 8/031; F21S  
8/033; F21S 8/035-037; F21S 8/04; F21S  
8/043; F21S 8/063  
See application file for complete search history.

(56) **References Cited**

**U.S. PATENT DOCUMENTS**

D487,814 S \* 3/2004 Hoernig ..... D26/87  
D549,383 S \* 8/2007 Duggan ..... D26/85  
D621,083 S \* 8/2010 Coughaine ..... D26/61  
D626,264 S \* 10/2010 Liu ..... D26/61  
D819,868 S \* 6/2018 Qiao ..... D26/87  
D824,076 S \* 7/2018 Sonneman ..... D26/87  
D836,822 S 12/2018 Crocker  
D838,402 S \* 1/2019 Sonneman ..... D26/86

D866,814 S 11/2019 Tanaka et al.  
D866,843 S \* 11/2019 Benghozi ..... D26/87  
D890,394 S \* 7/2020 Cameron ..... D26/3  
D895,876 S 9/2020 Tang  
D906,584 S \* 12/2020 Moses ..... D26/138  
D907,276 S \* 1/2021 Jiang ..... D26/87  
D908,946 S \* 1/2021 Lainez ..... D26/87  
D923,222 S \* 6/2021 Le ..... D26/42  
D936,263 S \* 11/2021 Yang ..... D26/60  
D946,803 S \* 3/2022 Pang ..... D26/60  
D957,019 S \* 7/2022 Yang ..... D26/60  
D957,020 S \* 7/2022 Yang ..... D26/60  
D957,027 S \* 7/2022 Yang ..... D26/76

\* cited by examiner

*Primary Examiner* — Natasha Vujcic

(74) *Attorney, Agent, or Firm* — Rumit Ranjit Kanakia

(57) **CLAIM**

The ornamental design for a lamp, as shown and described.

**DESCRIPTION**

FIG. 1 is a first perspective view of a lamp showing my new design;  
FIG. 2 is a second perspective view thereof;  
FIG. 3 is a front view thereof;  
FIG. 4 is a back view thereof;  
FIG. 5 is a left side view thereof;  
FIG. 6 is a right side view thereof;  
FIG. 7 is a top view thereof;  
FIG. 8 is a bottom view thereof; and,  
FIG. 9 is an enlarged view of the selected portion in FIG. 1.  
The broken lines shown in the drawings depict portions of the lamp in which the design is embodied that form no part of the claimed design.

**1 Claim, 9 Drawing Sheets**

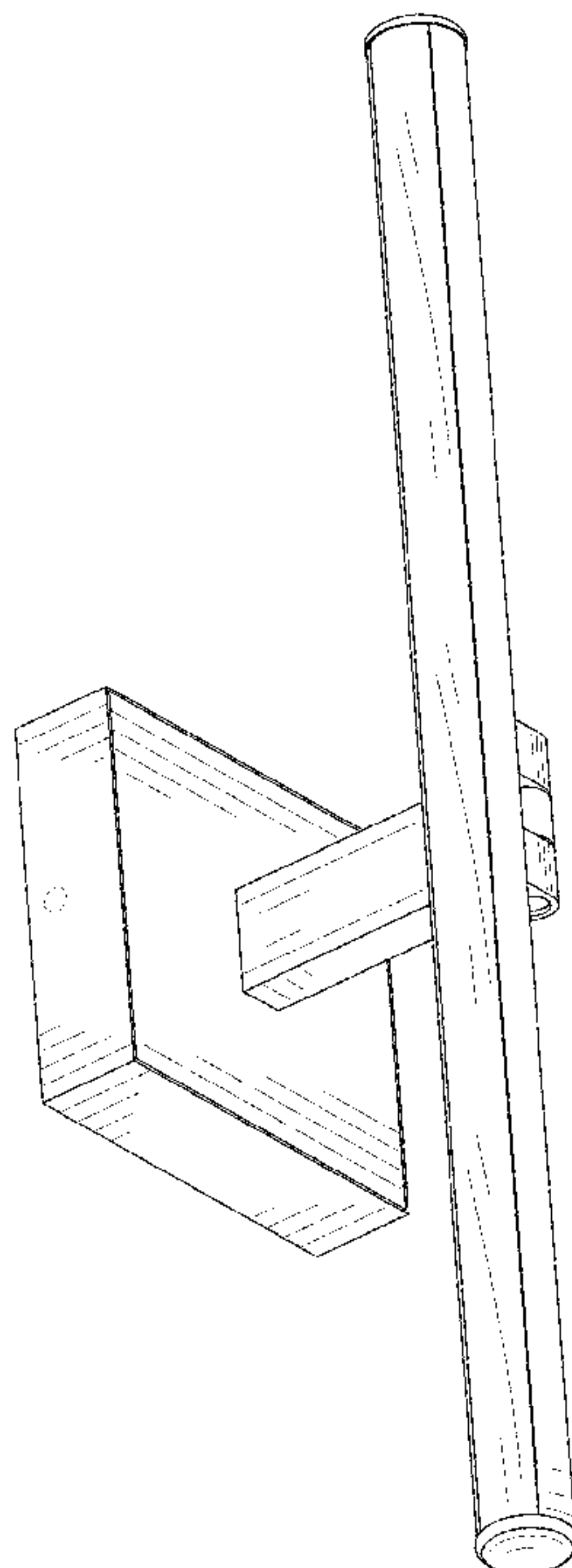

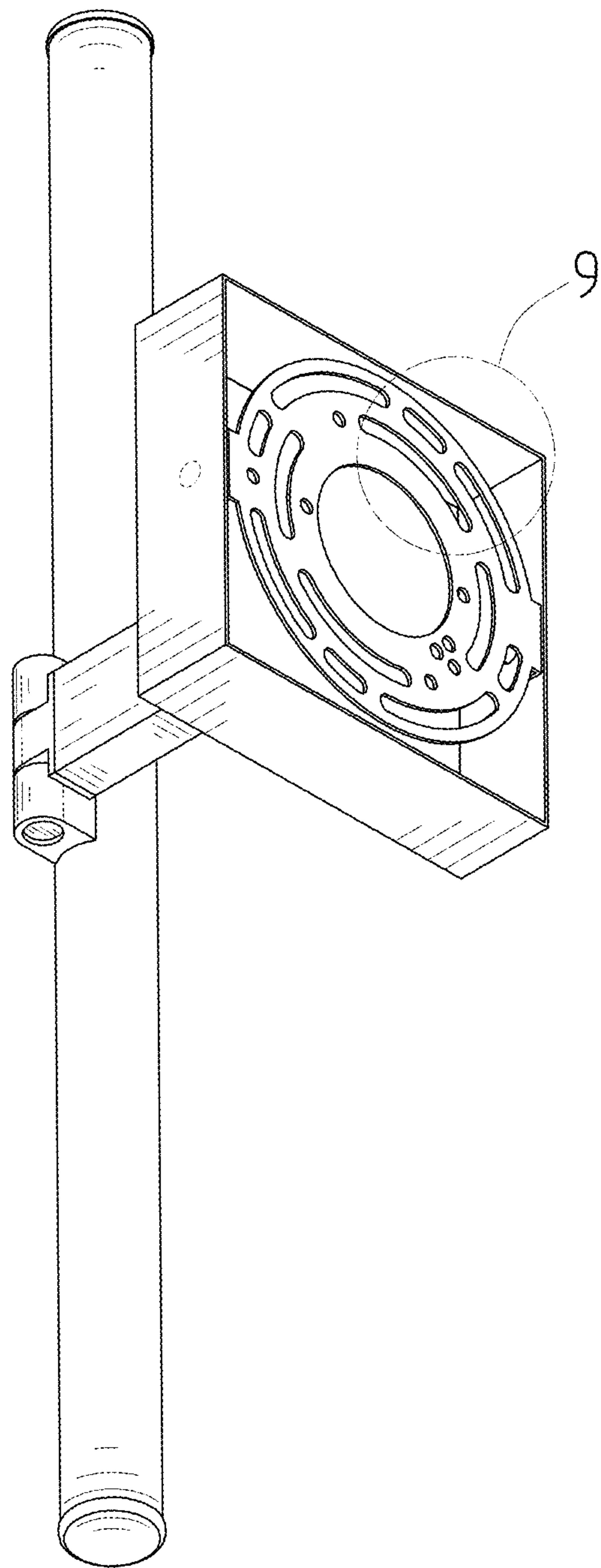

FIG. 1

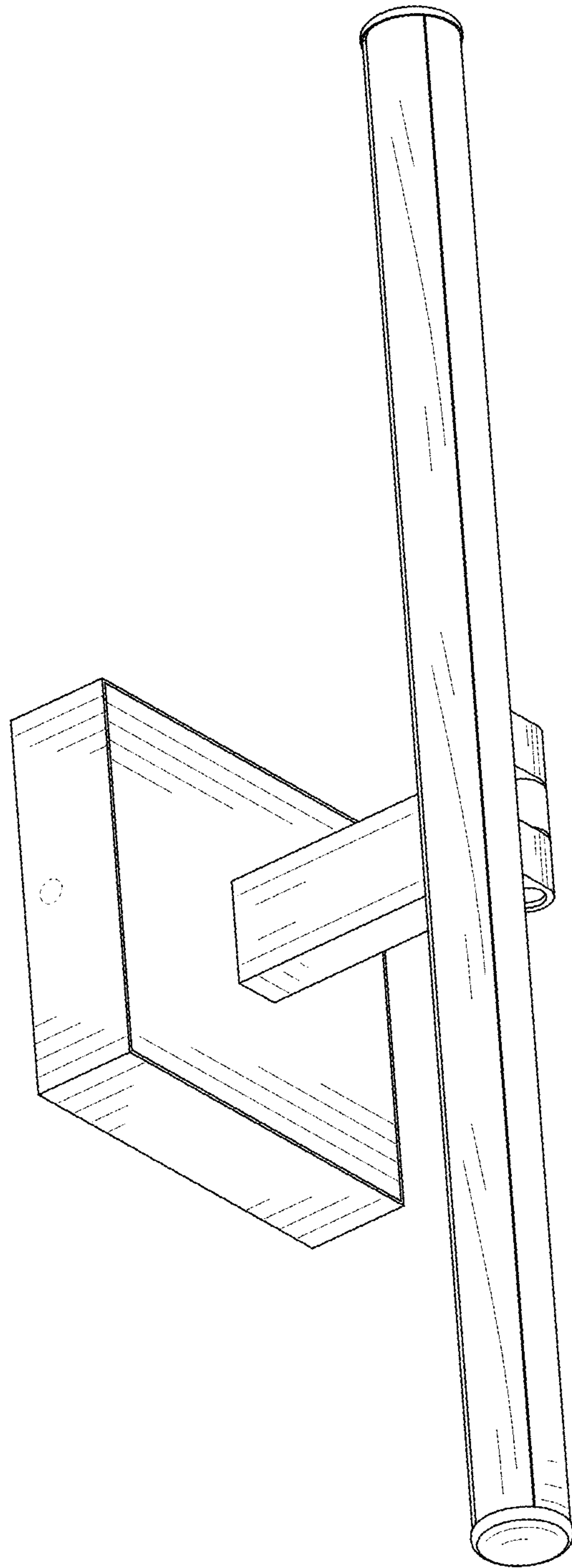

FIG. 2

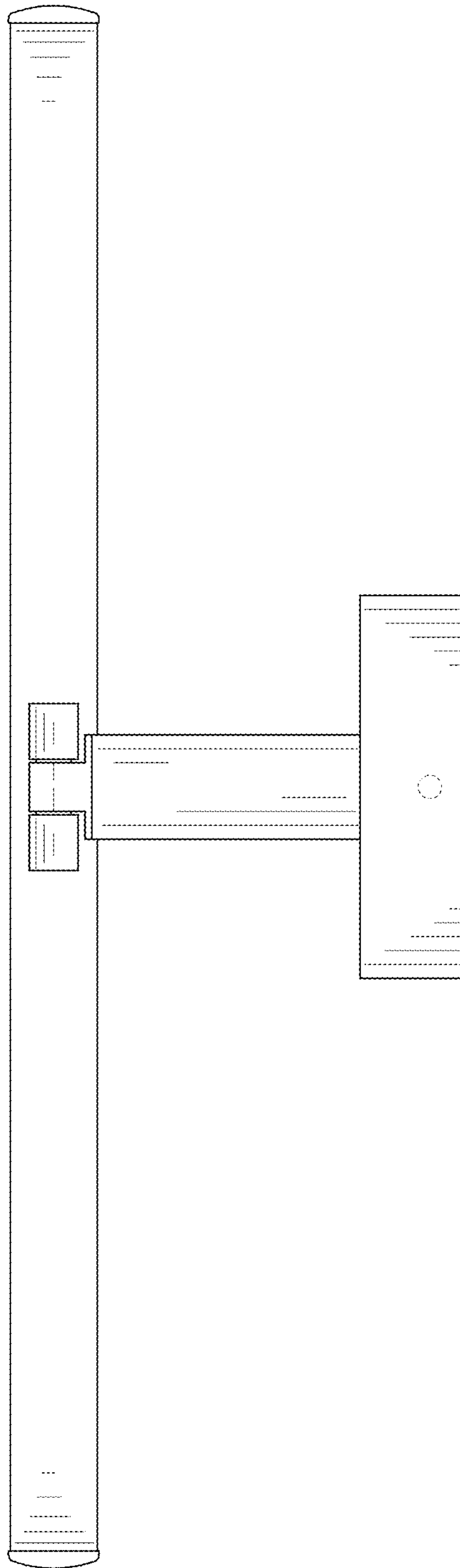

FIG. 3

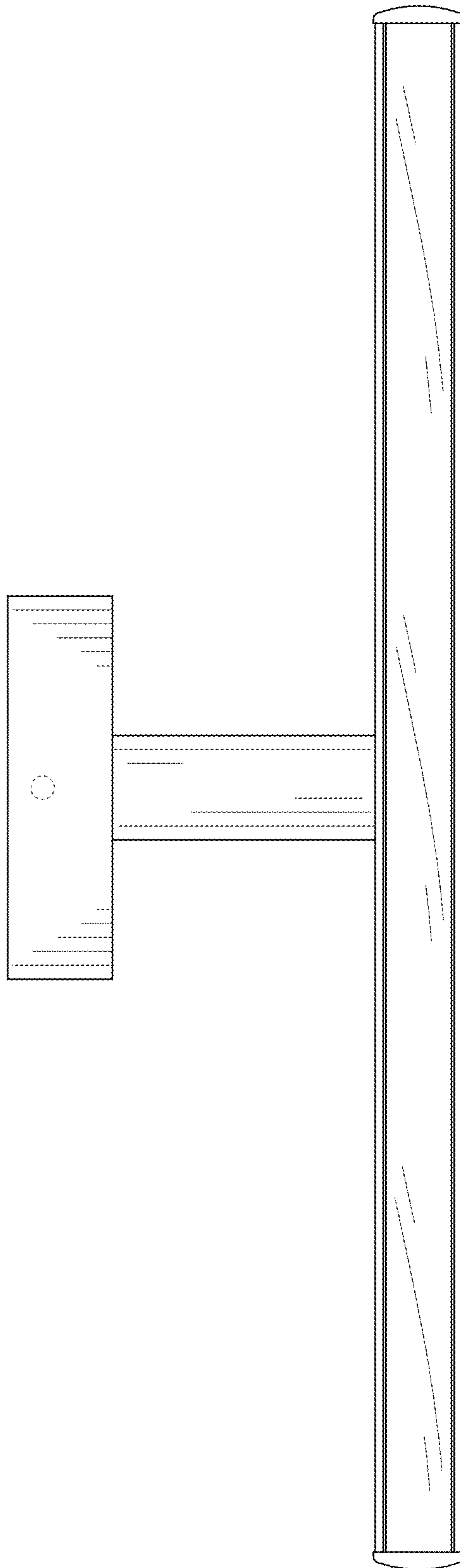

FIG. 4

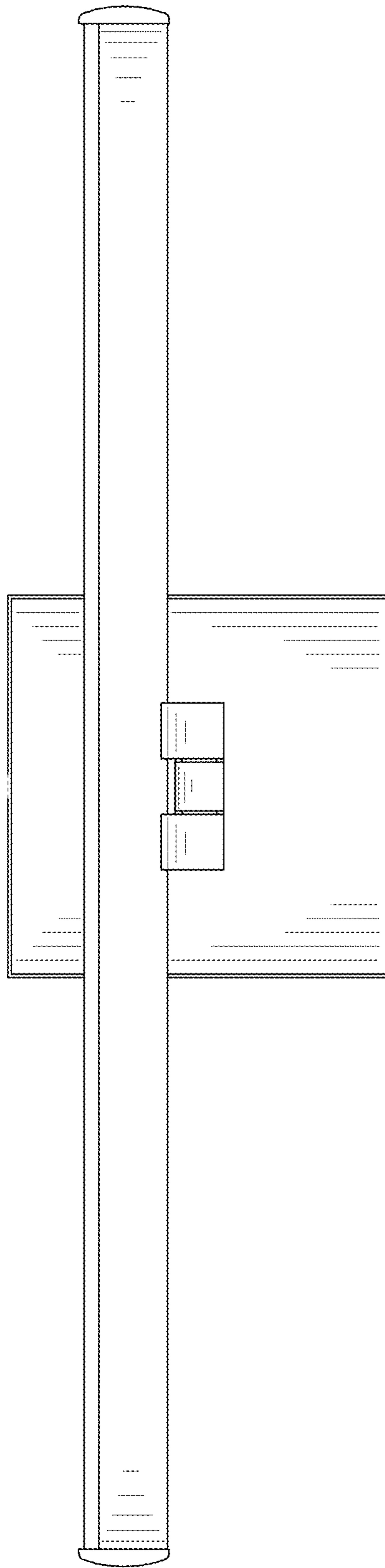

FIG. 5

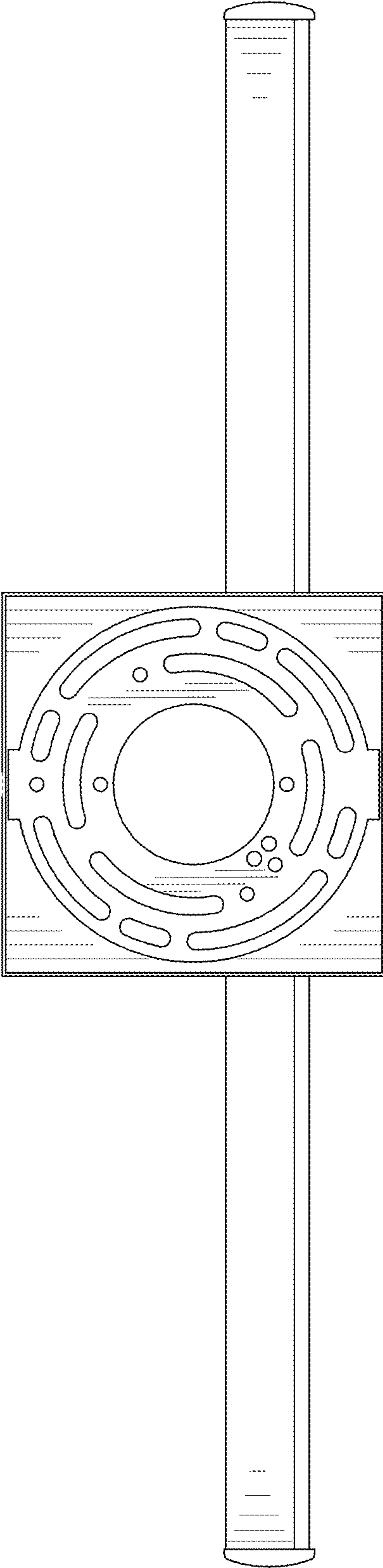

FIG. 6

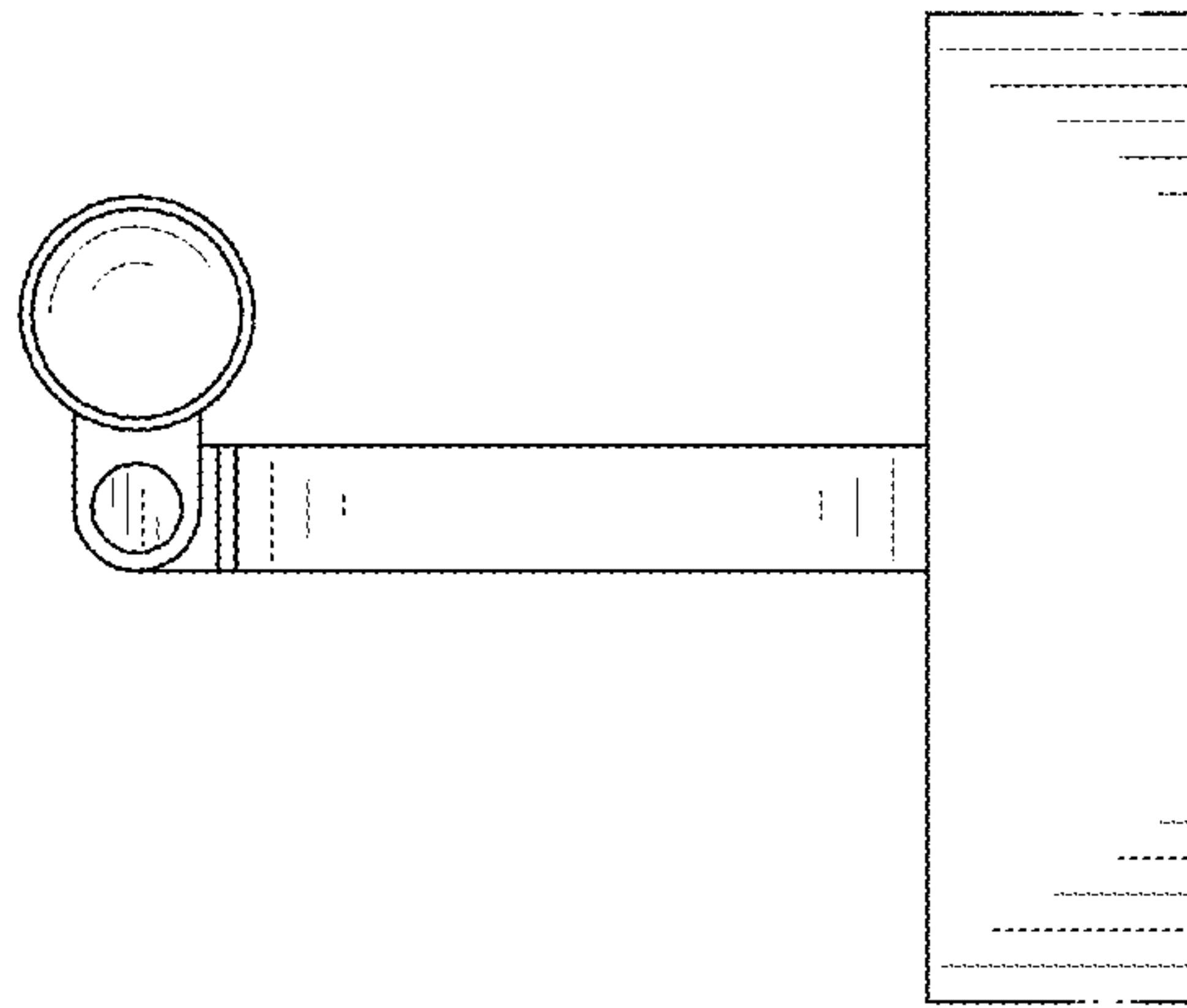

FIG. 7



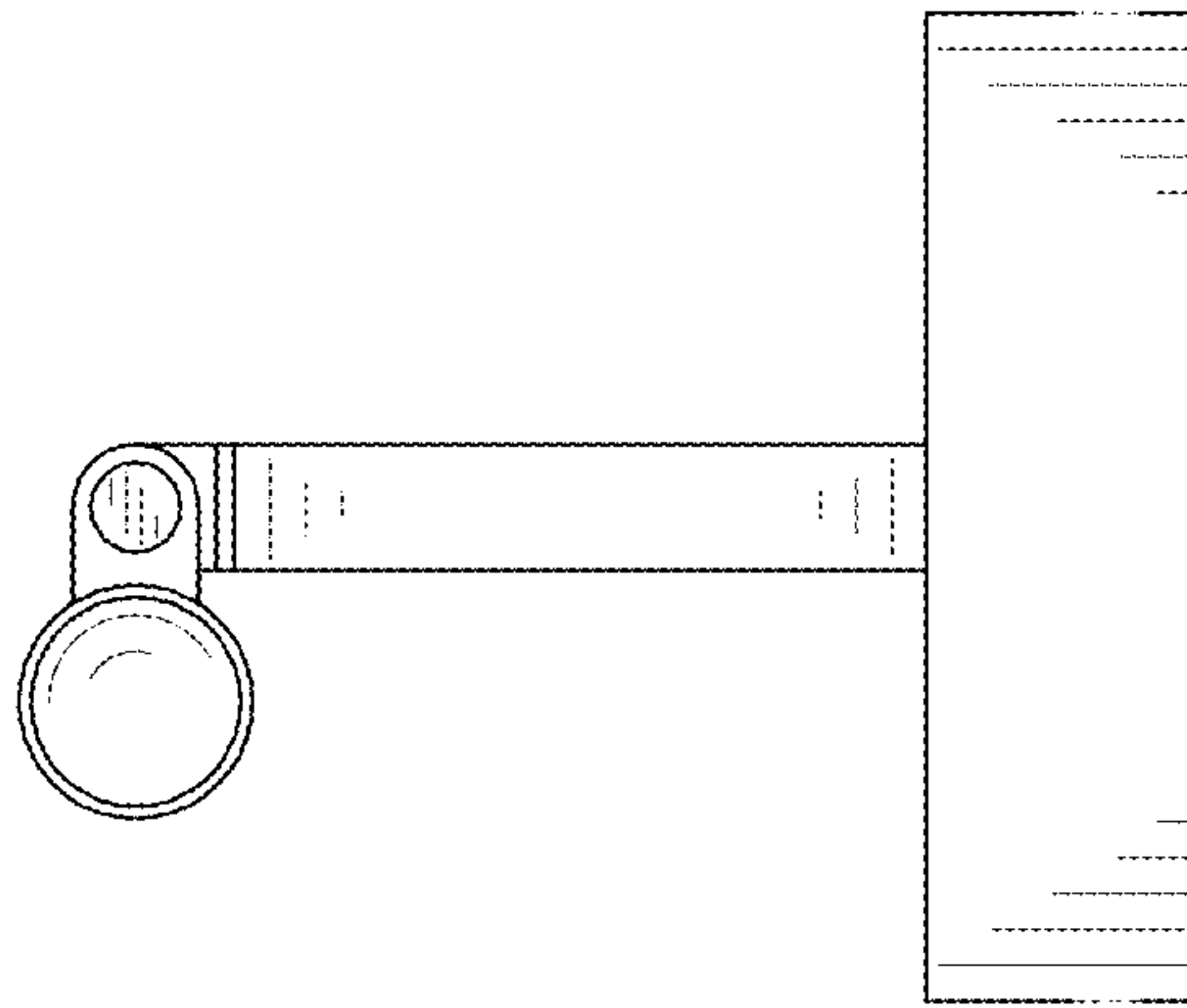

FIG. 8

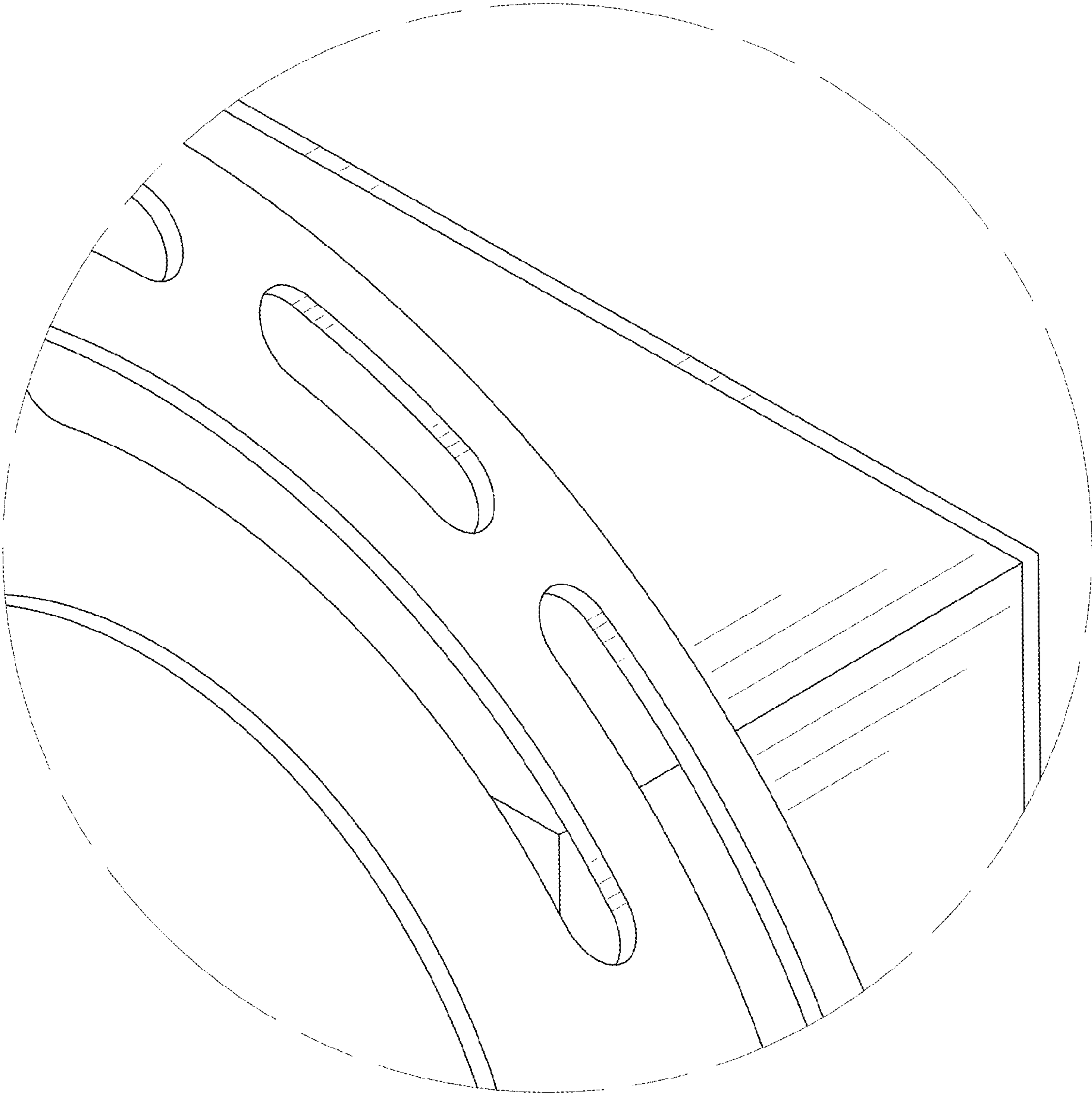

FIG. 9