



US00D973910S

(12) **United States Design Patent** (10) **Patent No.:** **US D973,910 S**  
**Behere et al.** (45) **Date of Patent:** **\*\* Dec. 27, 2022**

(54) **CRITICAL CARE SUITE**  
(71) Applicant: **KONINKLIJKE PHILIPS N.V.**,  
Eindhoven (NL)  
(72) Inventors: **Sachin Suresh Behere**, Singapore (SG);  
**Nigel Geh Keong Teck**, Singapore  
(SG)  
(73) Assignee: **KONINKLIJKE PHILIPS N.V.**,  
Eindhoven (NL)

D253,246 S \* 10/1979 O'Toole ..... D24/185  
4,338,485 A \* 7/1982 Fullenkamp ..... A47B 79/00  
220/4.31  
D302,502 S \* 8/1989 Durham, Jr. .... D6/718.14  
D303,743 S \* 10/1989 Durham, Jr. .... D6/718.14  
D359,988 S \* 7/1995 Lechleiter ..... D20/10  
D360,230 S \* 7/1995 Lechleiter ..... D6/332  
D365,467 S \* 12/1995 Lechleiter ..... D6/332  
D385,044 S \* 10/1997 Johnson ..... D25/58  
D496,734 S \* 9/2004 Konishi ..... D25/1  
D530,104 S \* 10/2006 Saffell ..... D6/332  
D539,056 S \* 3/2007 Helmetag ..... D6/672  
D647,938 S \* 11/2011 Geddes ..... D16/215

(Continued)

(\*\*) Term: **15 Years**

(21) Appl. No.: **29/712,455**

(22) Filed: **Nov. 8, 2019**

(30) **Foreign Application Priority Data**

May 8, 2019 (EM) ..... 006431714

(51) **LOC (13) Cl.** ..... **25-02**

(52) **U.S. Cl.**  
USPC ..... **D25/58; D6/332; D6/673**

(58) **Field of Classification Search**  
USPC .... D25/1, 3-35, 58; D6/640-644, 332, 677,  
D6/718.14, 672, 336, 664, 673; D24/185;  
D16/215; D20/10  
CPC .... E04H 1/00-12; E04H 1/1205-1277; E04H  
1/14; E04H 2001/1294  
See application file for complete search history.

(56) **References Cited**

**U.S. PATENT DOCUMENTS**

D202,771 S \* 11/1965 Wokas ..... D25/31  
D214,888 S \* 8/1969 Stewart ..... D25/16  
D221,629 S \* 8/1971 King ..... D25/16  
D223,440 S \* 4/1972 Noyes ..... D25/31  
D239,570 S \* 4/1976 Hall ..... D24/185  
D241,549 S \* 9/1976 Rota ..... D24/185  
D242,832 S \* 12/1976 Swensson ..... D6/644

**FOREIGN PATENT DOCUMENTS**

JP D2006-11549 \* 11/2006  
KR 300769720.0001 \* 1/2015

**OTHER PUBLICATIONS**

Tracy Block, 3 New Idea for Entertaining in Orlando, Feb. 8, 2018, Bizbash, <https://www.bizbash.com/venues-destinations/united-states/orlando-central-florida/media-gallery/13482618/3-new-ideas-for-entertaining-in-orlando> (Year: 2018).\*

(Continued)

*Primary Examiner* — Brett Miller

(57) **CLAIM**

The ornamental design for a critical care suite, as shown.

**DESCRIPTION**

FIG. 1 is a perspective view showing my design;  
FIG. 2 is a front elevational view thereof;  
FIG. 3 is a rear elevational view thereof;  
FIG. 4 is a right side elevational view thereof;  
FIG. 5 is a left side elevational view thereof;  
FIG. 6 is a top plan view thereof; and,  
FIG. 7 is a bottom plan view thereof.

**1 Claim, 5 Drawing Sheets**

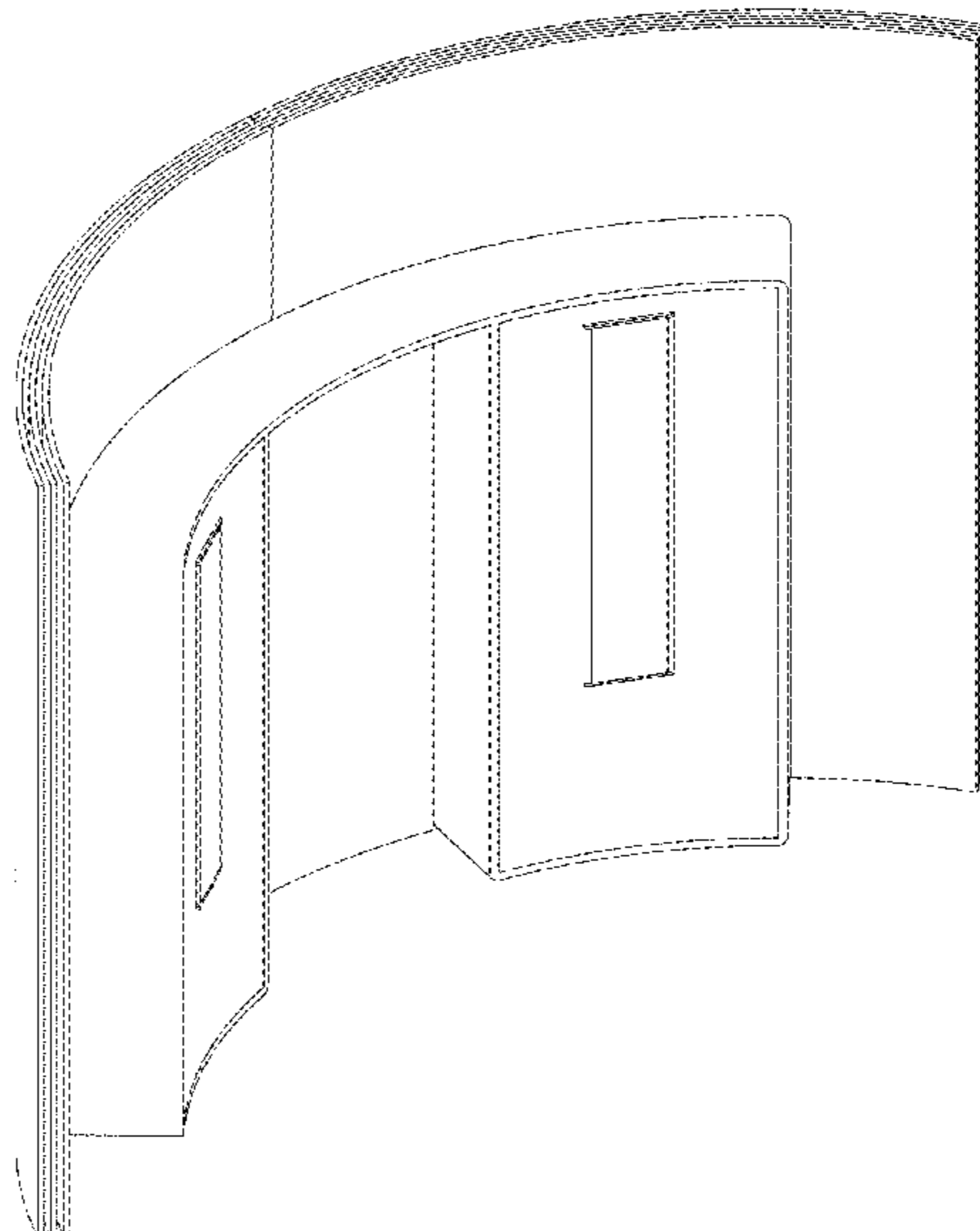

(56)

**References Cited**

## U.S. PATENT DOCUMENTS

D659,427 S \* 5/2012 Nicolas ..... D6/644  
D659,428 S \* 5/2012 Nicolas ..... D6/644  
D748,281 S \* 1/2016 Whitman ..... D25/16  
D754,875 S \* 4/2016 Baziuk ..... D25/31  
D774,318 S \* 12/2016 Tsuchiyama ..... D6/332  
D781,948 S \* 3/2017 Sebring ..... D16/215  
D785,374 S \* 5/2017 Holbrook ..... D6/643  
D787,704 S \* 5/2017 Walter ..... D25/16  
D791,513 S \* 7/2017 Holbrook ..... D6/643  
D791,967 S \* 7/2017 Goldberg ..... D25/16  
D812,671 S \* 3/2018 Sebring ..... D16/215  
D822,746 S \* 7/2018 Sebring ..... D16/215  
D825,001 S \* 8/2018 Henkel ..... D6/332  
D850,129 S \* 6/2019 Webb ..... D6/643  
2007/0186490 A1 \* 8/2007 Salemi ..... E04H 1/14  
52/27.5

## OTHER PUBLICATIONS

Brent Ehrlich, The Best Indoor LED Luminaires of 2016, 2016, BuildingGreen, <https://www.buildinggreen.com/product-review/best-indoor-led-luminaires-2016> (Year: 2016).\*

Karissa Rosenfield. "SOM breaks ground at The Christ Hospital in Cincinnati" Jul. 3, 2012. ArchDaily. Accessed Apr. 23, 2022. <<https://www.archdaily.com/250743/som-breaks-ground-at-the-christ-hospital-in-cincinnati>> (Year: 2012).\*

DBS Bank Office Photos, Aug. 2, 2017, Glassdoor, [https://www.glassdoor.co.in/Photos/DBS-Bank-Office-Photos-E611812\\_P2.htm](https://www.glassdoor.co.in/Photos/DBS-Bank-Office-Photos-E611812_P2.htm) (Year: 2017).\*

Pro Expo Exhibits, As the Booth Turns, Jan. 3, 2014, <https://tradeshowbestpractices.com/2014/01/03/as-the-booth-turns/> (Year: 2014).\*

\* cited by examiner

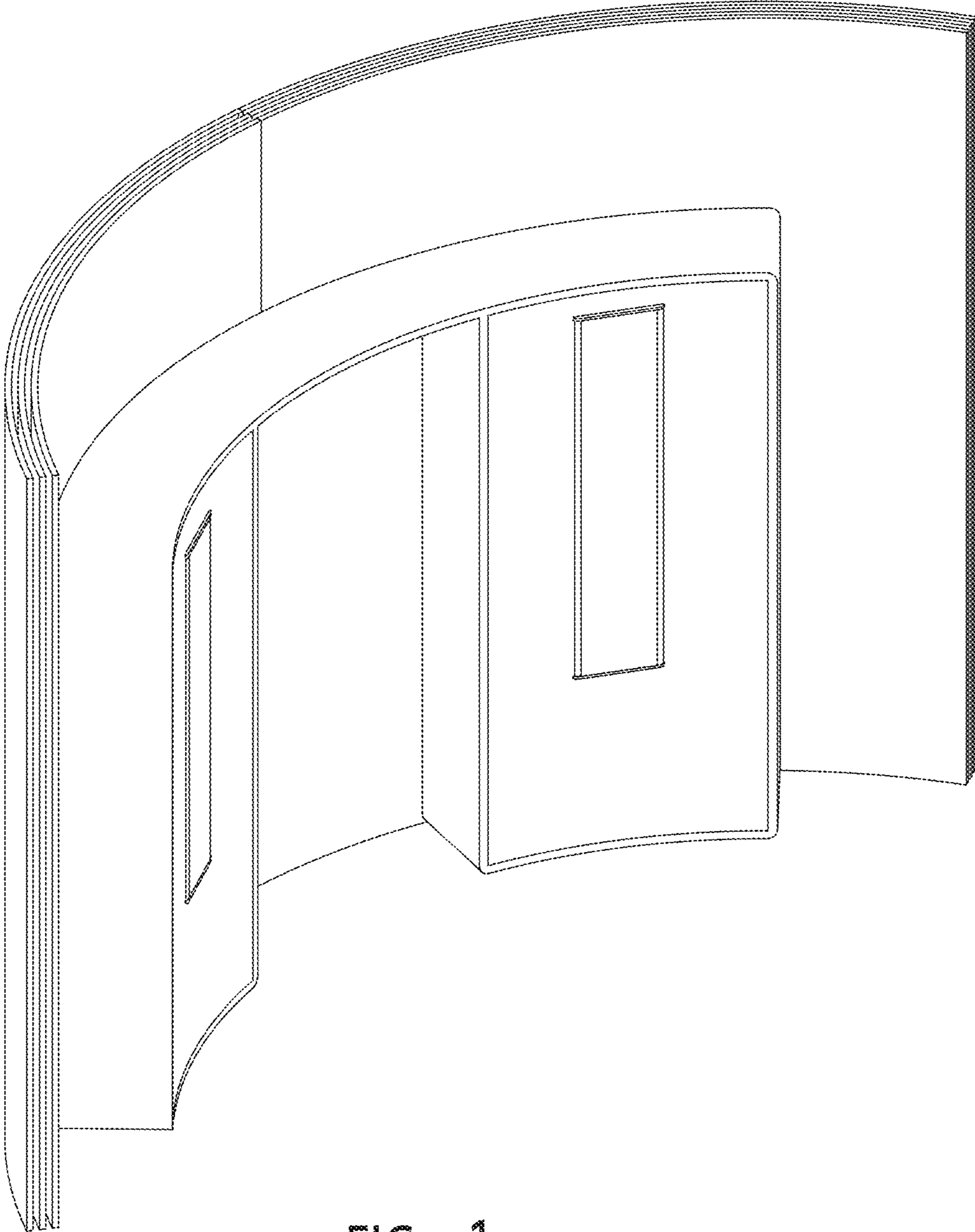

FIG. 1

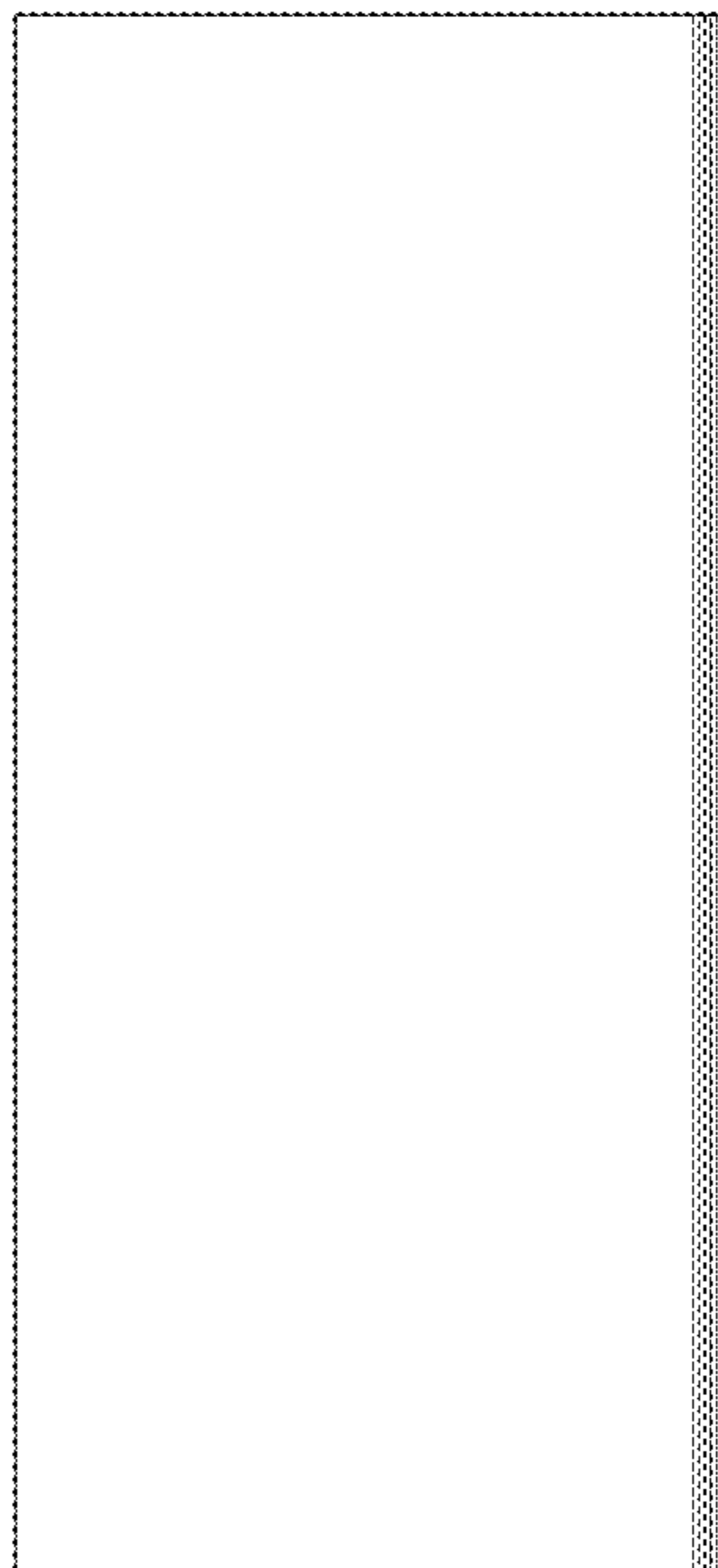

FIG. 2

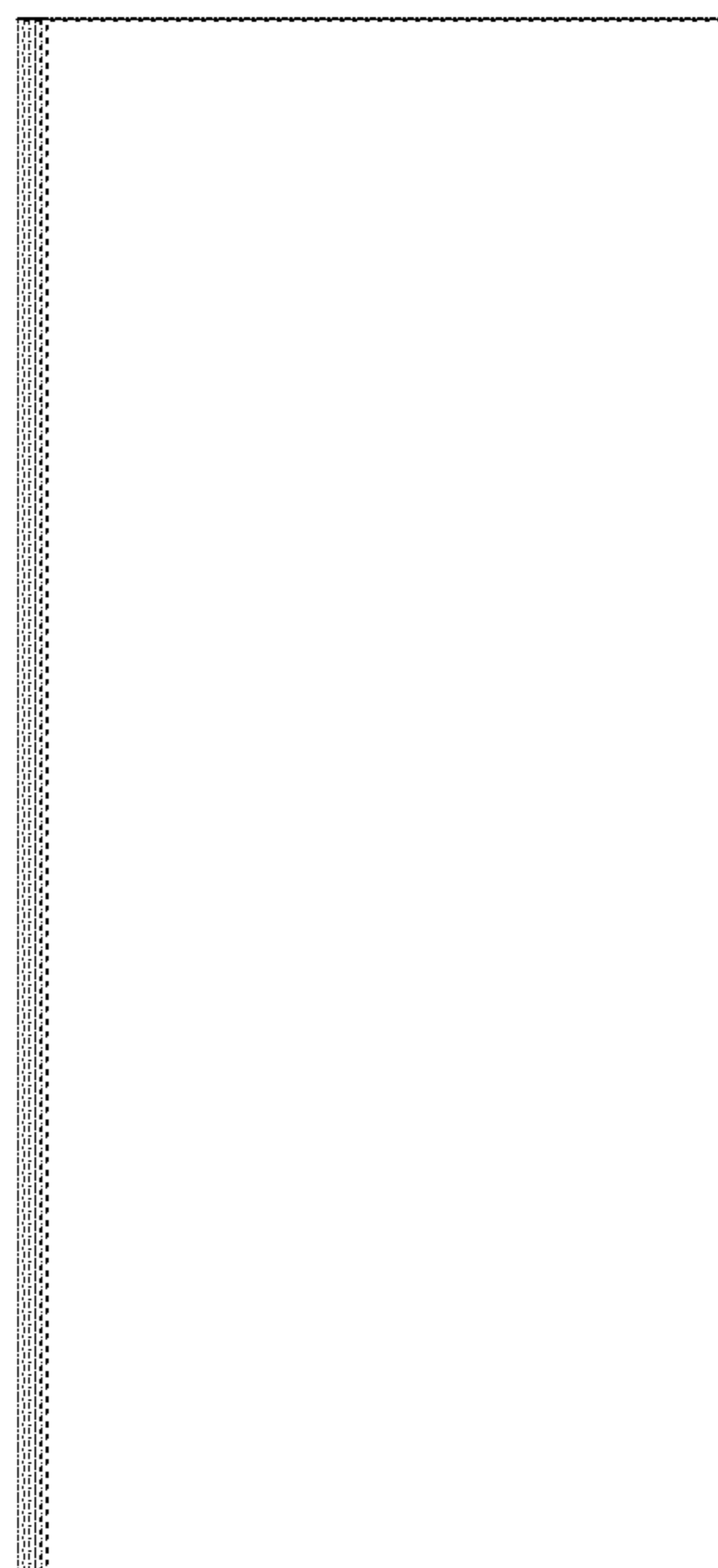

FIG. 3

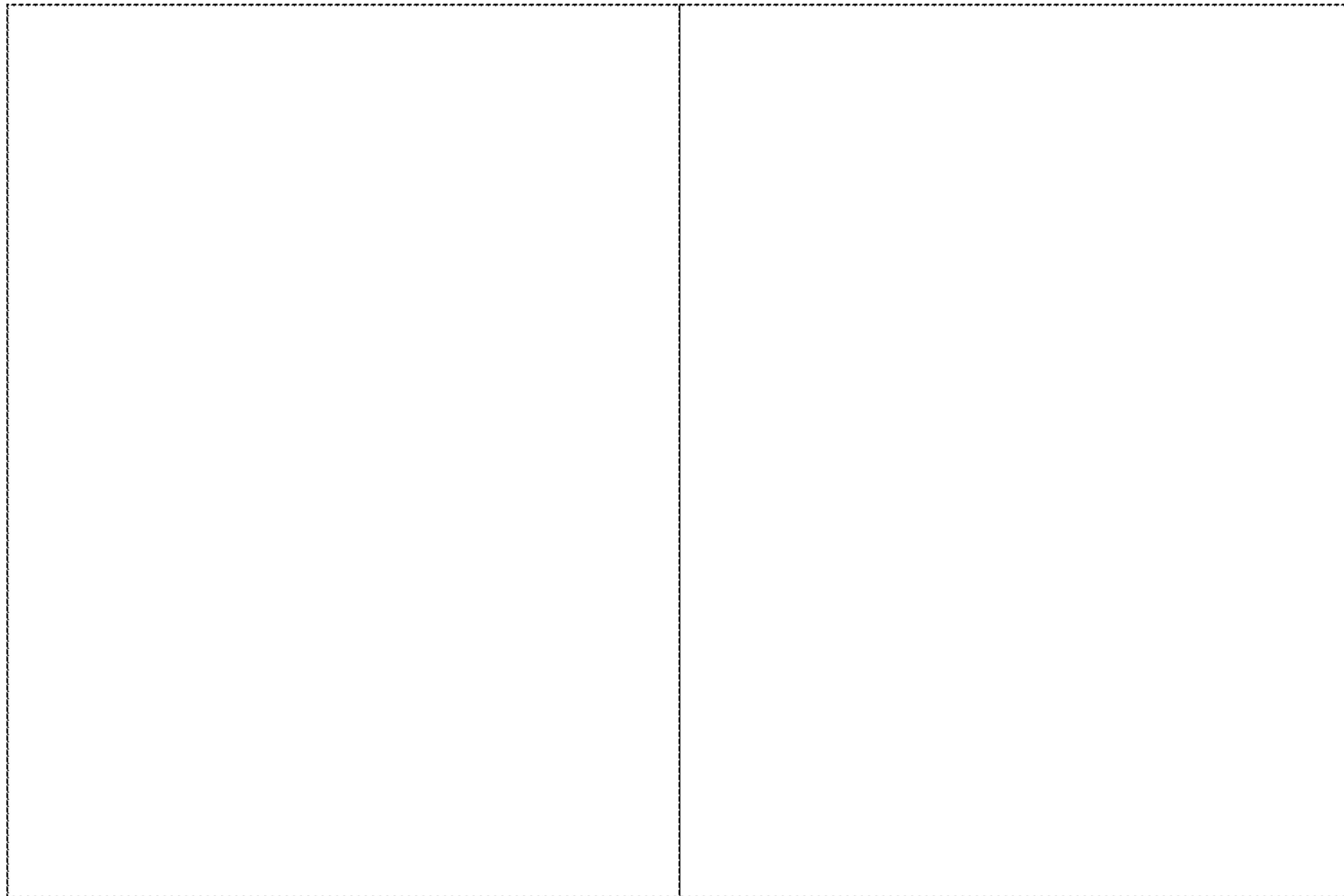

FIG. 4

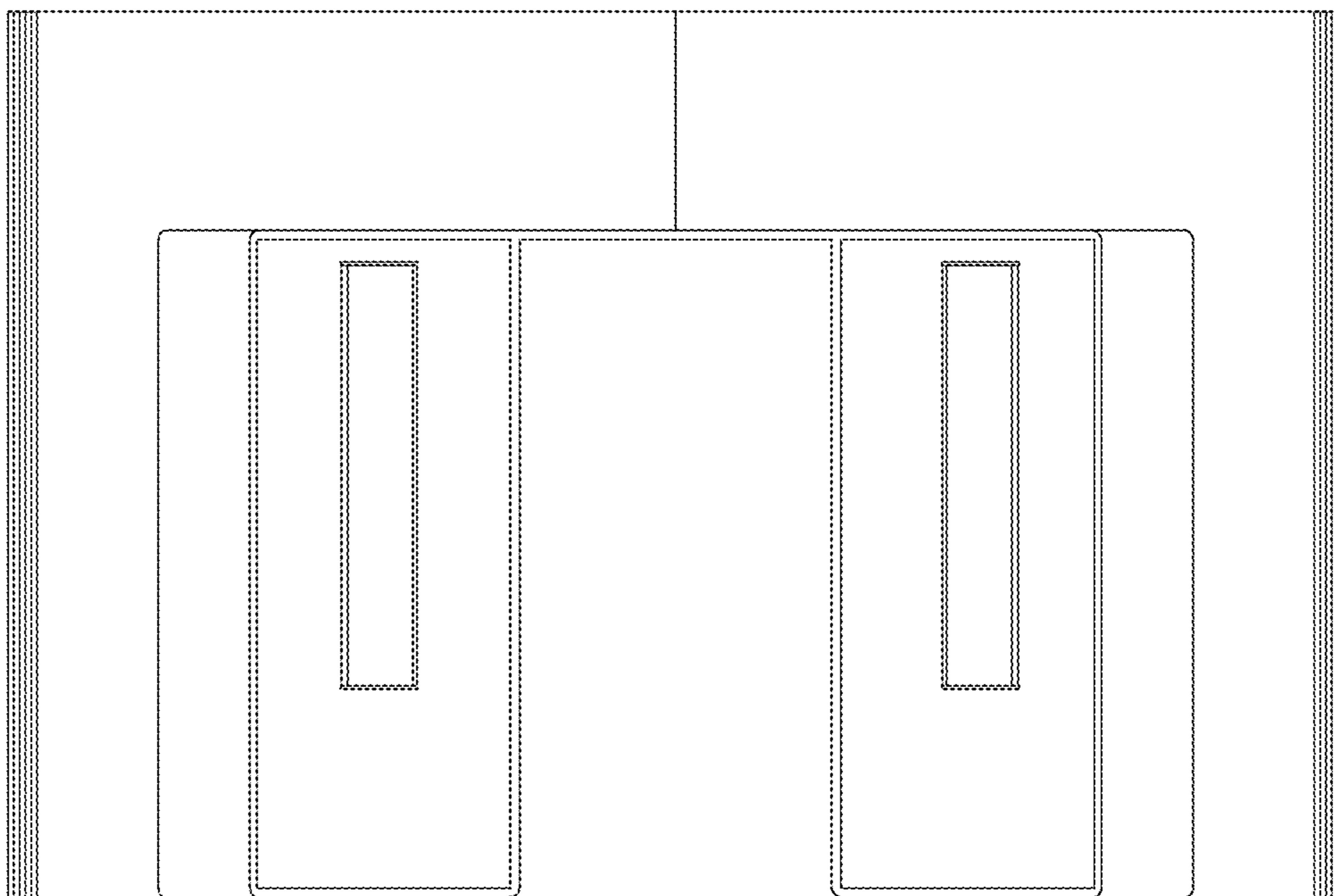

FIG. 5

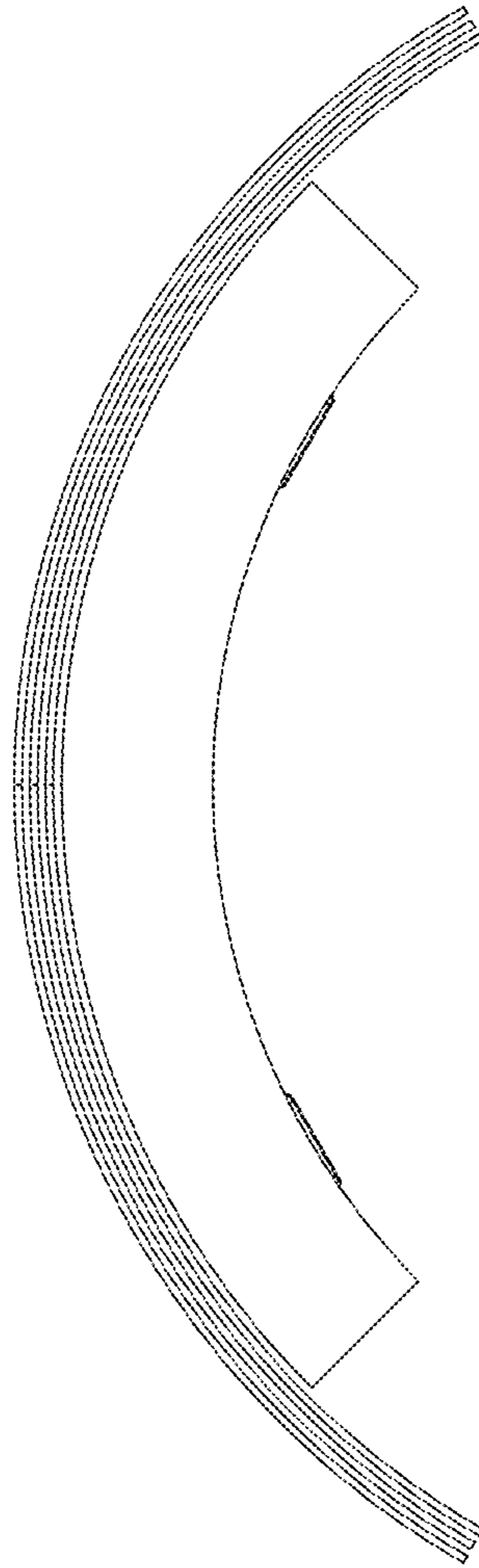

FIG. 6

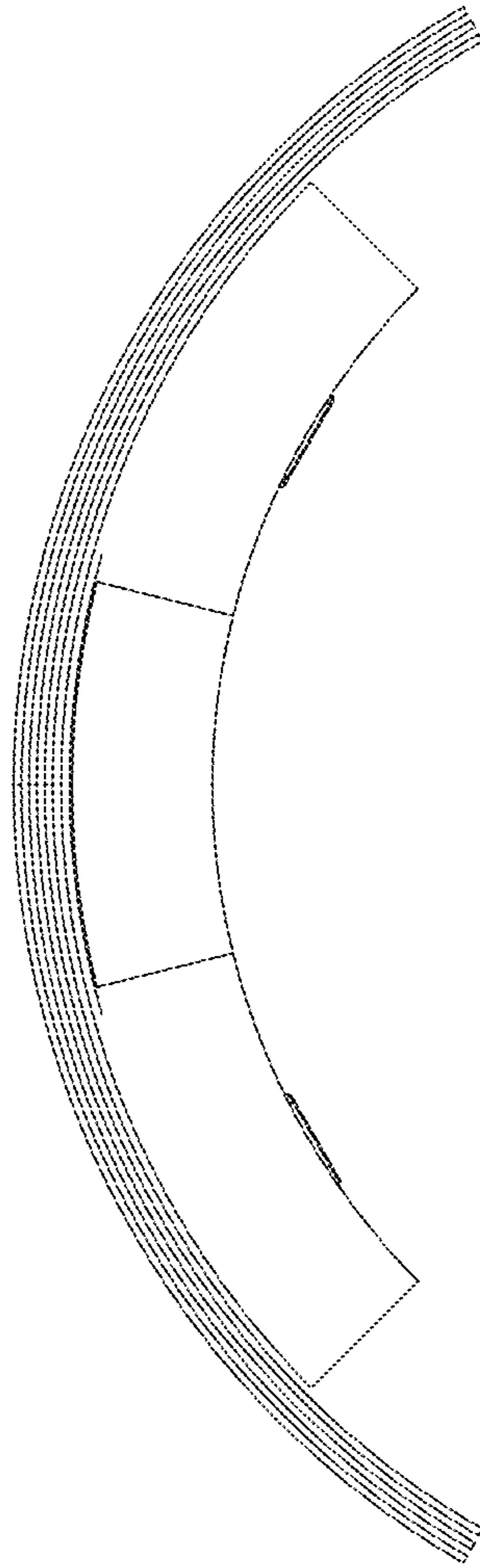

FIG. 7