

US00D973869S

(12) **United States Design Patent** (10) **Patent No.:** **US D973,869 S**
Chen (45) **Date of Patent:** **** Dec. 27, 2022**

(54) **TRANSPARENT TATTOO GRIP**
(71) Applicant: **IMPORTLA, LLC**, Orange, CA (US)
(72) Inventor: **Billy Chen**, Orange, CA (US)
(73) Assignee: **IMPORTLA, LLC**, Orange, CA (US)
(**) Term: **15 Years**
(21) Appl. No.: **29/833,443**
(22) Filed: **Apr. 4, 2022**

D609,339 S * 2/2010 Myers A61M 37/0076
D24/133
D631,960 S * 2/2011 Myers A61M 37/0076
D24/146
D677,790 S * 3/2013 Little A61M 37/0076
D24/146
D707,294 S * 6/2014 Casciotti D19/199
D721,806 S * 1/2015 Higgins D24/140
D722,692 S * 2/2015 Chen D24/144
D723,685 S * 3/2015 Myers A61M 37/0076
D24/144
D735,811 S * 8/2015 Laemle D19/192
(Continued)

Related U.S. Application Data

(62) Division of application No. 29/706,558, filed on Sep. 20, 2019.
(51) **LOC (13) Cl.** **24-02**
(52) **U.S. Cl.**
USPC **D24/127**; D24/133
(58) **Field of Classification Search**
USPC D24/112-114, 108, 130, 127, 187, 133,
D24/135, 140, 144, 145, 146, 147;
D19/174, 199
CPC A61M 5/178; A61M 5/20; A61M 5/31;
A61M 5/3146; A61M 5/3129; A61M
5/3148; A61M 5/315; A61M 3/00; A61M
37/0076; A61M 37/0084; A61M 37/0092
See application file for complete search history.

References Cited

U.S. PATENT DOCUMENTS

D344,132 S * 2/1994 Schneberger D9/683
D377,895 S * 2/1997 Theken D8/303
D380,046 S * 6/1997 Domanowski D19/903
D445,501 S * 7/2001 Niedospial, Jr. D24/129
D483,153 S * 12/2003 Jan D28/9
D568,543 S * 5/2008 Jan D28/9
D589,614 S * 3/2009 Cook D24/146
D598,095 S * 8/2009 Hansen A61M 37/0076
D24/144

OTHER PUBLICATIONS

TATSoul Wrath Gel Cartridge Grip, [site visited Mar. 7, 2022]. Available from Internet. URL: <https://www.youtube.com/watch?v=e4TZR0LBkRg> Jul. 25, 2019 (Year: 2019).*

Primary Examiner — T Chase Nelson
Assistant Examiner — Kelly L Gross

(74) *Attorney, Agent, or Firm* — Kevin Schraven; Anooj Patel; Hankin Patent Law, APC

(57) **CLAIM**

The ornamental design for a transparent tattoo grip, as shown and described.

DESCRIPTION

FIG. 1 is a top perspective view of a transparent tattoo grip showing my new design.
FIG. 2 is a left side elevational view thereof.
FIG. 3 is a right side elevational view thereof.
FIG. 4 is a front elevational view thereof.
FIG. 5 is a rear elevational view thereof.
FIG. 6 is a top plan view thereof; and,
FIG. 7 is a bottom plan view thereof.
The broken lines showing the grip pattern and trade name form no part of the claimed design.

1 Claim, 7 Drawing Sheets

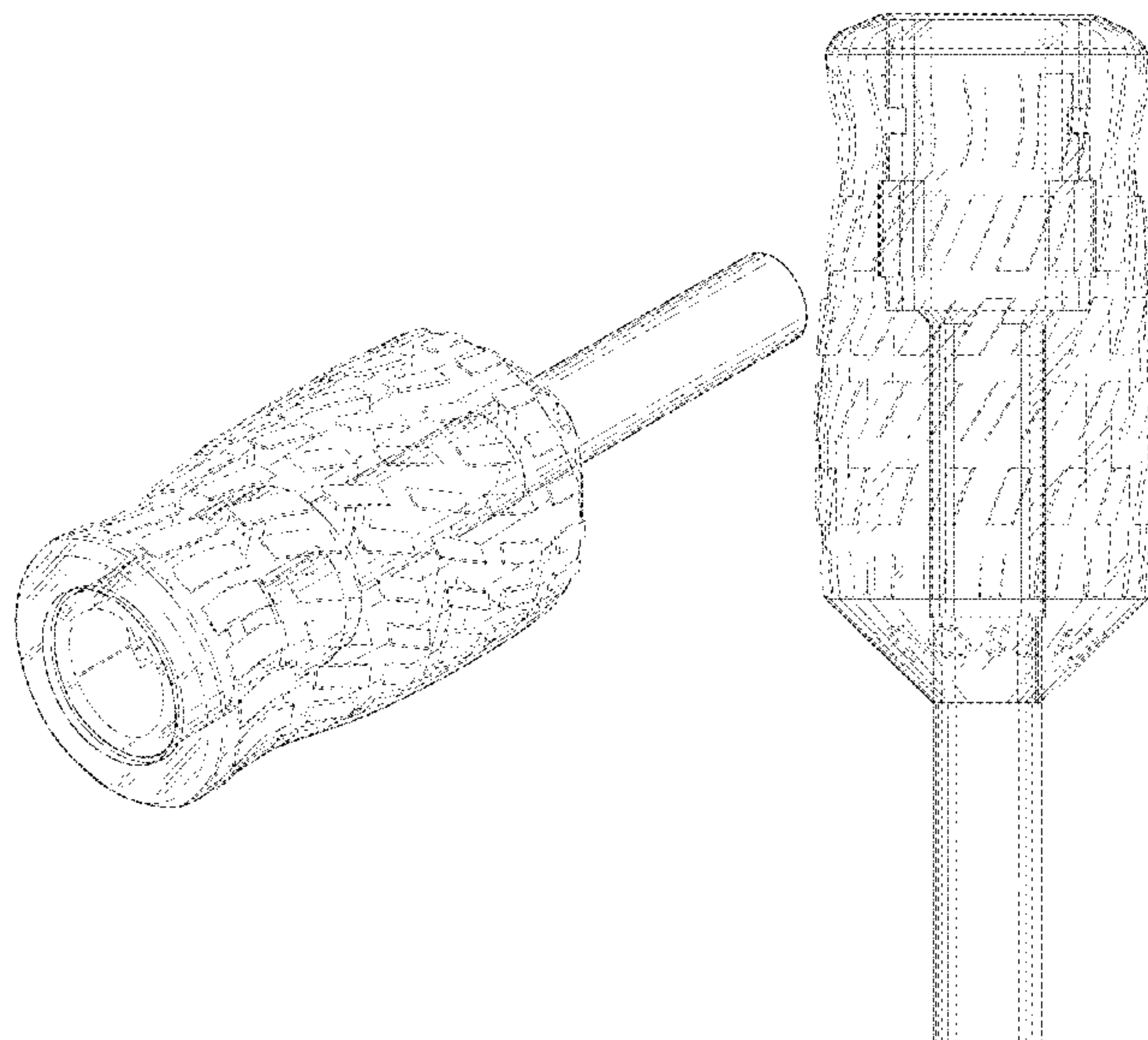

(56)

References Cited

U.S. PATENT DOCUMENTS

D745,151 S * 12/2015 Smith D24/144
D746,447 S * 12/2015 Wheeler D24/129
D746,455 S * 12/2015 Mayer A61M 37/0076
D24/144
D768,292 S * 10/2016 Maher D24/119
D782,118 S * 3/2017 Alferez D29/114
D816,217 S * 4/2018 Naughton D24/130
D818,182 S * 5/2018 Logothetis D26/113
D826,330 S * 8/2018 Bo D19/173
D830,461 S * 10/2018 Li D19/904
D834,090 S * 11/2018 Xu D19/907
D852,016 S * 6/2019 Yoo D15/126
D852,953 S * 7/2019 Ciferri D24/144
D852,954 S * 7/2019 Ciferri D24/144
D881,385 S * 4/2020 Tiedeken D24/146
D883,477 S * 5/2020 Tiedeken A61M 37/0076
D24/146
D884,163 S * 5/2020 Tiedeken D24/146
D890,843 S * 7/2020 Fang D19/174
D893,712 S * 8/2020 Halseth D24/130
D893,716 S * 8/2020 Siciliano D24/144
D909,576 S * 2/2021 Wang D24/146
D909,577 S * 2/2021 Wang D24/146
D910,175 S * 2/2021 Tegowski D24/147
D926,016 S * 7/2021 Chisholm D24/144
D928,315 S * 8/2021 Morrison D24/146
D928,397 S * 8/2021 Liu D27/162
D934,422 S * 10/2021 Siciliano D24/144
D938,529 S * 12/2021 Wu D21/672
D939,086 S * 12/2021 Siciliano D24/144
D939,701 S * 12/2021 Siciliano D24/144
D939,703 S * 12/2021 Chen D24/146

* cited by examiner

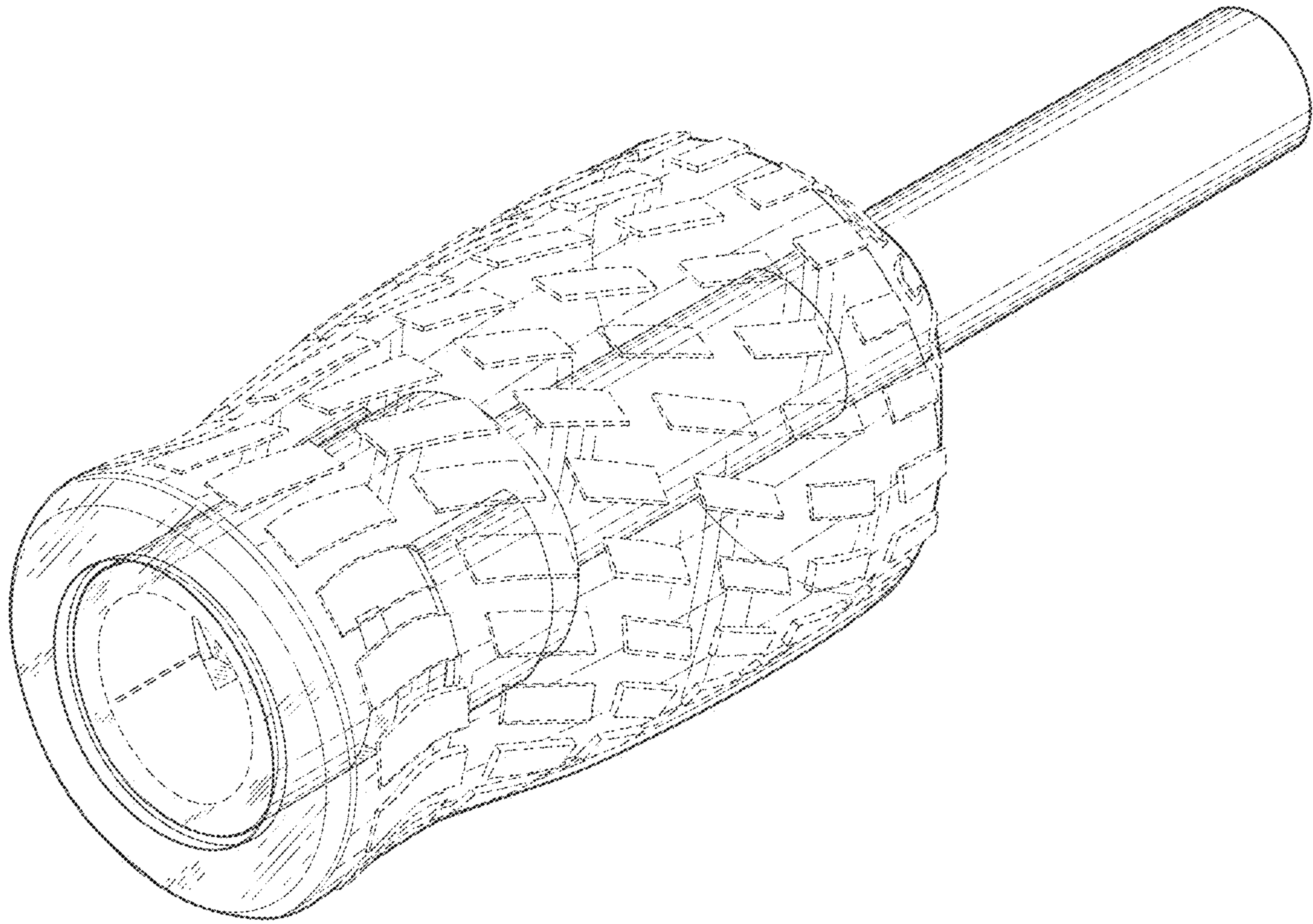

Fig. 1

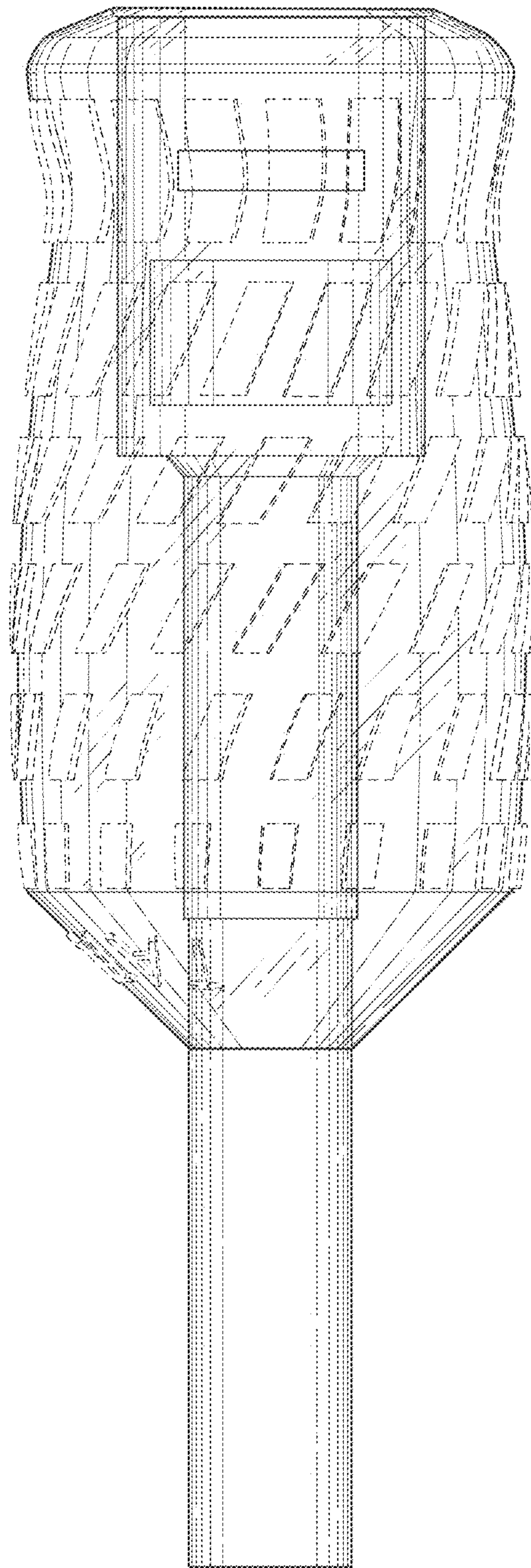

Fig. 2

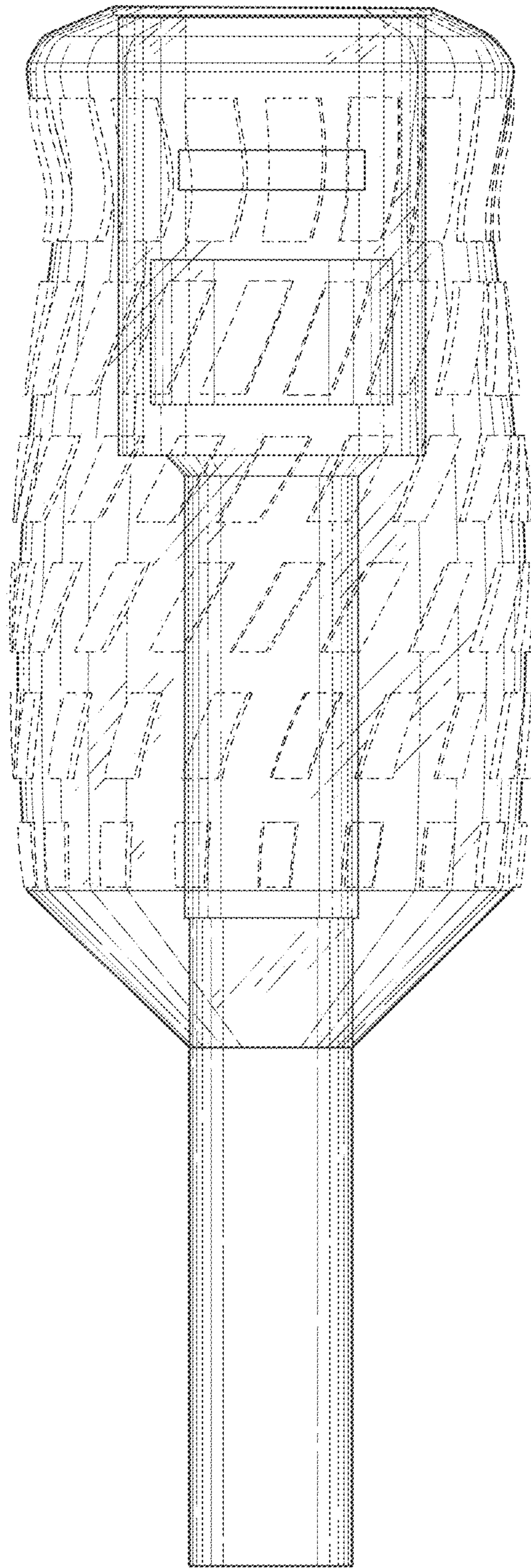

Fig. 3

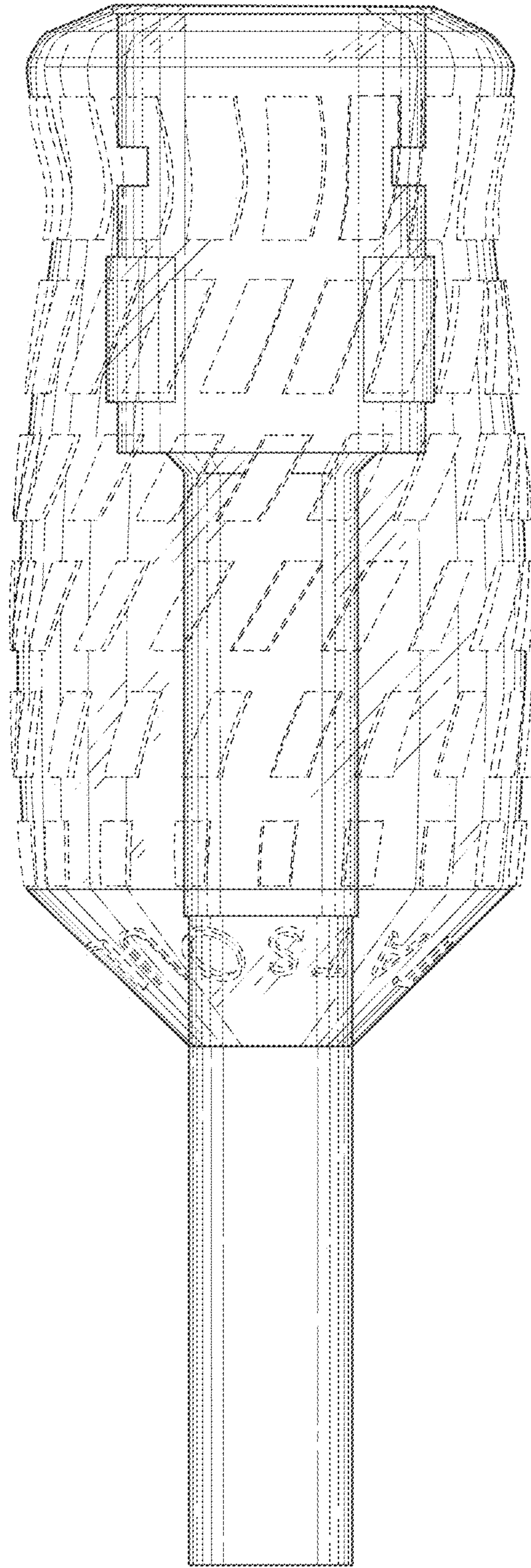

Fig.4

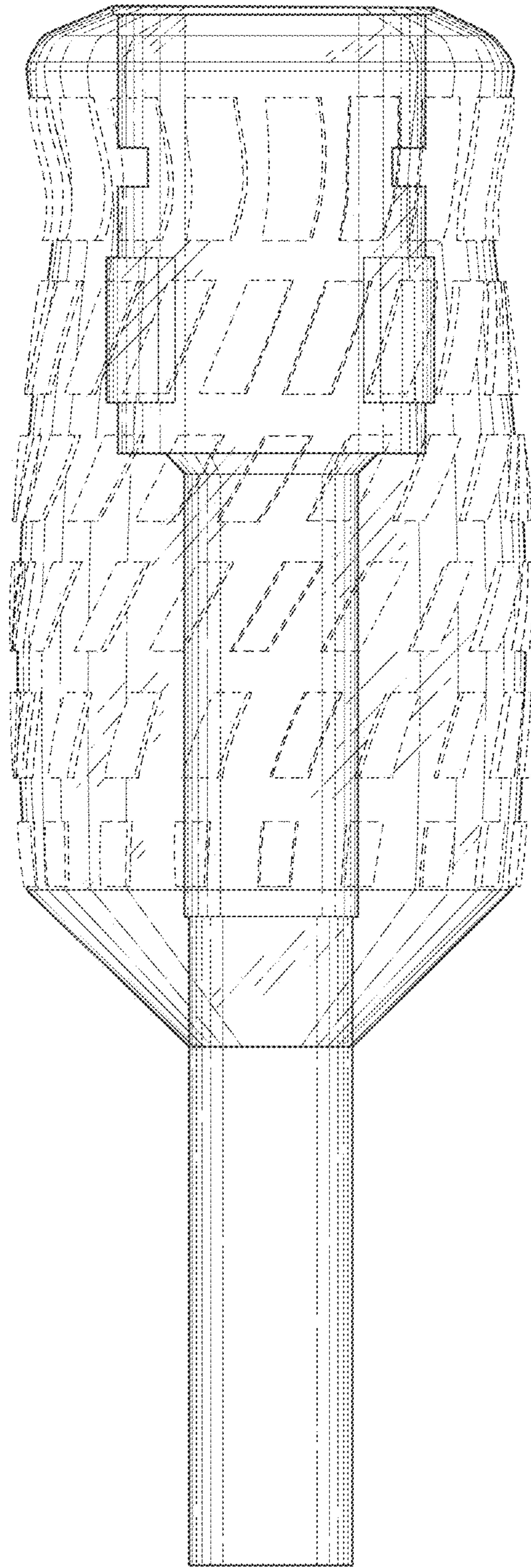

Fig. 5

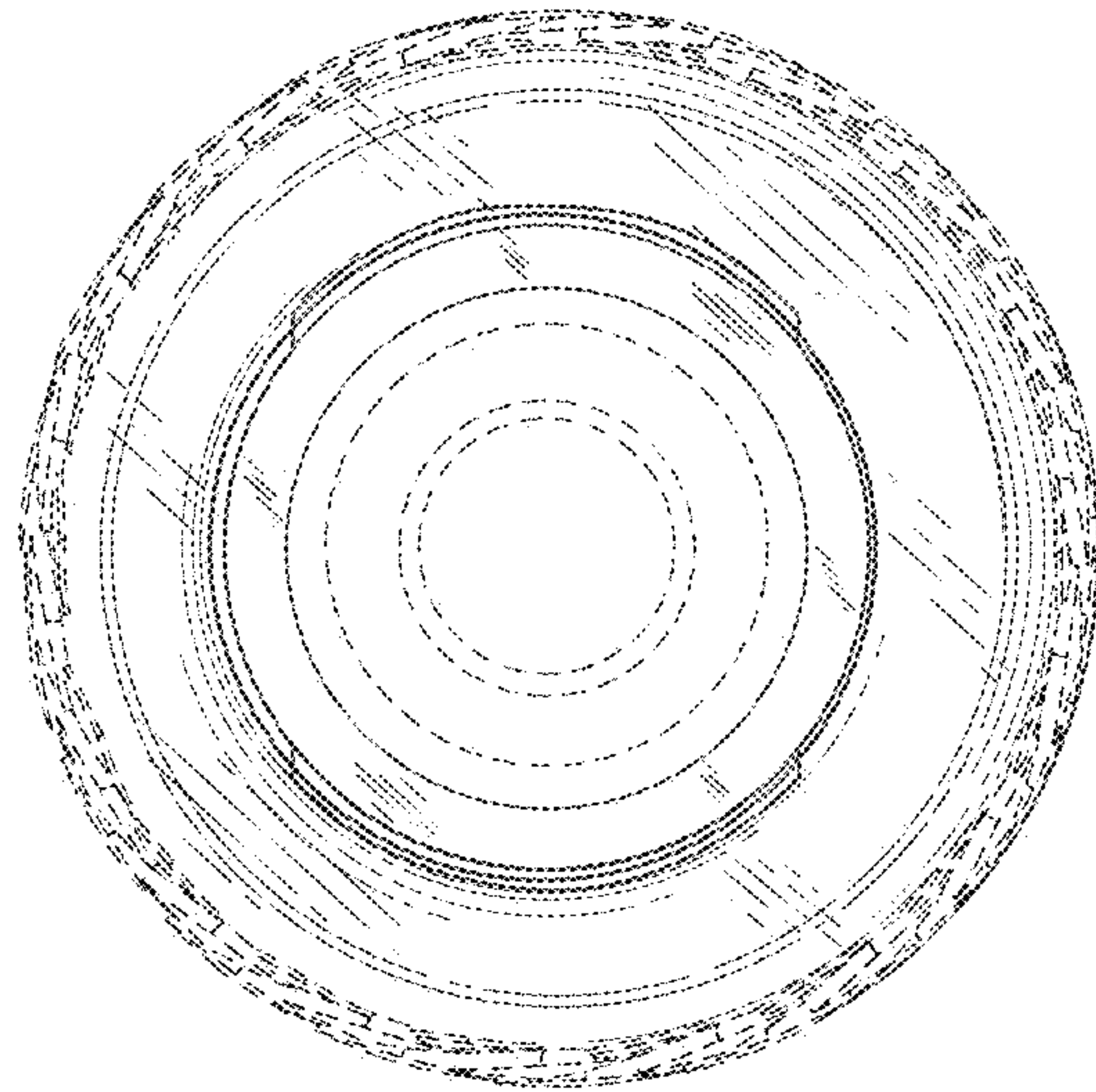

Fig.6

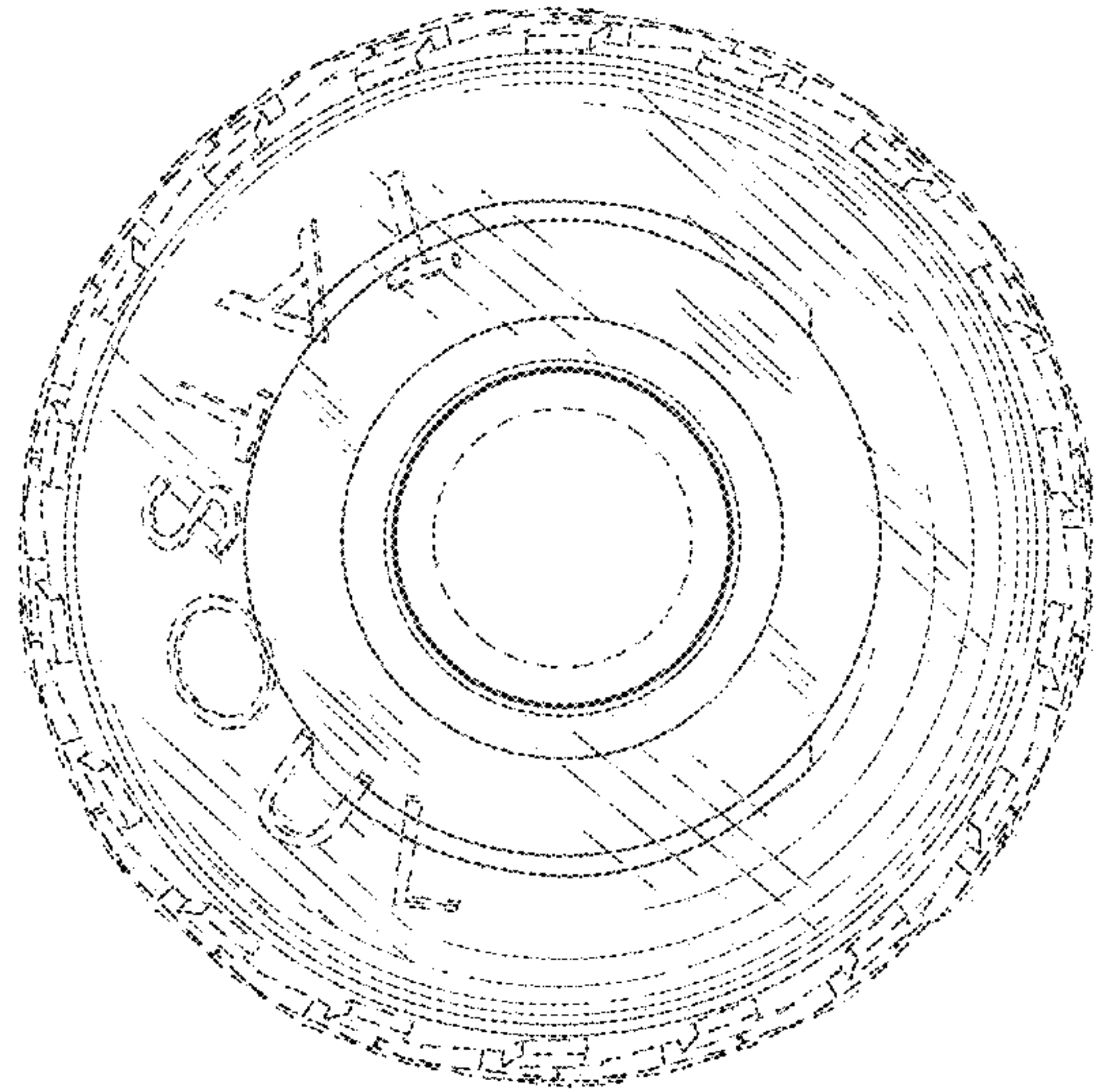

Fig. 7