



US00D973654S

(12) **United States Design Patent** (10) **Patent No.:** **US D973,654 S**
Li (45) **Date of Patent:** **** Dec. 27, 2022**

(54) **SUPERCOMPUTING DEVICE**

(71) Applicant: **BITMAIN TECHNOLOGIES INC.,**
Beijing (CN)

(72) Inventor: **Lianchen Li,** Beijing (CN)

(73) Assignee: **BITMAIN TECHNOLOGIES INC.,**
Beijing (CN)

(**) Term: **15 Years**

(21) Appl. No.: **29/668,367**

(22) Filed: **Oct. 30, 2018**

(51) **LOC (13) Cl.** **14-02**

(52) **U.S. Cl.**
USPC **D14/301**

(58) **Field of Classification Search**
USPC D14/300-304, 308-314, 328, 348-370,
D14/388, 432, 435, 439-446, 450,
(Continued)

(56) **References Cited**

U.S. PATENT DOCUMENTS

D335,652 S * 5/1993 Daniels D14/352
D366,461 S * 1/1996 Spechts D13/184
(Continued)

FOREIGN PATENT DOCUMENTS

CN 108646890 A * 10/2018 G06F 1/20
CN 210924370 U * 7/2020 G06F 1/18
(Continued)

OTHER PUBLICATIONS

Mitsuko, Shima et al., JP Design No. D1566196, published at Orbit,
publication date Dec. 26, 2016. Site visited May 7, 2021. Available
from Internet. (Year: 2016).*

(Continued)

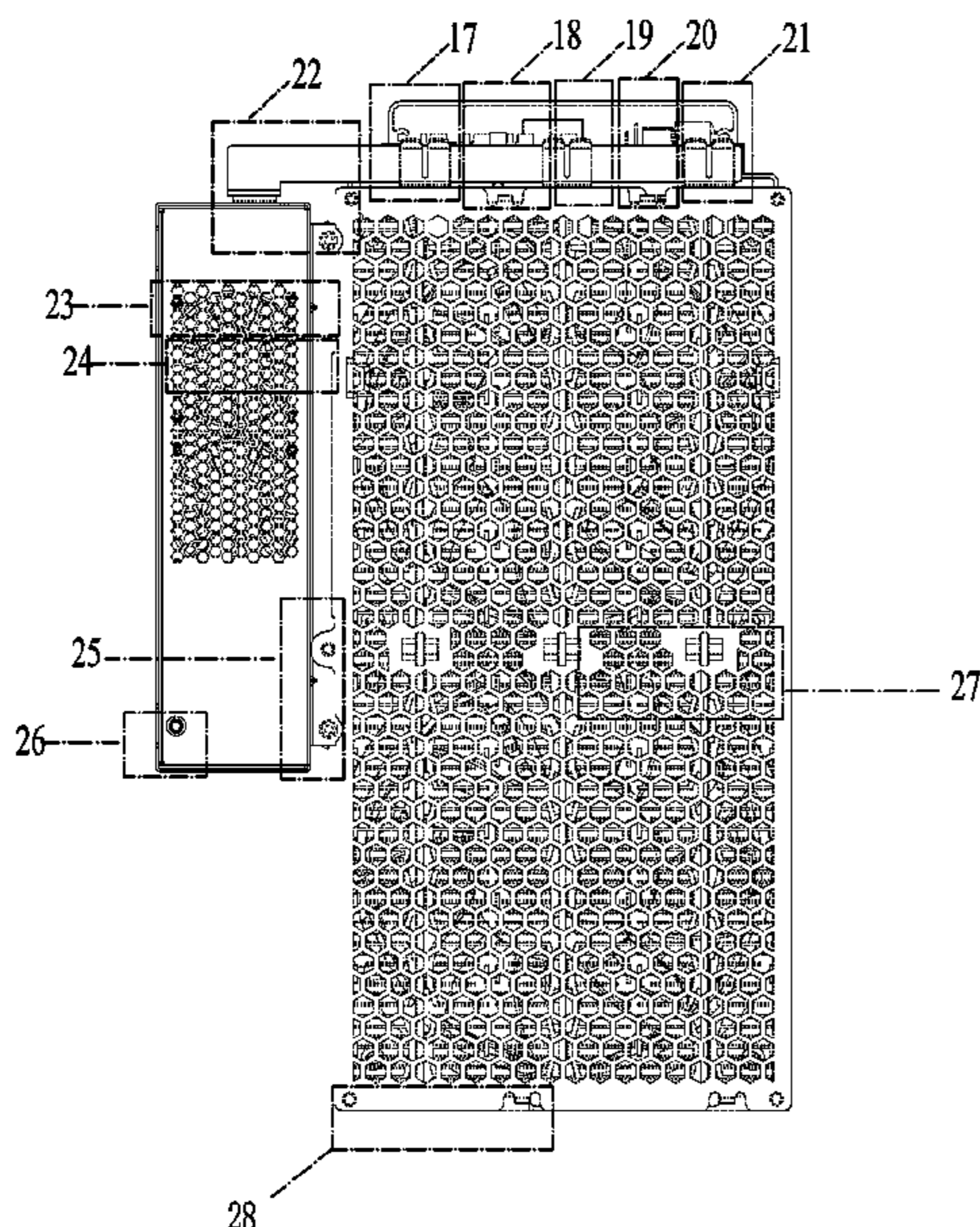

Primary Examiner — Kathleen L Jones

(74) Attorney, Agent, or Firm — J.C. Patents

(57) **CLAIM**

The ornamental design for a supercomputing device, as shown and described.

DESCRIPTION

FIG. 1 is a front view of a supercomputing device; FIG. 2 is a rear view of the supercomputing device; FIG. 3 is a left view of the supercomputing device; FIG. 4 is a right view of the supercomputing device; FIG. 5 is a top view of the supercomputing device; FIG. 6 is a bottom view of the supercomputing device; FIG. 7 is a perspective view of the supercomputing device; FIGS. 8 to 16 are detail views of the encircled portions on FIG. 1; FIGS. 17 to 28 are detail views of the encircled portions on FIG. 2; FIGS. 29 to 34 are detail views of the encircled portions on FIG. 3; FIGS. 35 to 46 are detail views of the encircled portions on FIG. 4; FIGS. 47 to 71 are detail views of the encircled portions on FIG. 5; FIGS. 72 to 82 are detail views of the encircled portions on FIG. 6; and, FIGS. 83 to 97 are detail views of the encircled portions on FIG. 7.

The evenly spaced broken lines depicting portions of the supercomputing device form no part of the claimed design. The line-dot-line broken lines that encircle portions of FIGS. 1-7 and that border the FIGS. 8-97 detail views indicate outer limits of enlarged areas of the figures and form no part of the claimed design.

1 Claim, 97 Drawing Sheets

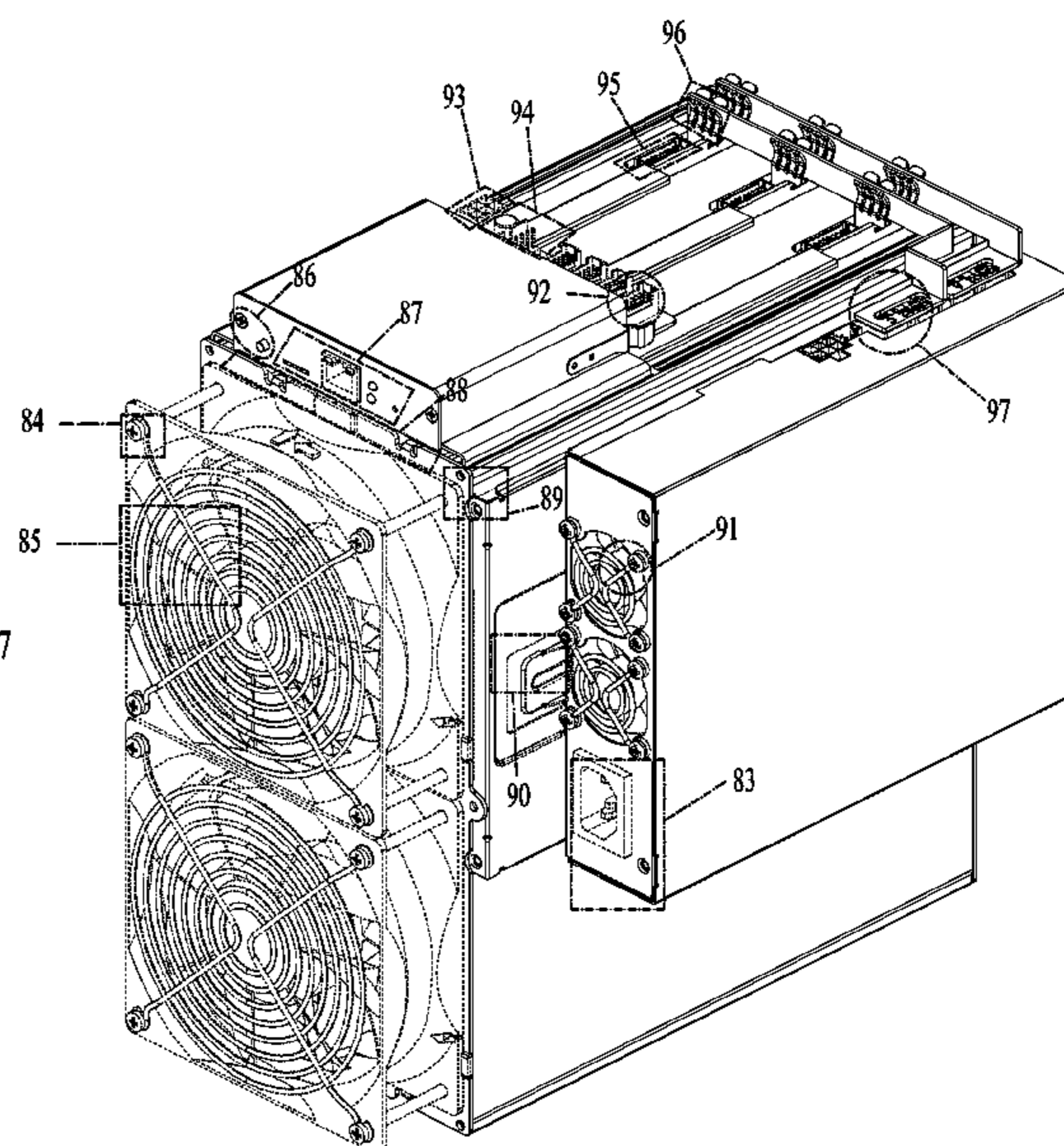

(58) **Field of Classification Search**

USPC D14/479–483, 140.1–140.4, 164, 193,
 D14/500–502, 257–258, 265; D13/184
 CPC G06F 1/16; G06F 1/1628; G06F 1/181;
 H05K 7/00; H05K 7/18; H05K 7/14;
 H05K 5/00; H05K 5/0004; H05K 5/0008;
 H05K 5/0021; H05K 5/0213; H05K
 5/012; H05K 5/0234
 See application file for complete search history.

(56) **References Cited**

U.S. PATENT DOCUMENTS

D379,351 S * 5/1997 Armstrong D14/363
 D379,623 S * 6/1997 Wu D14/352
 D379,973 S * 6/1997 Yoshimoto D14/308
 D399,191 S * 10/1998 Corrington D14/312
 D411,830 S * 7/1999 Chou D14/349
 D422,977 S * 4/2000 Hirose D13/162
 6,052,281 A * 4/2000 Hardt G06F 1/181
 361/679.33
 D431,556 S * 10/2000 Beaumont D13/184
 D464,973 S * 10/2002 Houdek D14/444
 D545,819 S * 7/2007 Chang D14/369
 D736,759 S * 8/2015 Yu D14/314
 D791,086 S * 7/2017 Balschat D13/162.1
 D843,996 S * 3/2019 Krivonak D14/300
 D919,614 S * 5/2021 Huang D14/314
 D935,466 S * 11/2021 Hermann D14/439
 2002/0145847 A1 * 10/2002 Crosby F16M 11/10
 361/679.02
 2005/0068723 A1 * 3/2005 Squillante G06F 1/181
 361/679.46
 2007/0285886 A1 * 12/2007 Huang G06F 1/1601
 361/679.49
 2012/0155027 A1 * 6/2012 Broome B66C 19/00
 361/696
 2018/0341297 A1 * 11/2018 Kinstle, III H05K 7/20209
 2021/0136960 A1 * 5/2021 Lan H05K 5/0213

FOREIGN PATENT DOCUMENTS

CN 210924370 U * 7/2020 G06F 1/181
 CN 112394780 A * 2/2021 G06F 1/18
 CN 112394781 A * 2/2021 G06F 1/18
 CN 112394782 A * 2/2021 G06F 1/18
 CN 112752457 B * 5/2022 H05K 5/0213
 CN 114679872 A * 6/2022
 CN 114531835 B * 7/2022
 EP 4064474 A1 * 9/2022 H05K 5/0213
 EP 4064806 A1 * 9/2022 G06F 1/186
 WO WO2020103155 A1 * 5/2020 G06F 1/18

OTHER PUBLICATIONS

Lilly, Paul, Bitmain Launches Ethereum ASIC Miner With Hash Rate Performance Of 8 GTX 1080 GPUs, posted at Hot Hardware, posting date Apr. 4, 2018. Site visted May 7, 2021. URL: <<https://hothardware.com/news/bitmain-launches-ethereum-asic-miner-hashrate-comparable-8-gtx-1080-gpus>> (Year: 2018).*

Admin, A Review on Bitmain's H1 2020, posted at Bitmain Blog, posting date Oct. 7, 2020. URL: <<https://blog.bitmain.com/en/category/bitmain-blog/crypto-pro/>> (Year: 2020).*

Buckley, Sean, Too poor for a new graphics card? Blame cryptocurrency, posted at CNet, posting date Jan. 30, 2018. Site visited May 7, 2021. URL: <<https://www.cnet.com/news/bitcoin-boom-pc-gaming-graphics-card/>> (Year: 2018).*

Thermaltake View 51 Snow Motherboard Sync ARGB E-ATX Full Tower Gaming Computer Case, posted at Amazon, posting date Jan. 23, 2020. Site visited May 7, 2021. URL: <<https://www.amazon.com/Thermaltake-Motherboard-Computer-Pre-Installed-CA-1Q6-00M6WN-00/dp/B08451HJGG?th=1>> (Year: 2020).*

Japanese document No. HC2700927900 published by PFU on Sep. 30, 2015, cited in the Japanese Notice of Allowance.

Japanese document No. HB2100013200 published by Cahners Publishing Company on Feb. 5, 2009, cited in the Japanese Notice of Allowance.

* cited by examiner

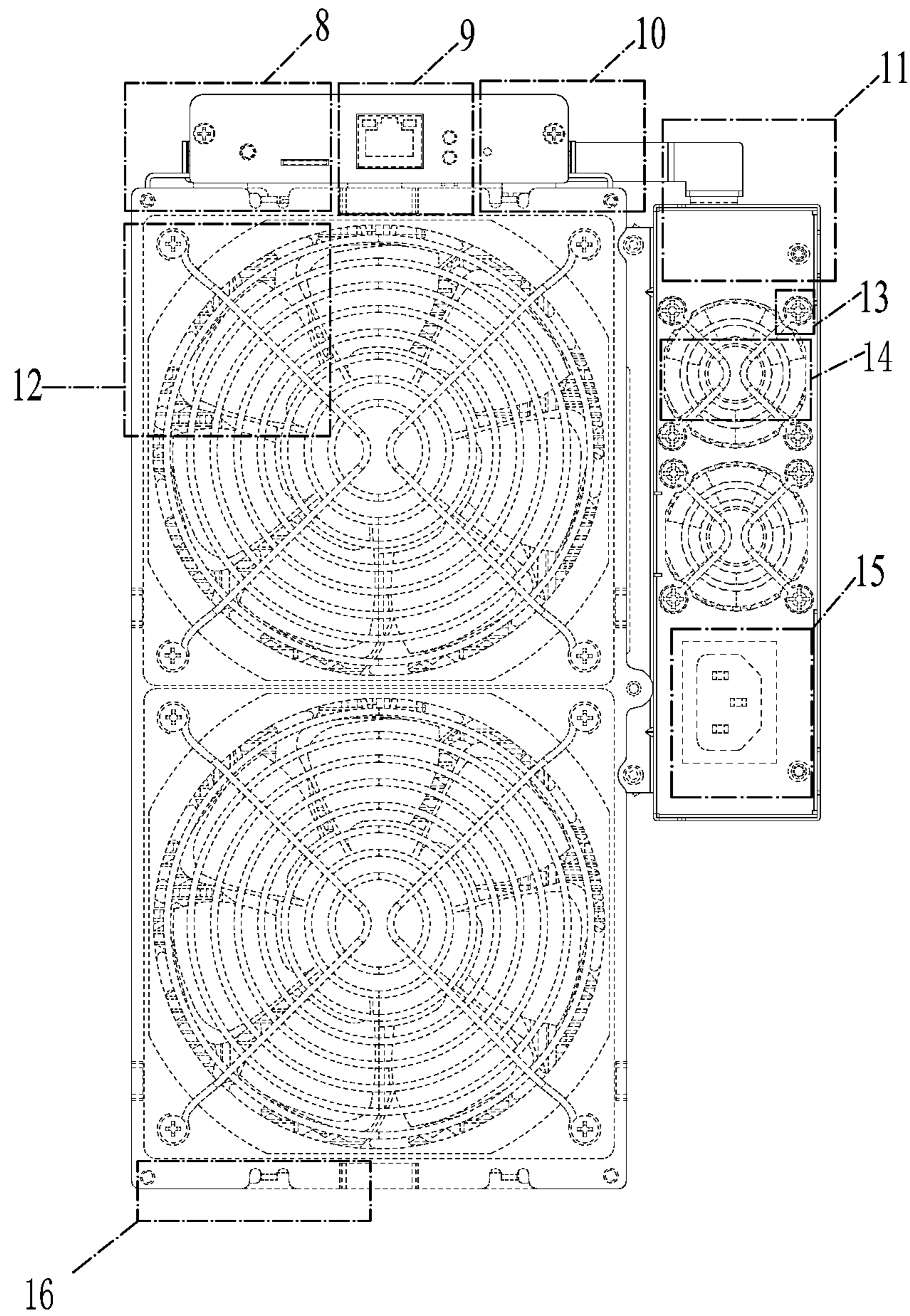

FIG. 1

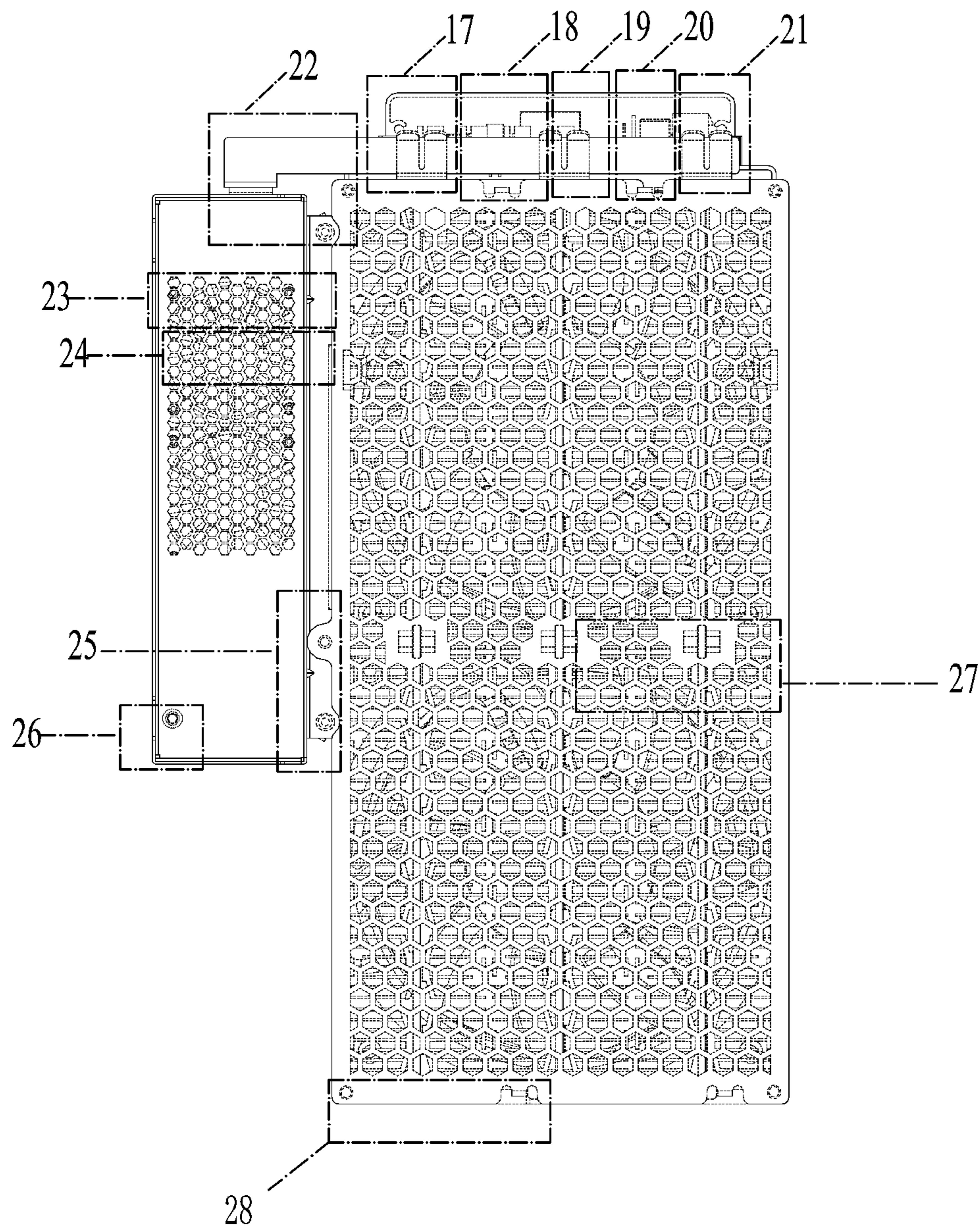

FIG. 2

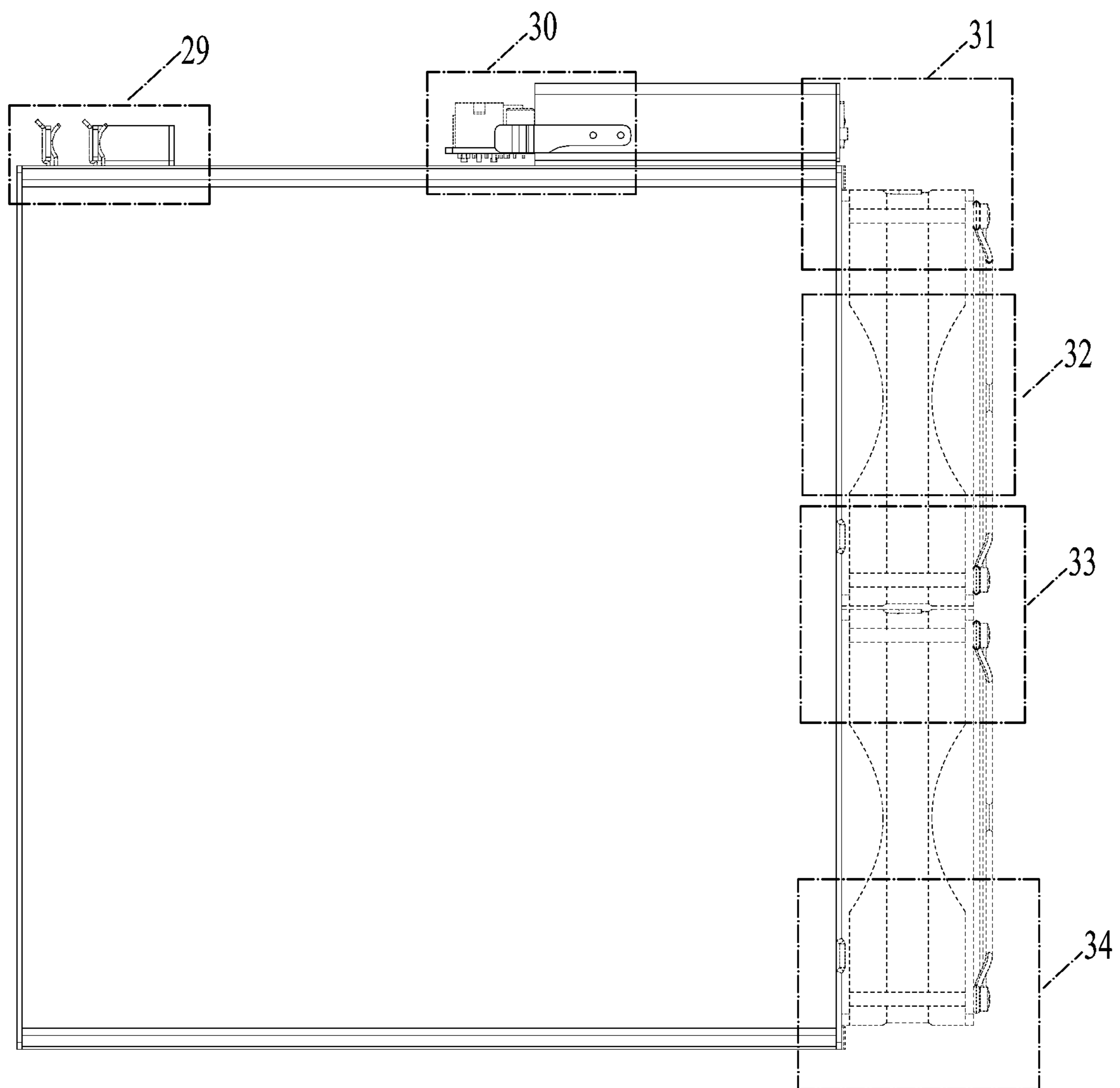

FIG. 3

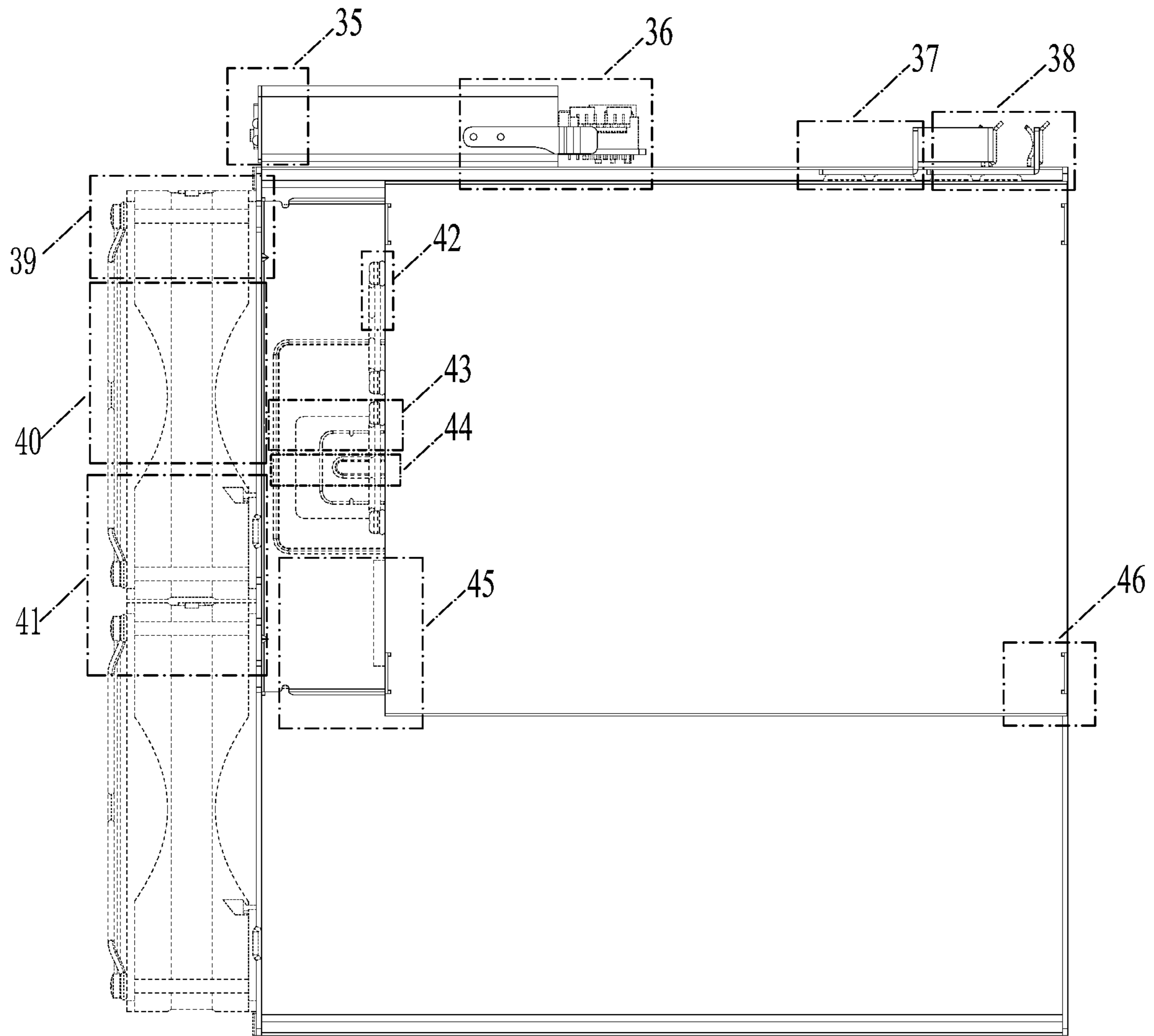

FIG. 4

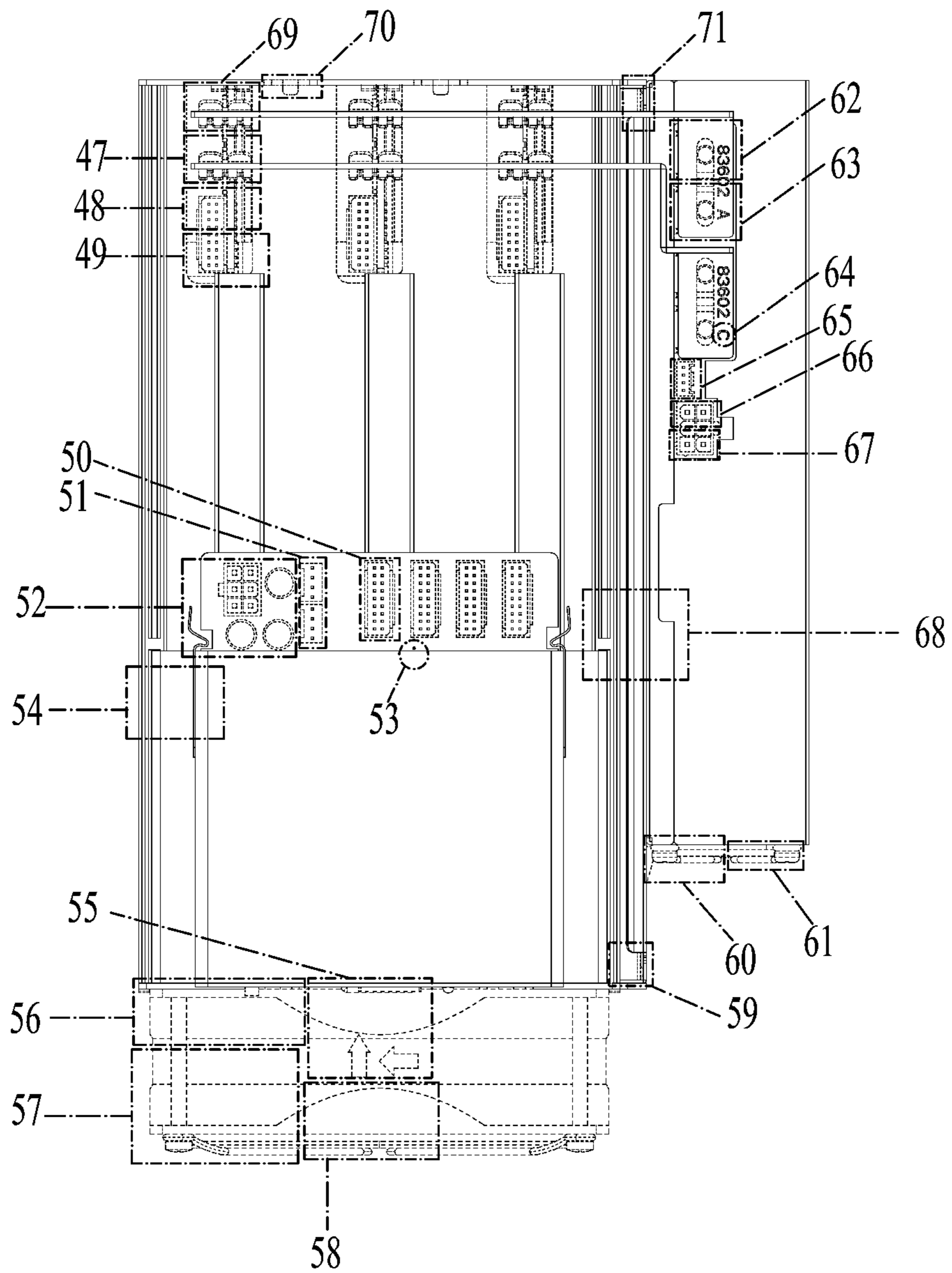

FIG. 5

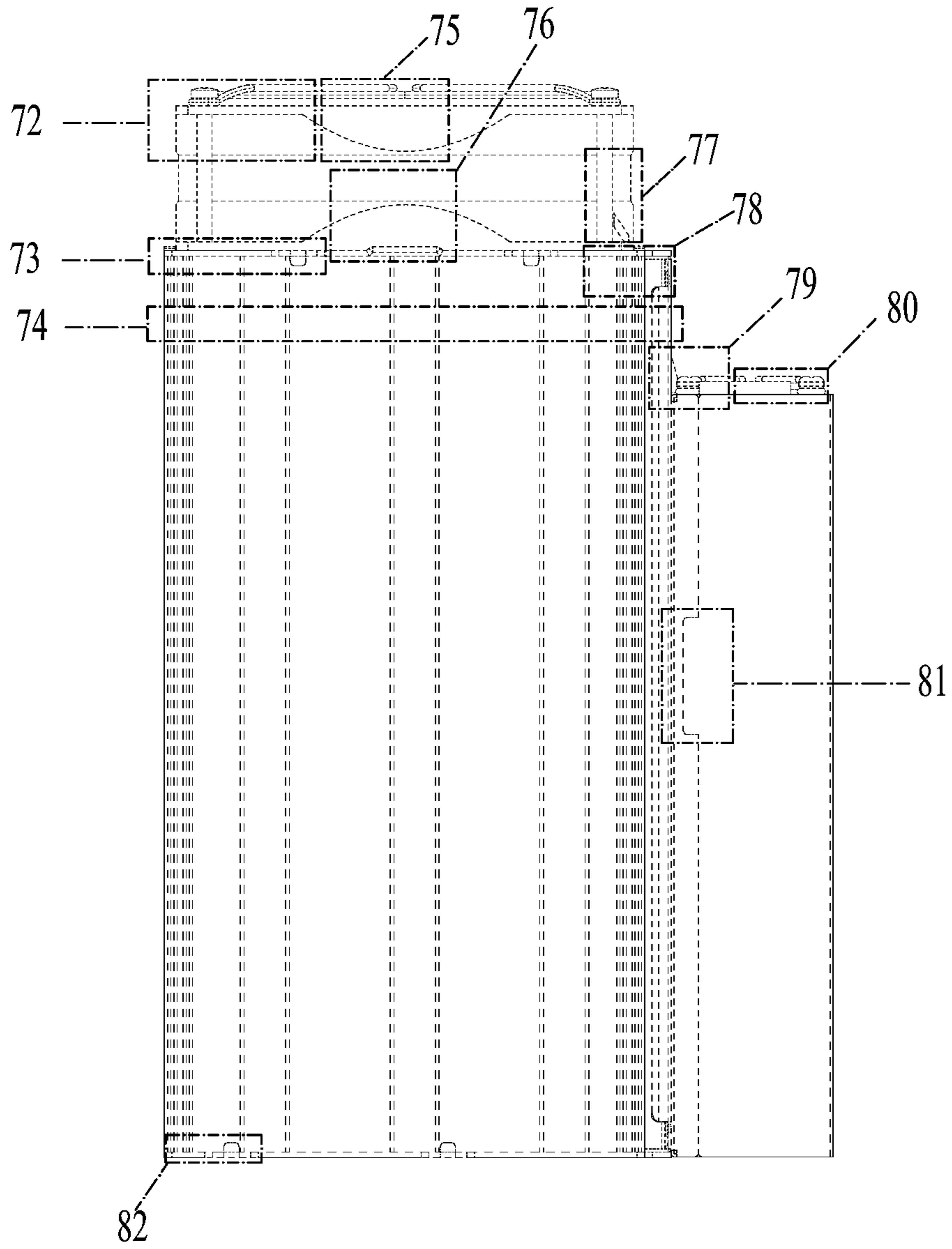

FIG.6

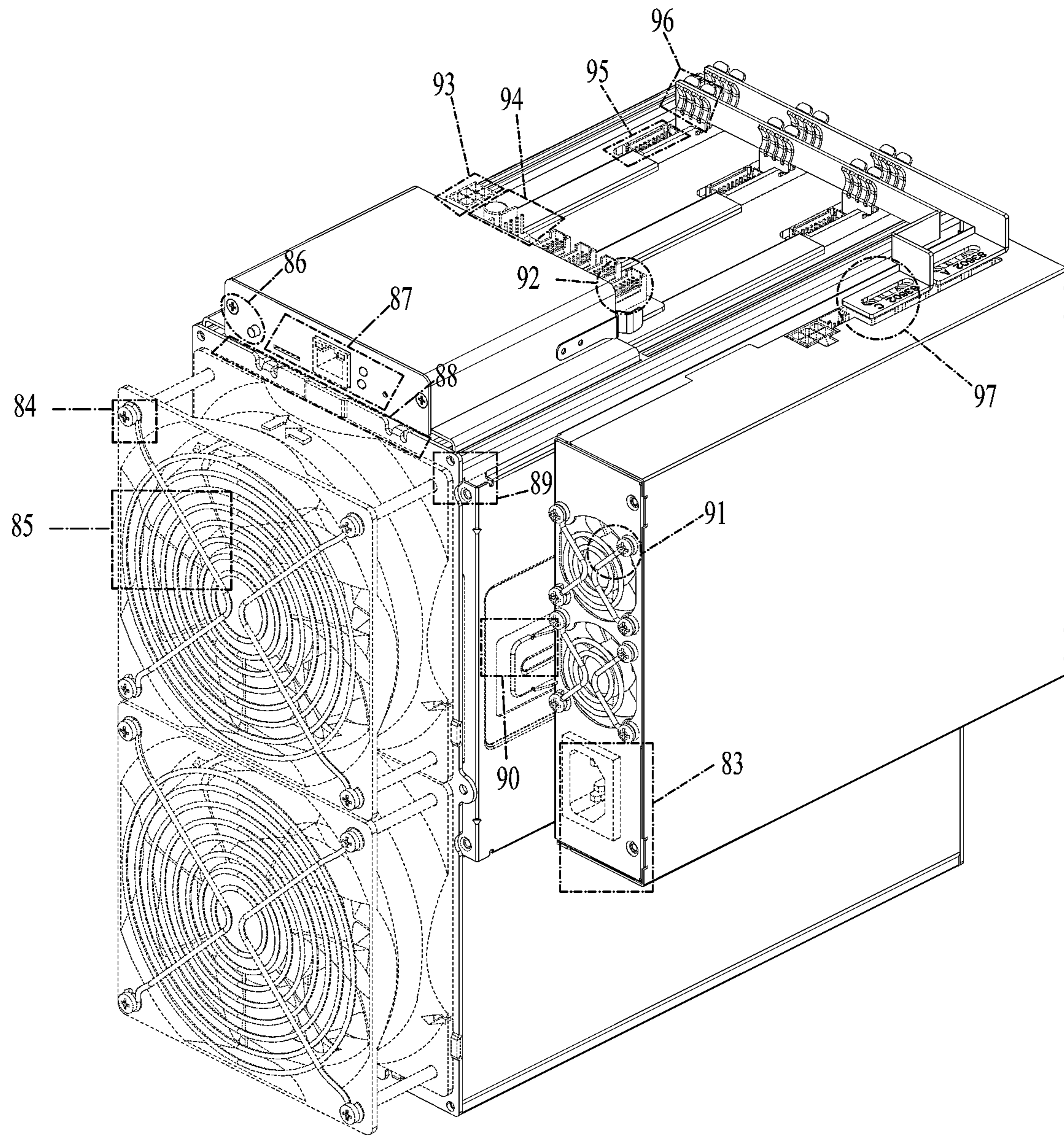

FIG. 7

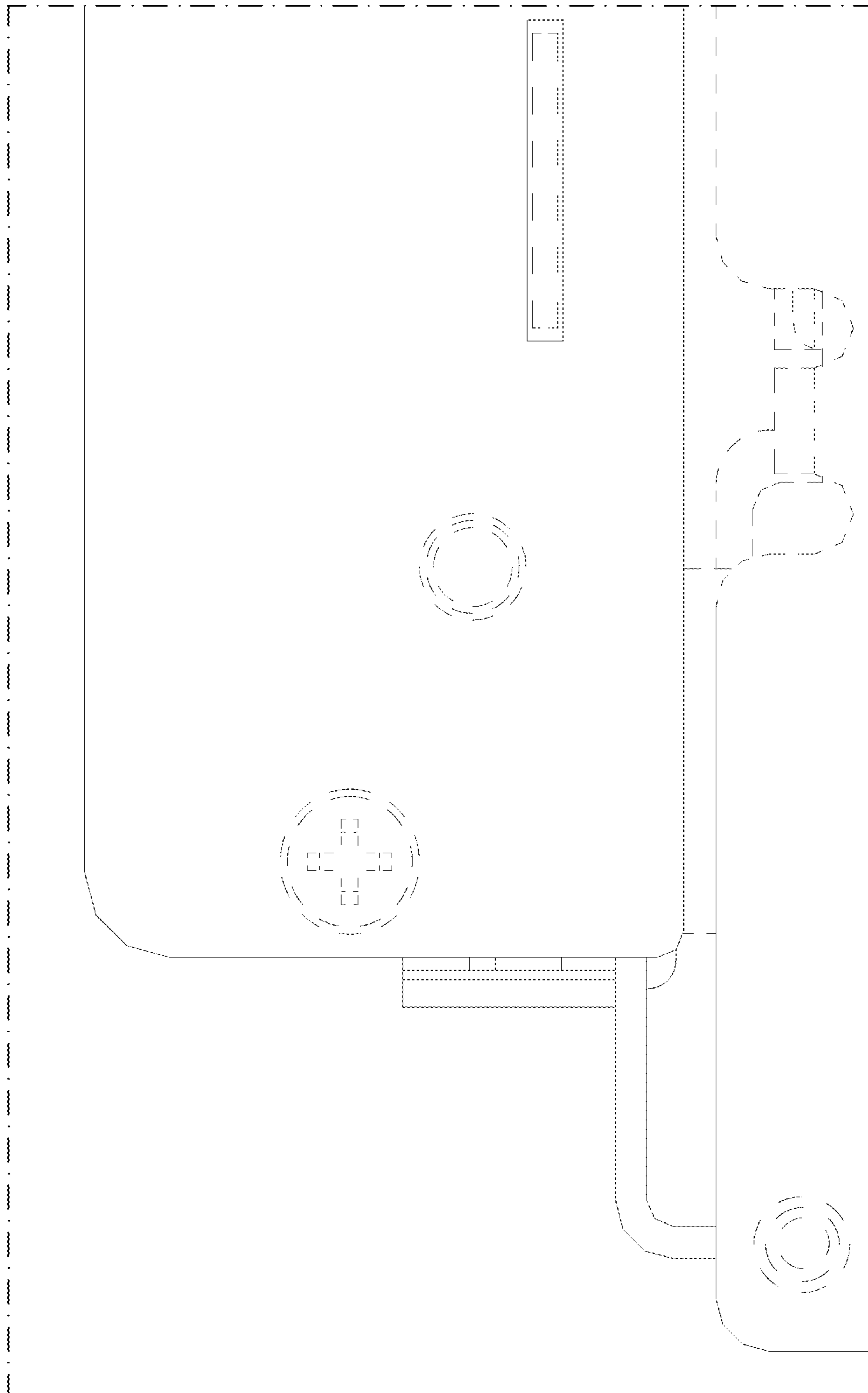

FIG. 8

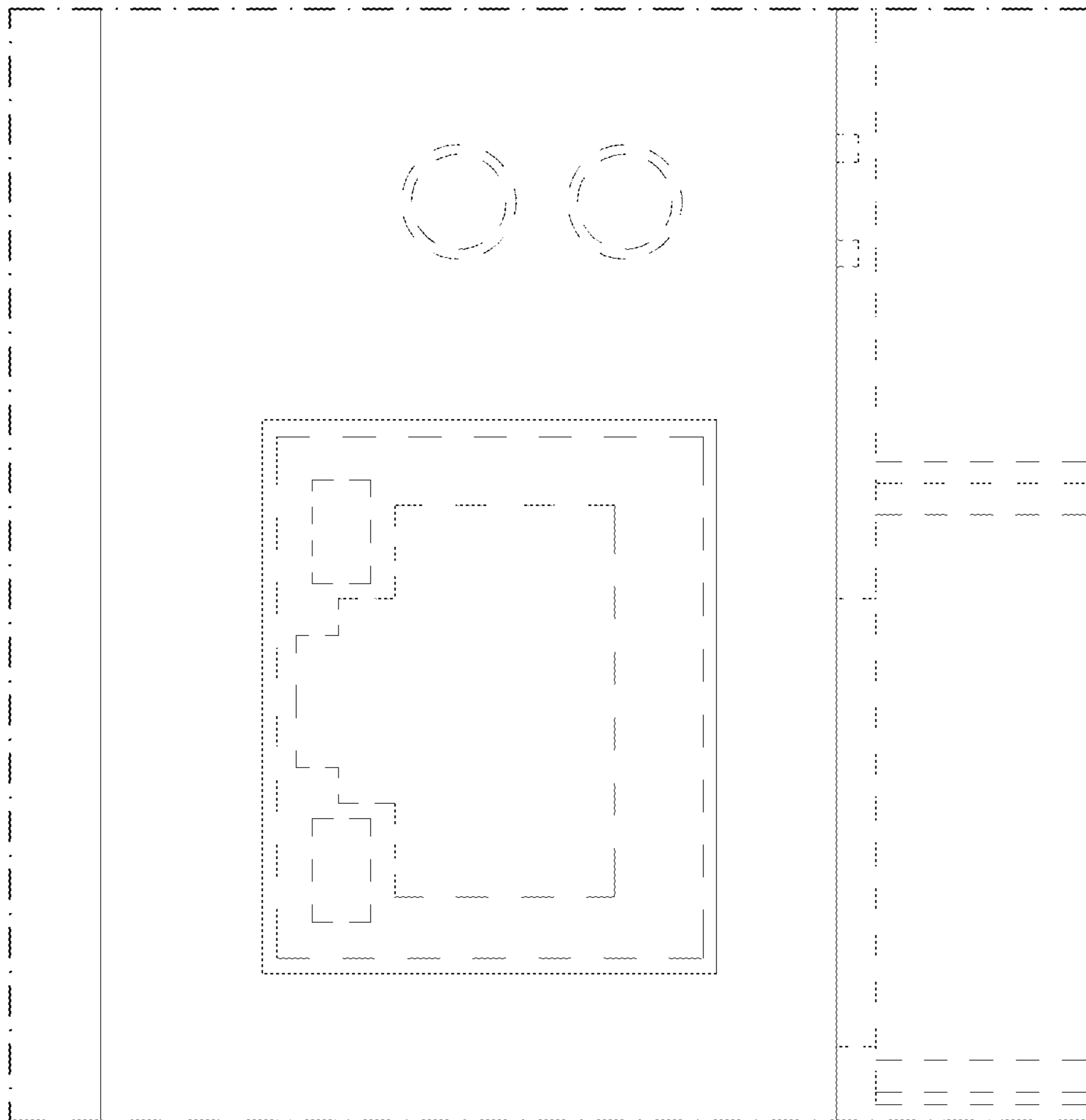

FIG. 9

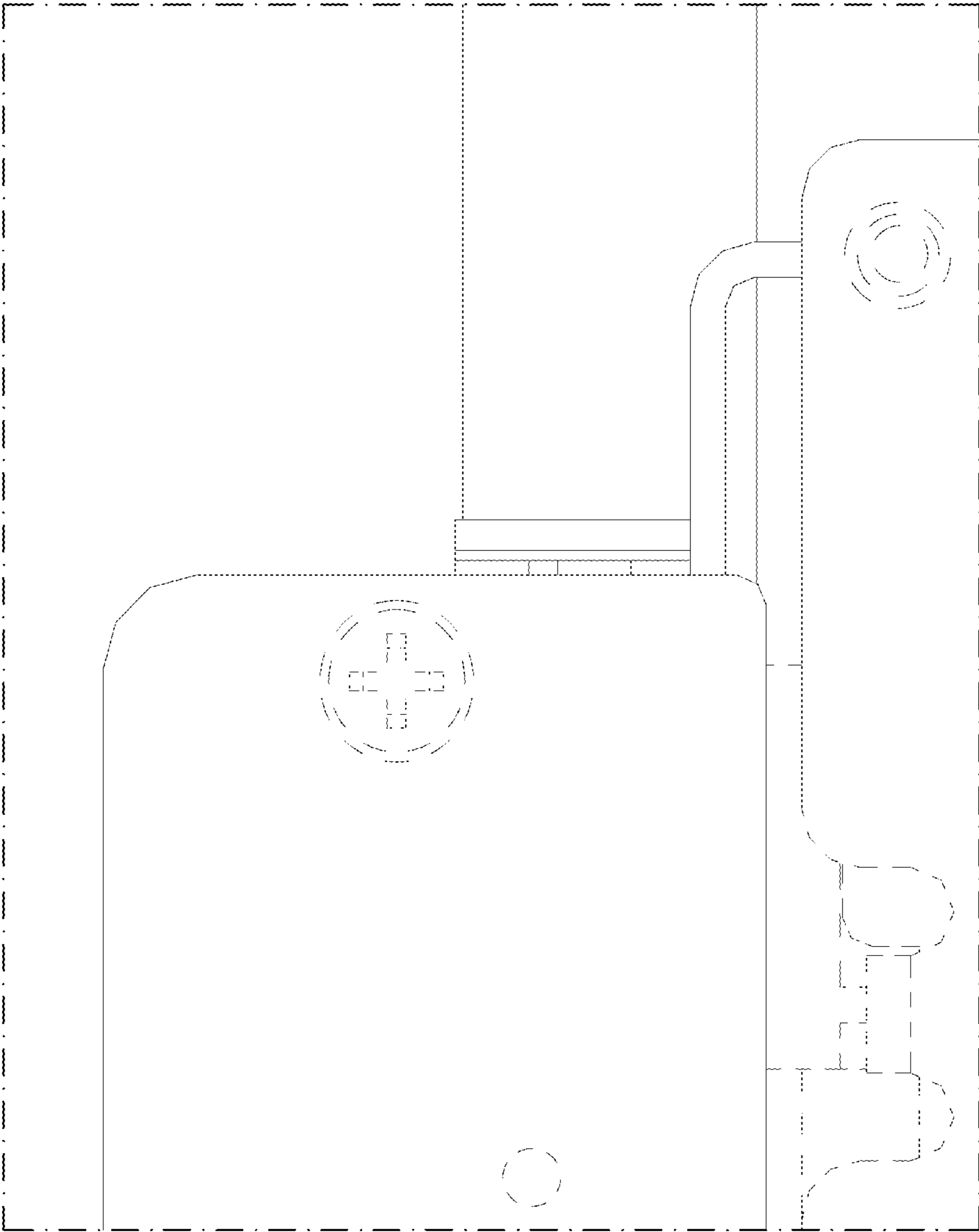

FIG. 10

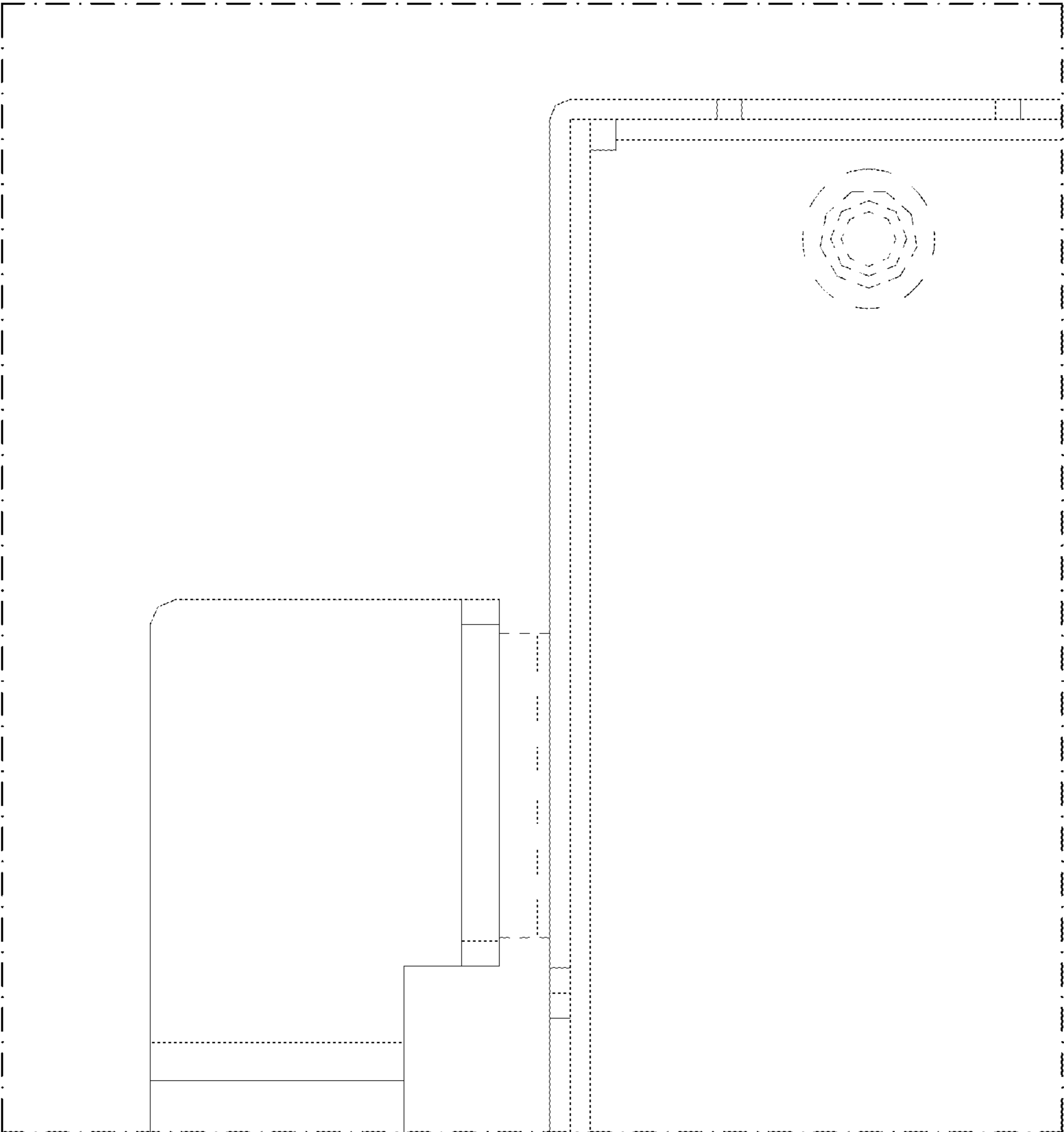

FIG.11

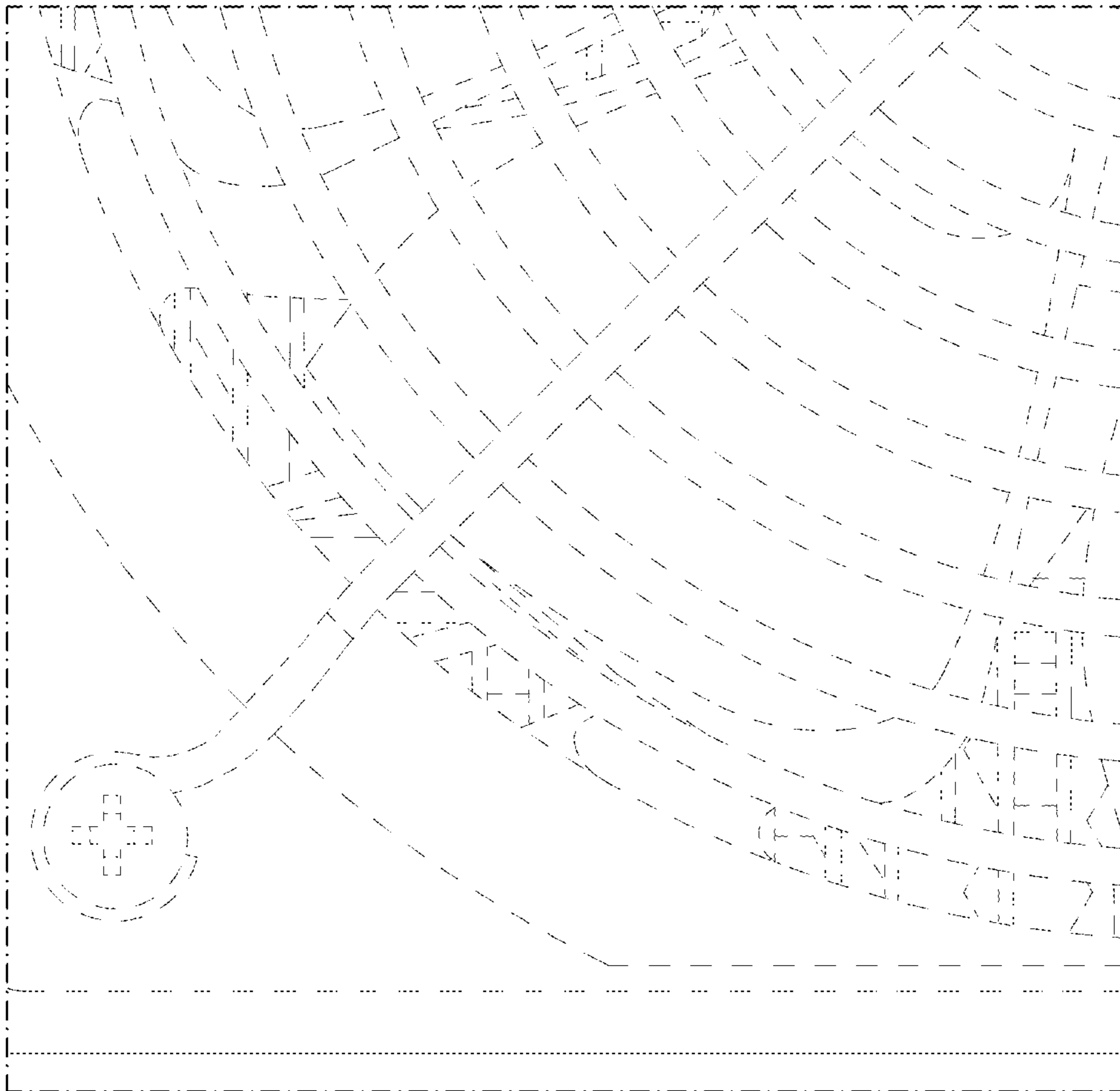

FIG. 12

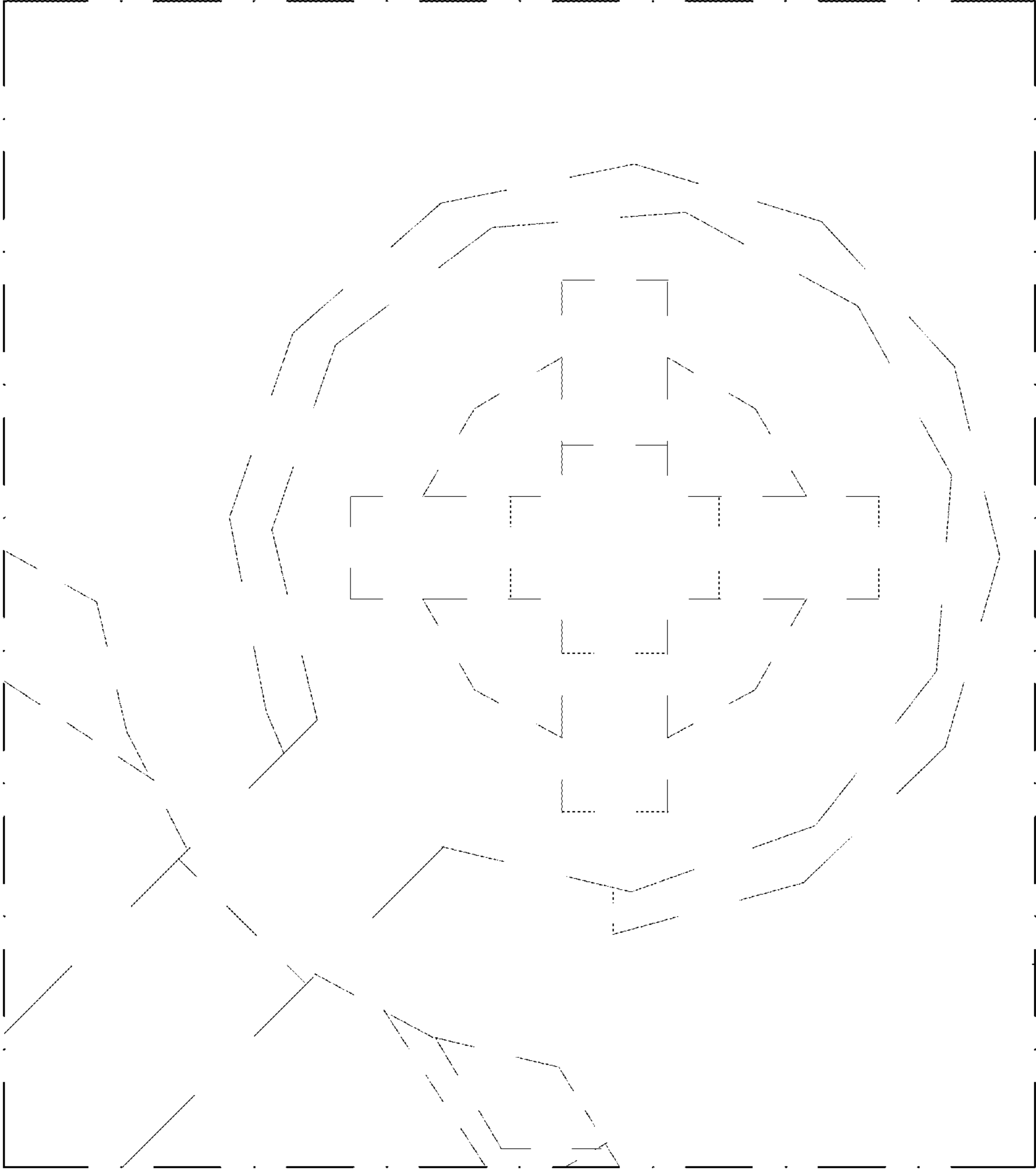

FIG. 13

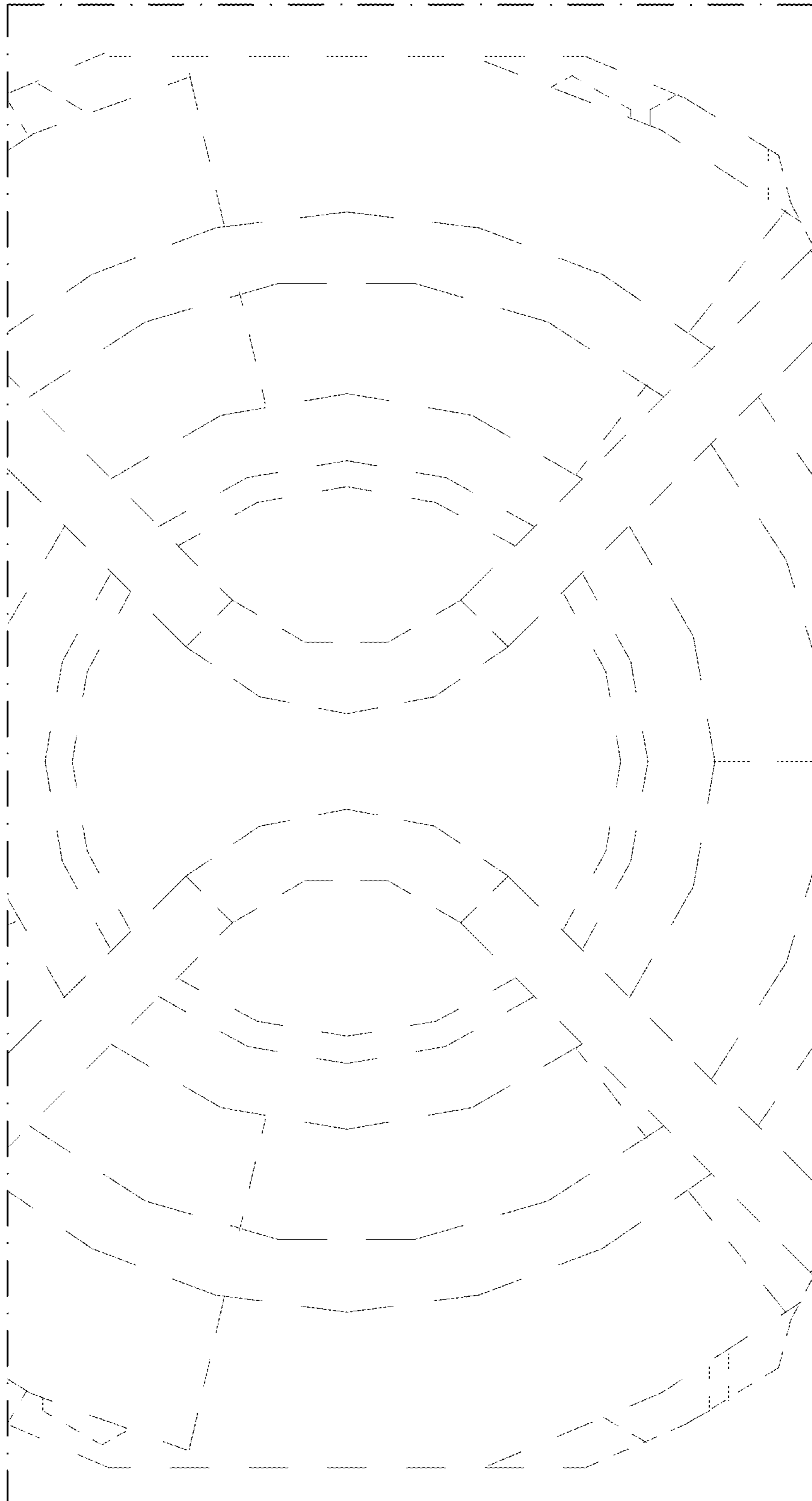

FIG.14

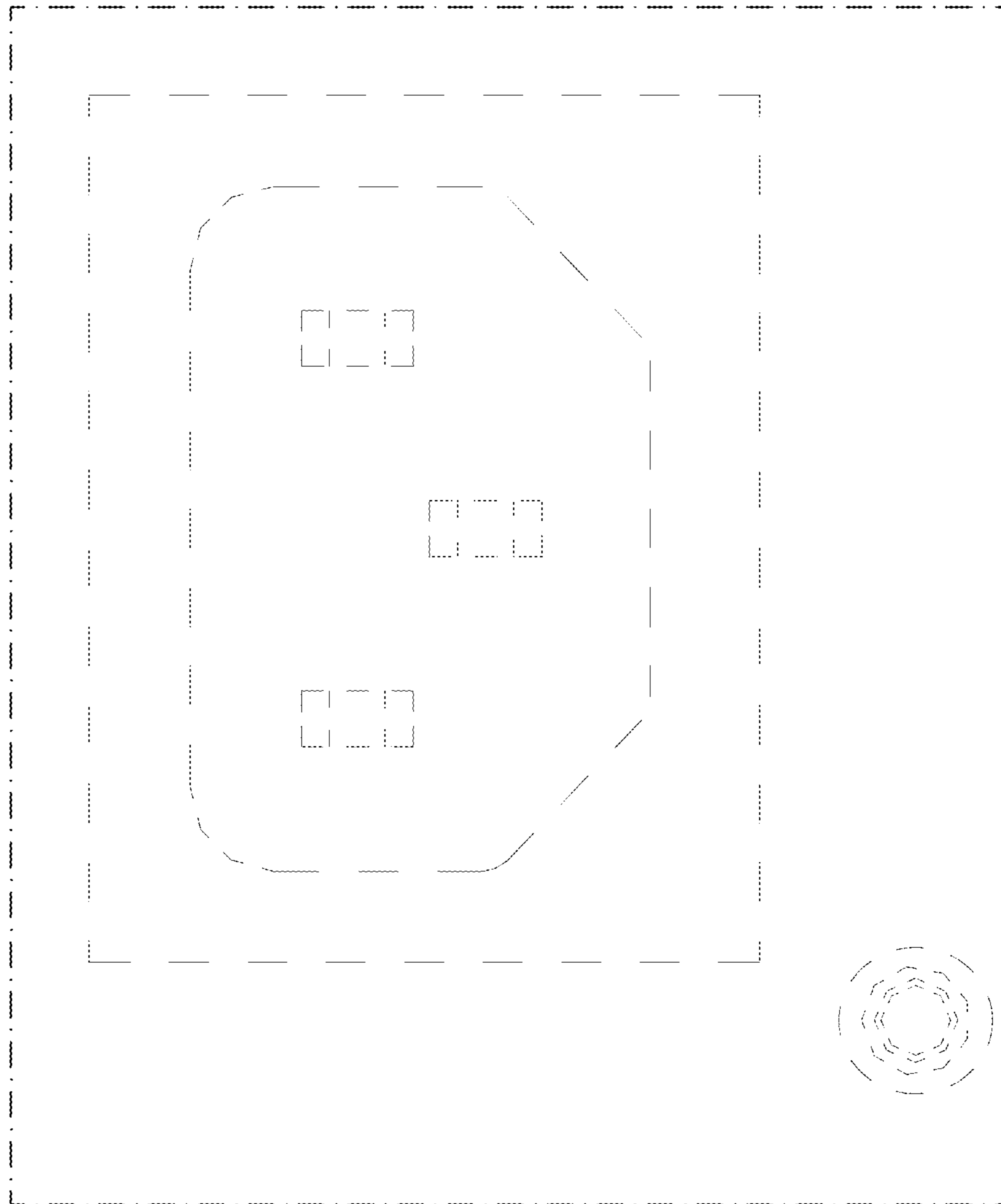

FIG. 15

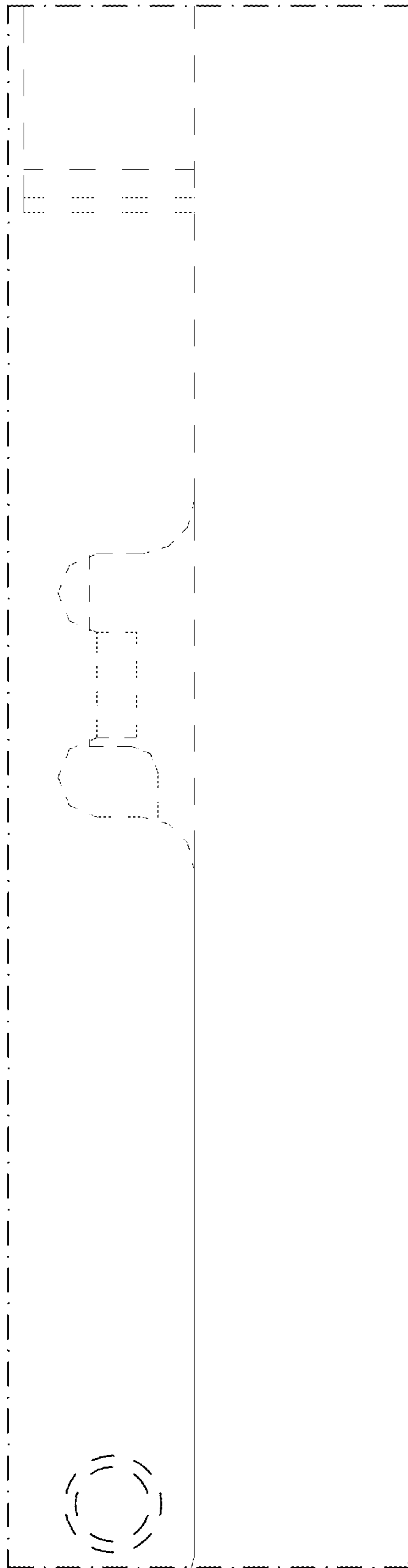

FIG.16

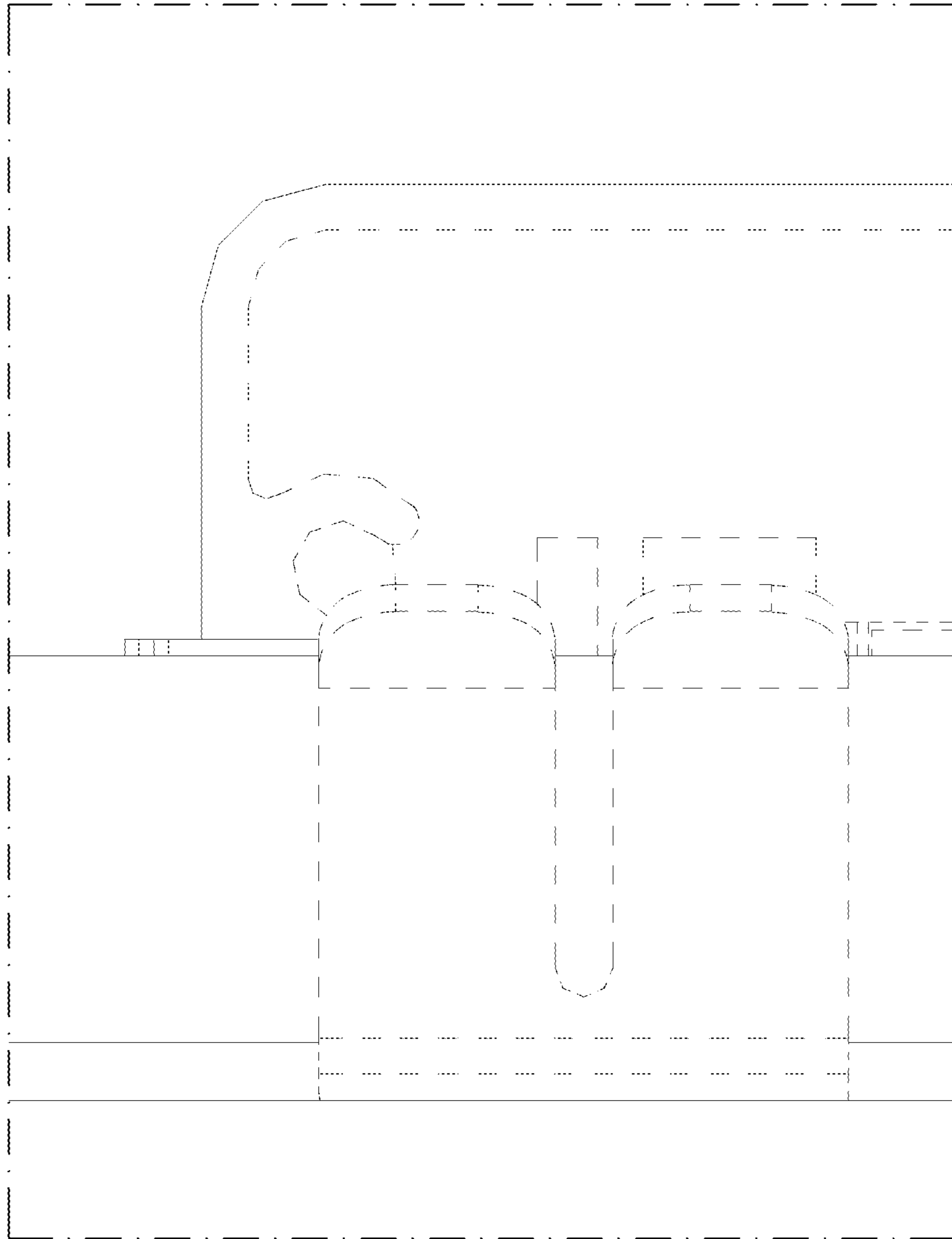

FIG. 17

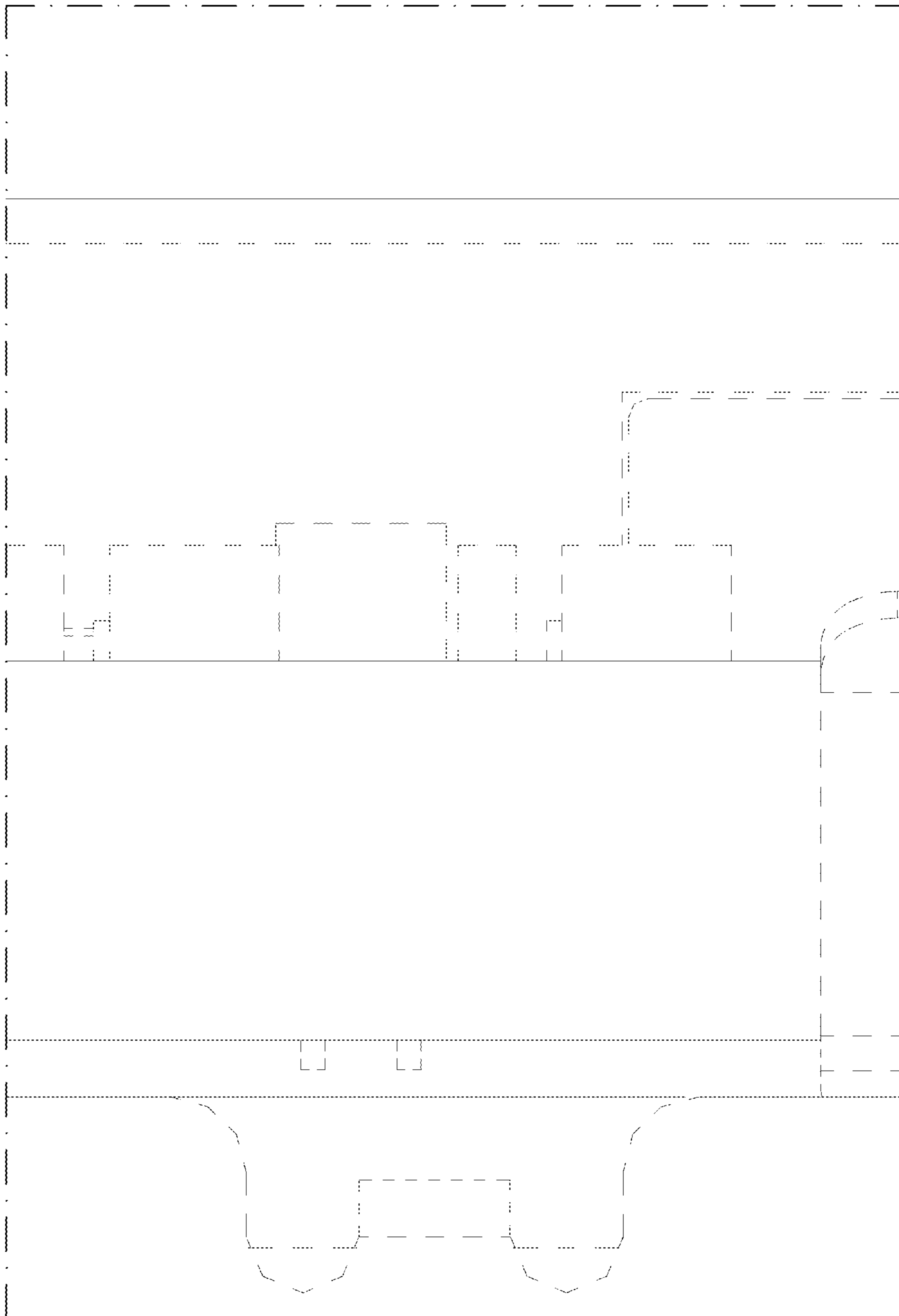

FIG. 18

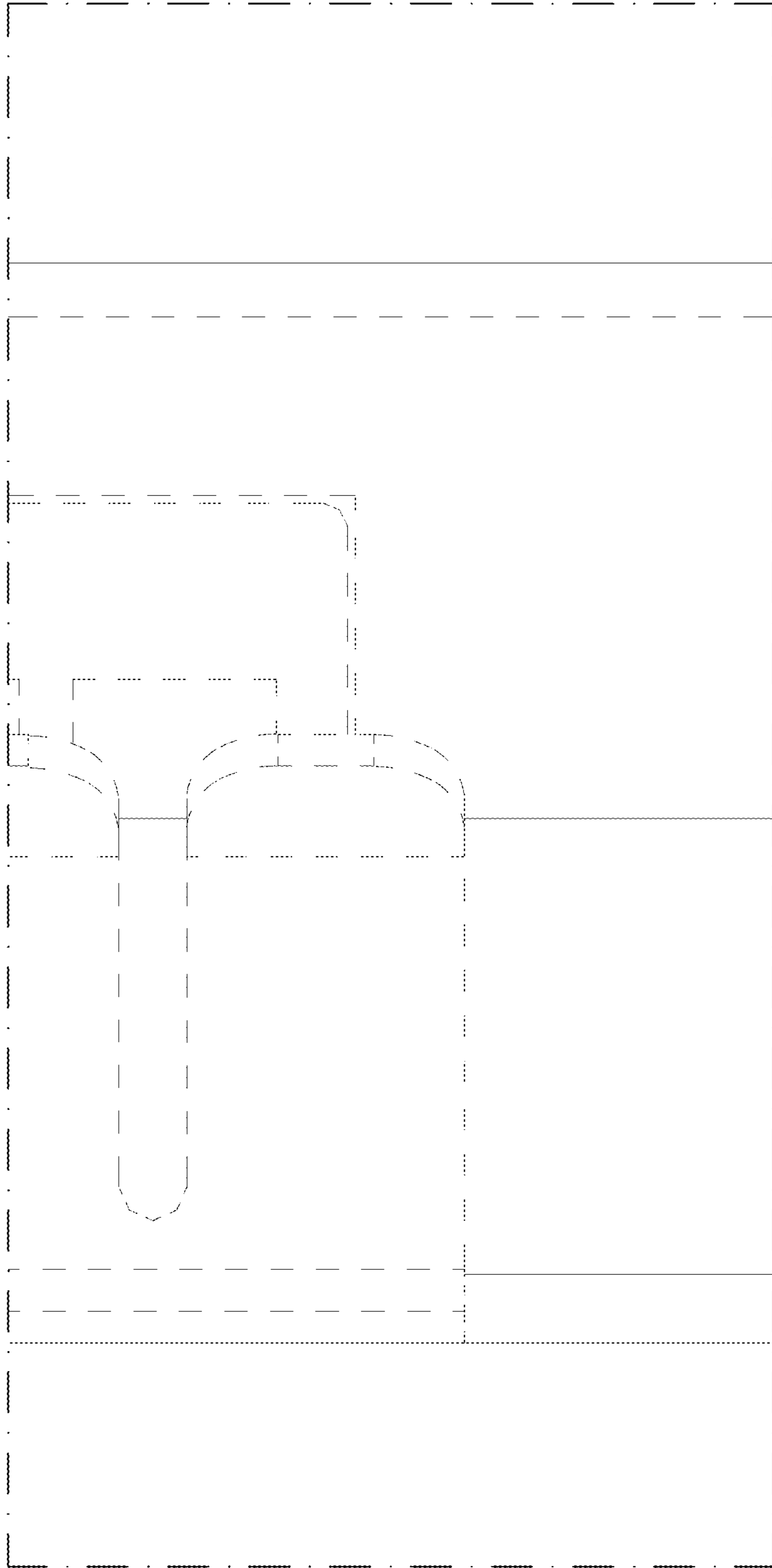

FIG. 19

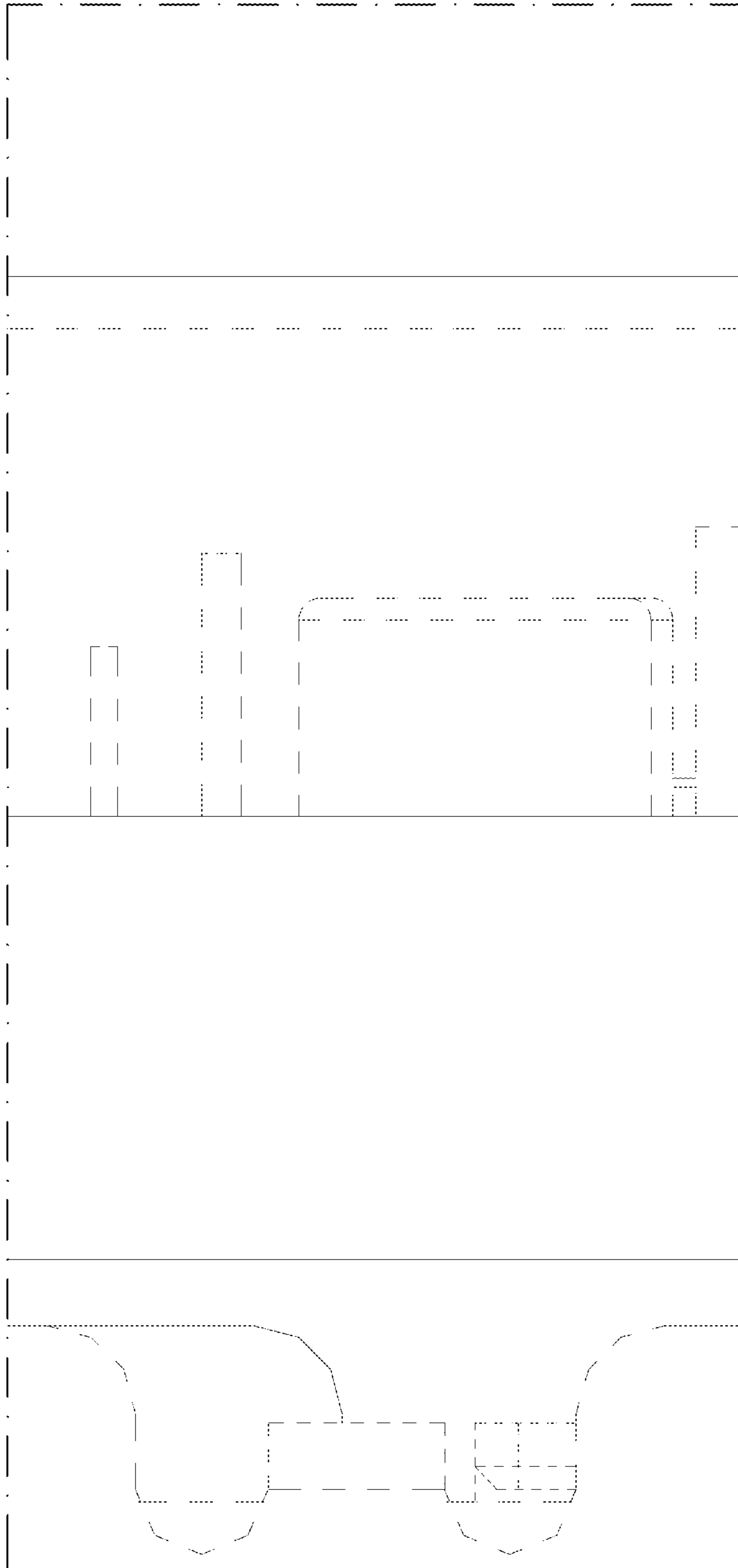

FIG. 20

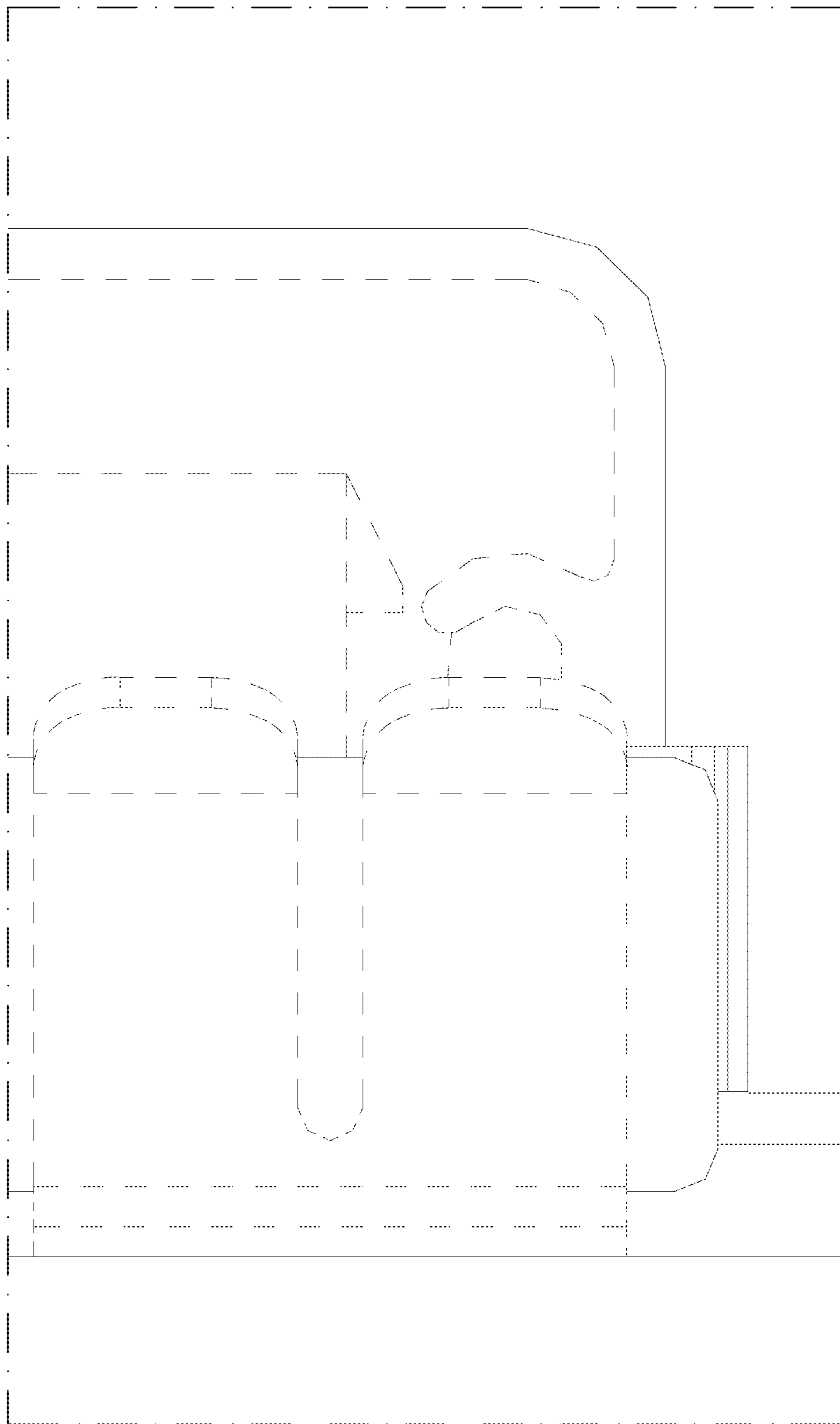

FIG. 21

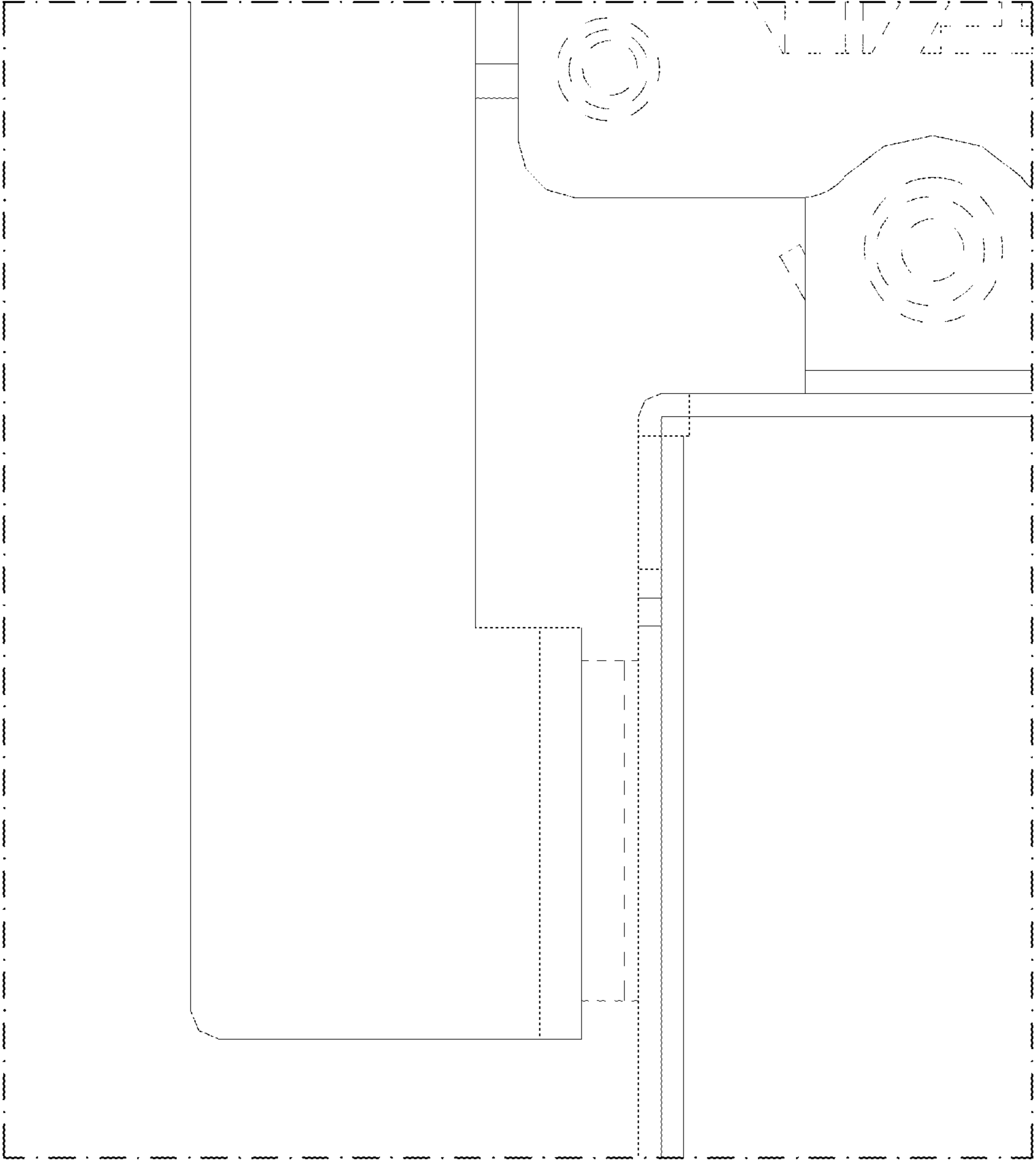

FIG.22

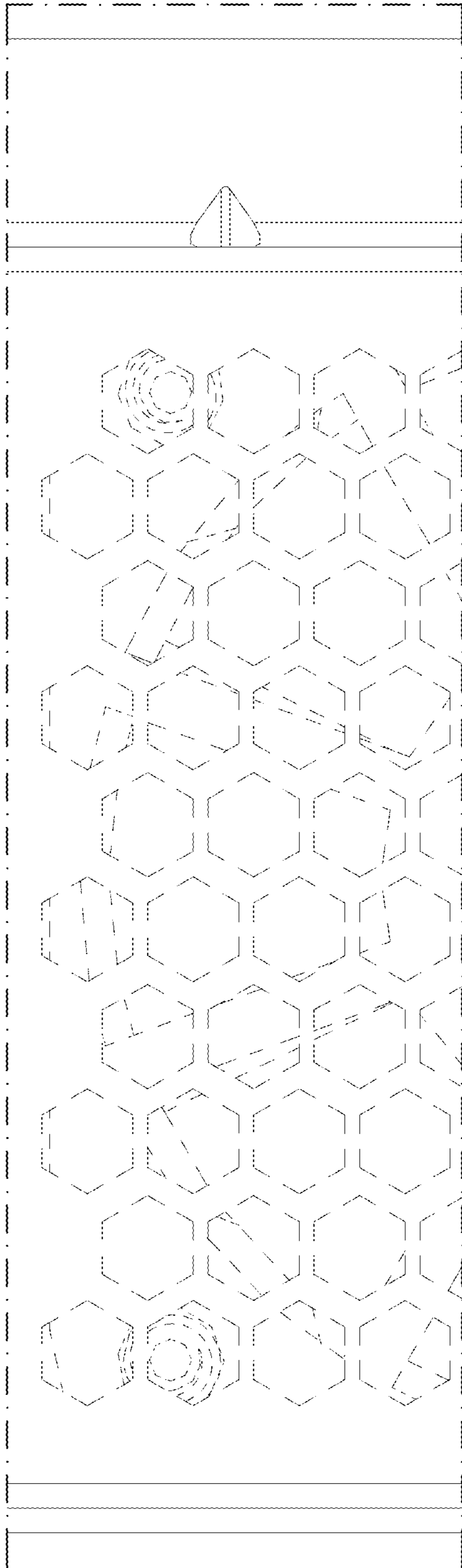

FIG.23

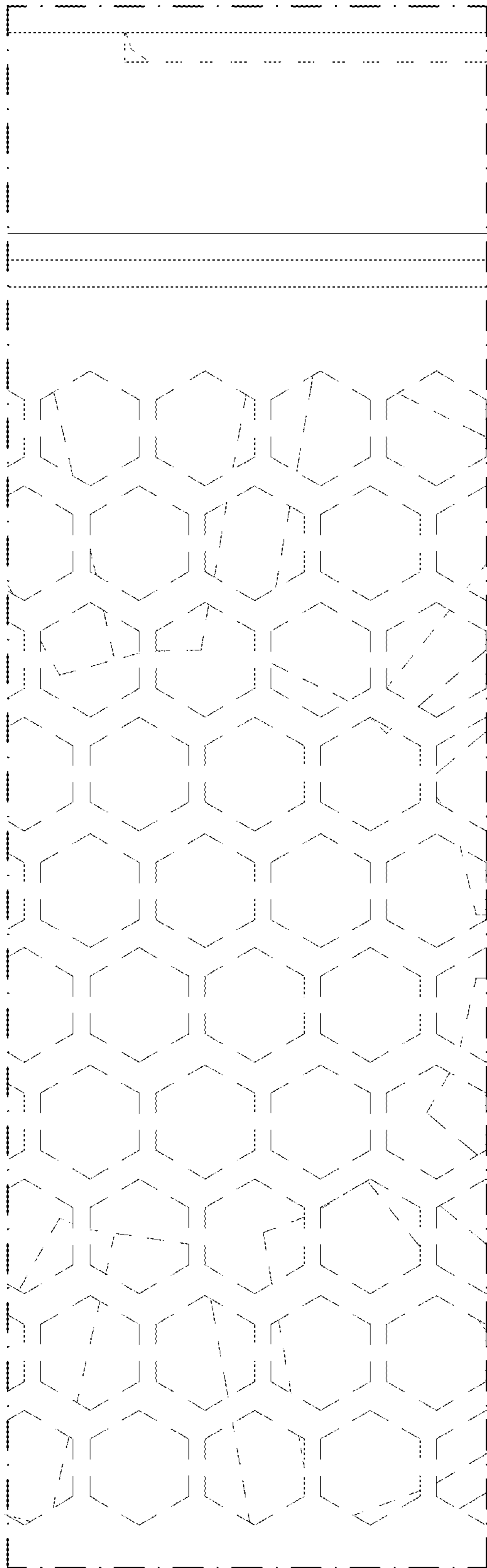

FIG.24

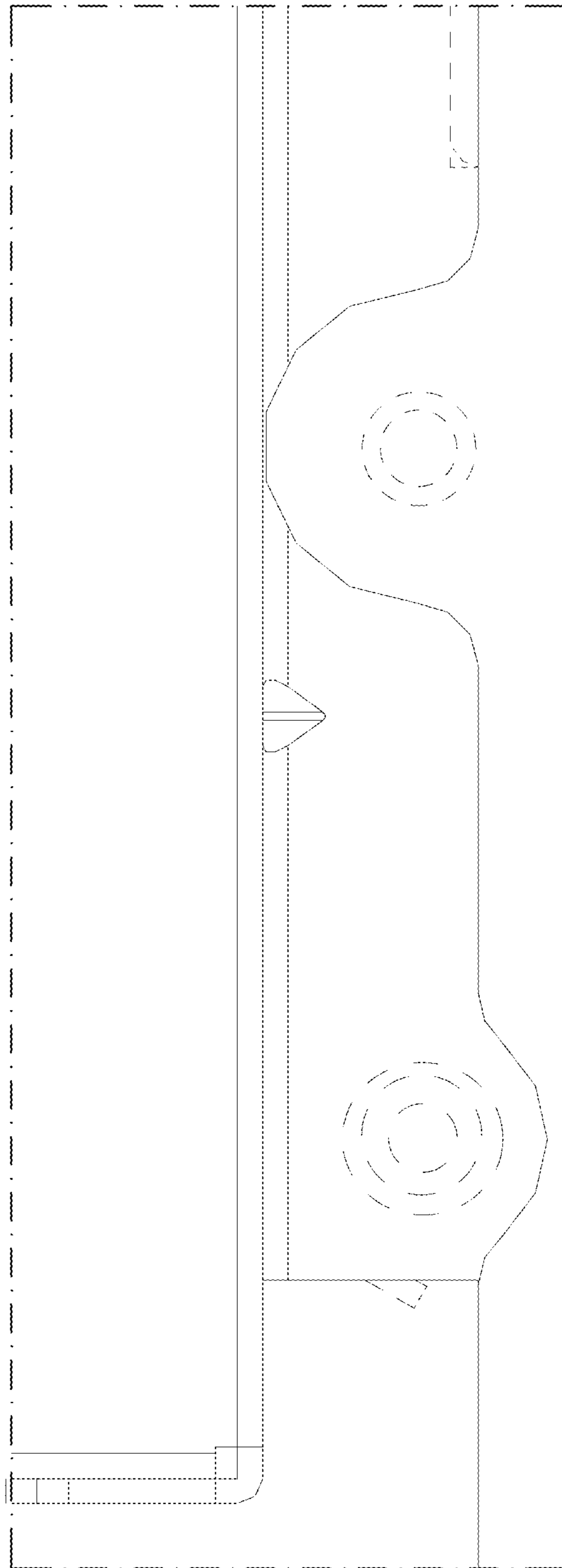

FIG. 25

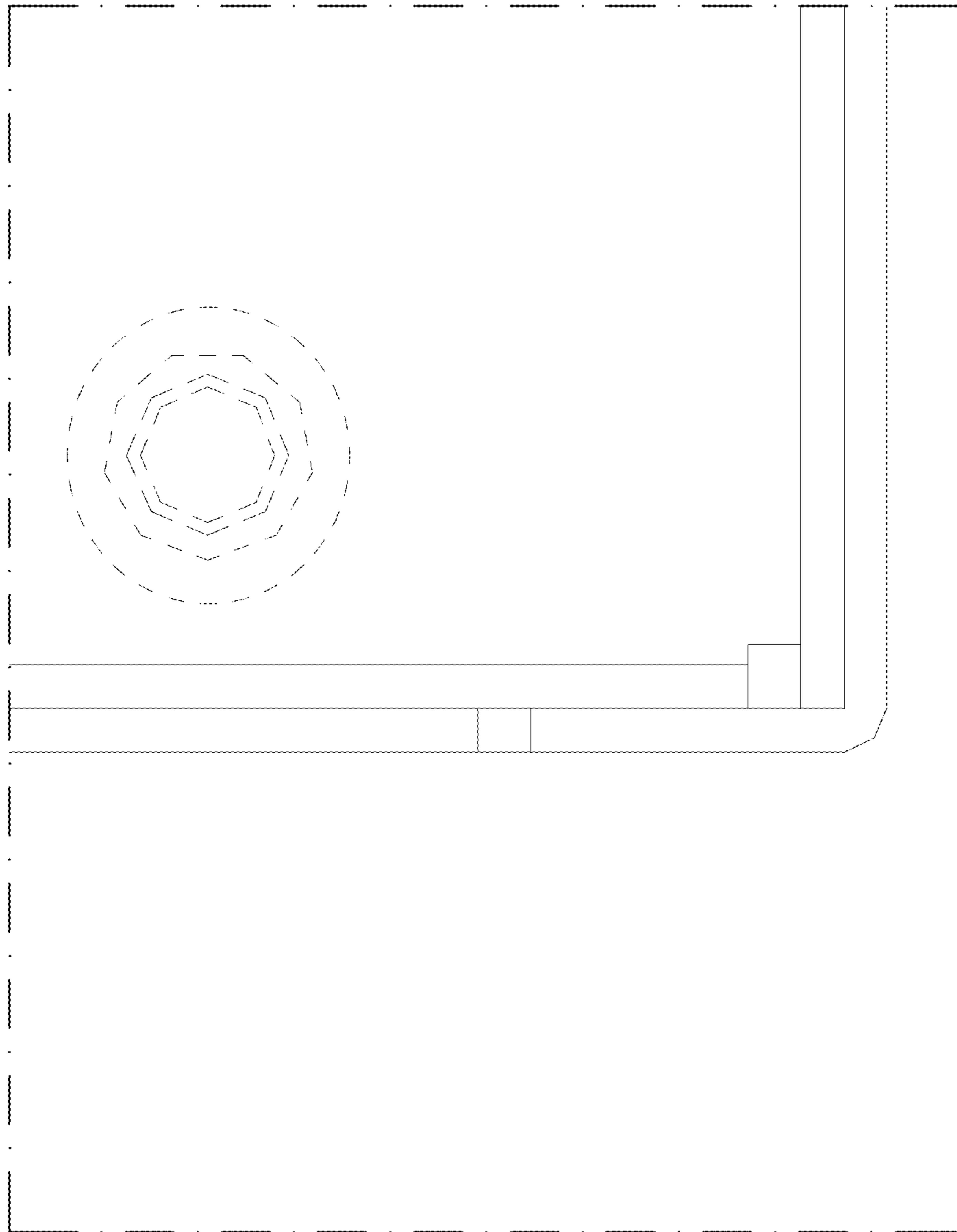

FIG. 26

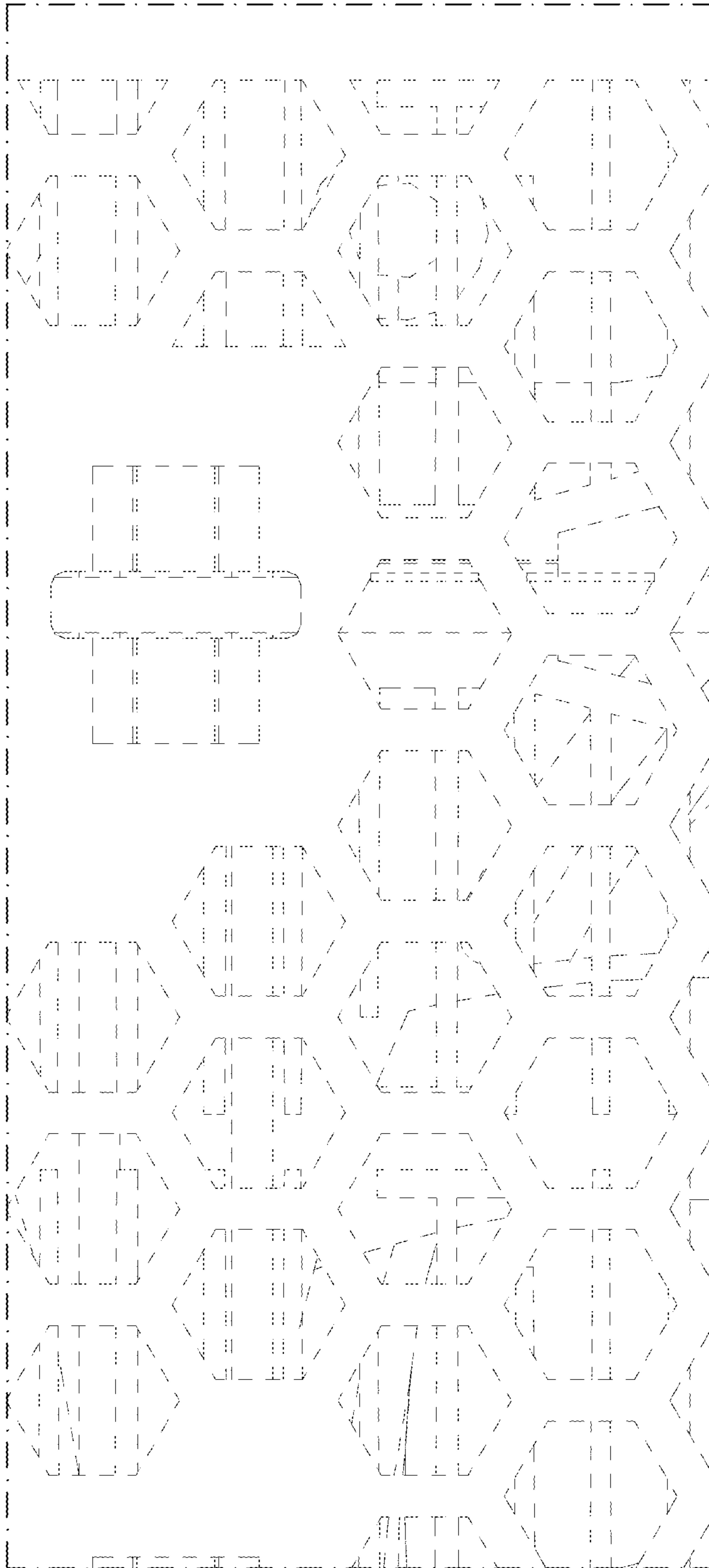

FIG. 27

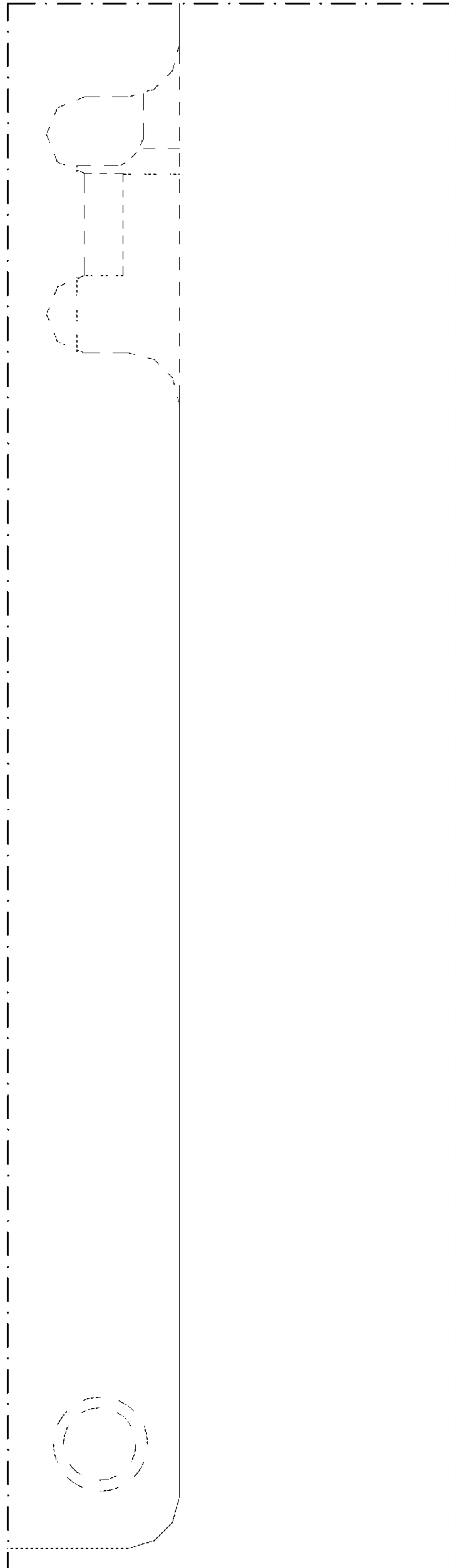

FIG. 28

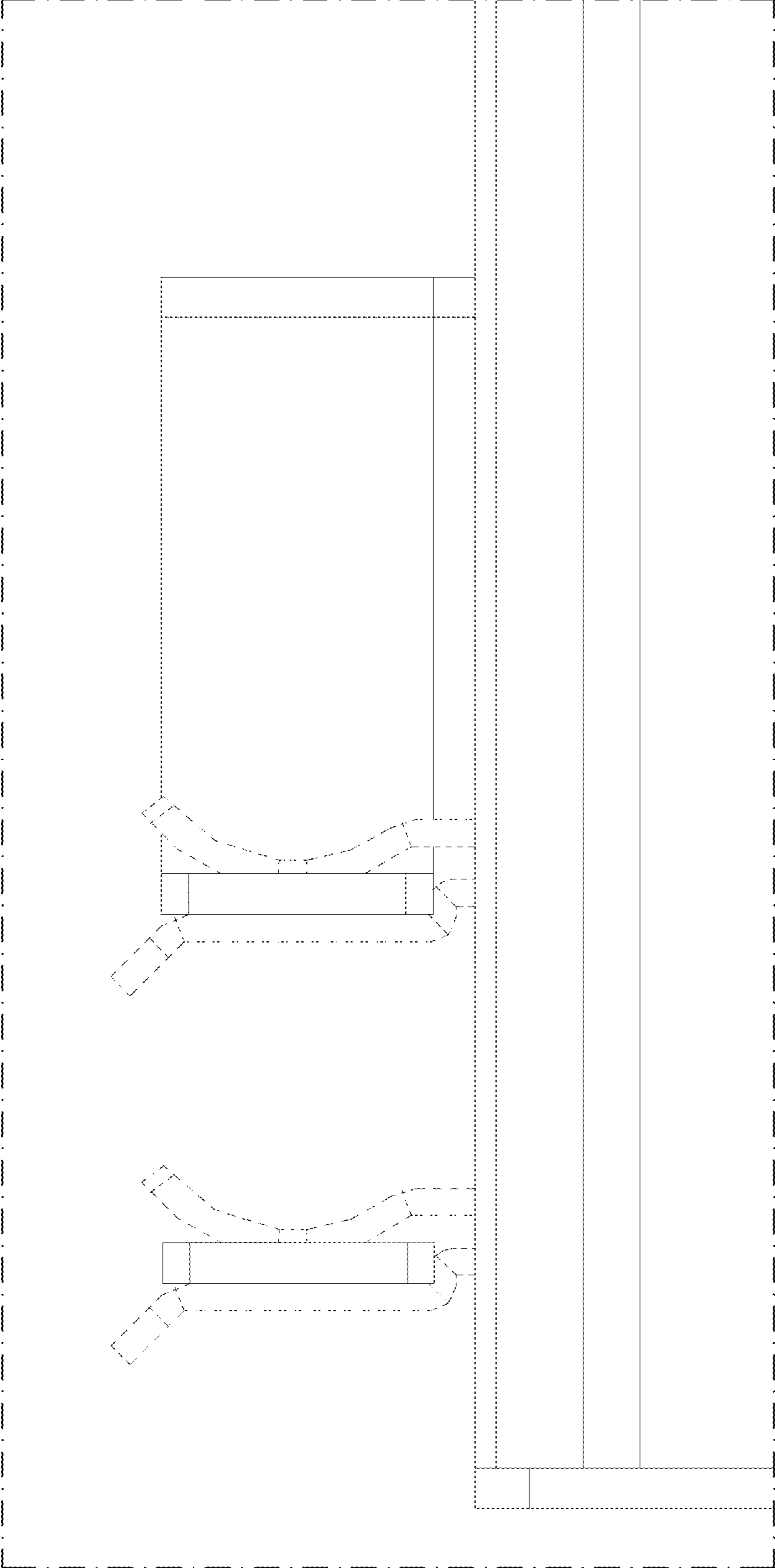

FIG. 29

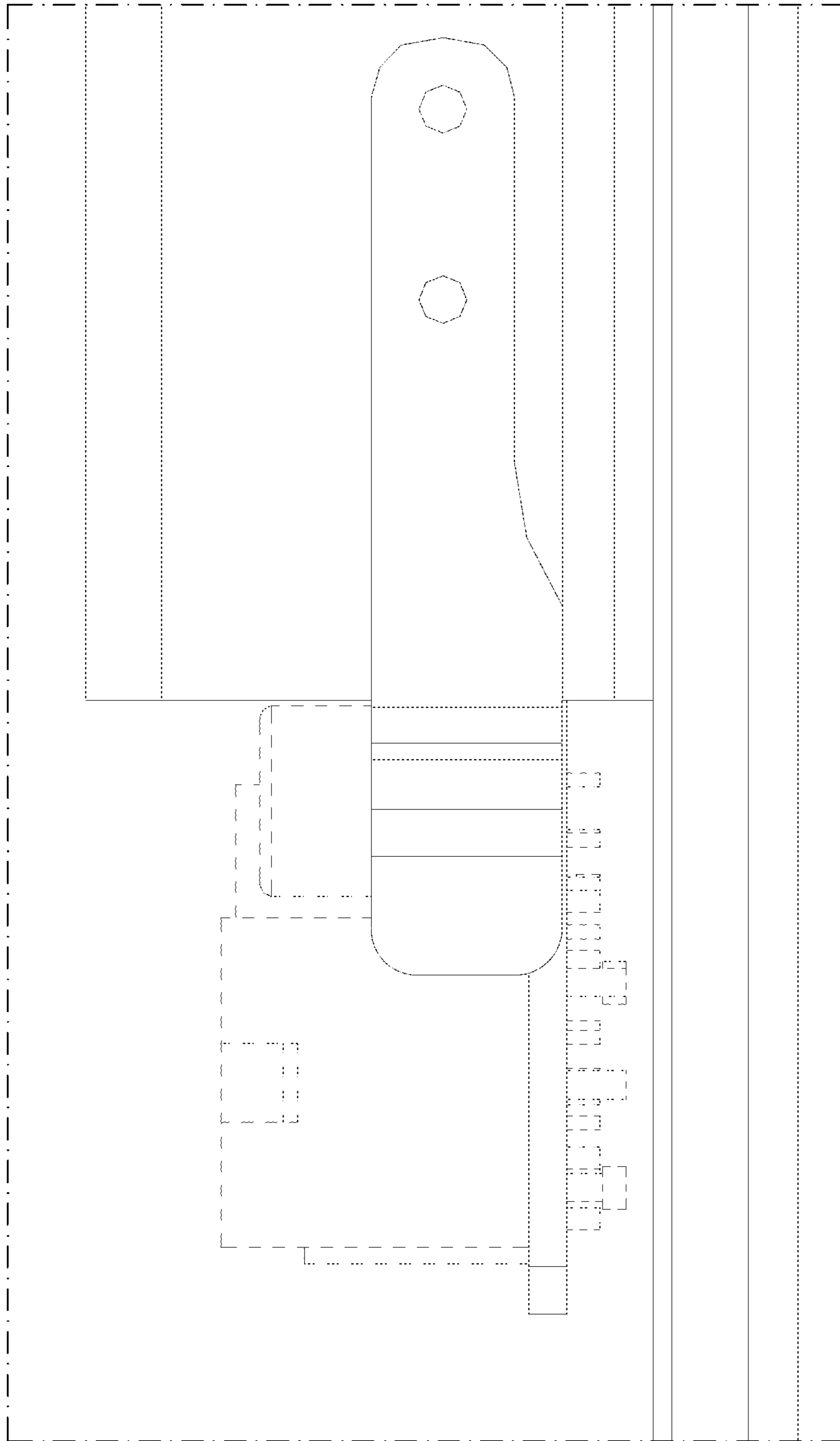

FIG.30

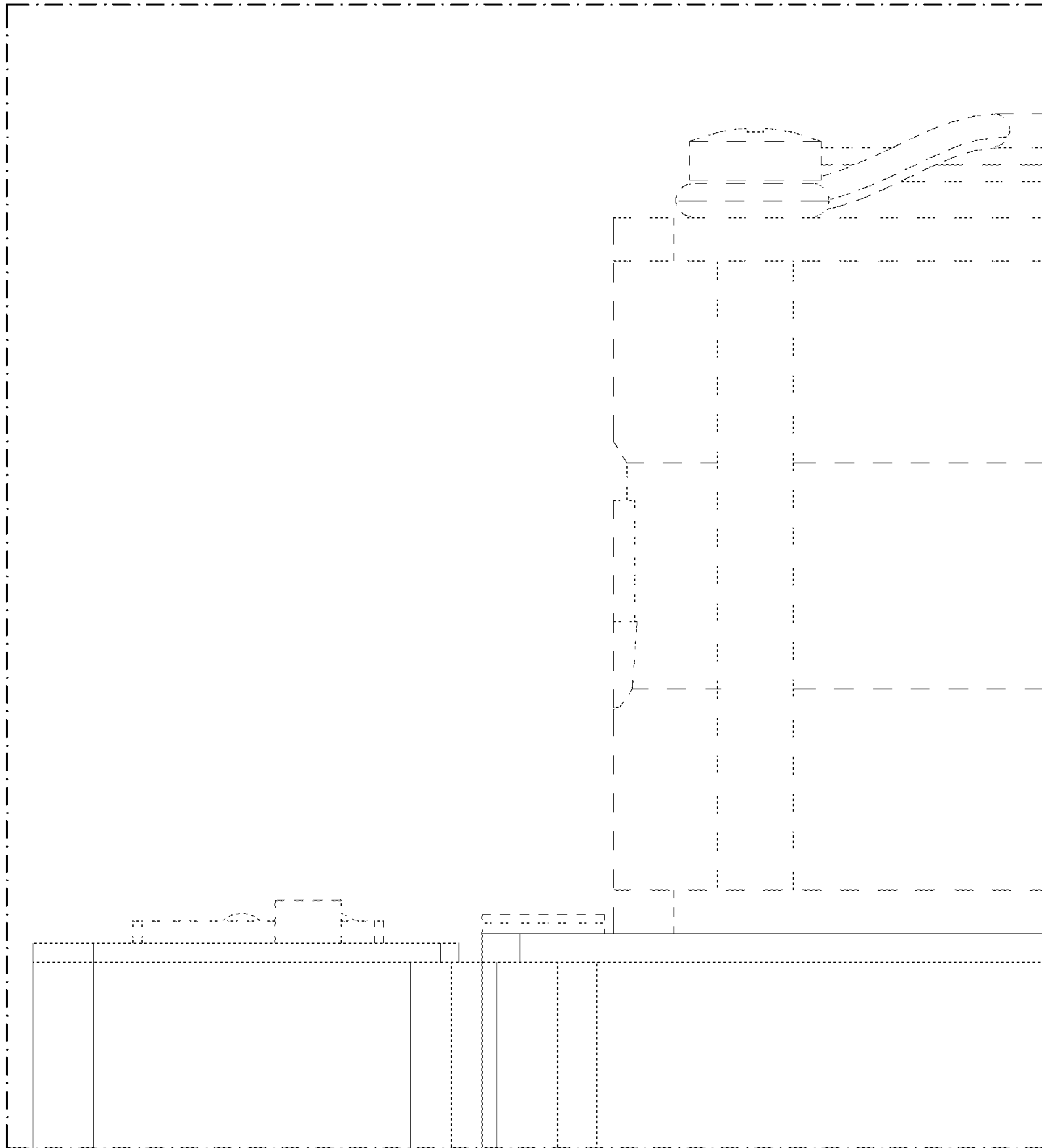

FIG. 31

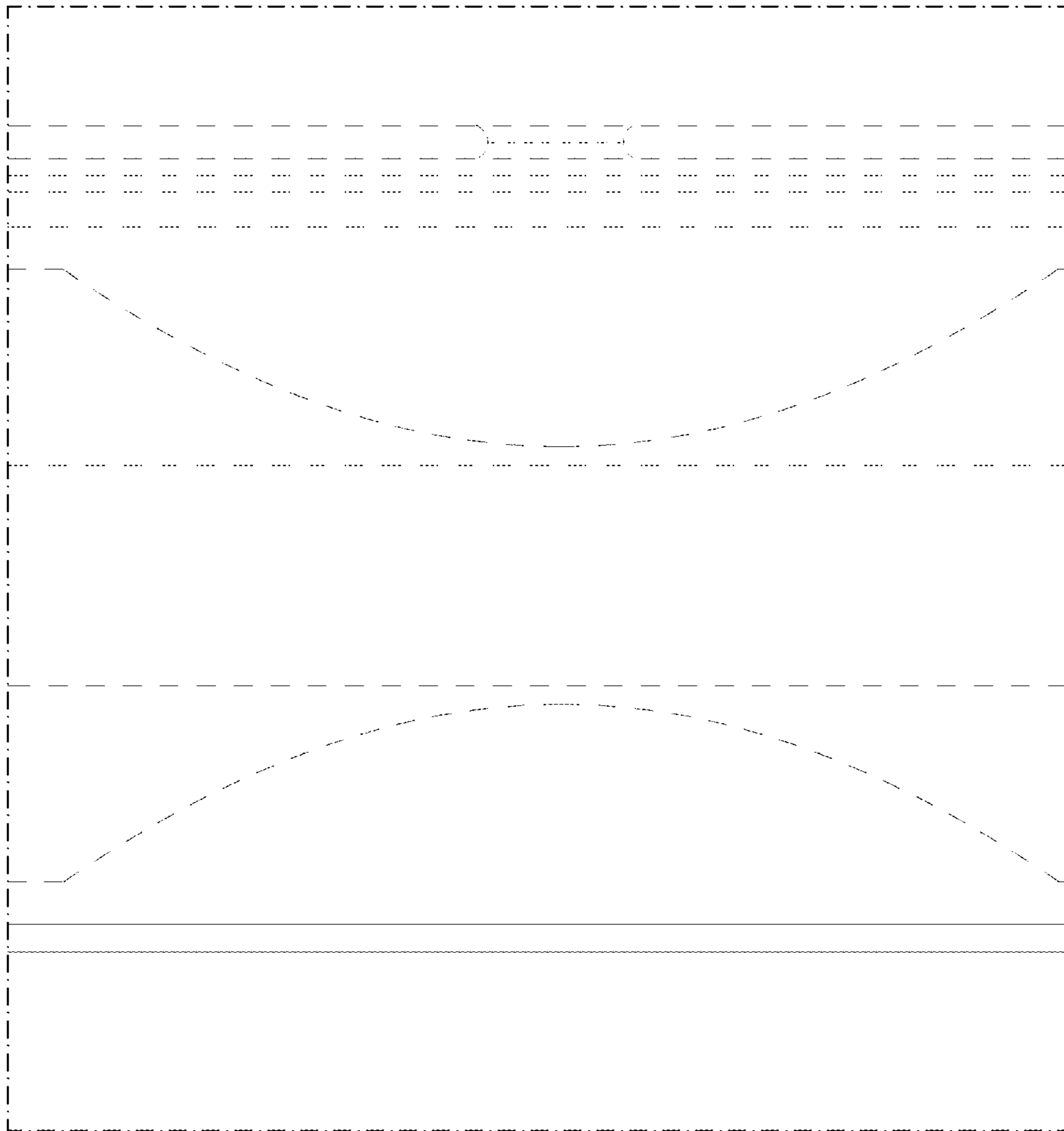

FIG.32

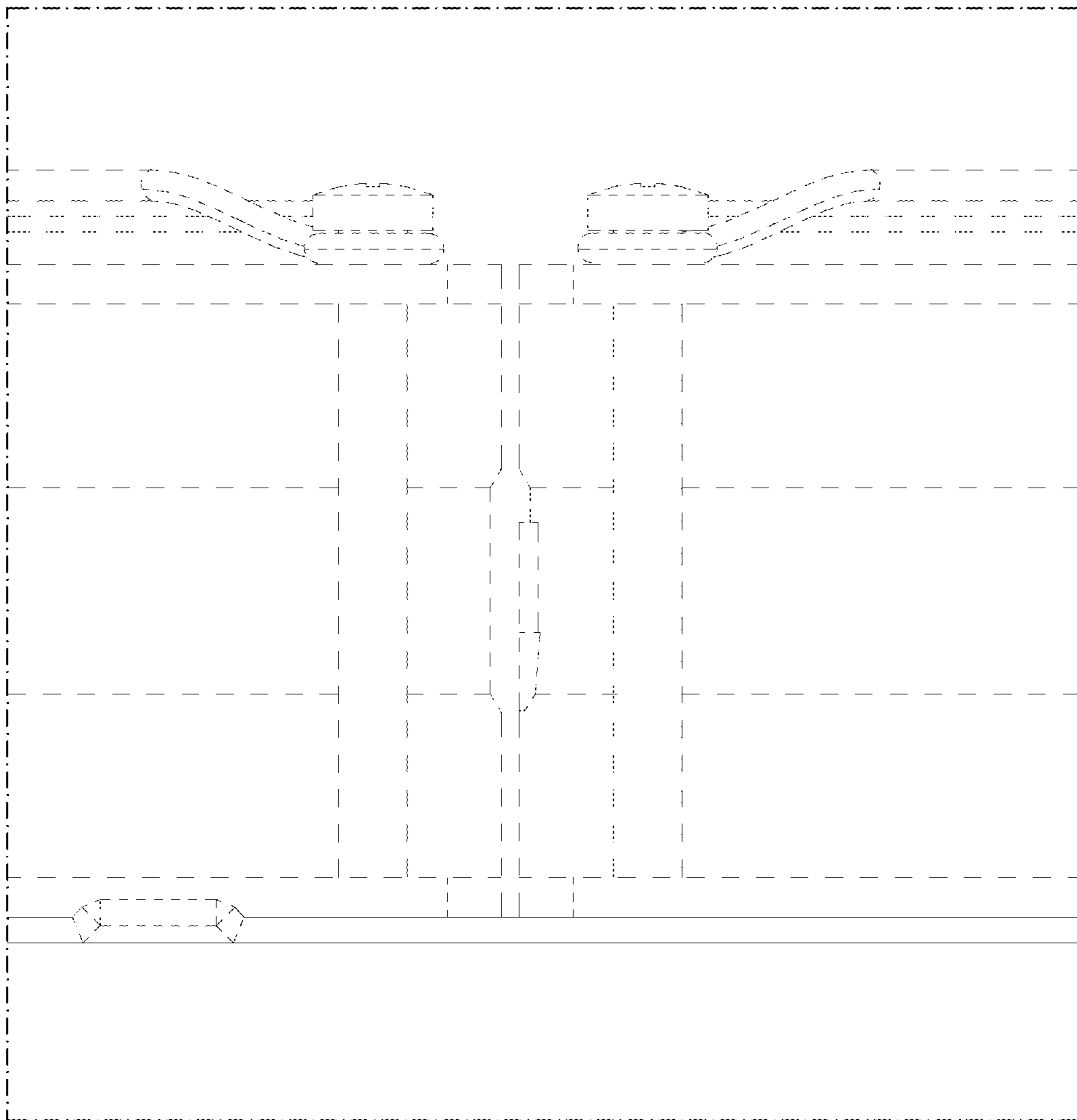

FIG. 33

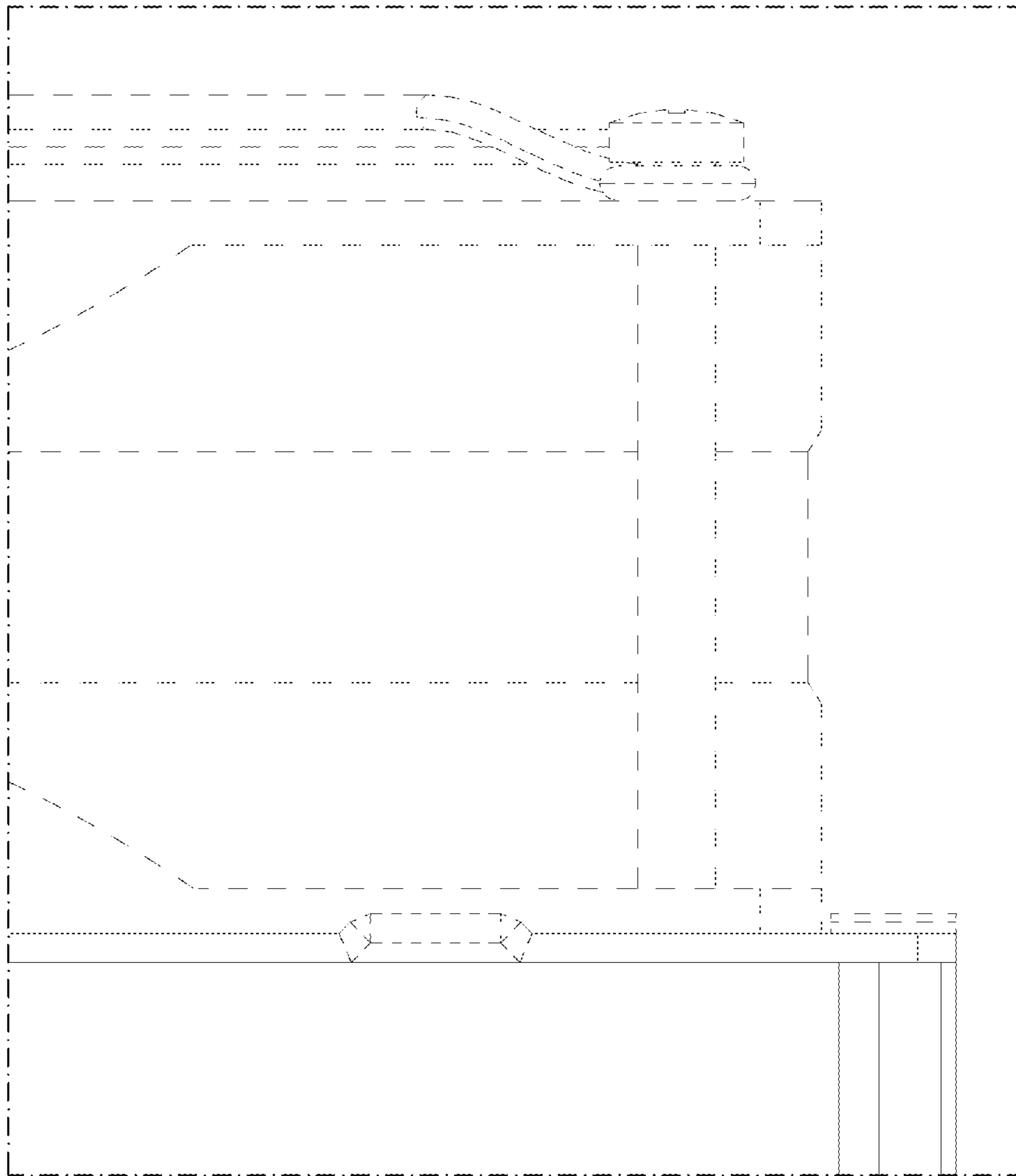

FIG.34

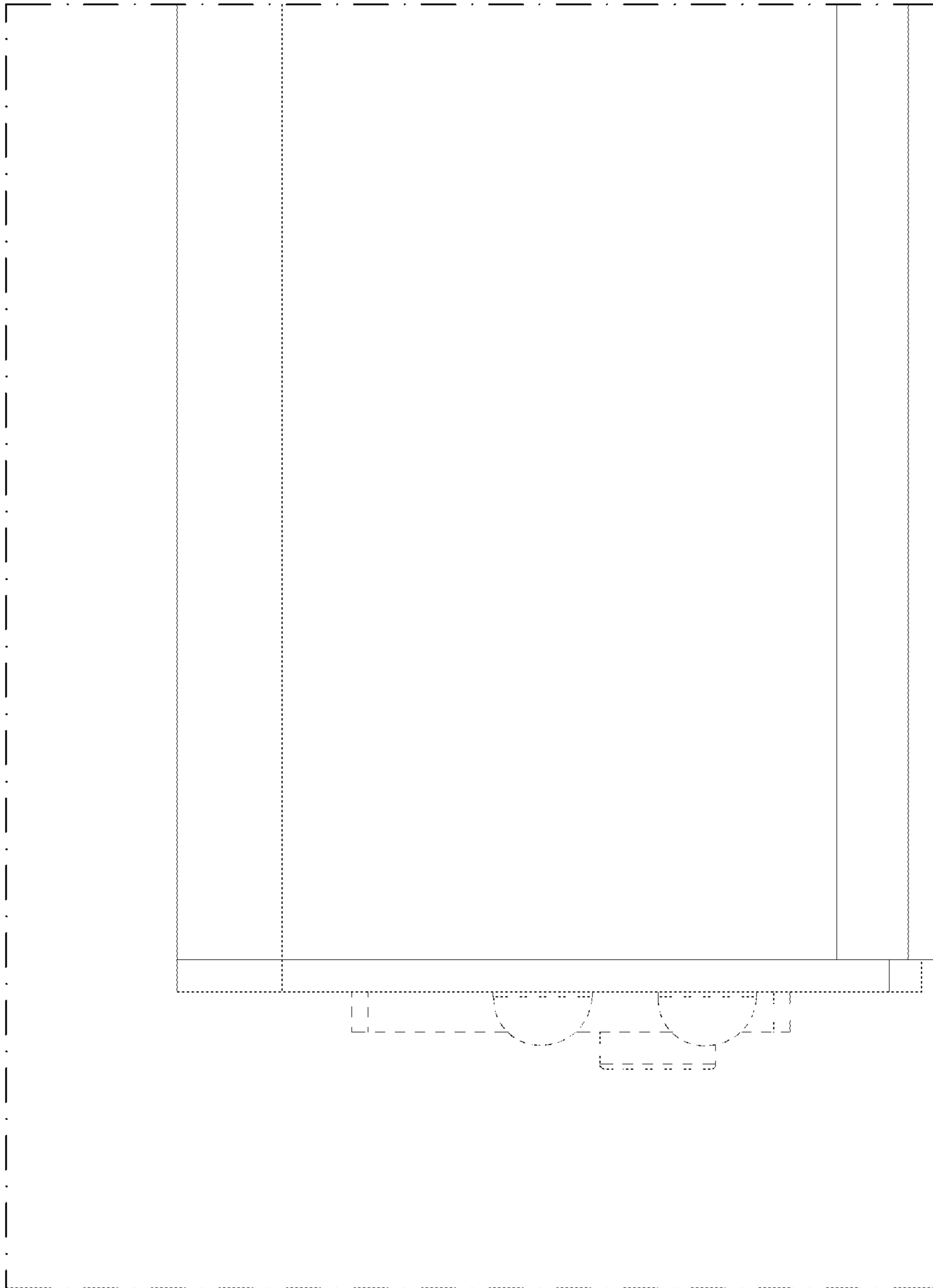

FIG.35

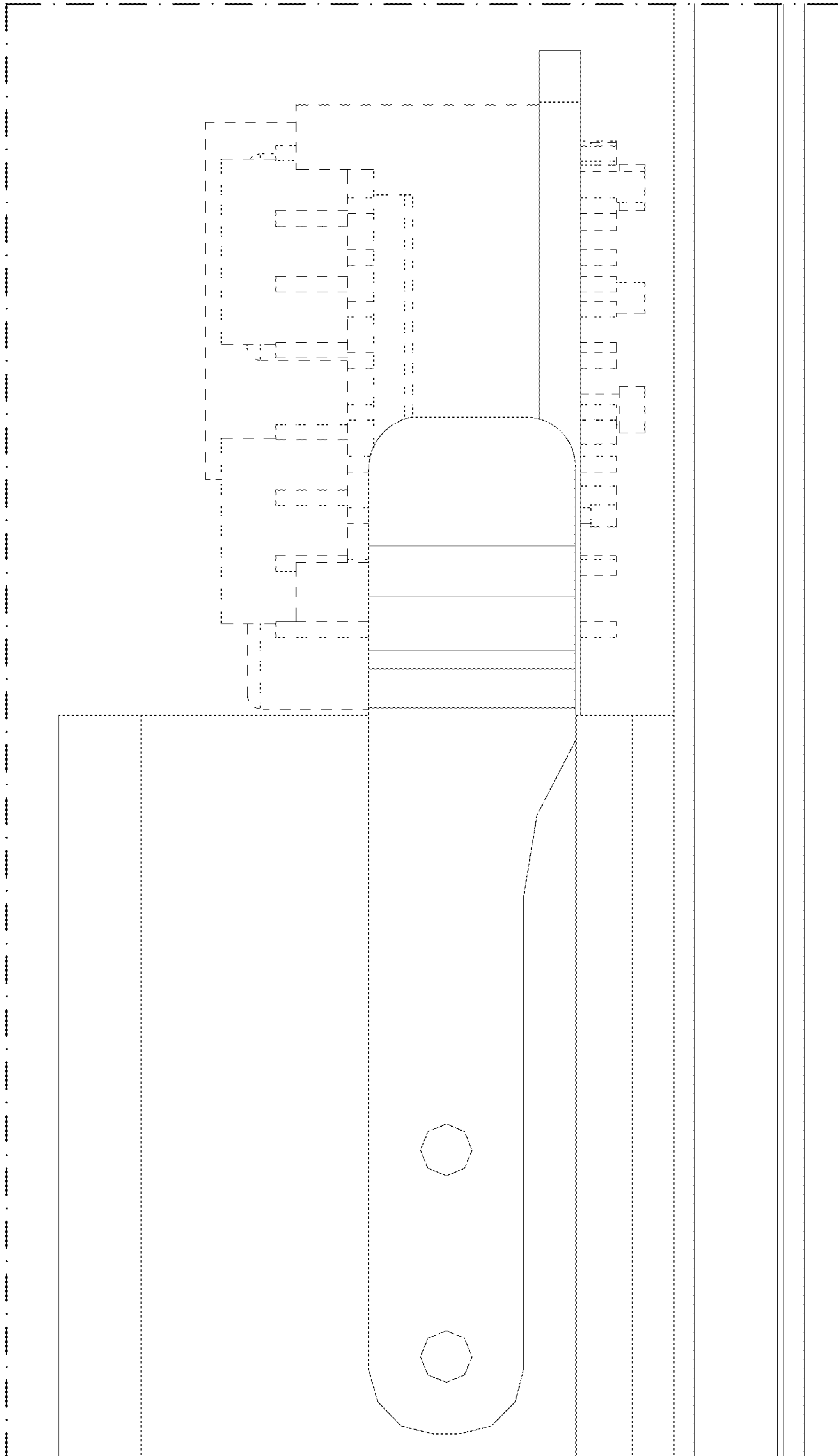

FIG.36

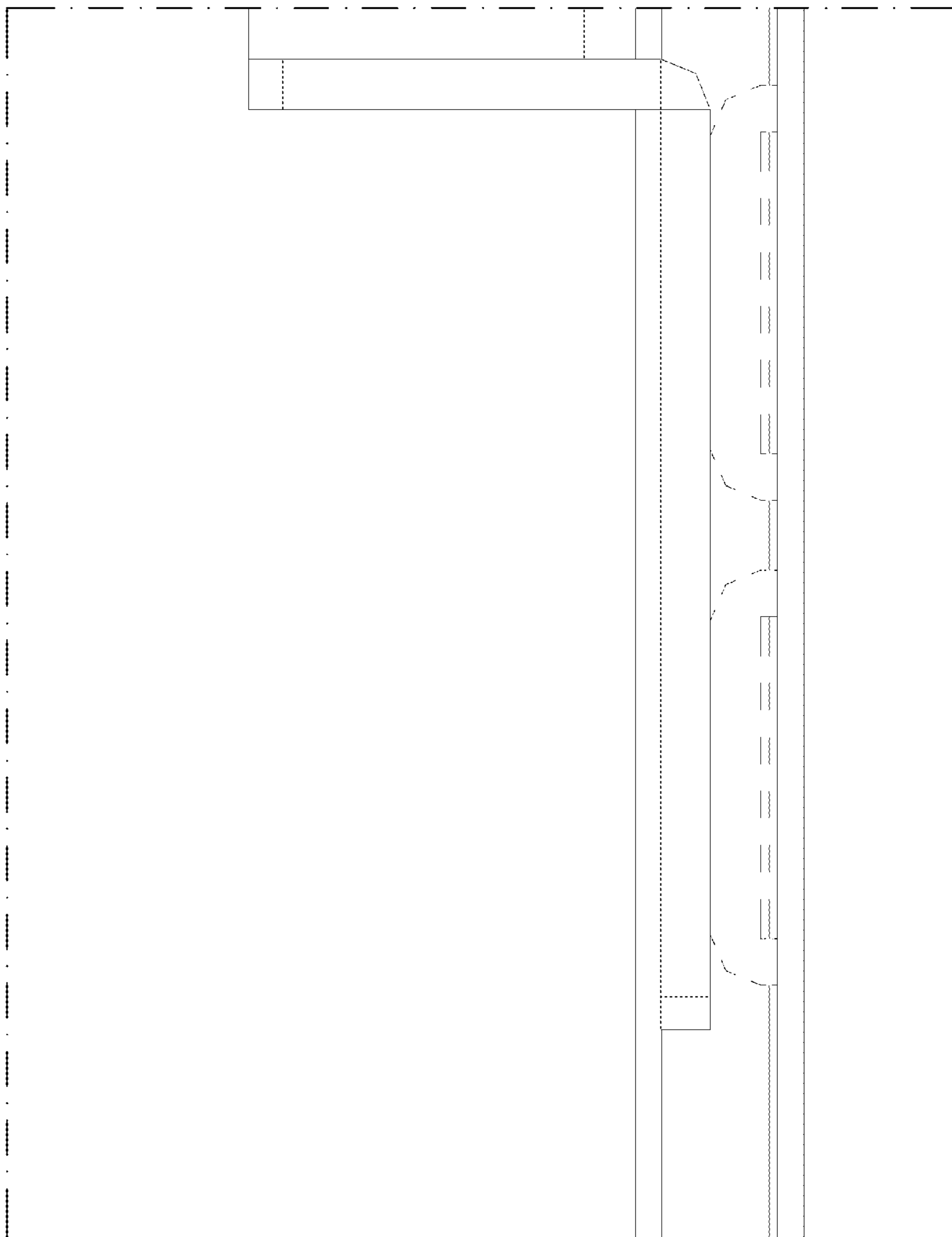

FIG.37

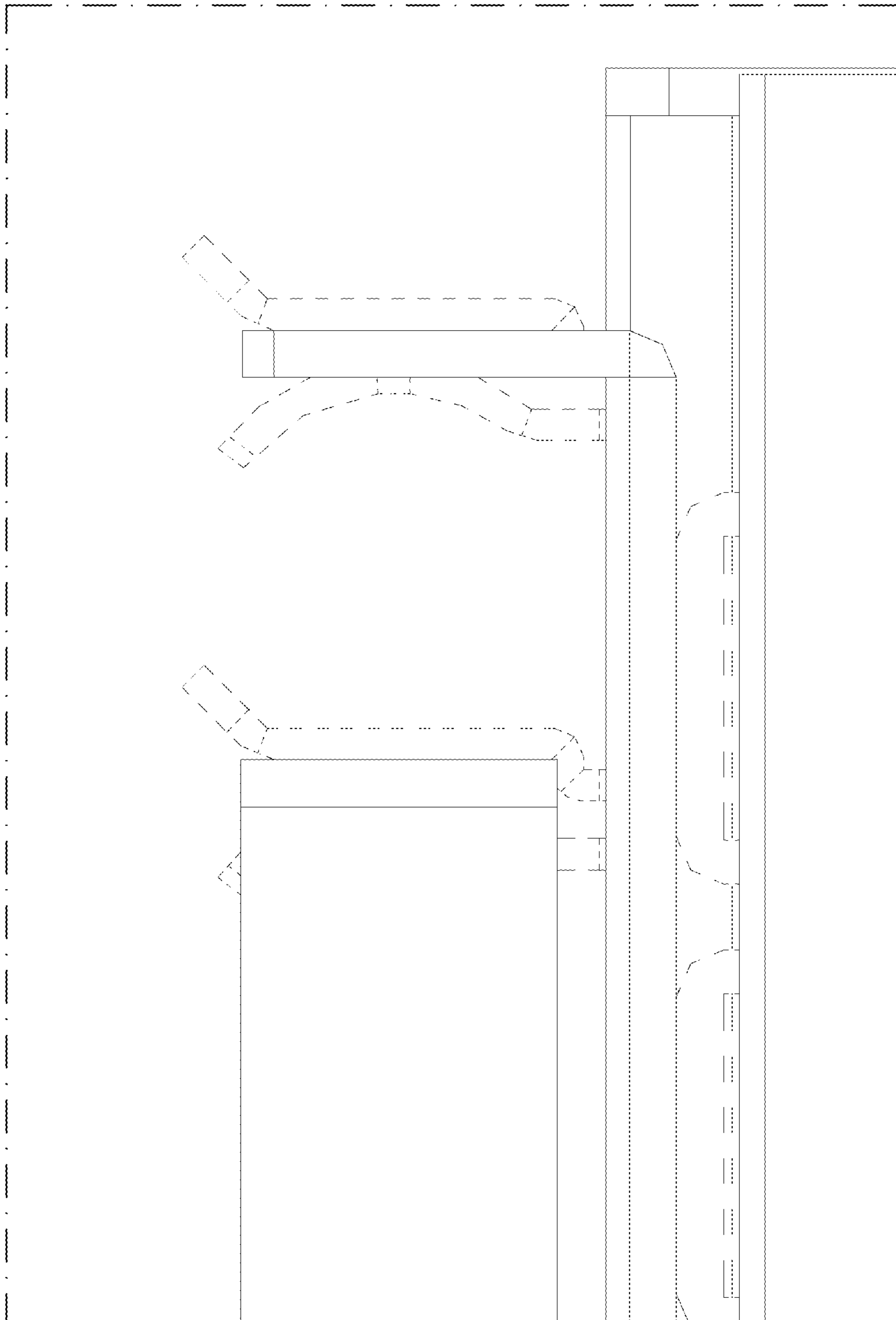

FIG.38

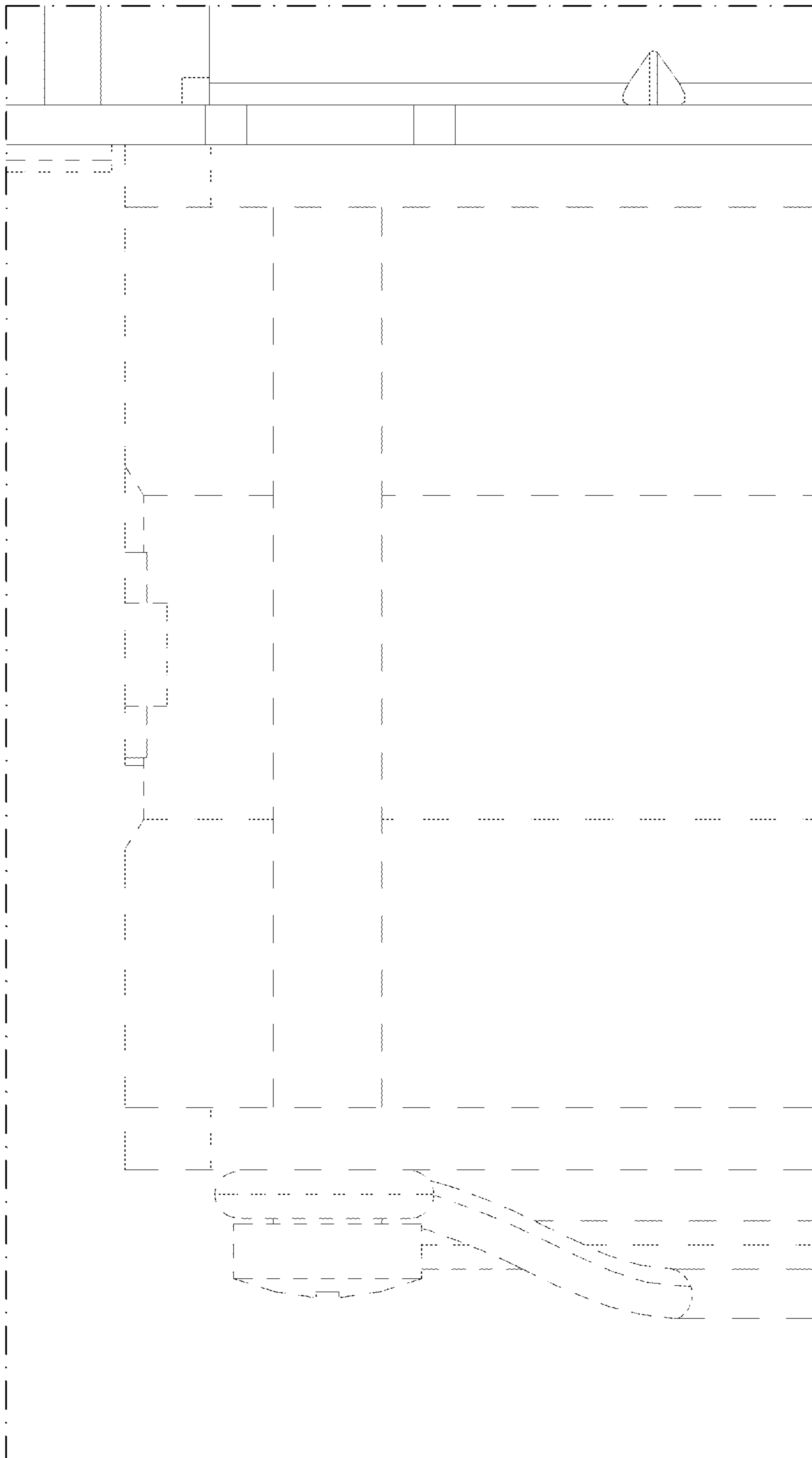

FIG.39

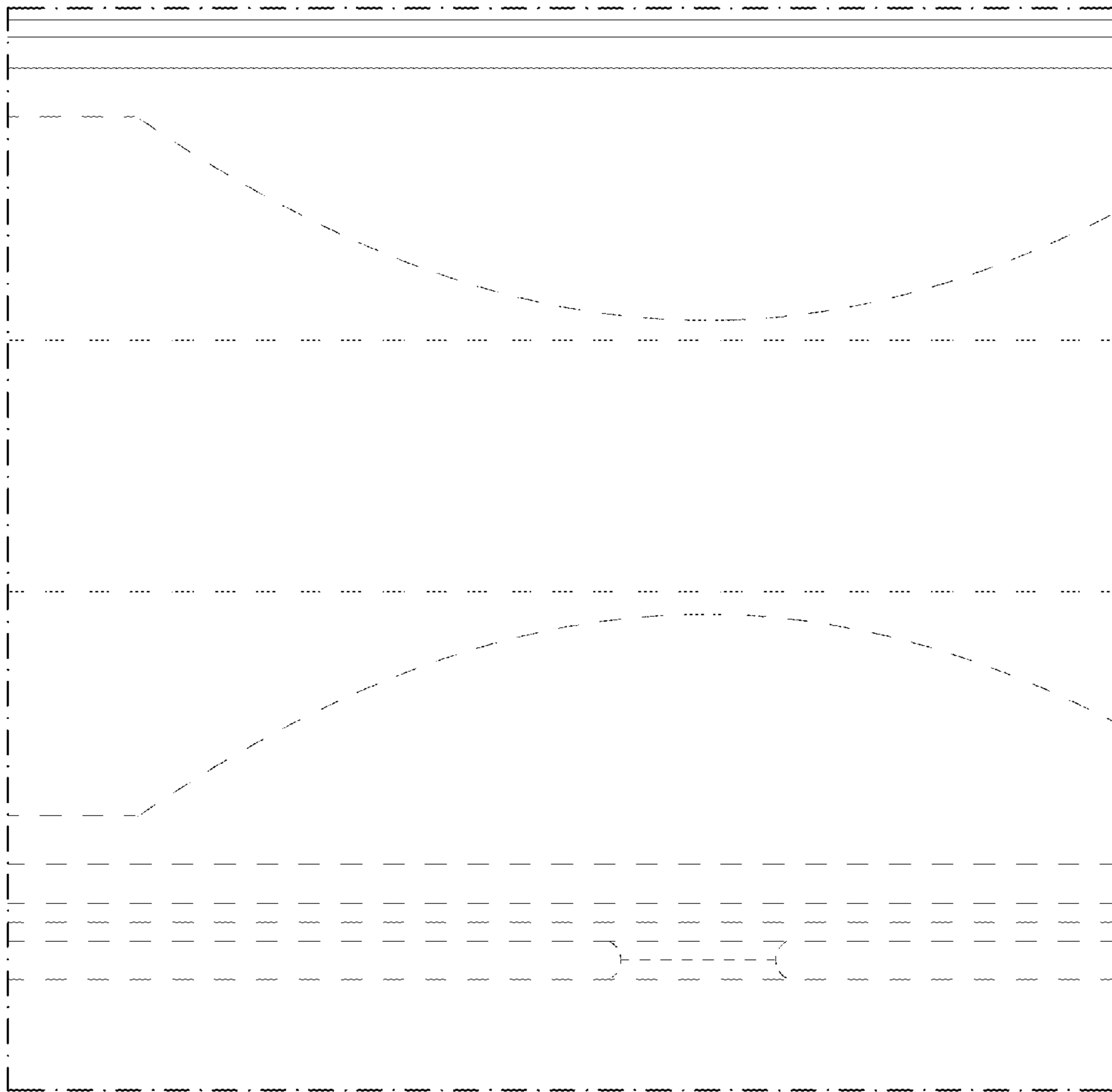

FIG.40

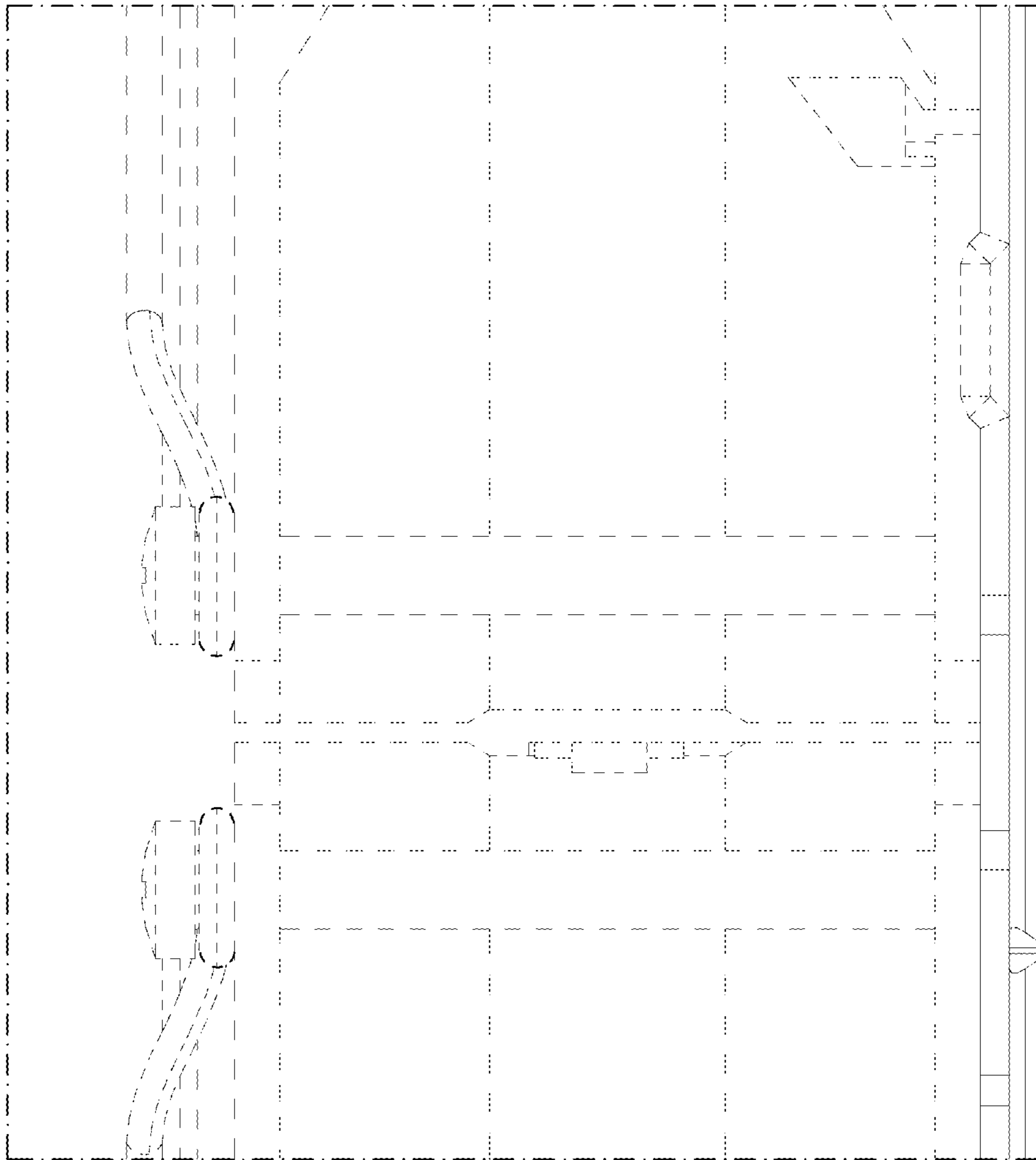

FIG. 41

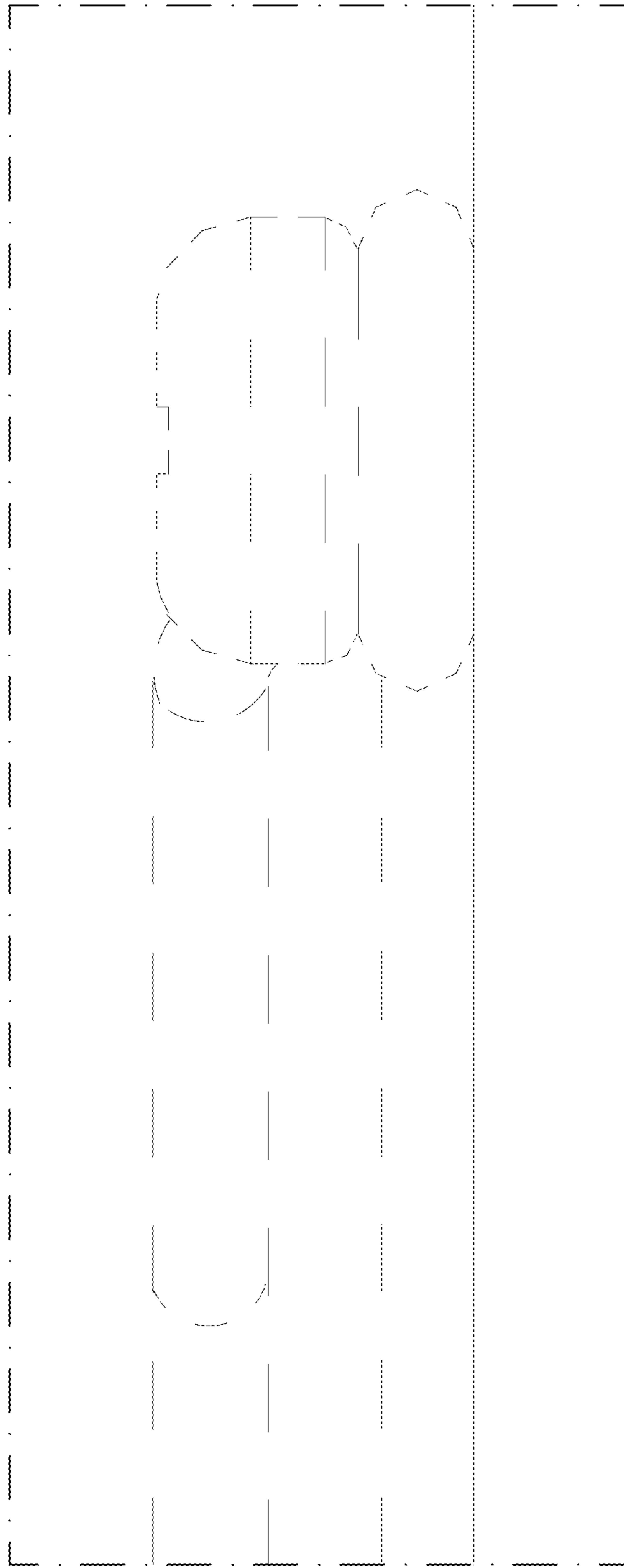

FIG. 42

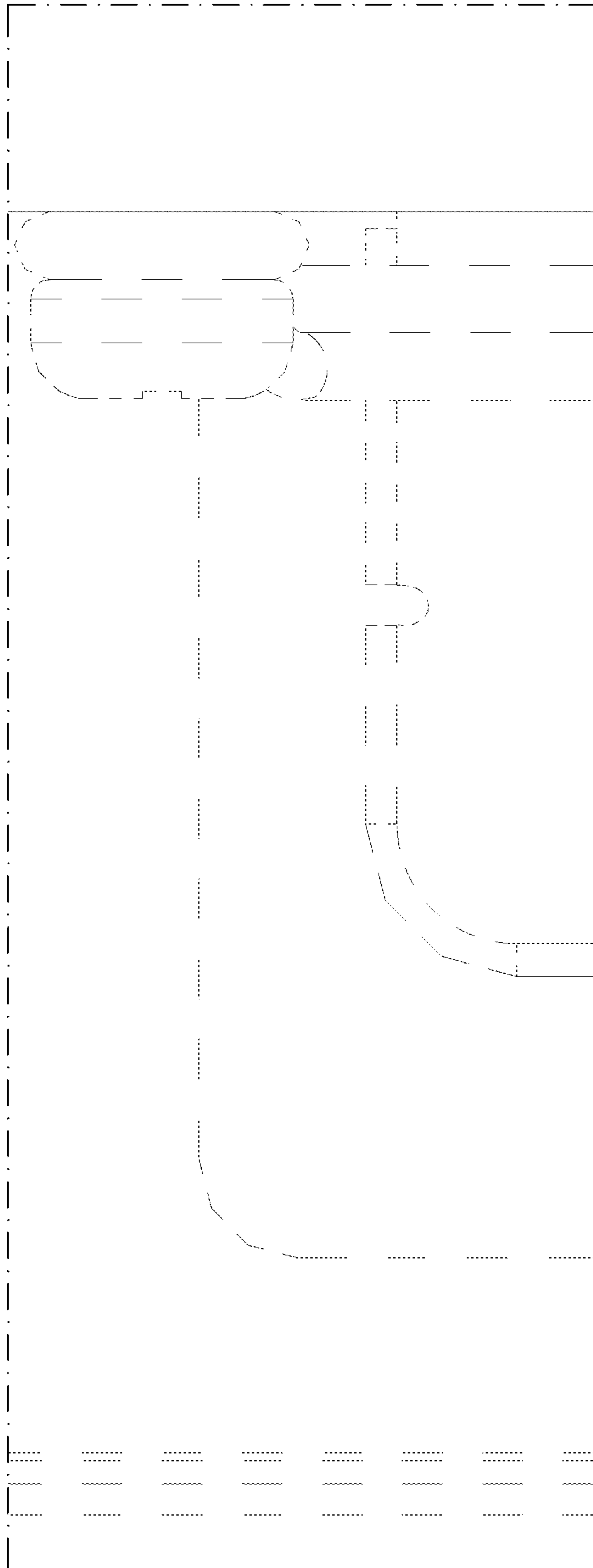

FIG.43

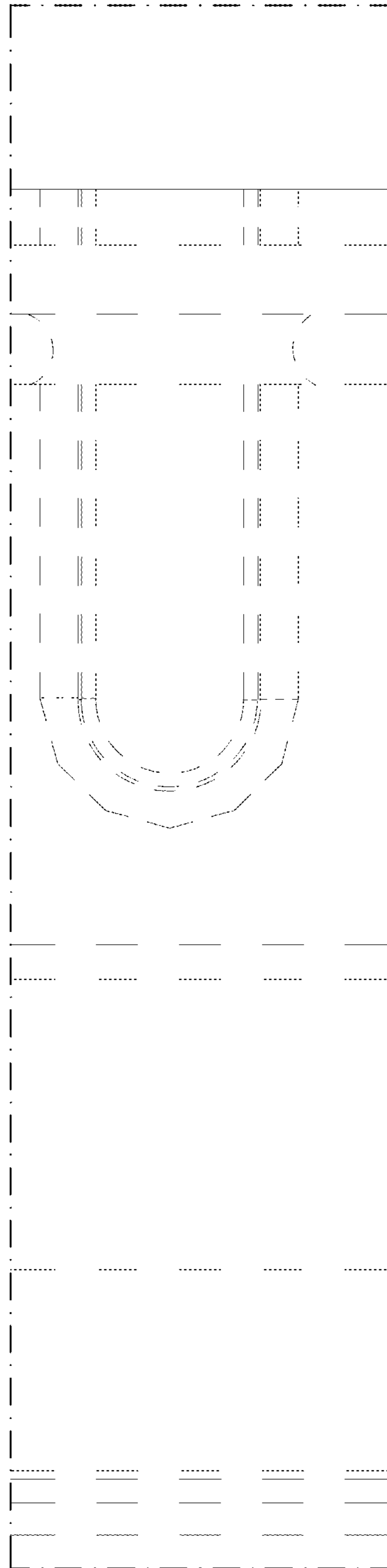

FIG.44

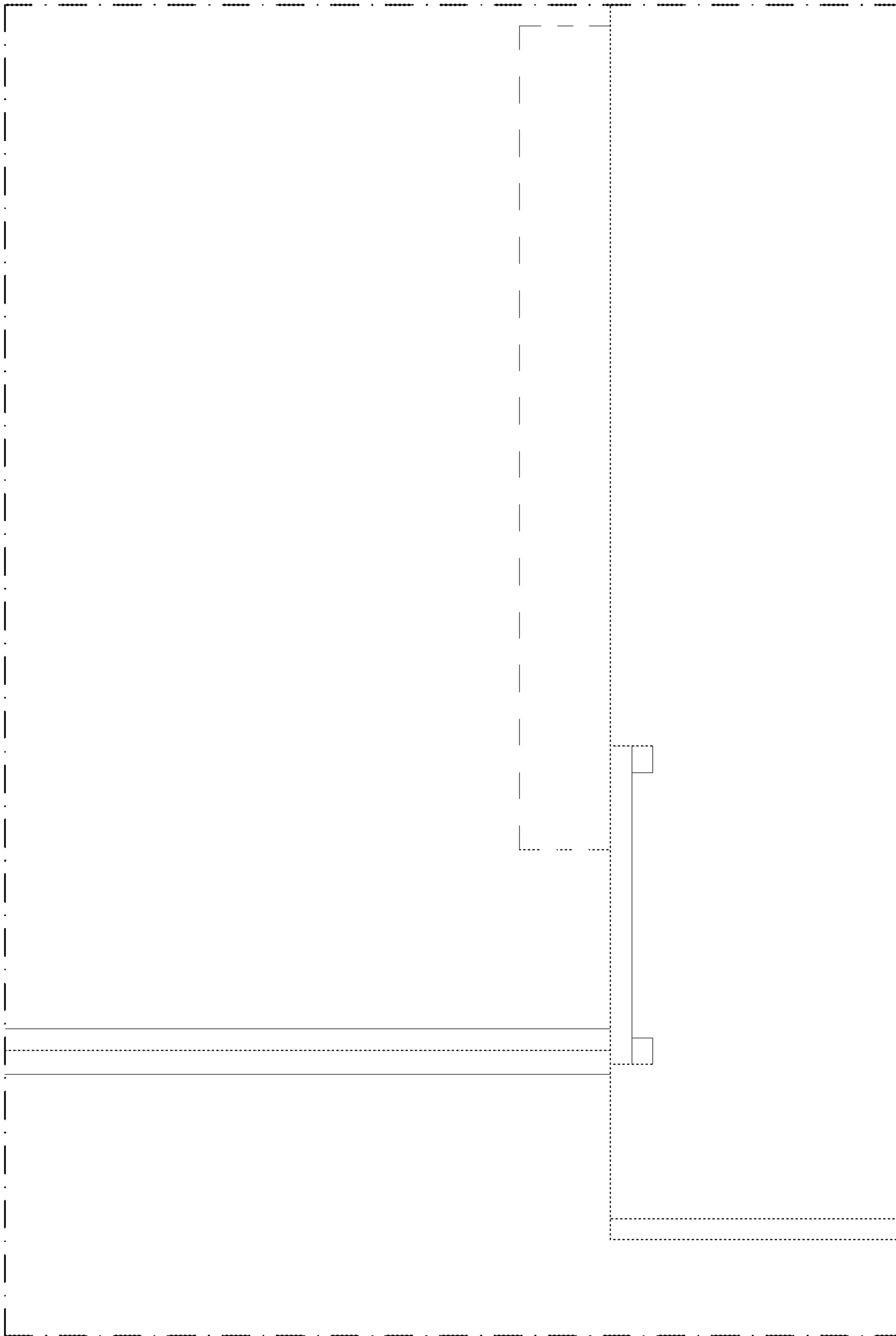

FIG. 45

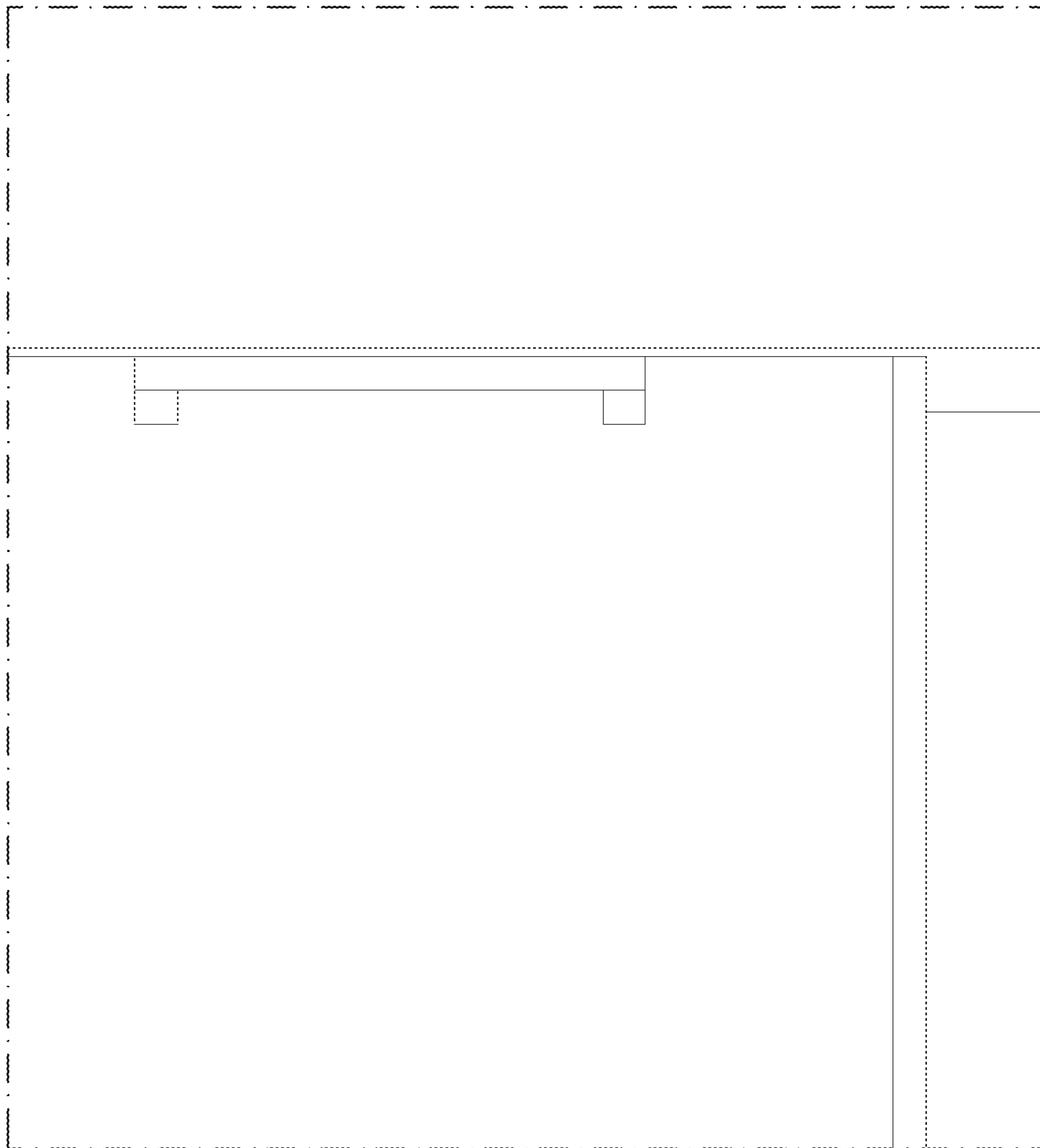

FIG. 46

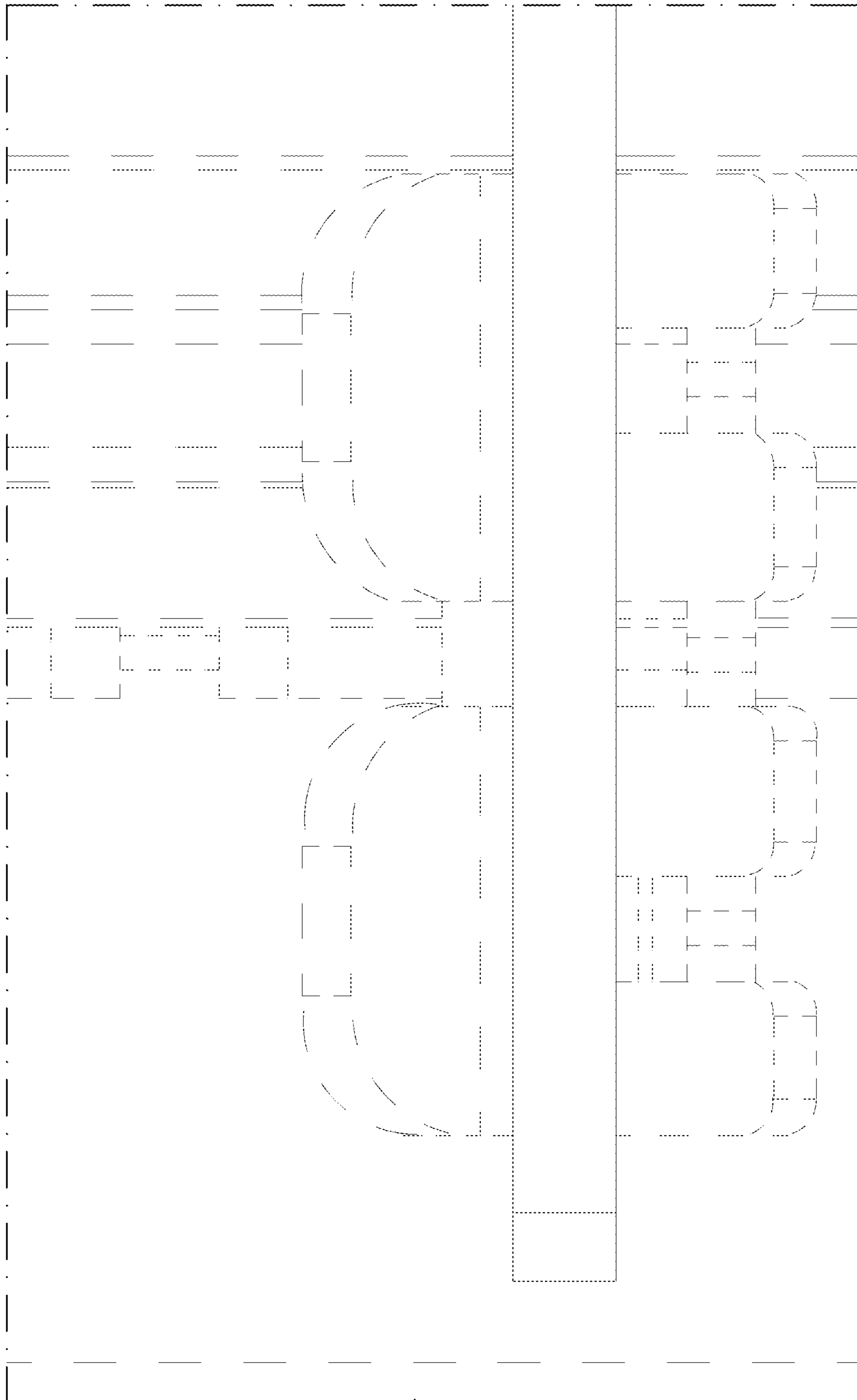

FIG.47

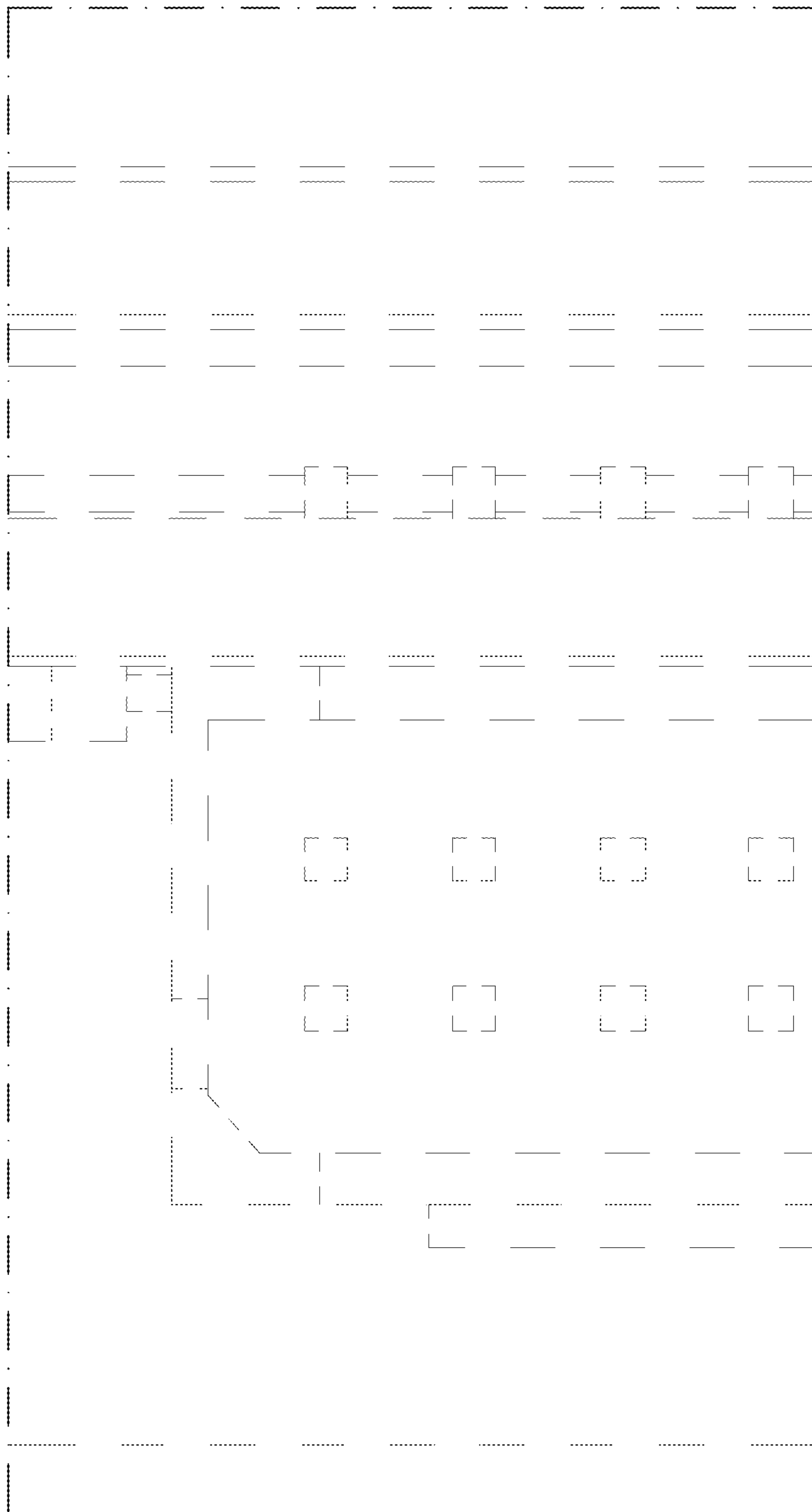

FIG. 48

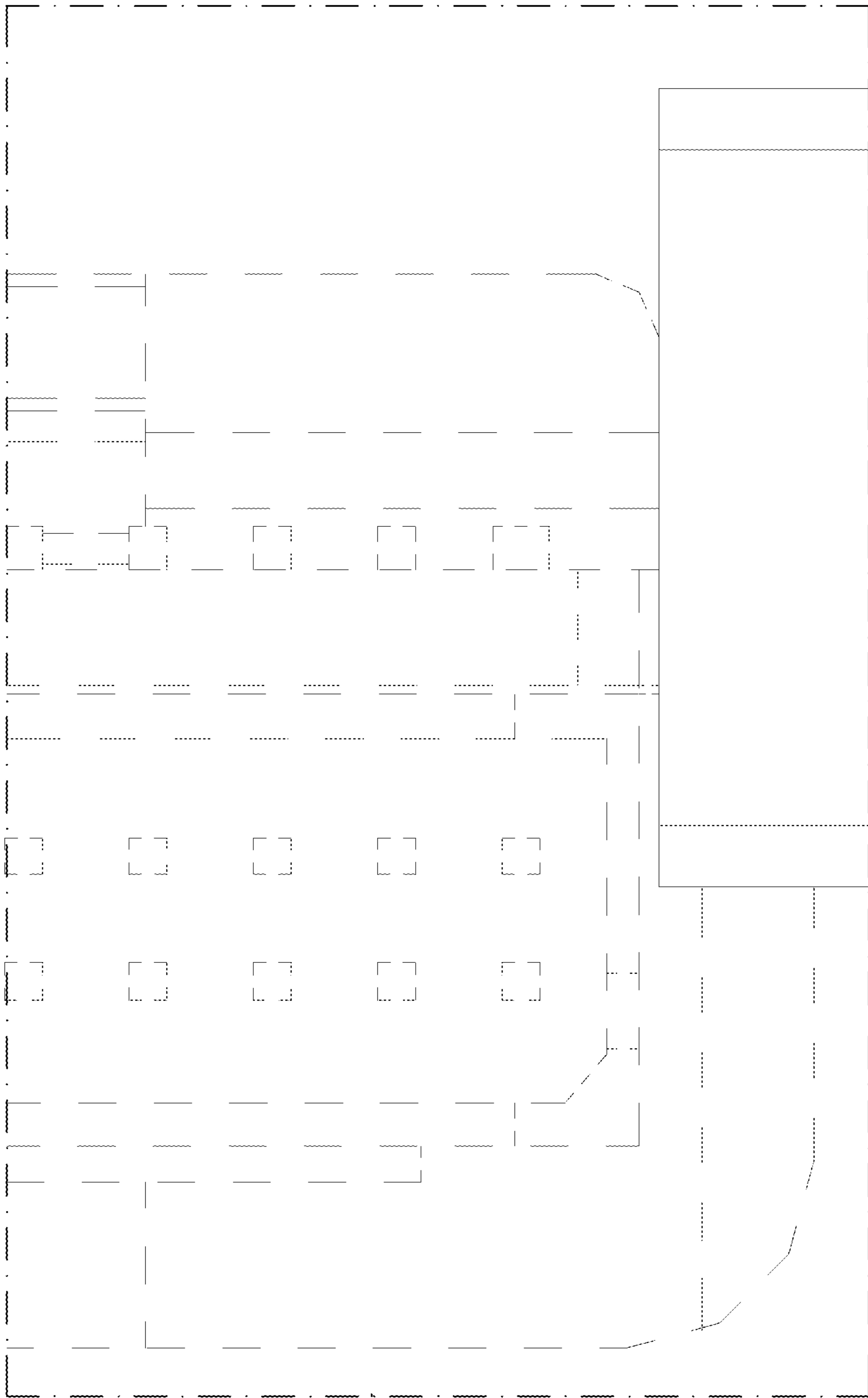

FIG. 49

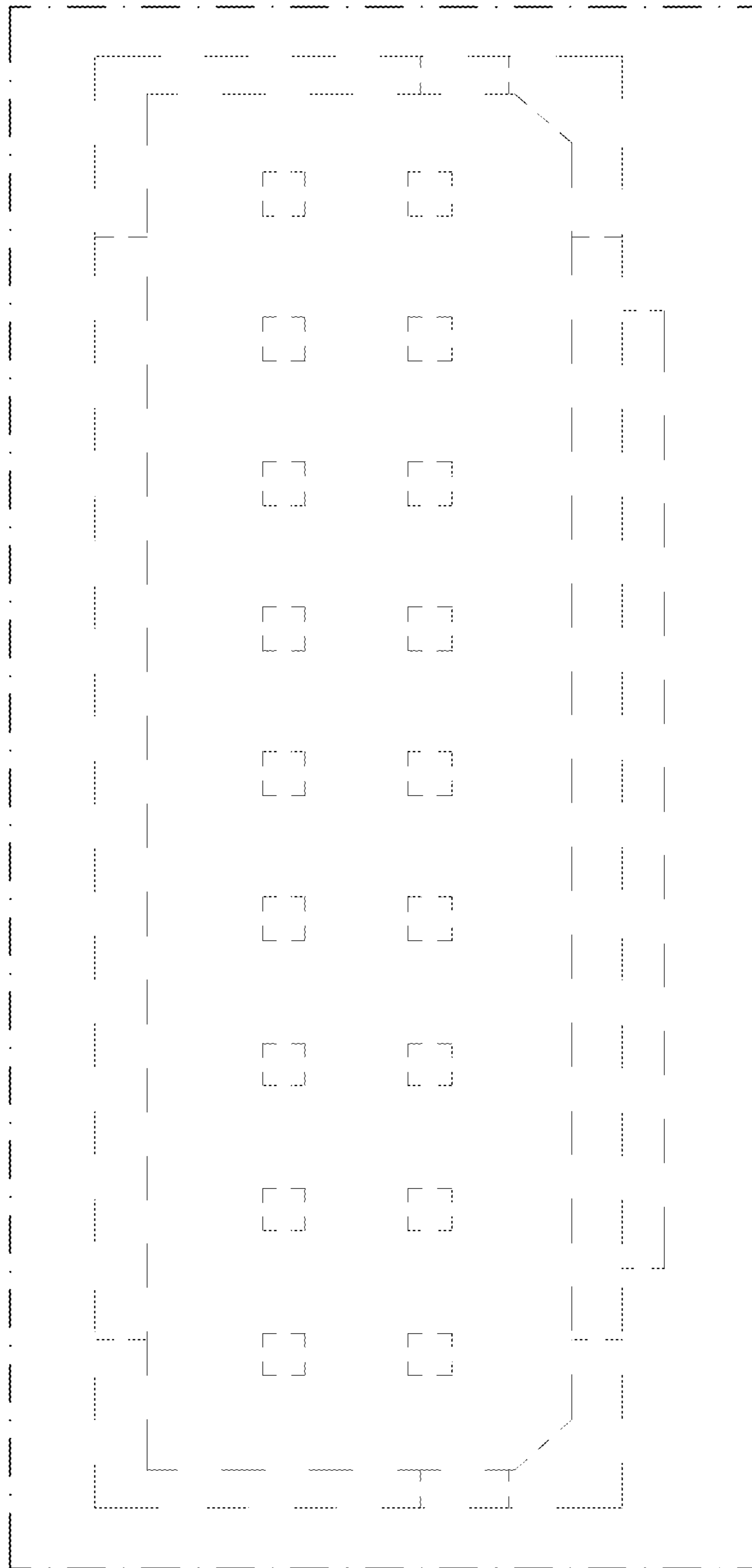

FIG. 50

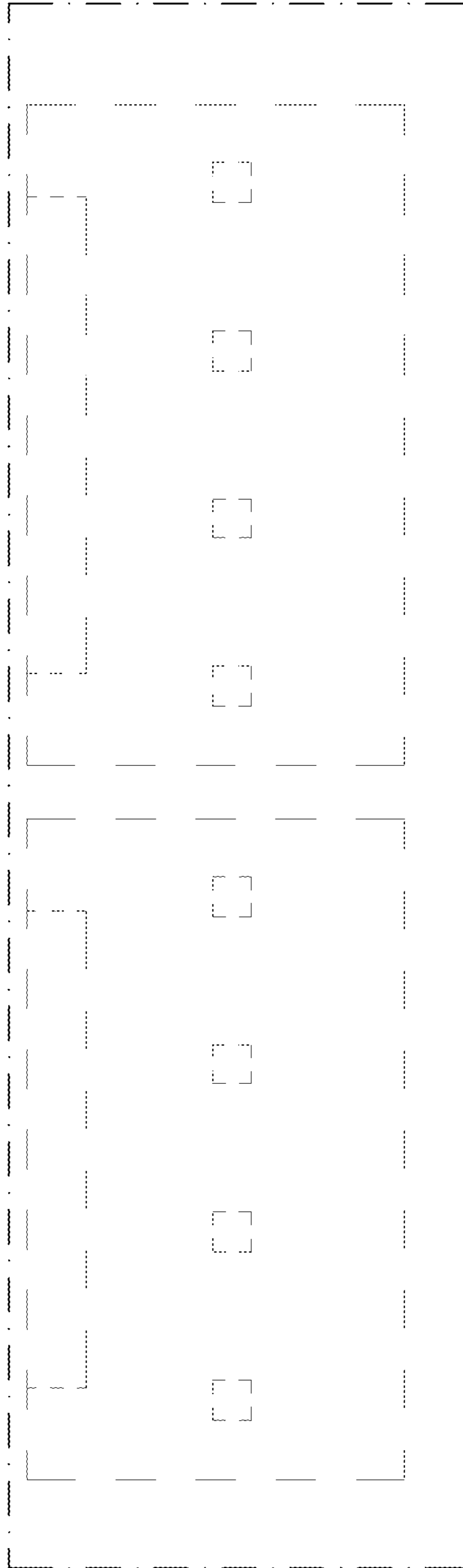

FIG. 51

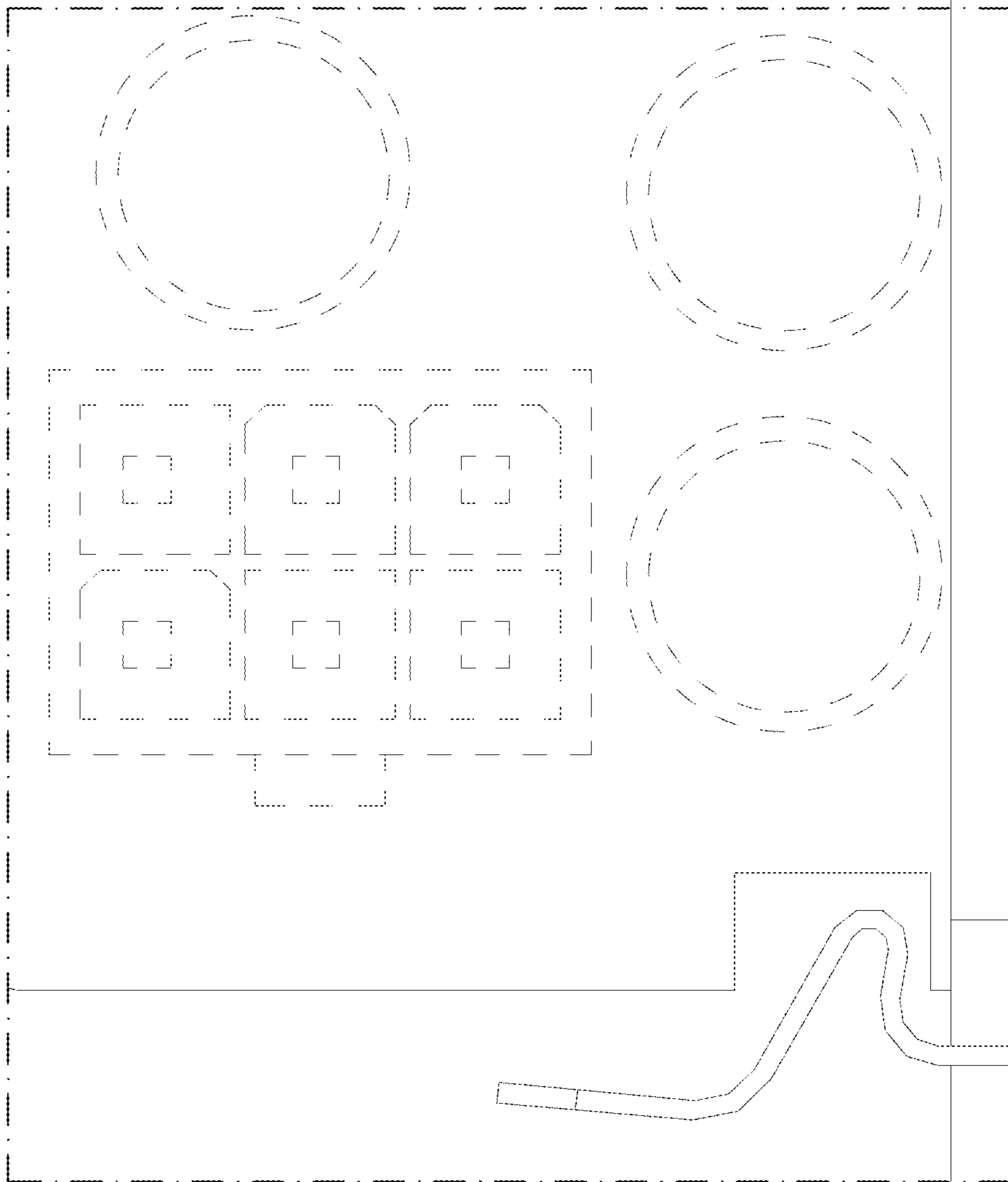

FIG. 52

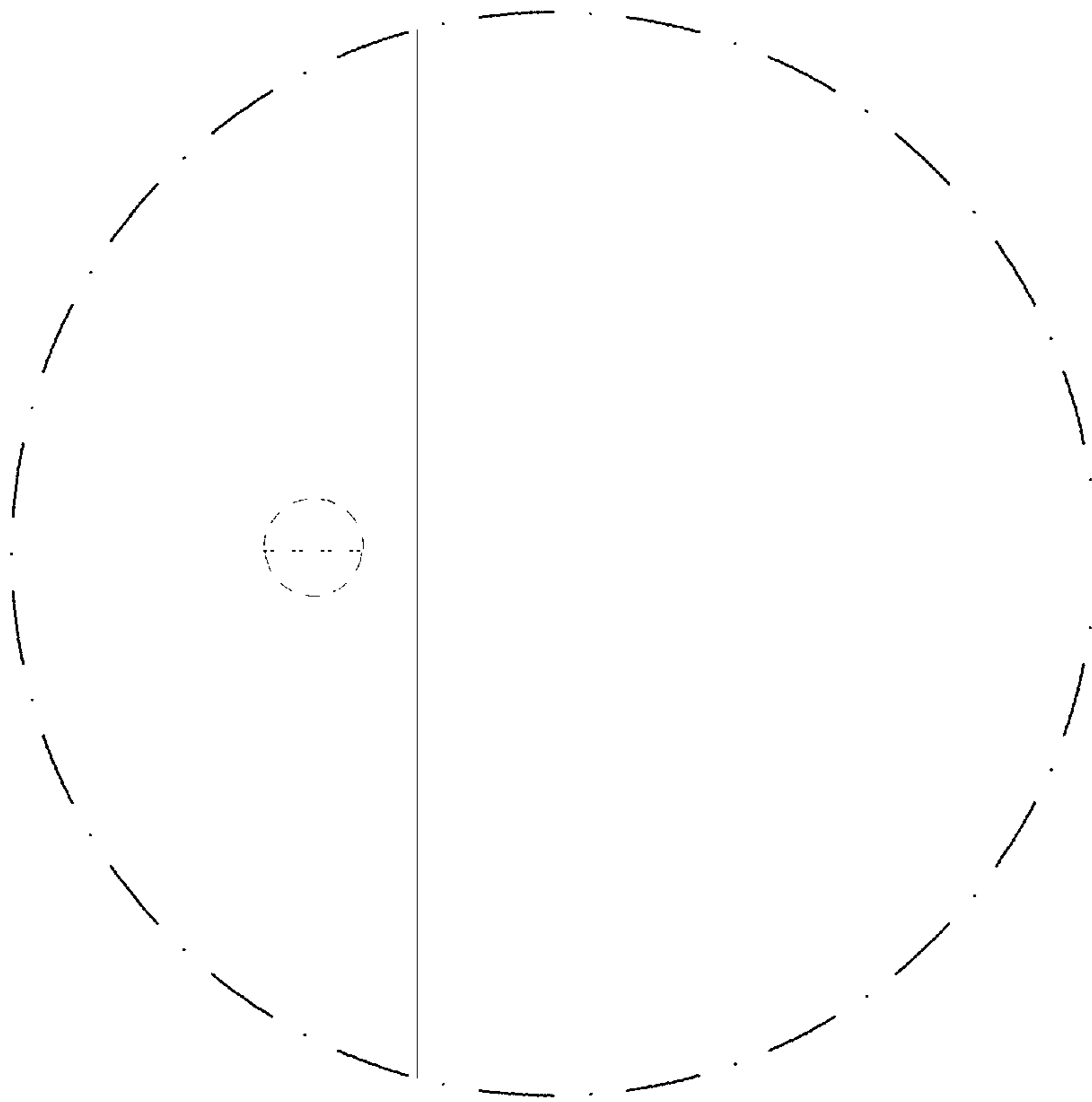

FIG.53

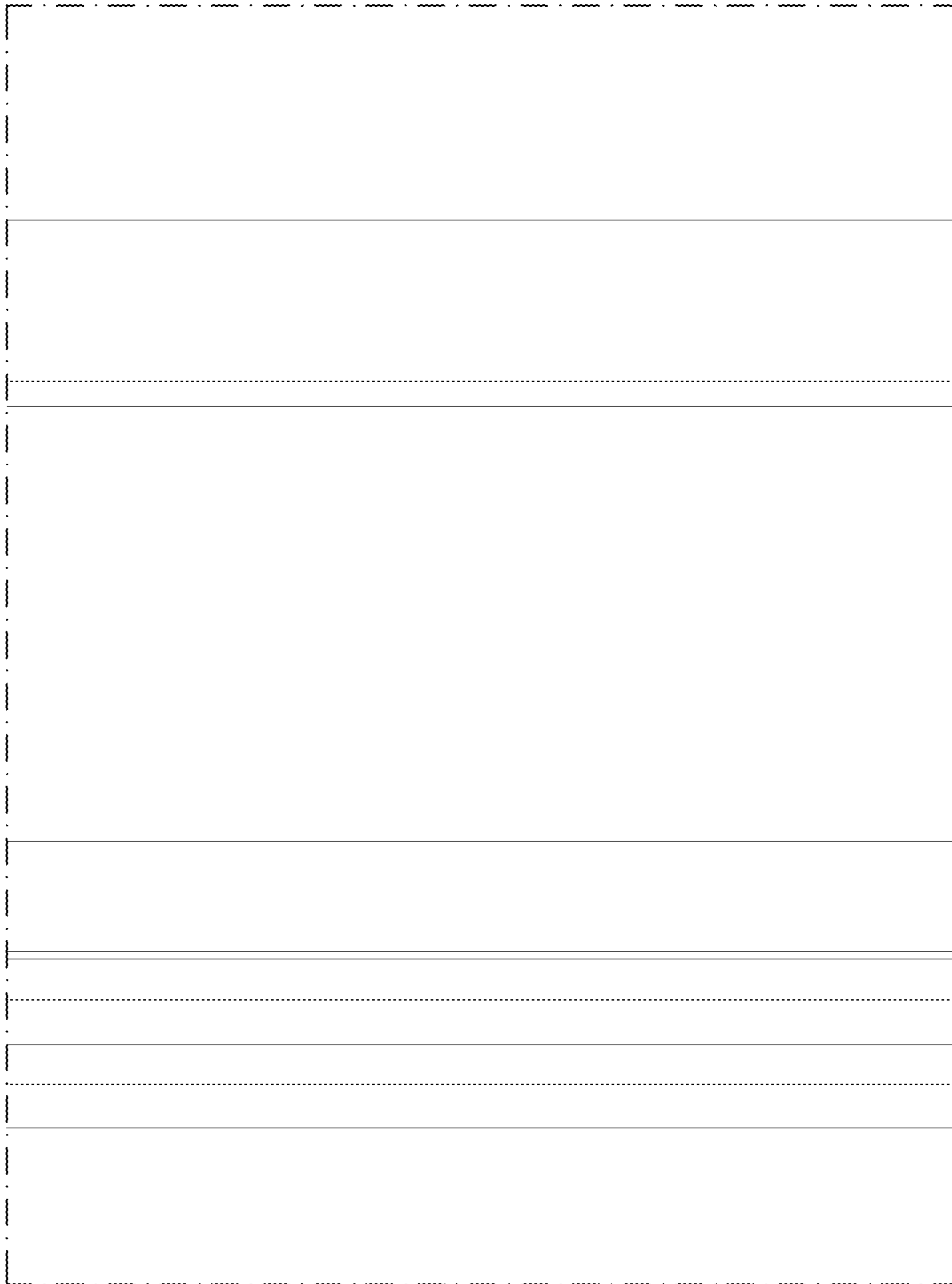

FIG. 54

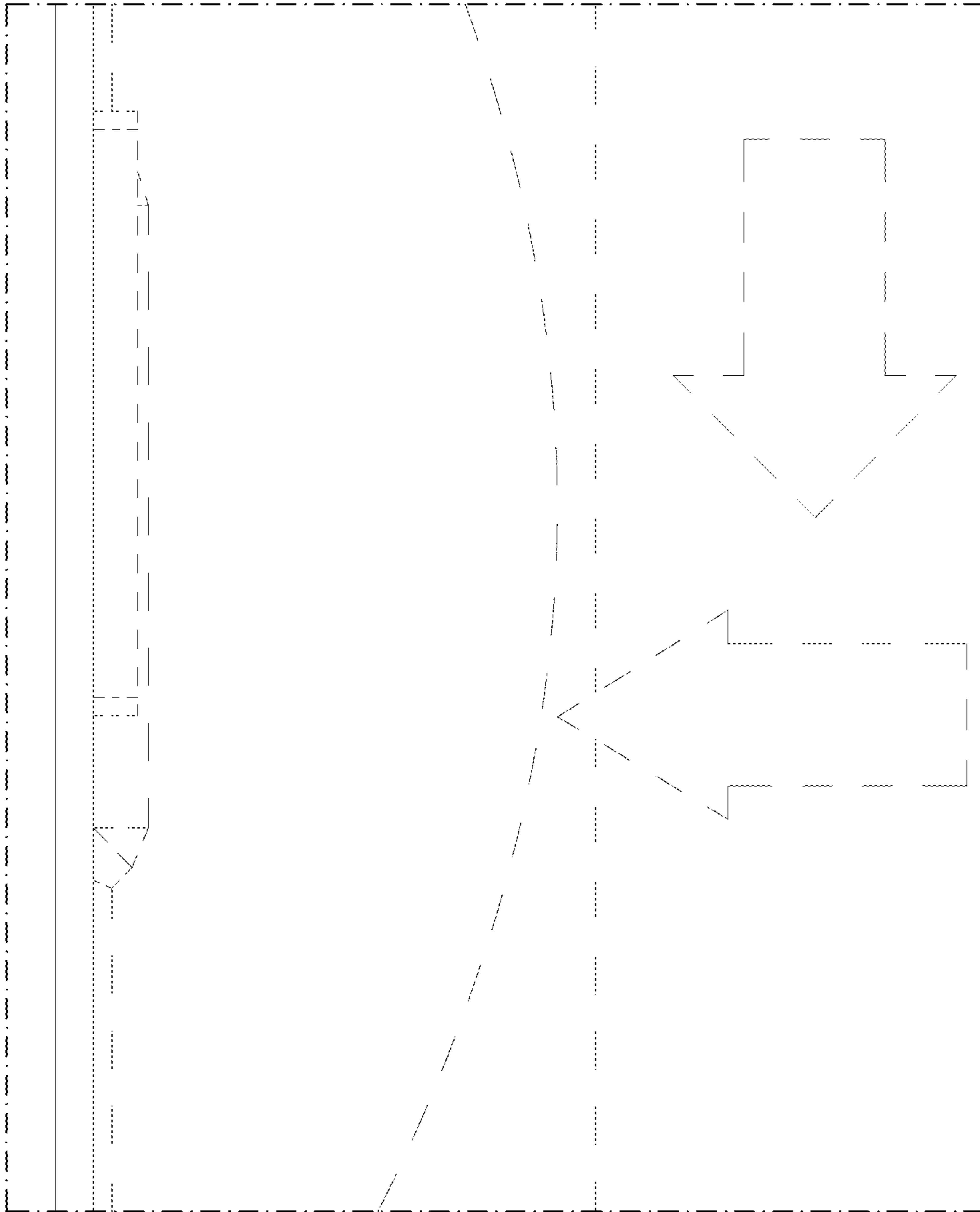

FIG.55

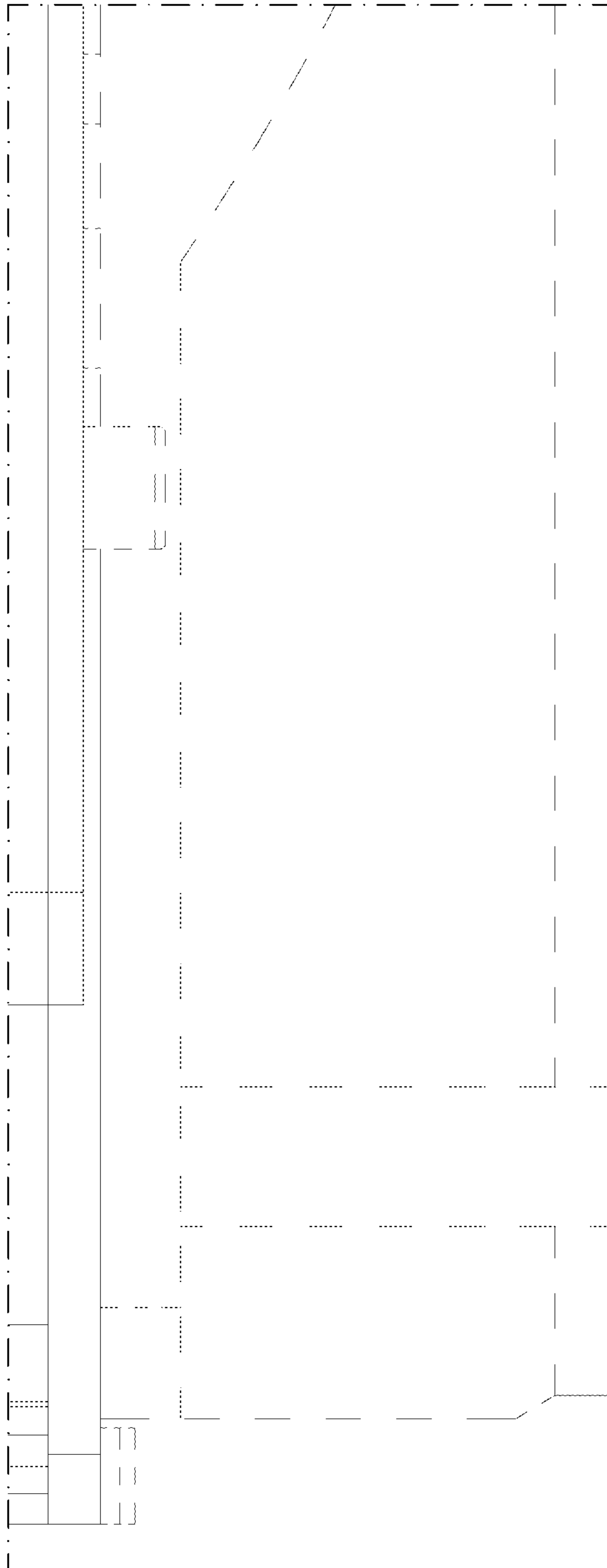

FIG. 56

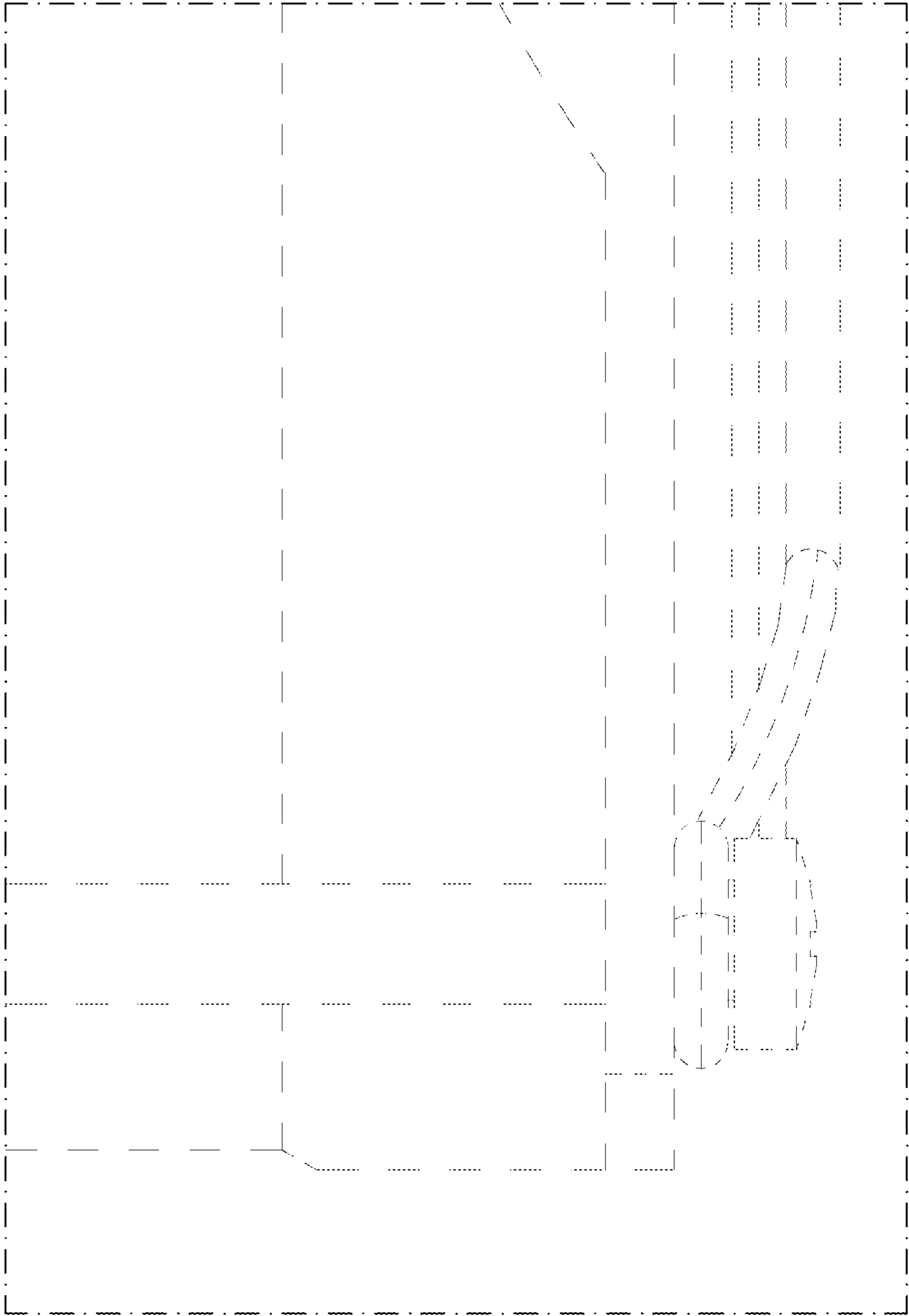

FIG. 57



FIG.58

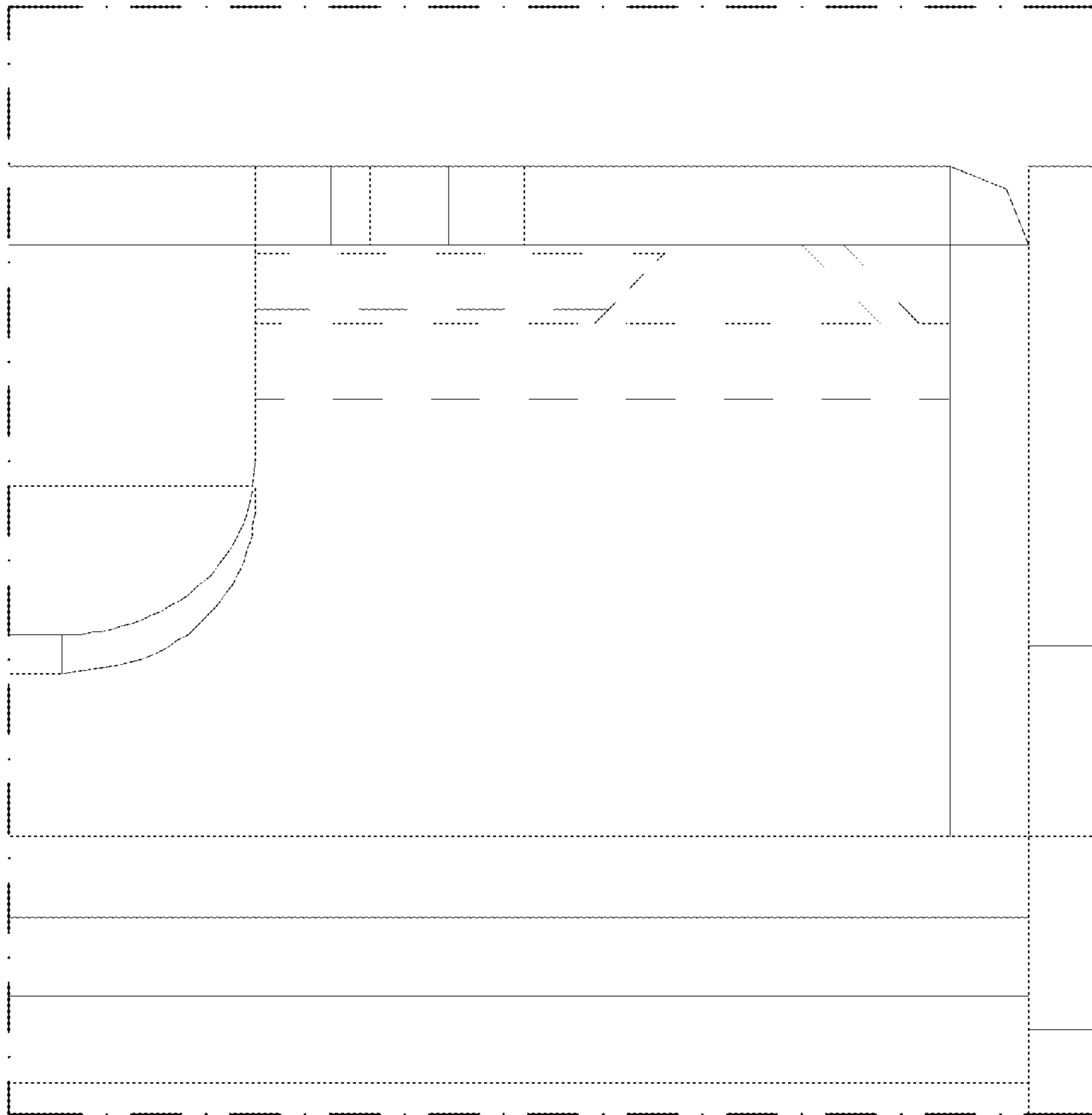

FIG. 59

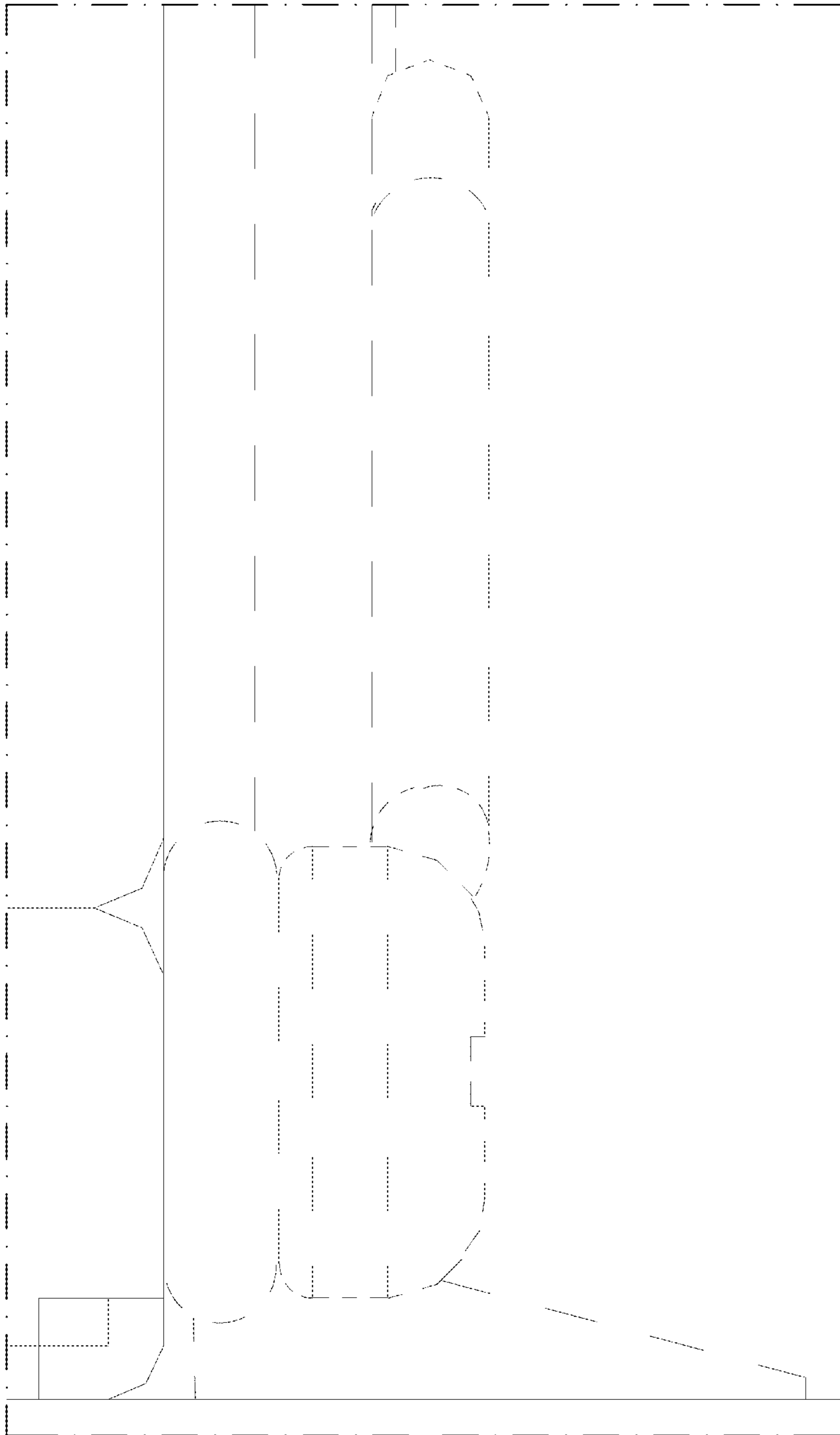

FIG. 60

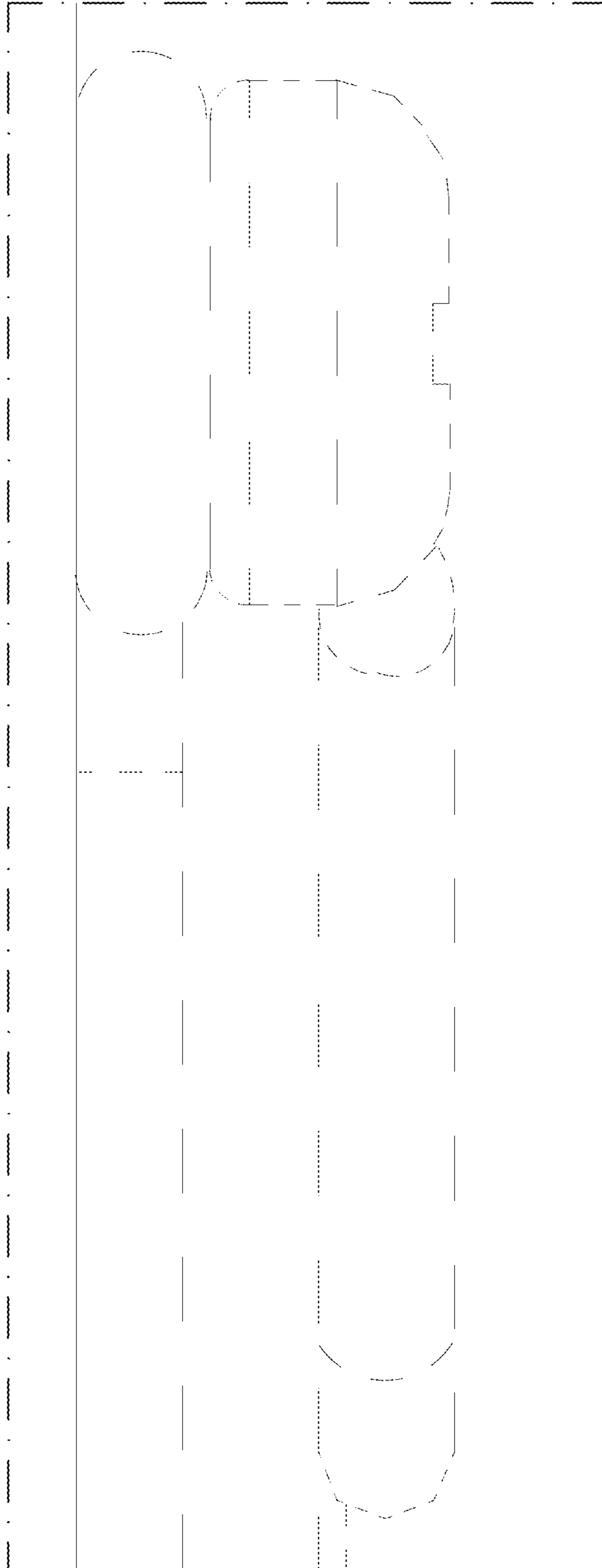

FIG. 61

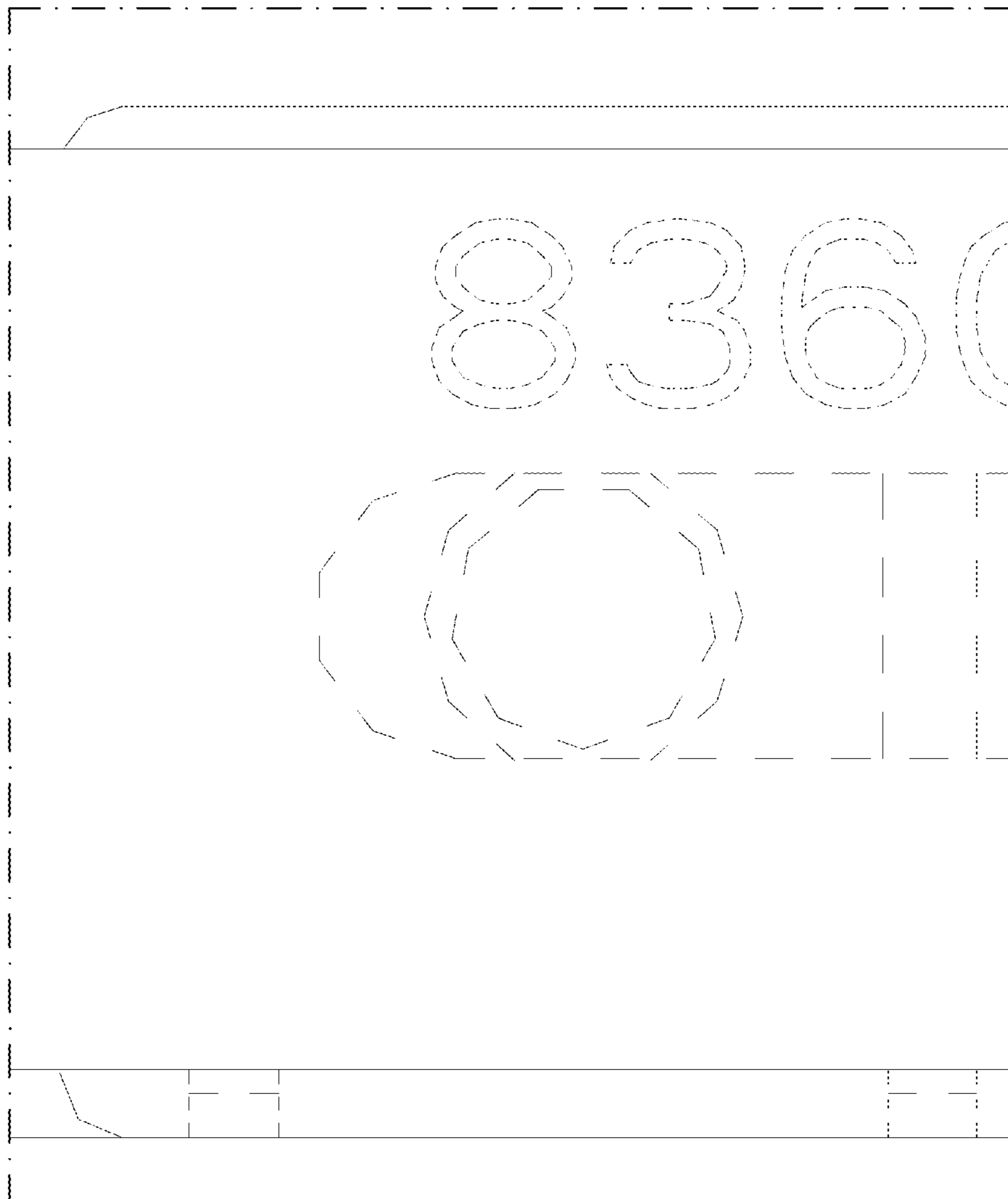

FIG. 62

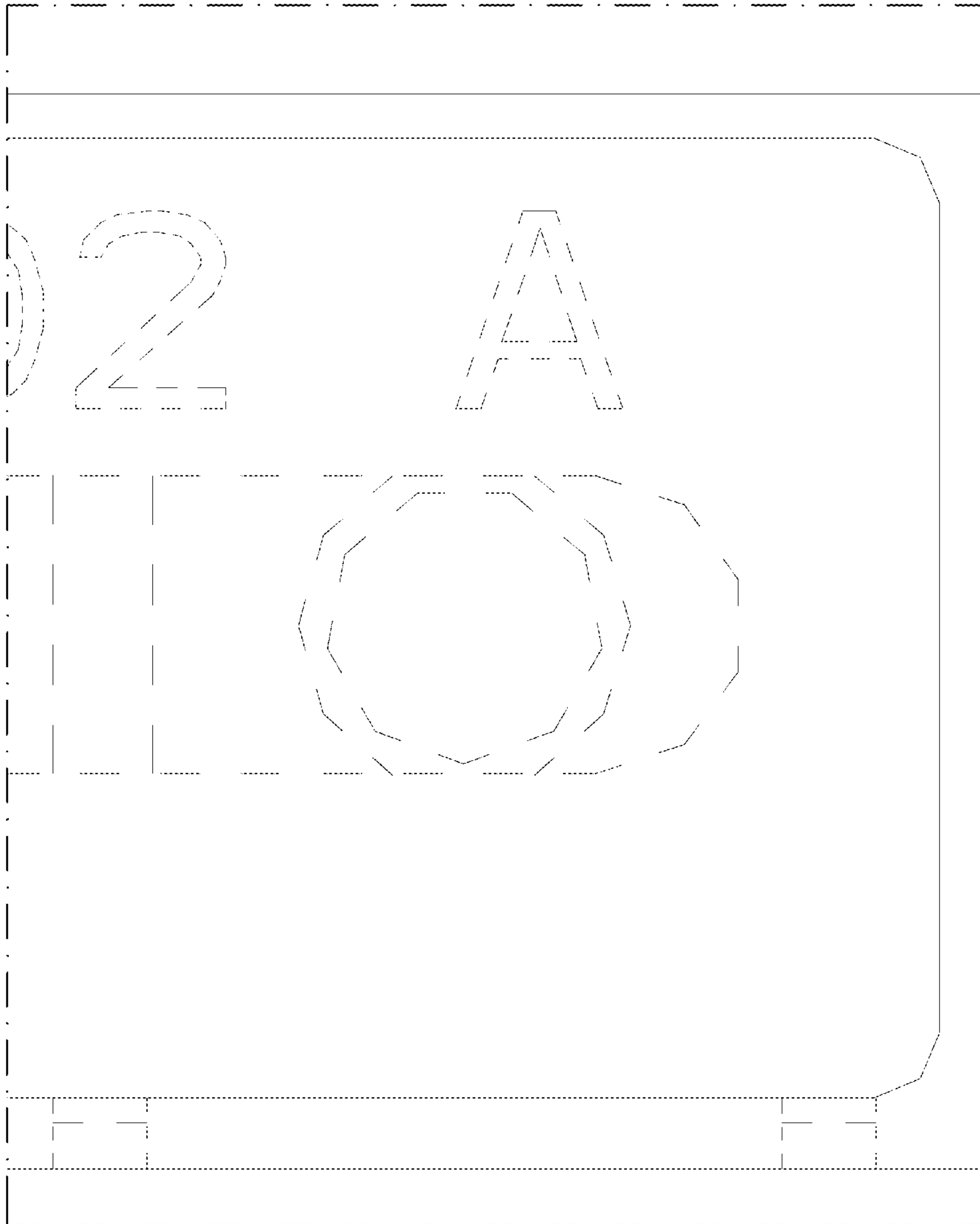

FIG.63

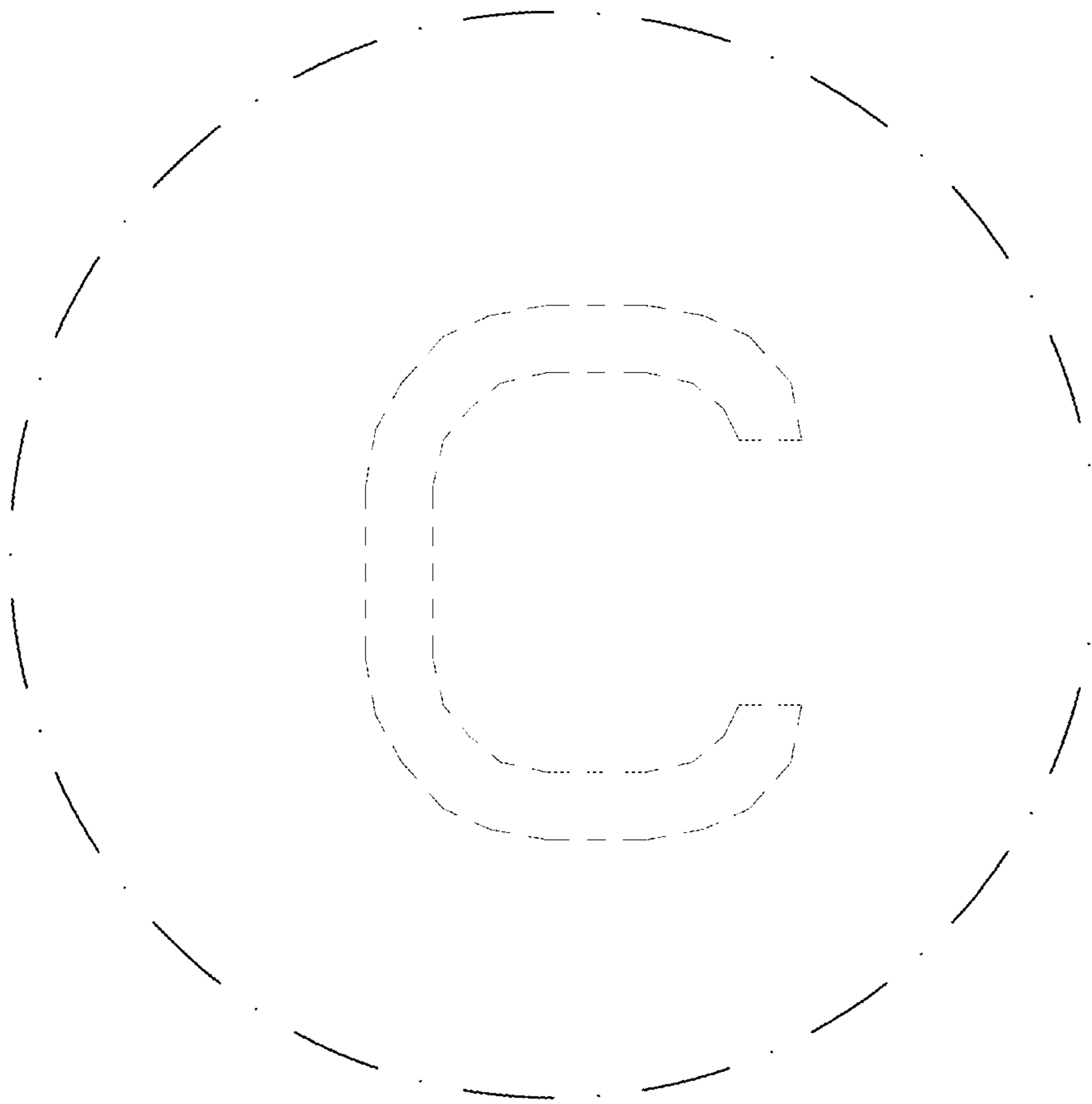

FIG.64

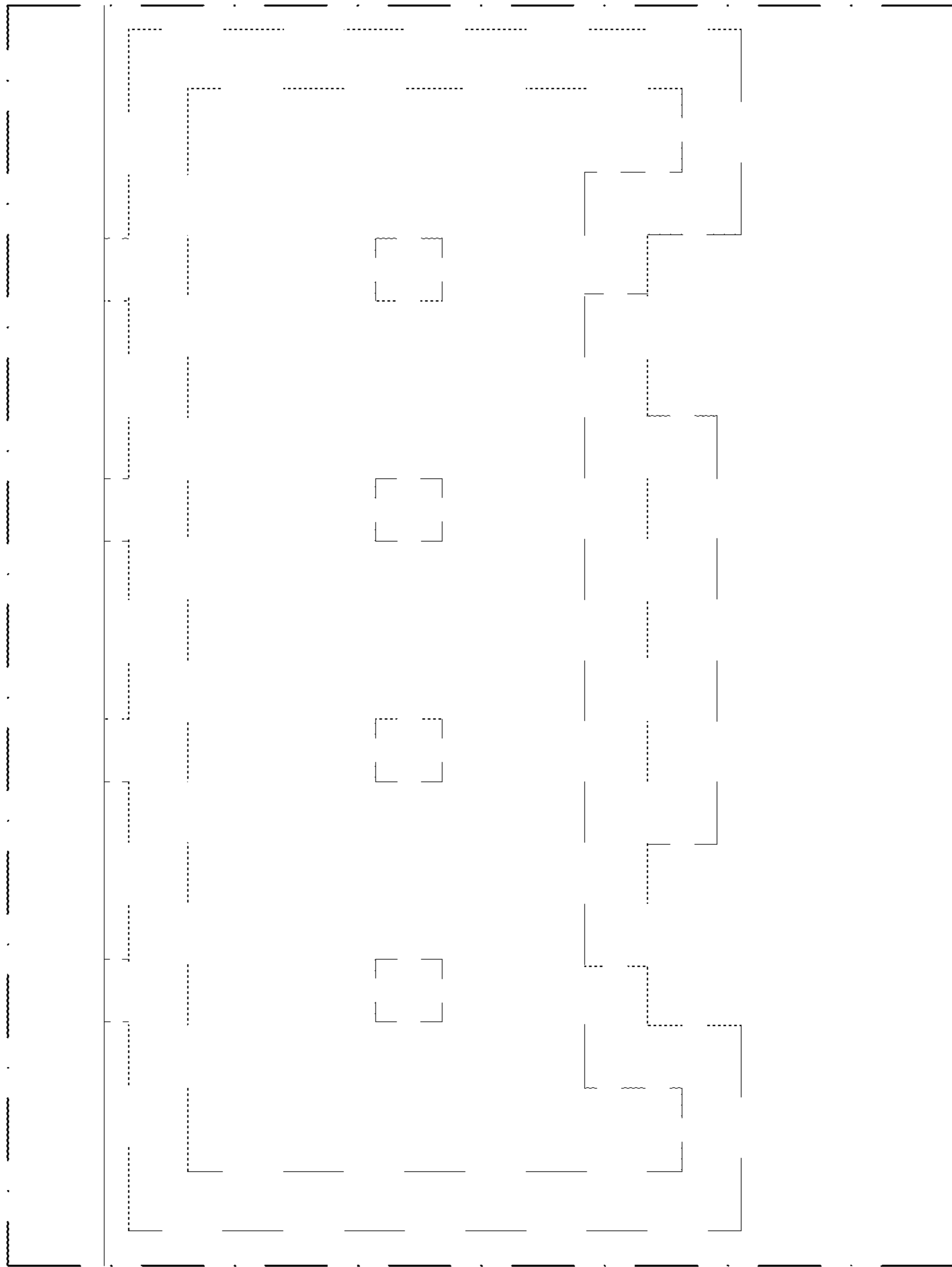

FIG. 65

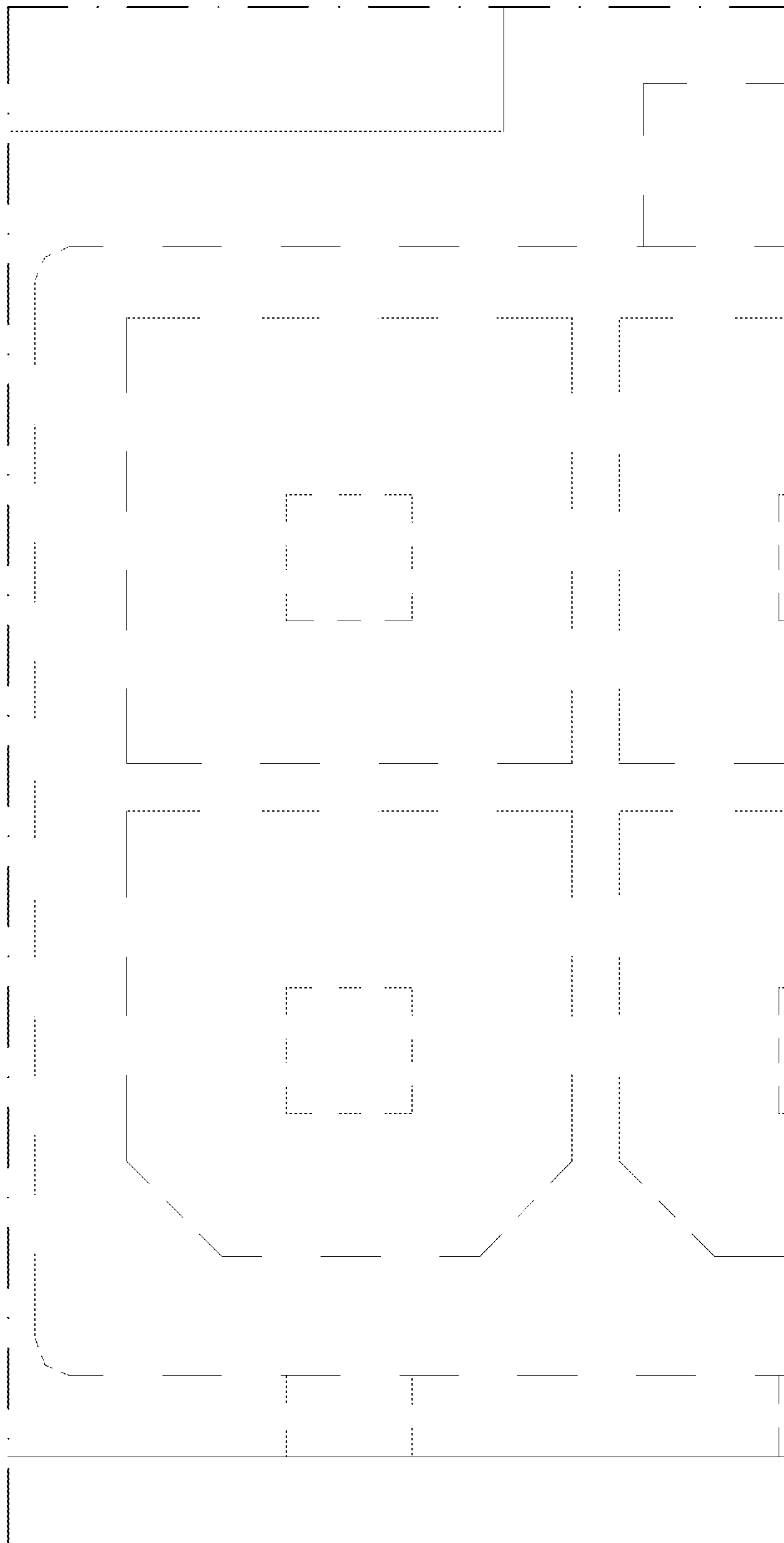

FIG. 66

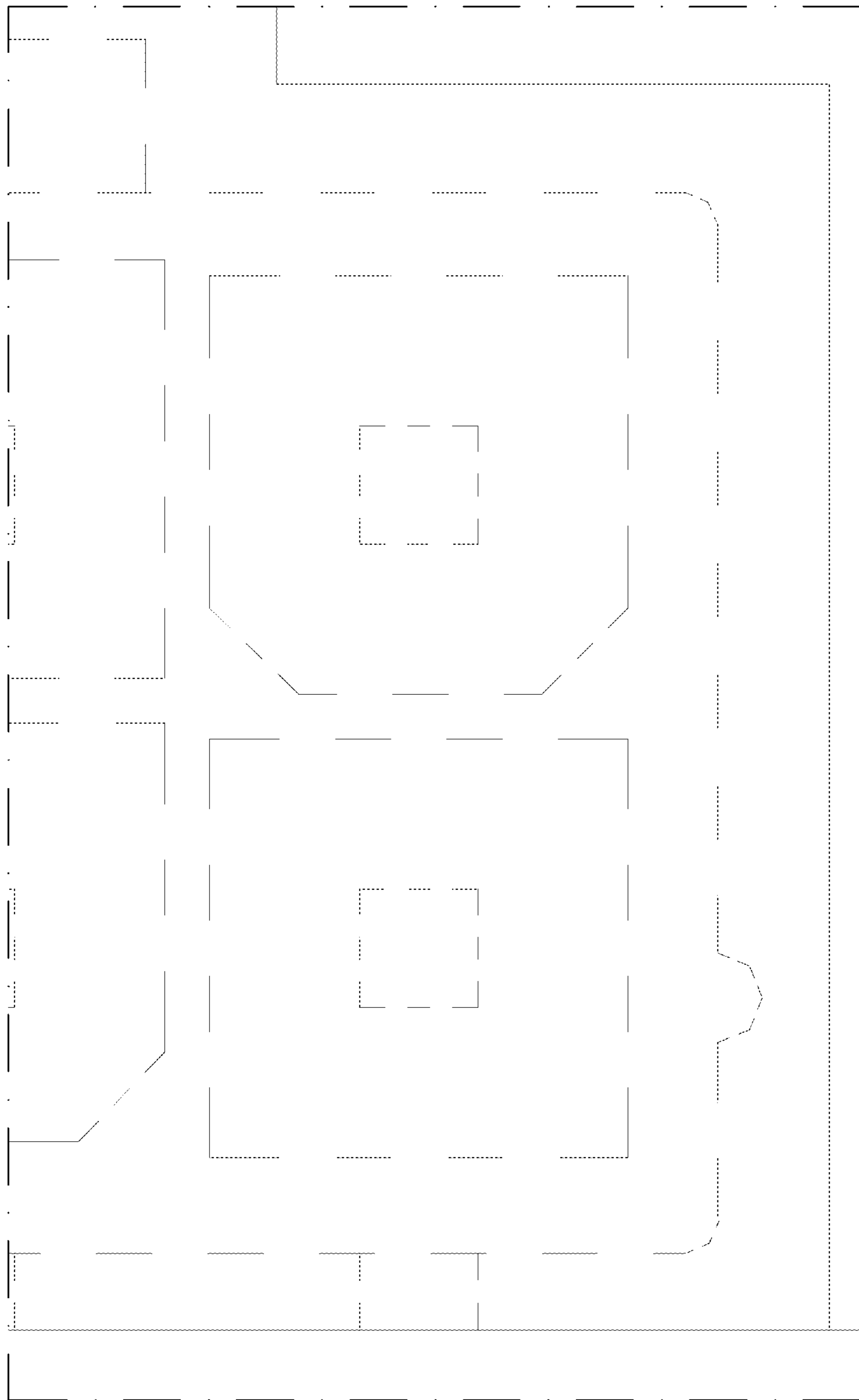

FIG. 67

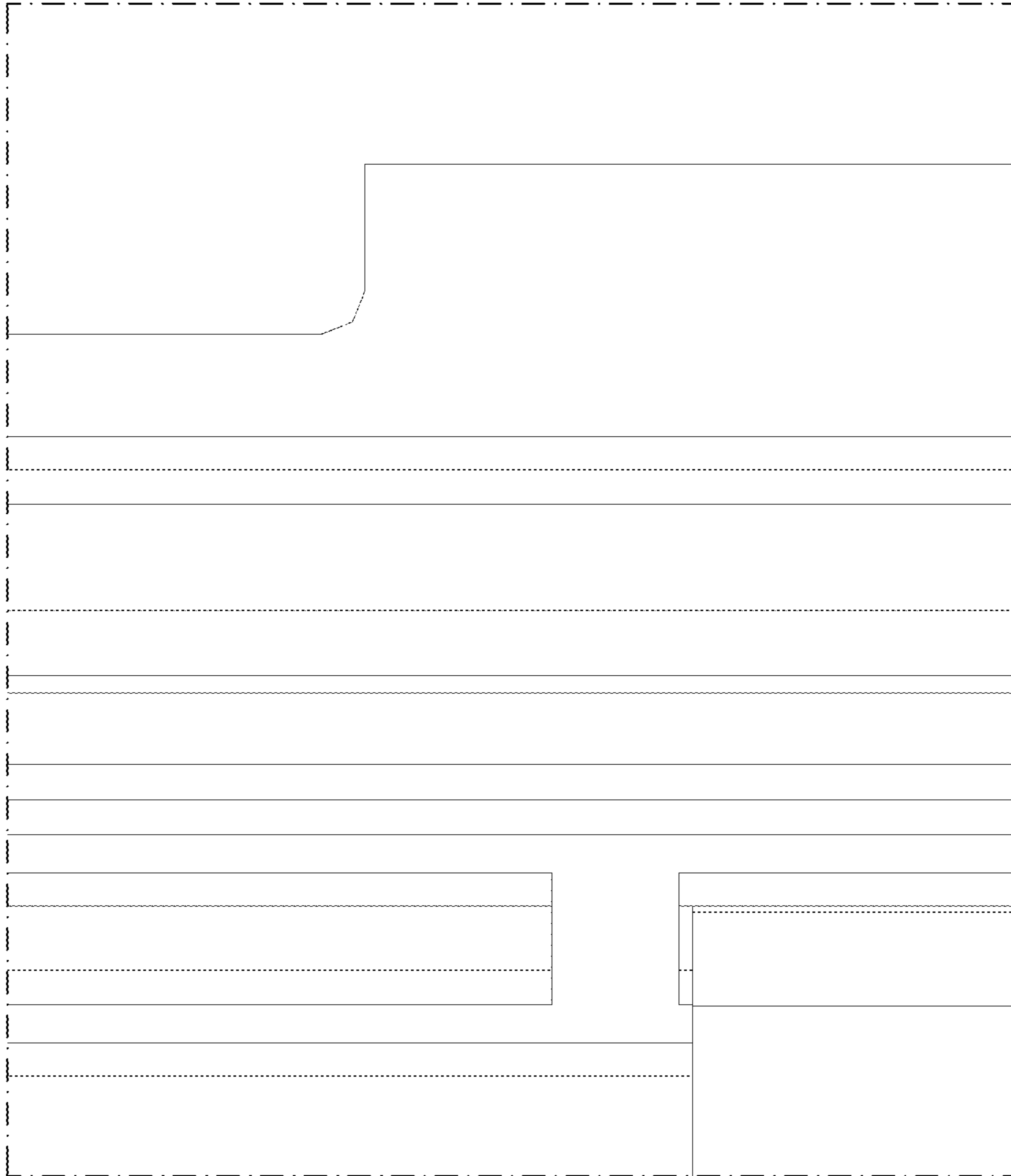

FIG. 68

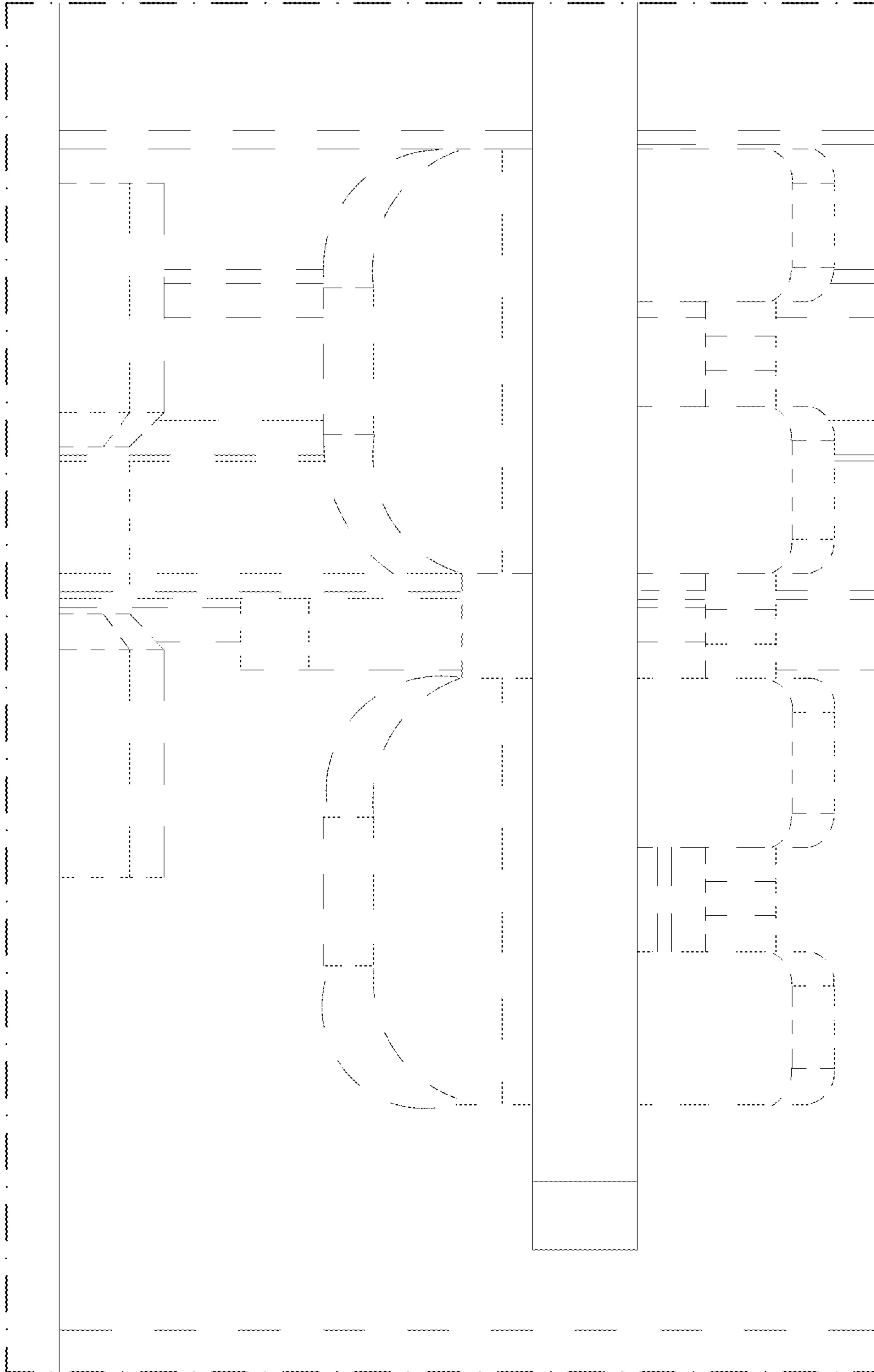

FIG.69

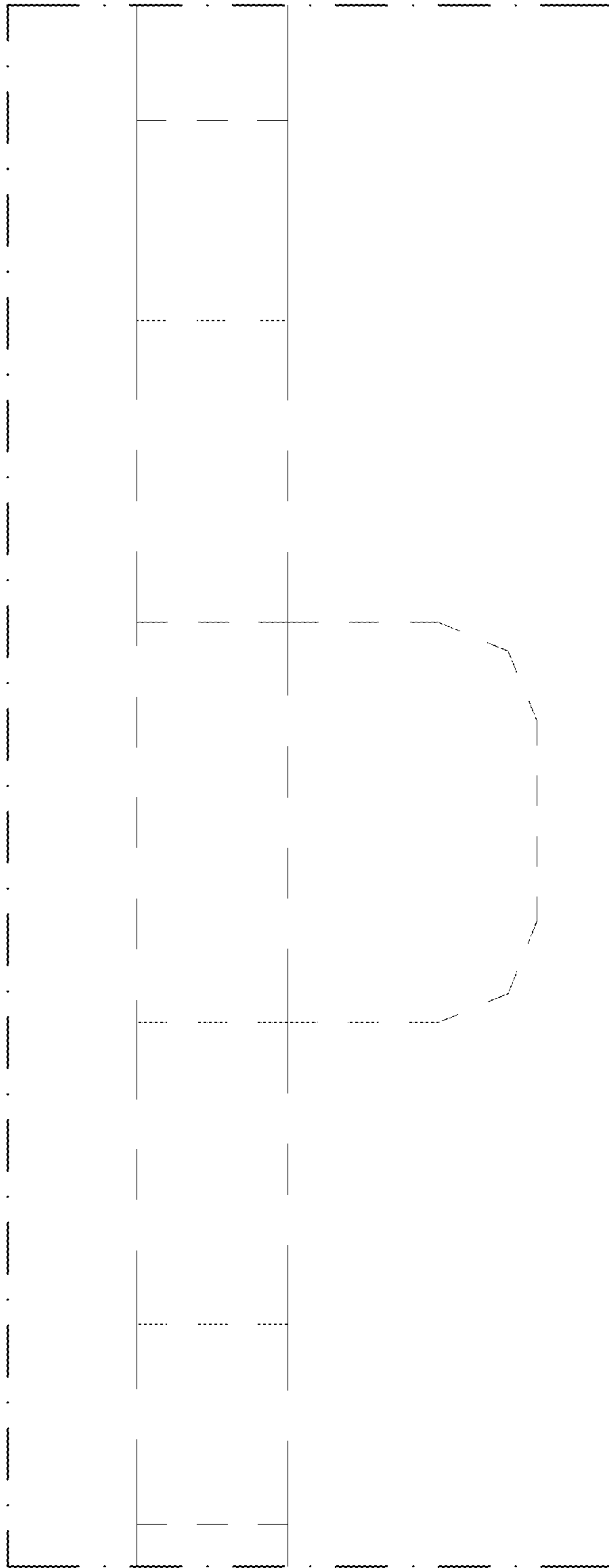

FIG.70

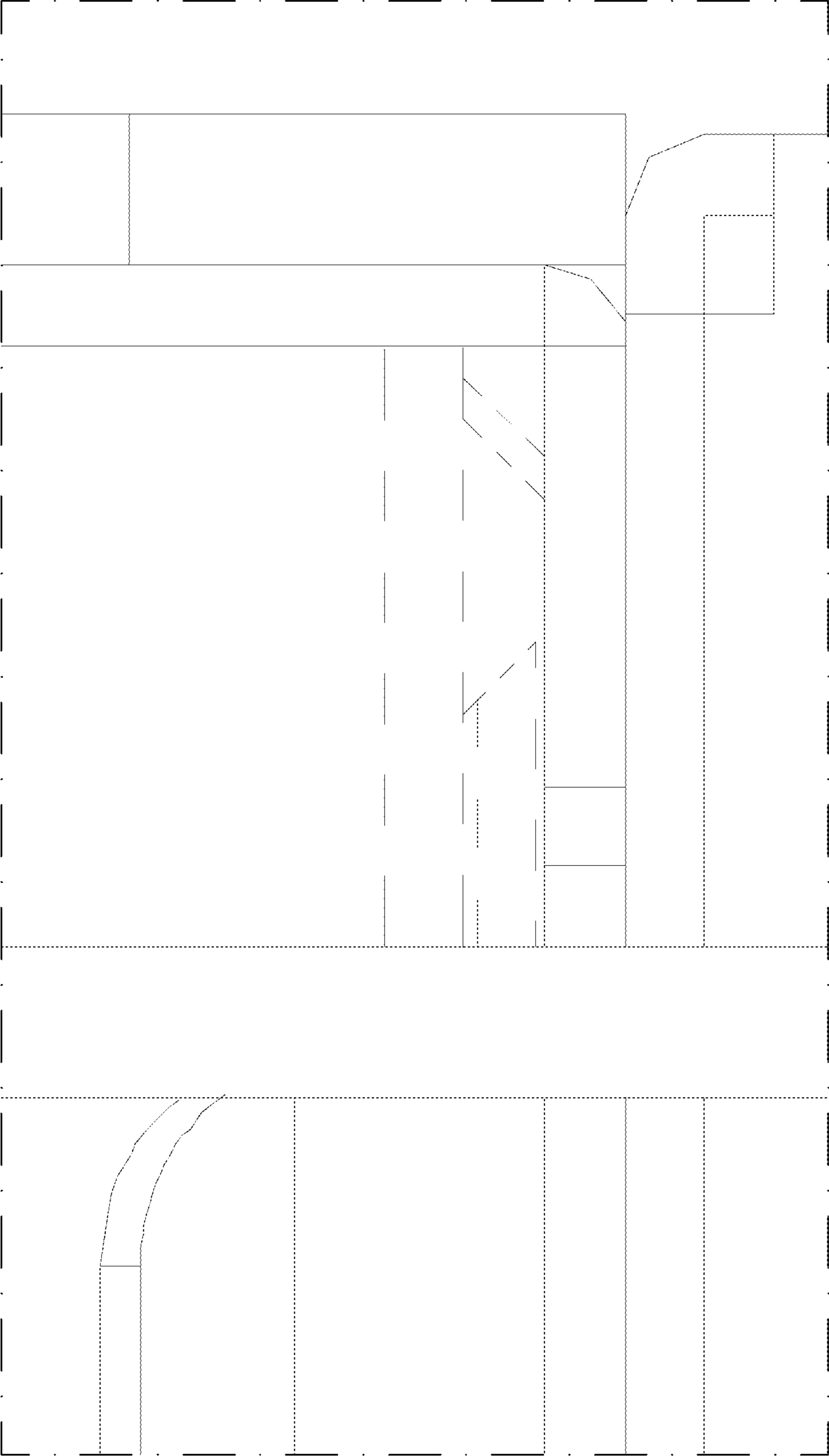

FIG. 71

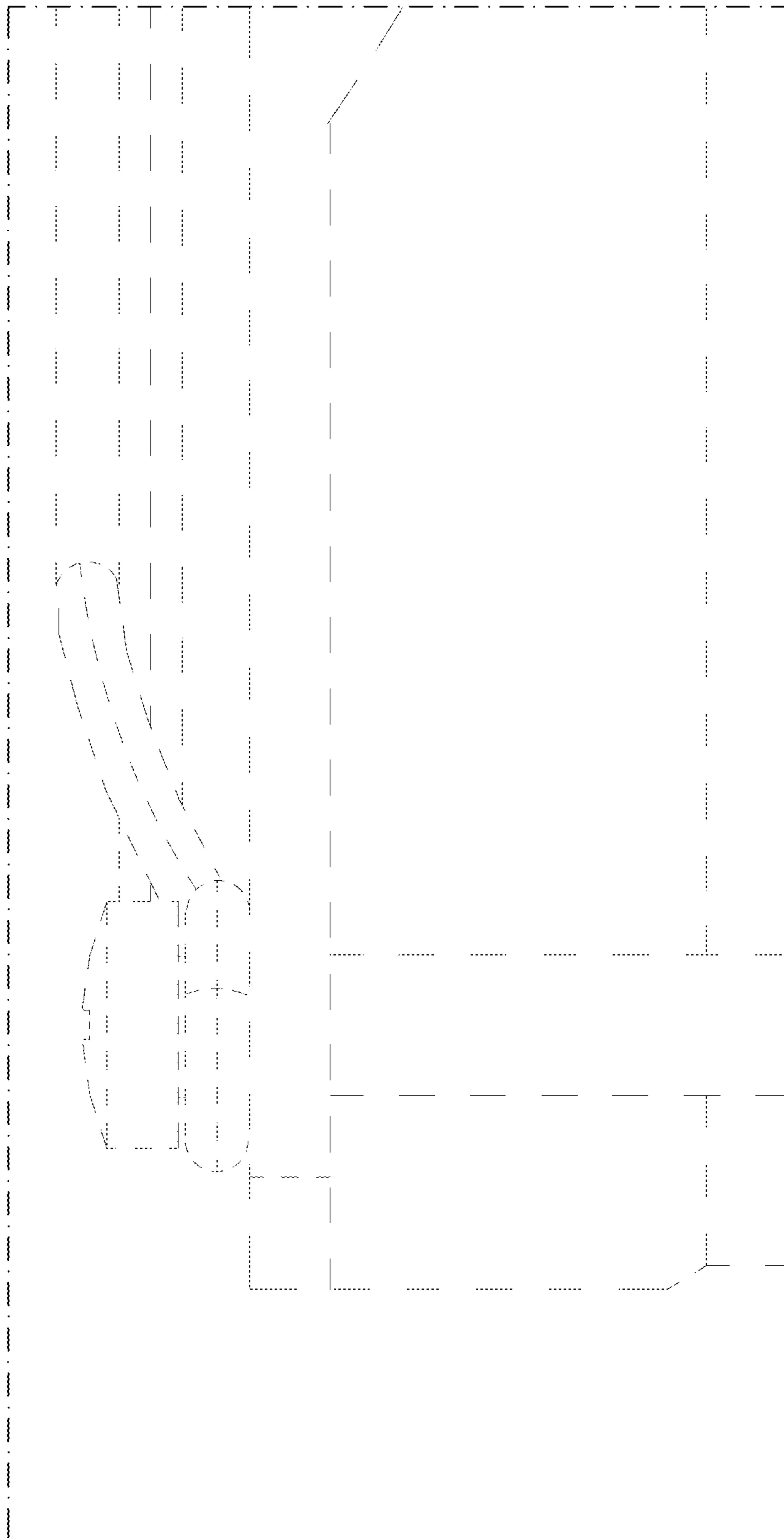

FIG. 72

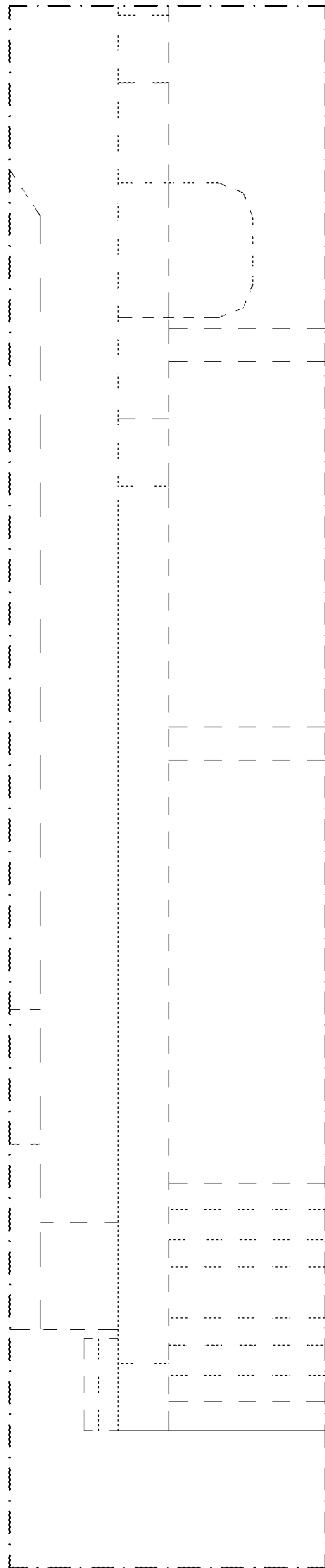

FIG. 73

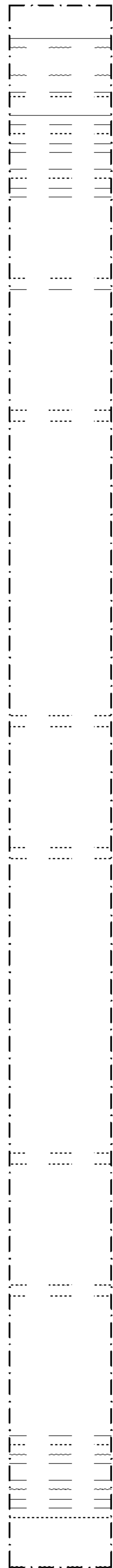

FIG. 74

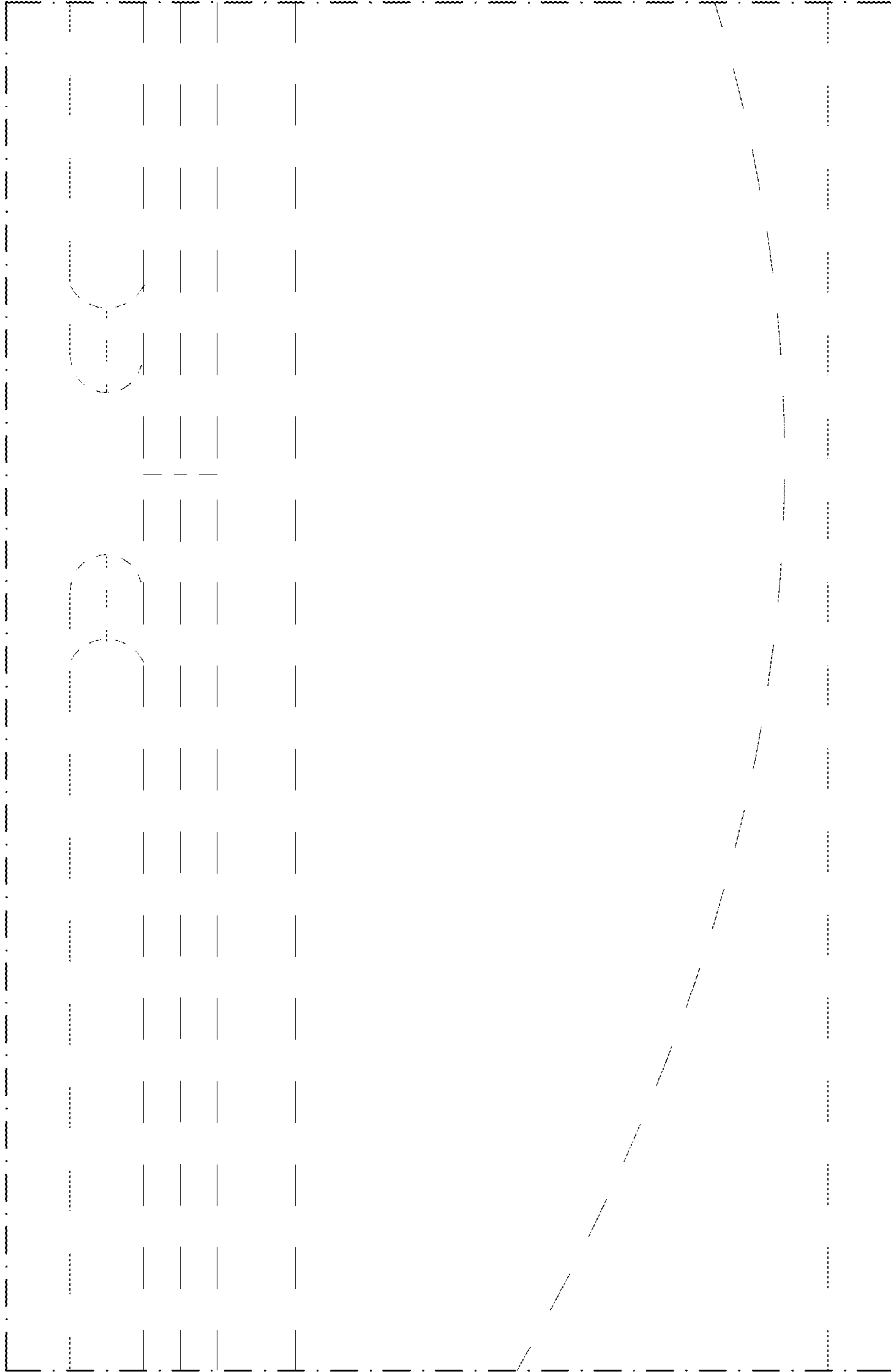

FIG. 75

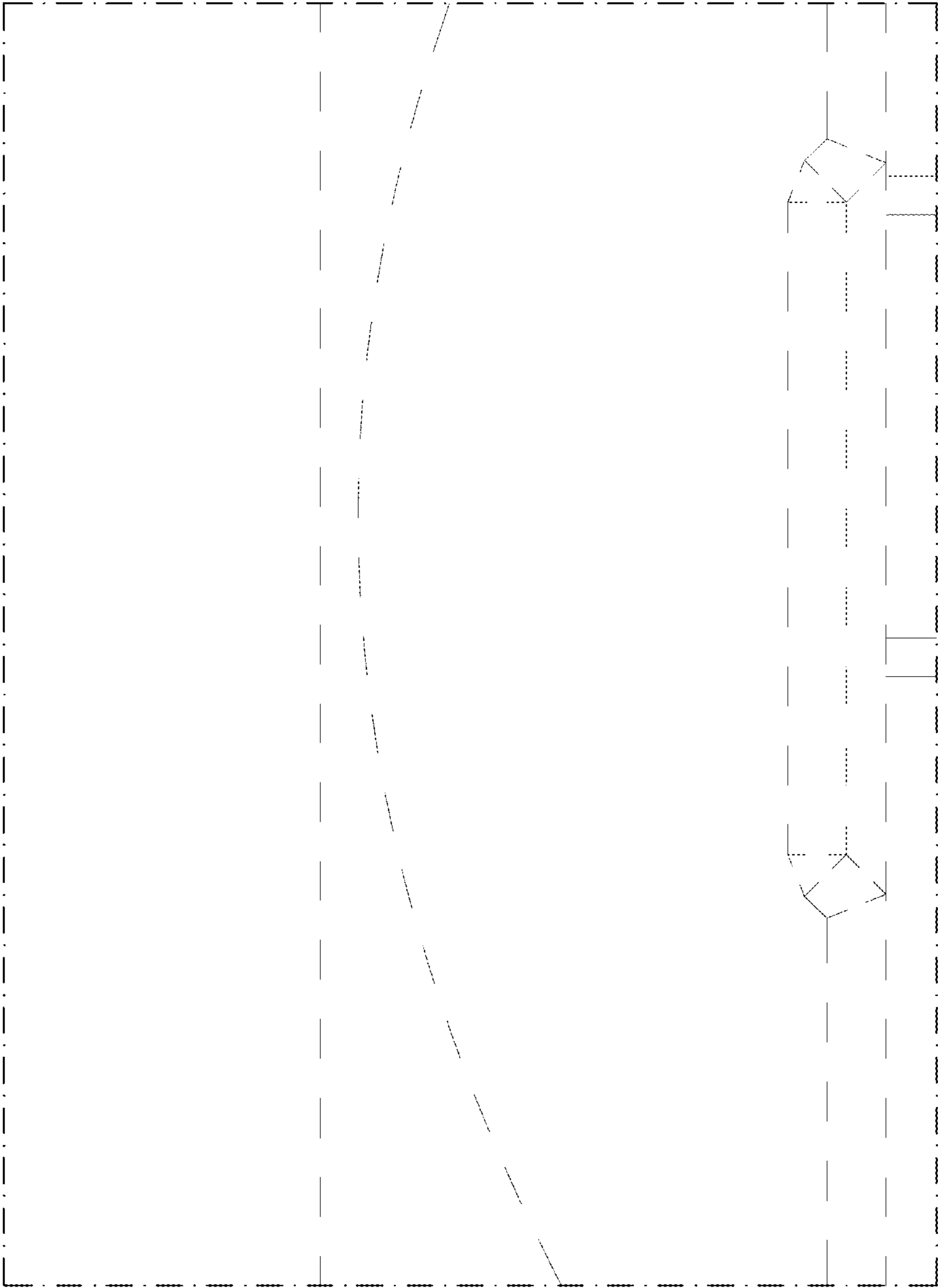

FIG.76

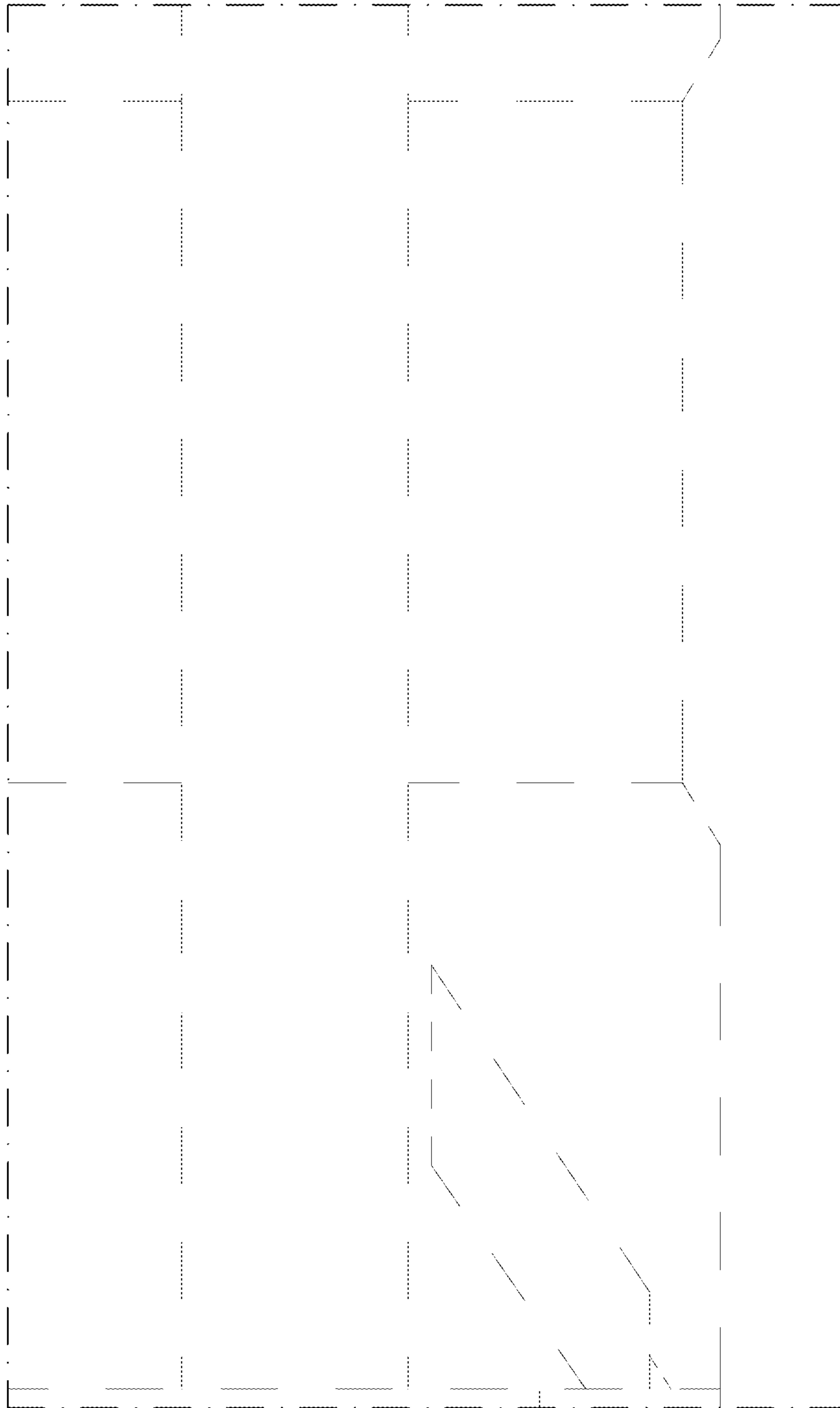

FIG. 77

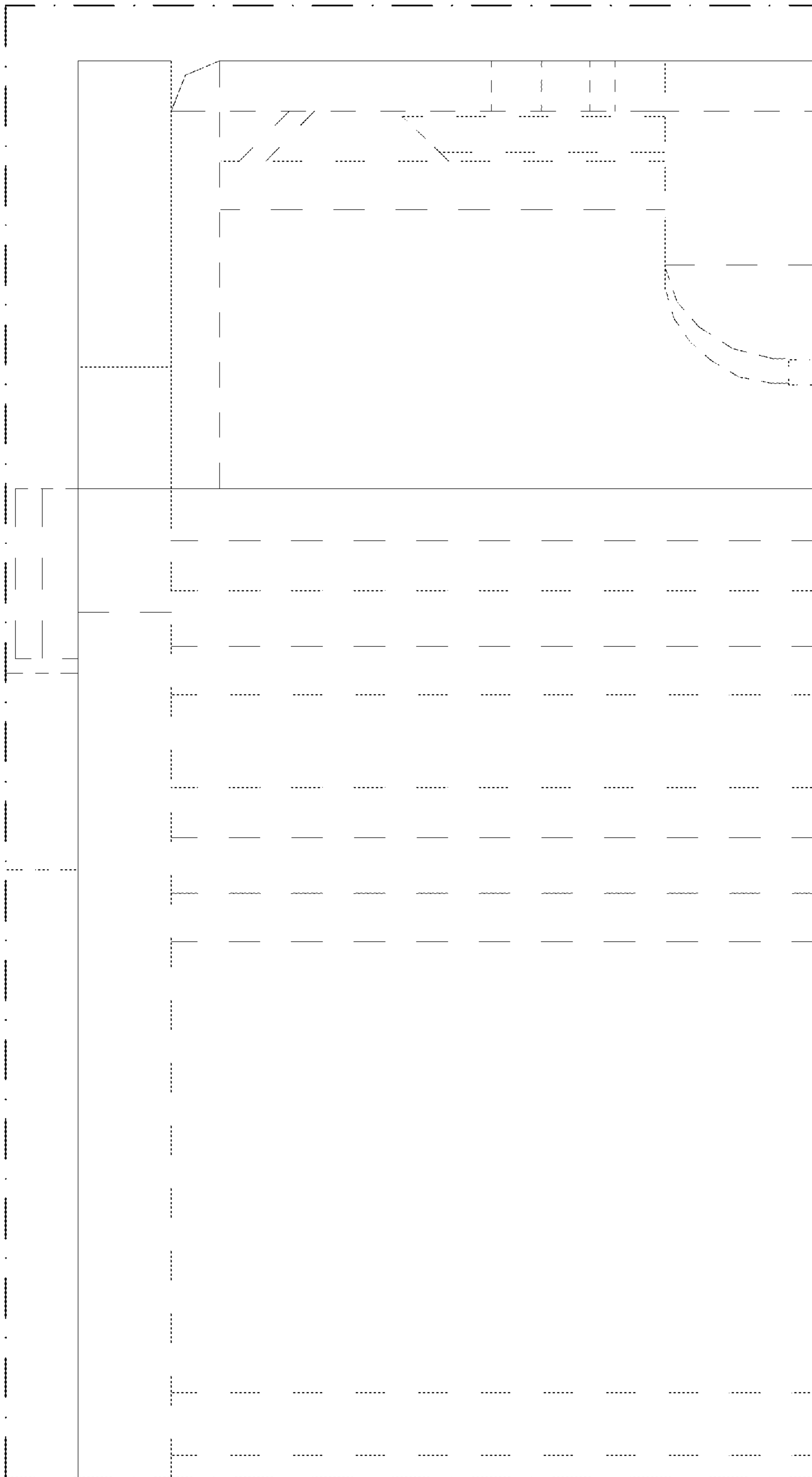

FIG. 78

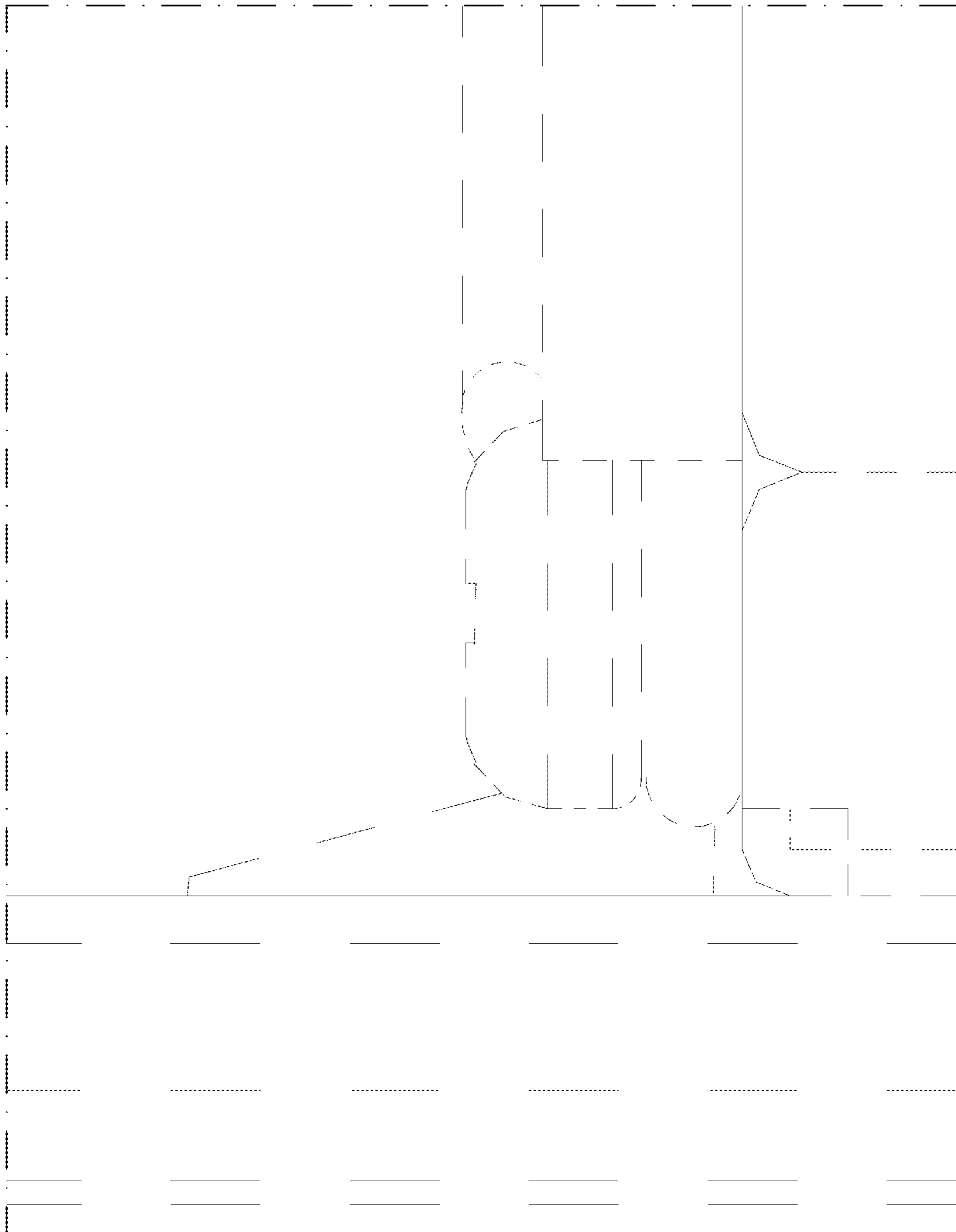

FIG. 79

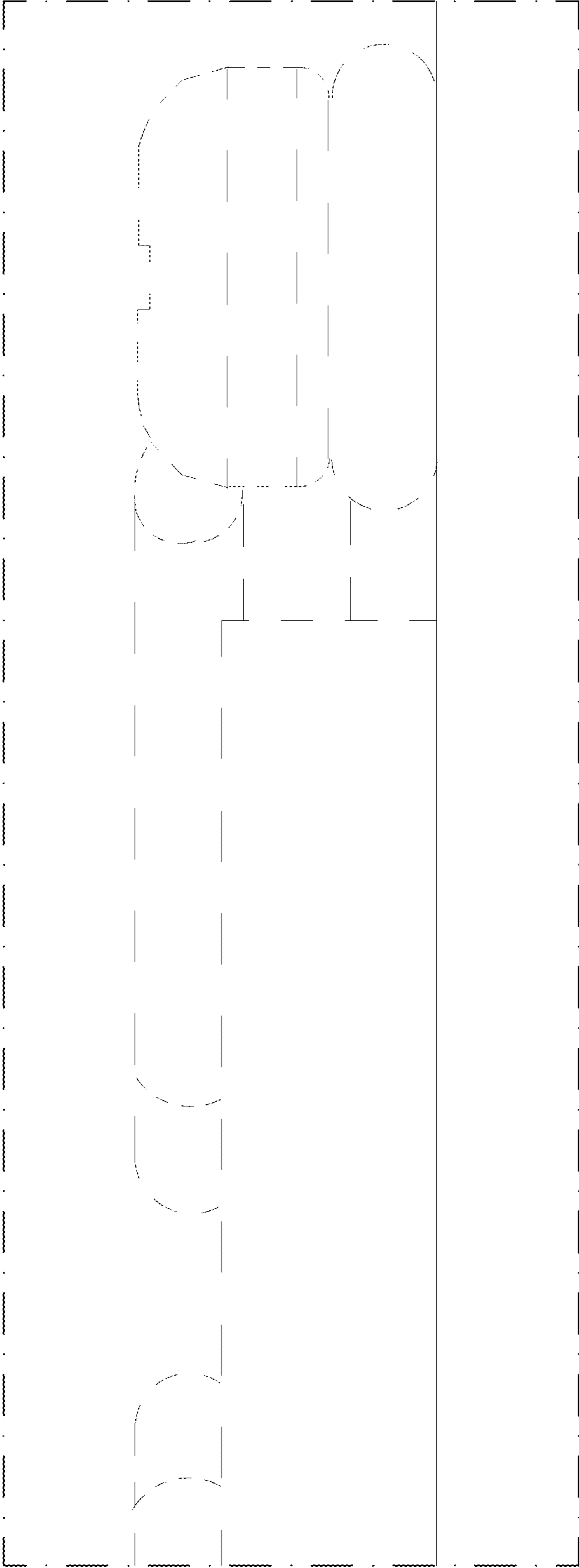

FIG. 80



FIG. 81

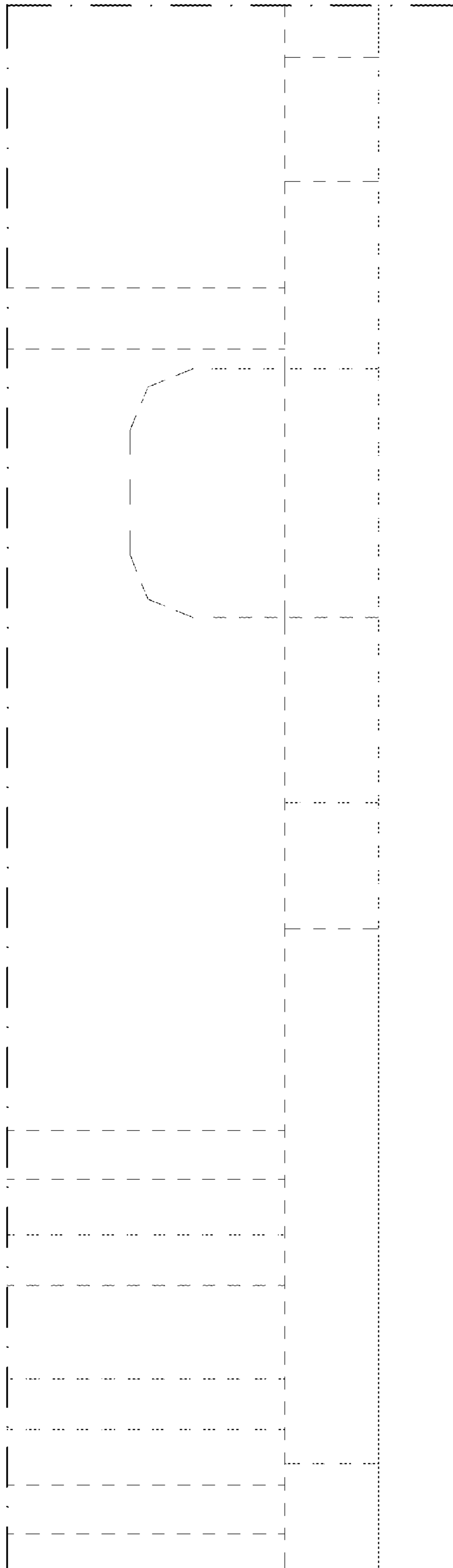

FIG. 82

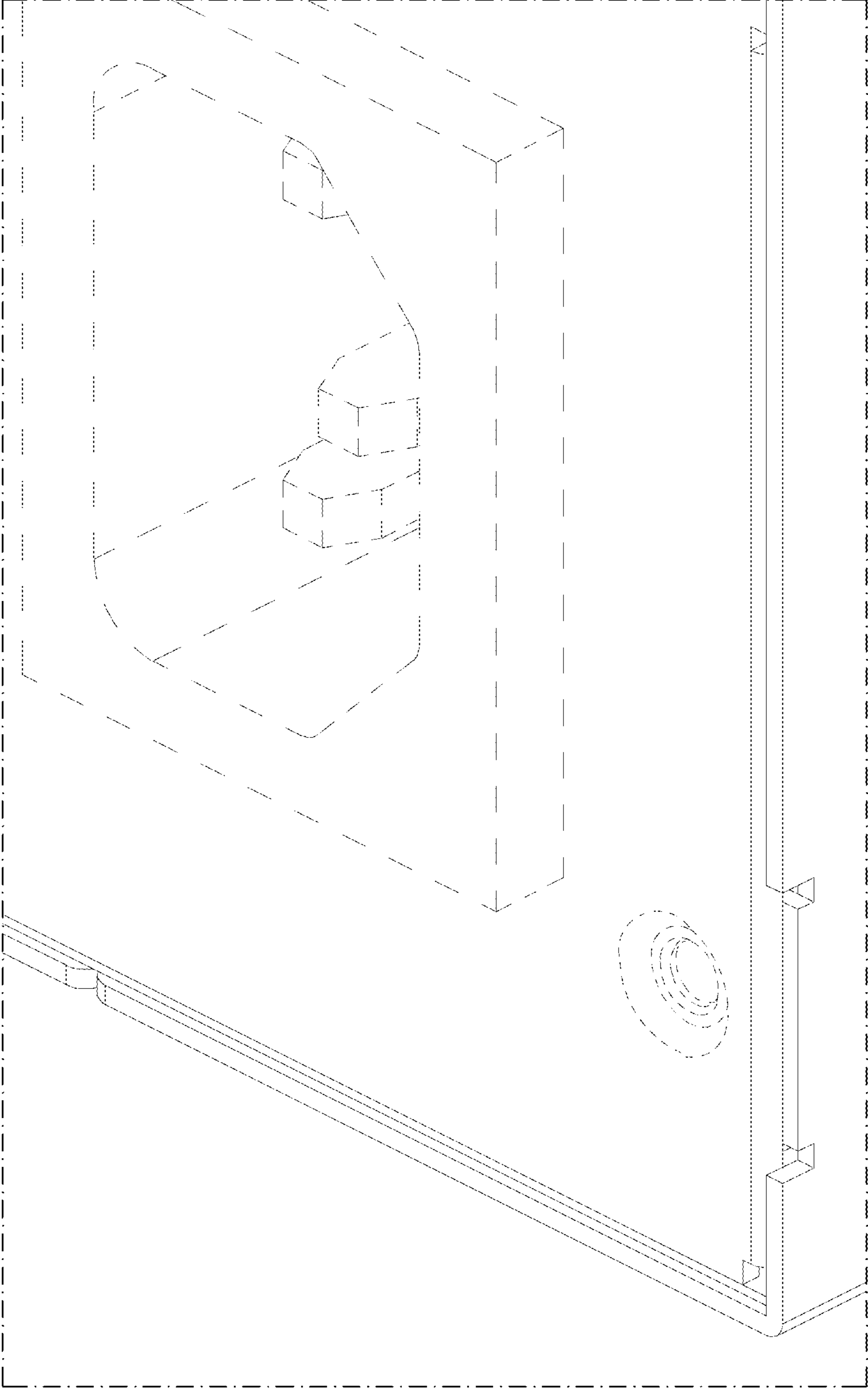

FIG. 83

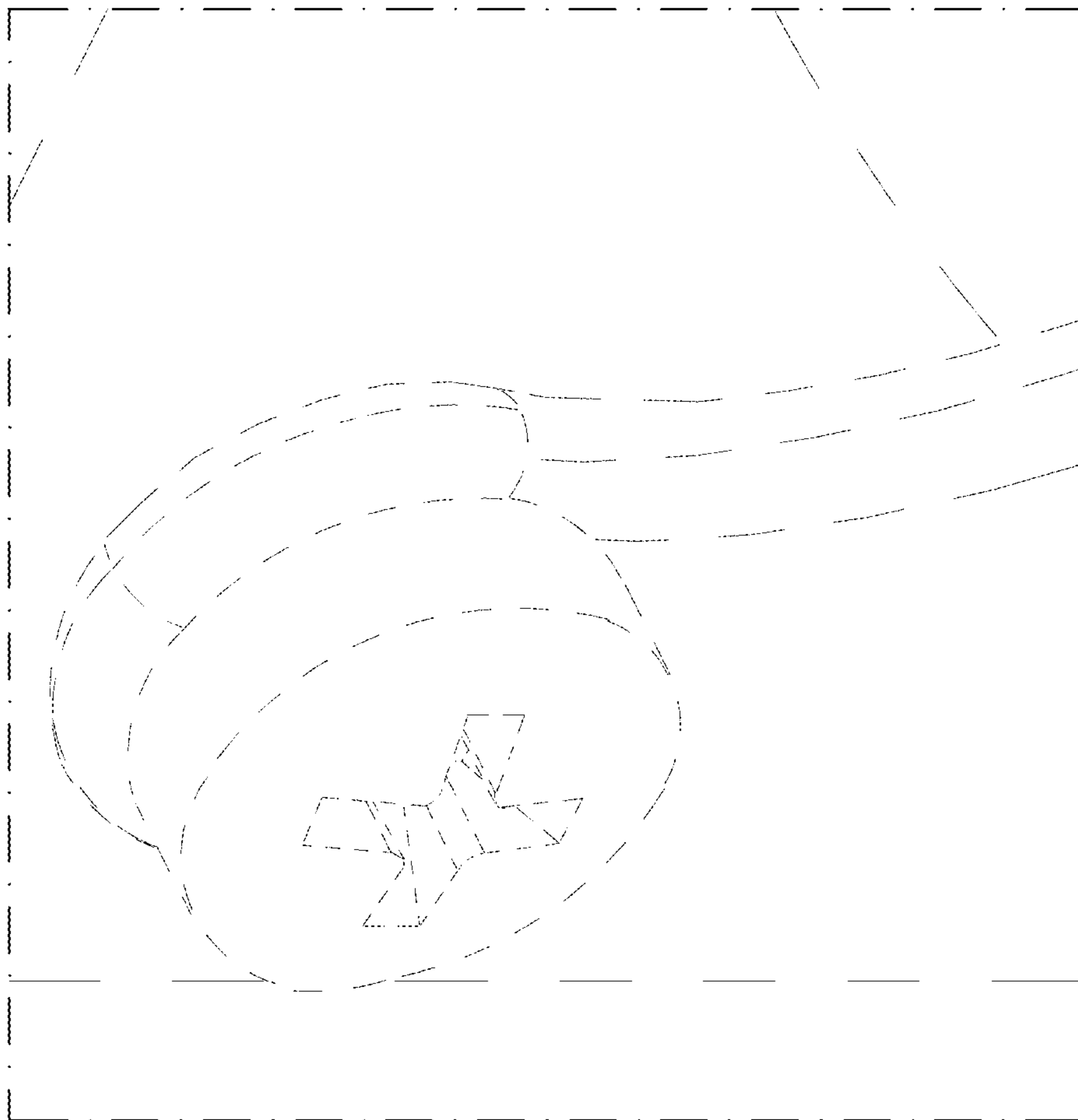

FIG. 84

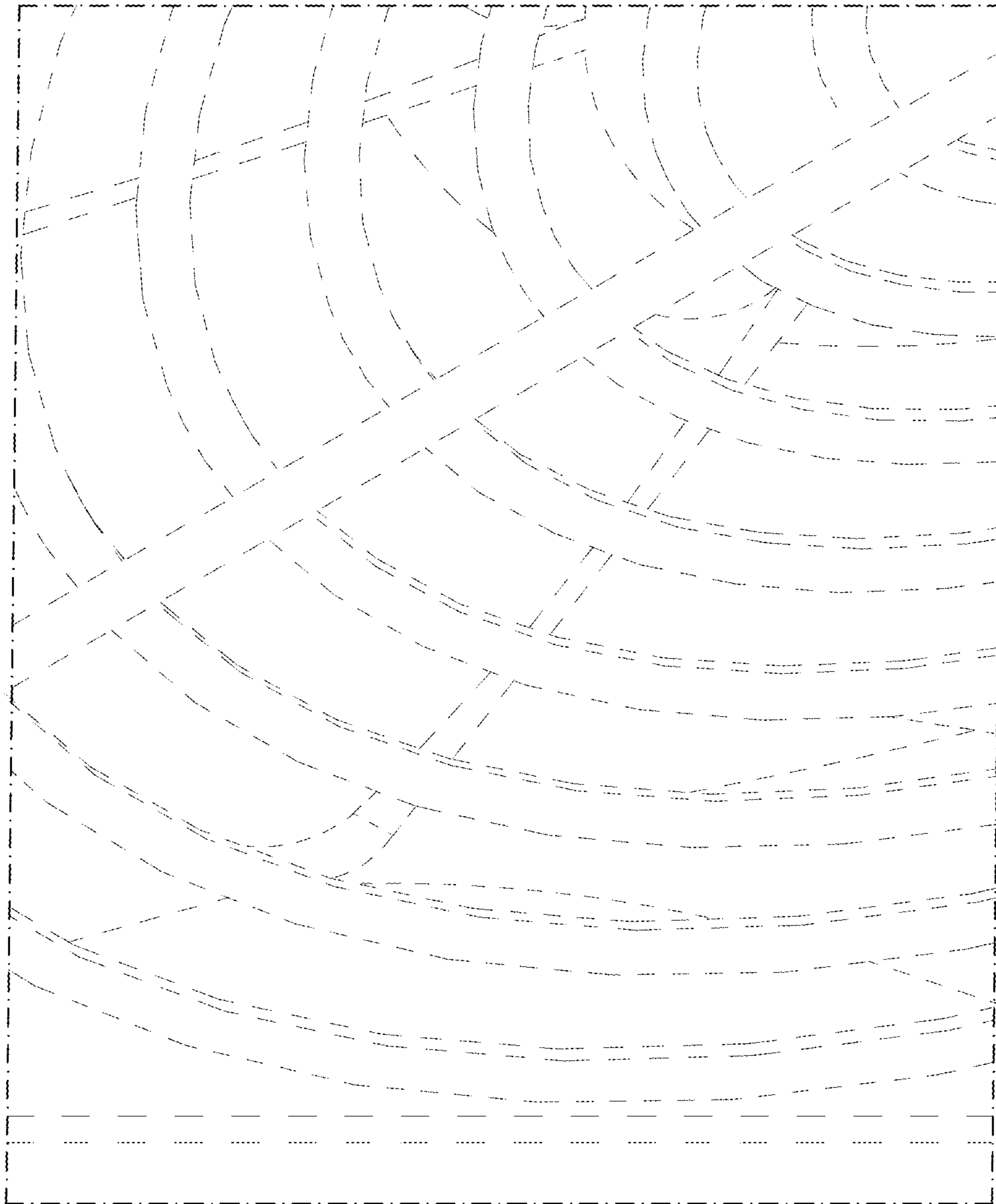

FIG. 85

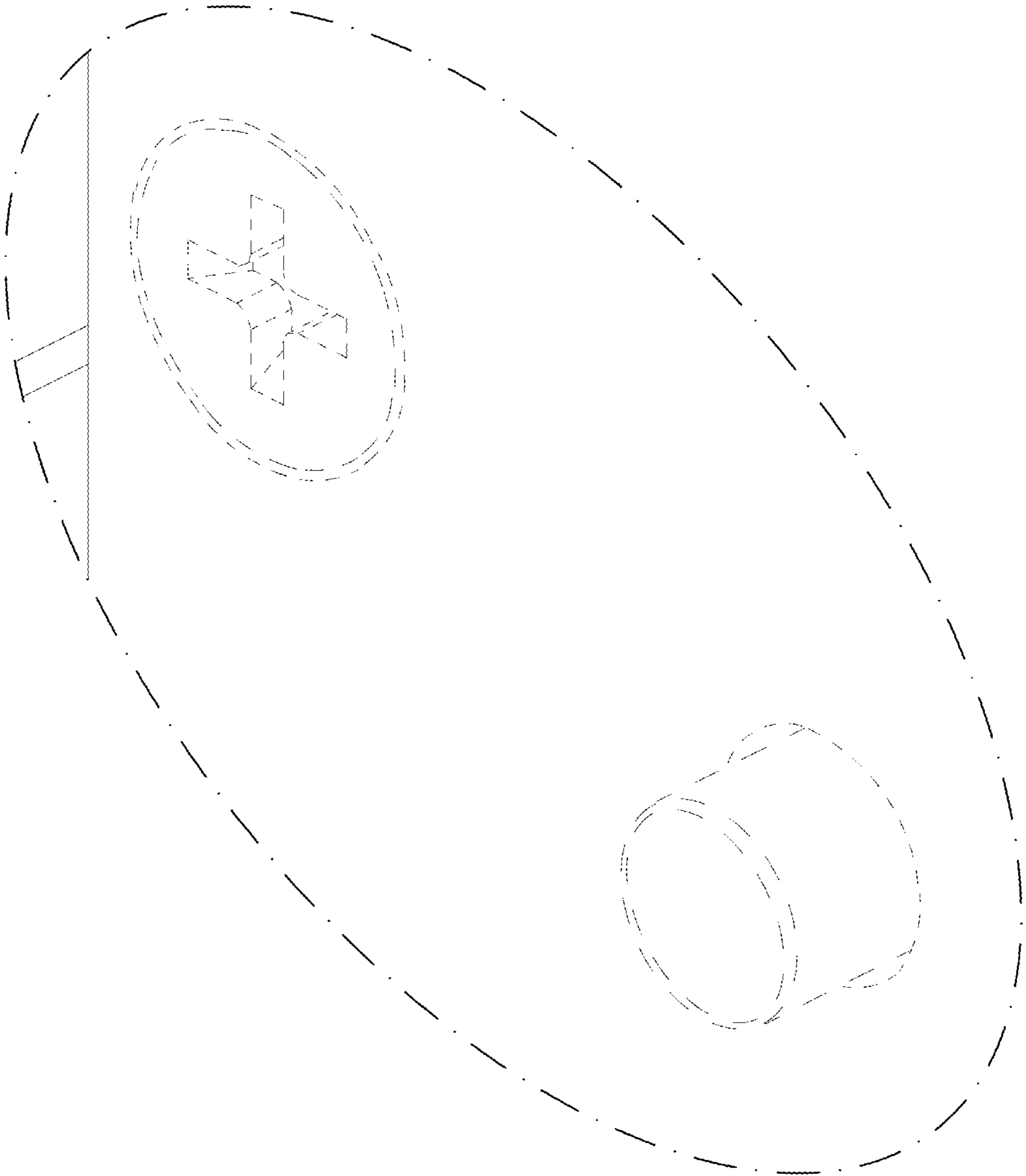

FIG. 86

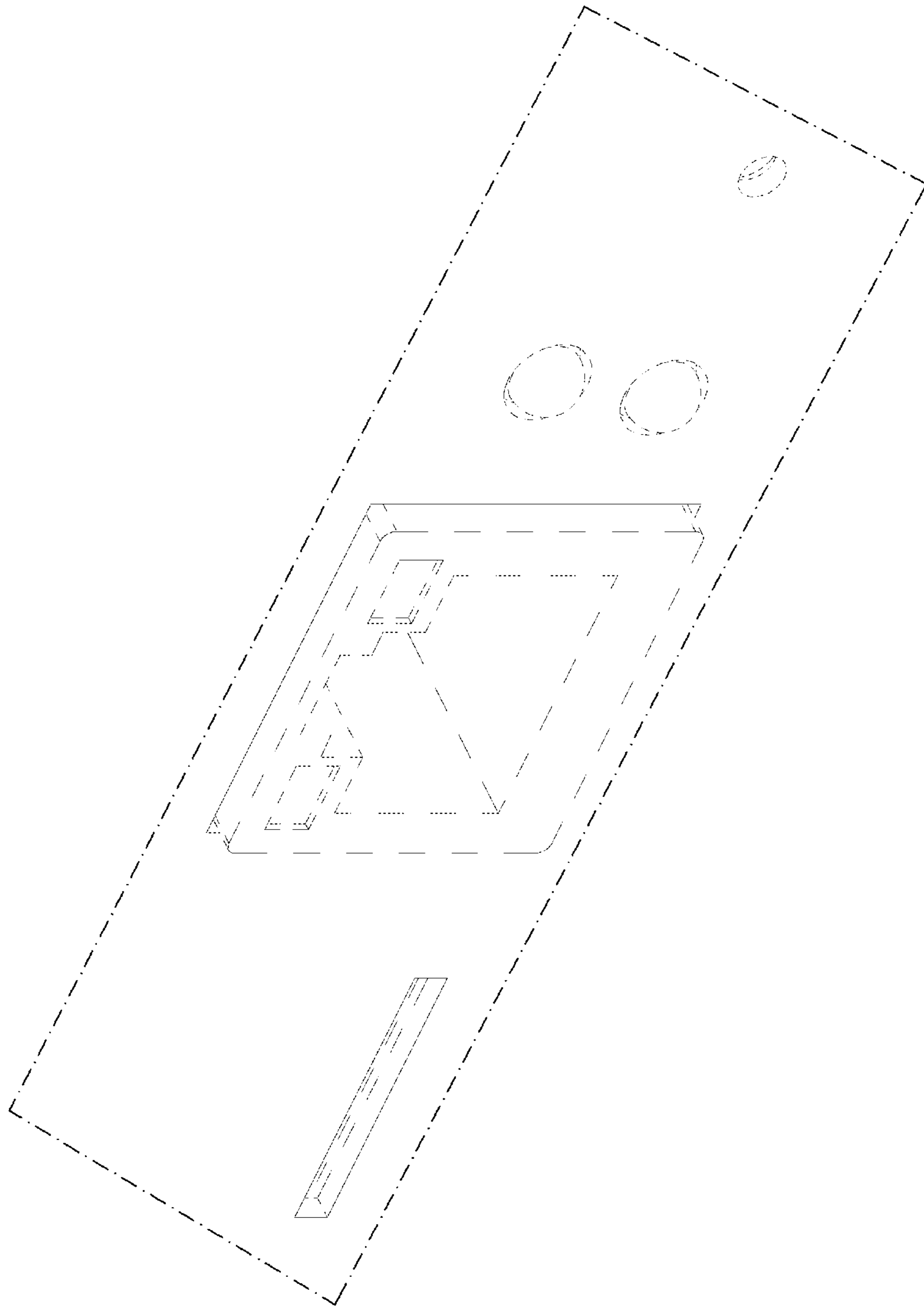

FIG. 87

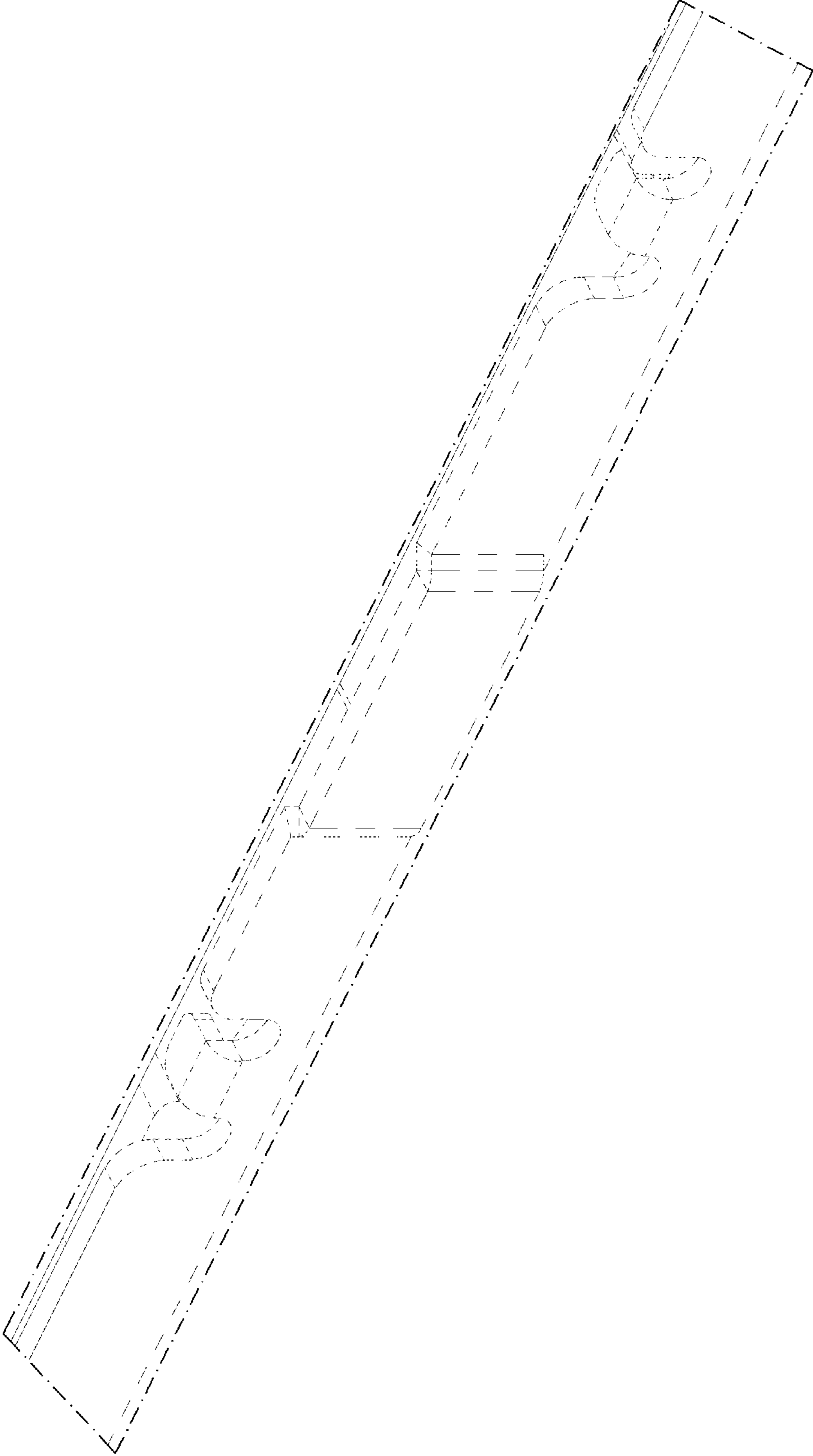

FIG.88

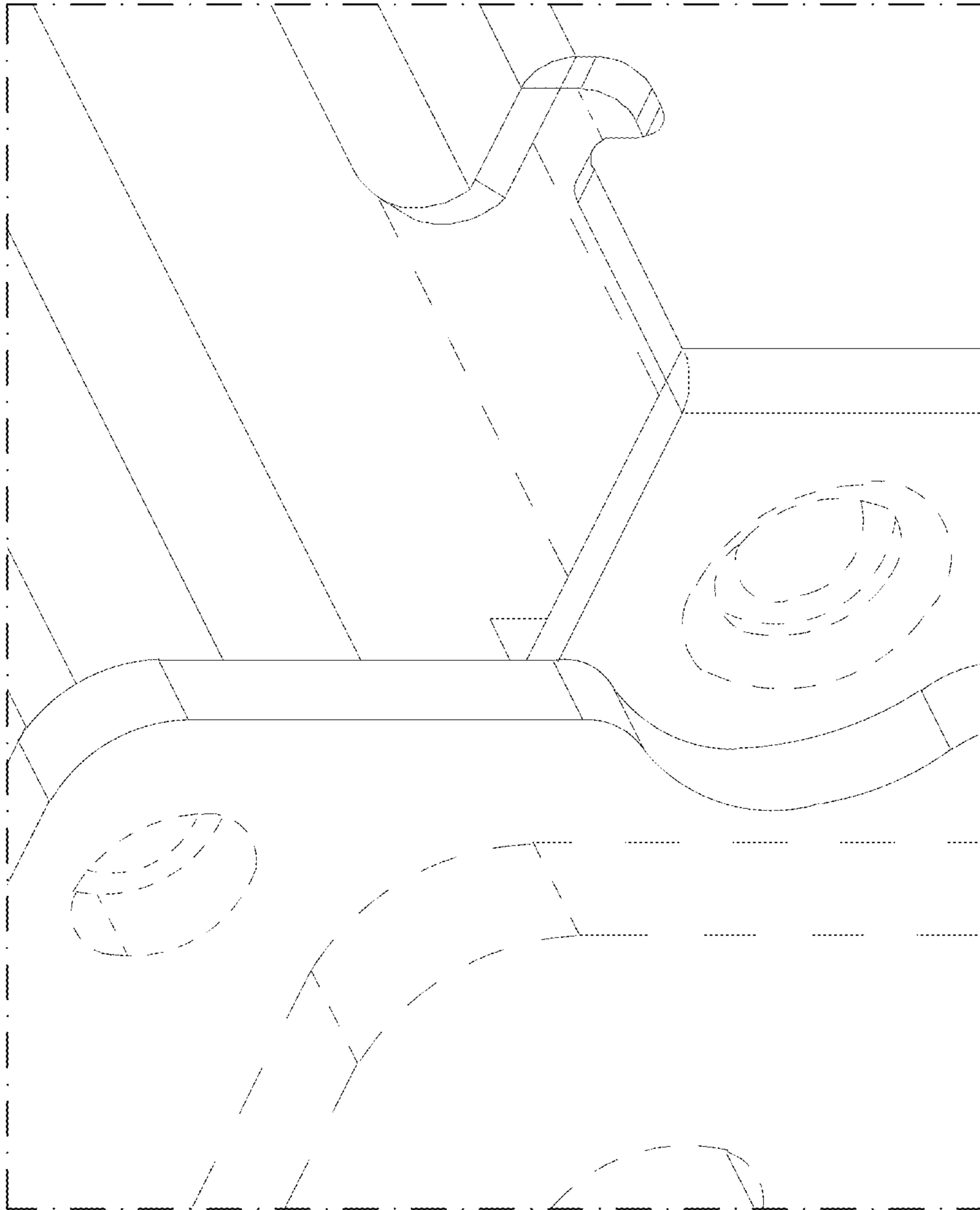

FIG. 89

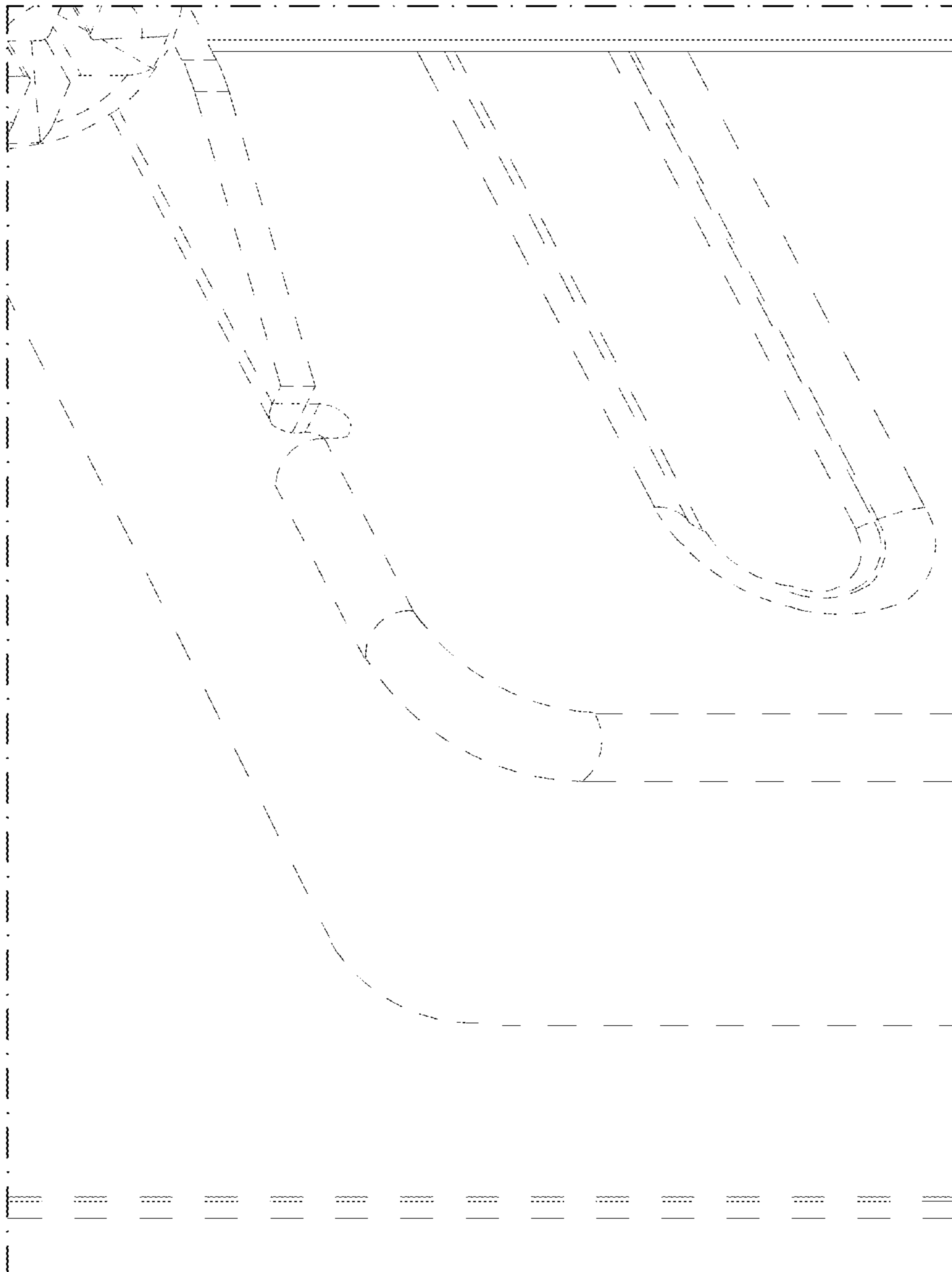

FIG.90

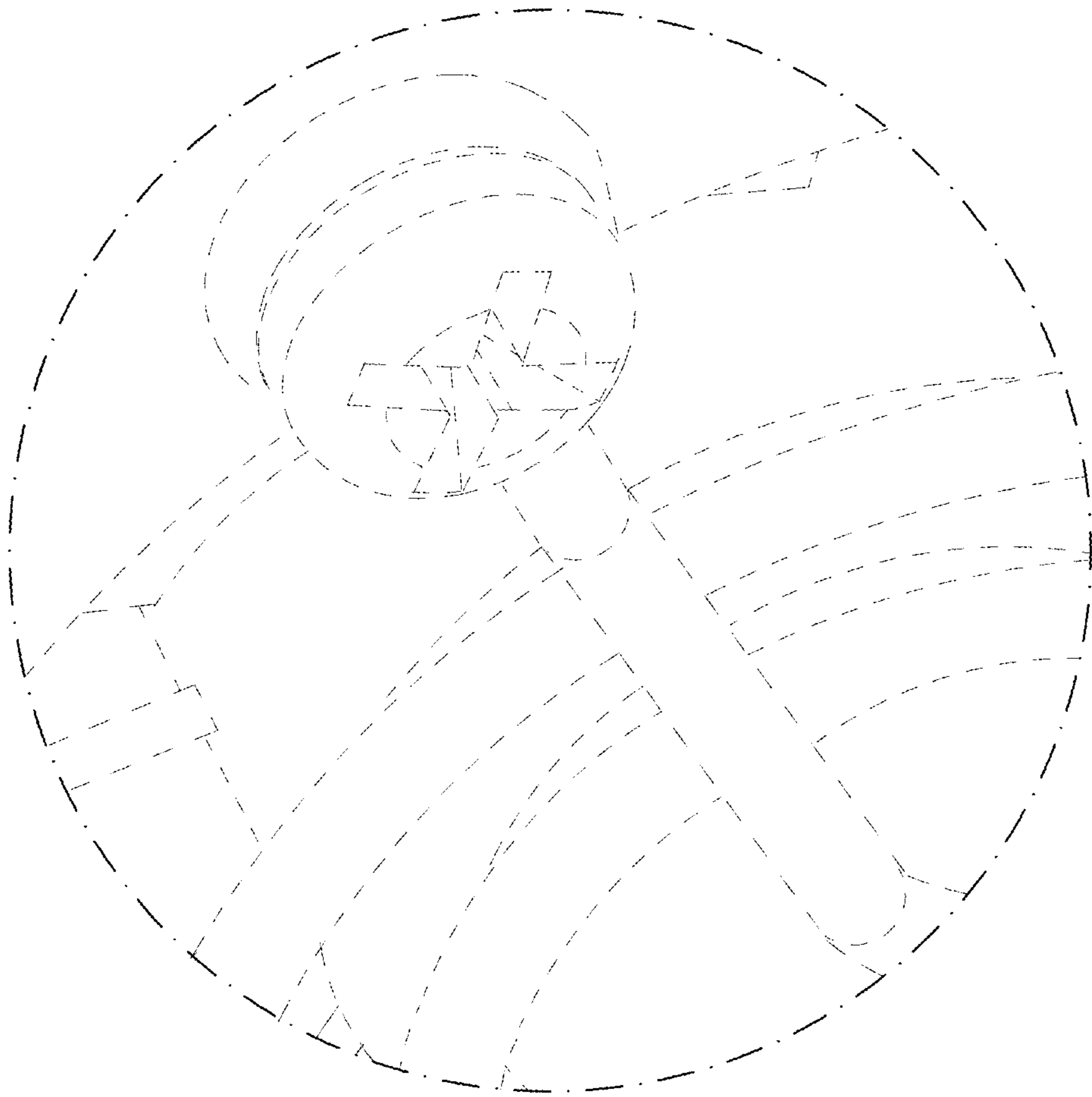

FIG. 91

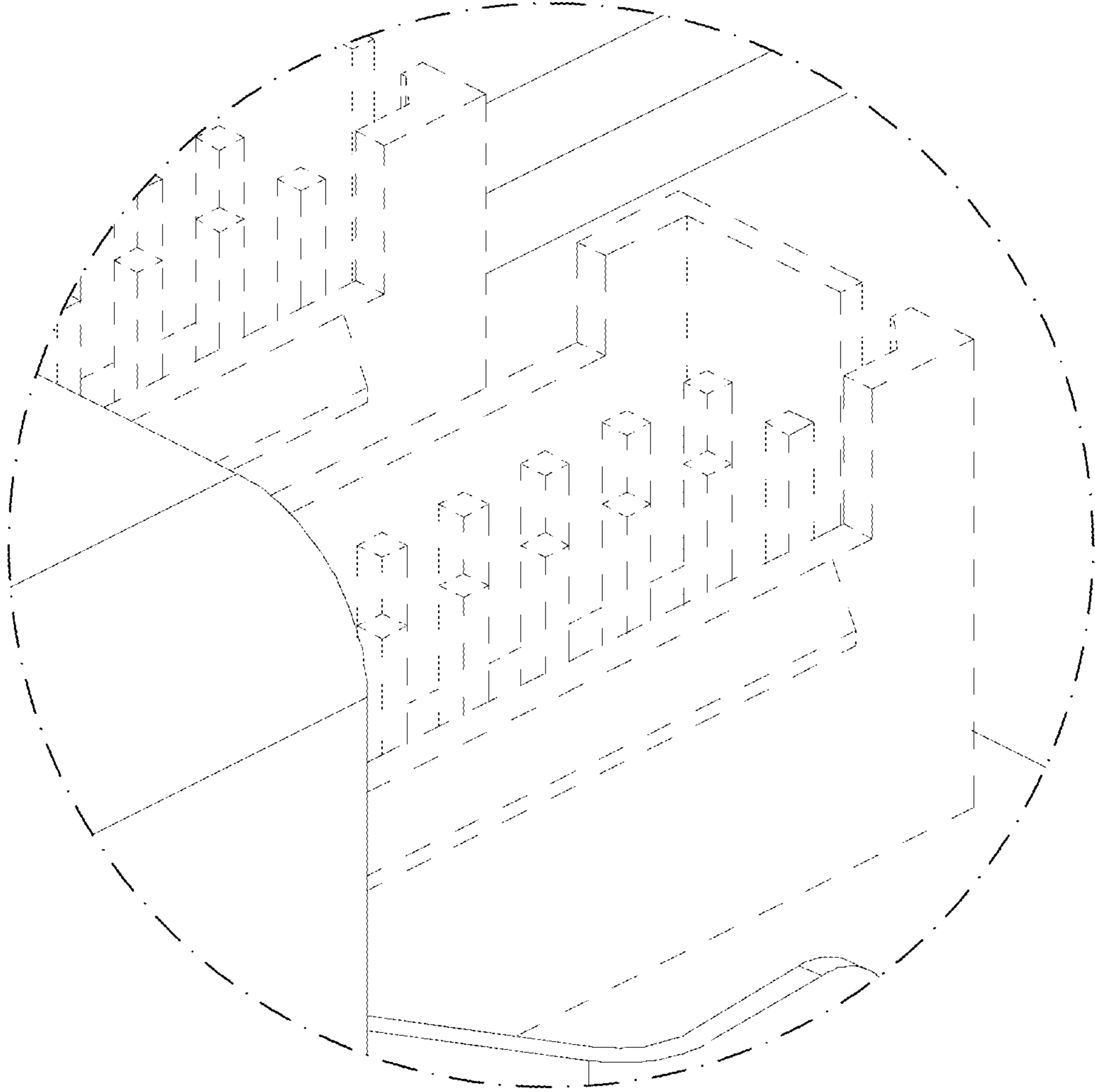

FIG. 92

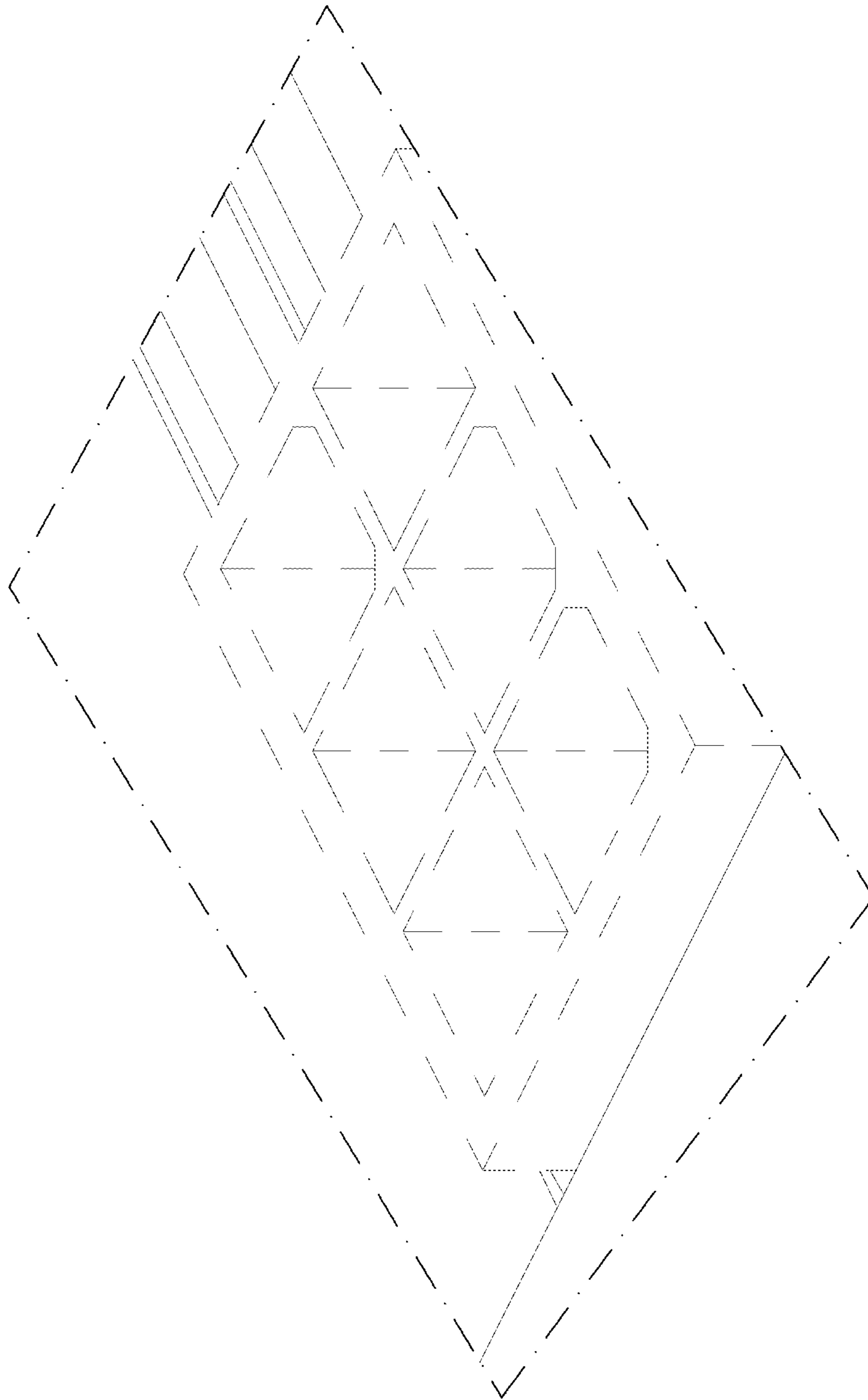

FIG. 93

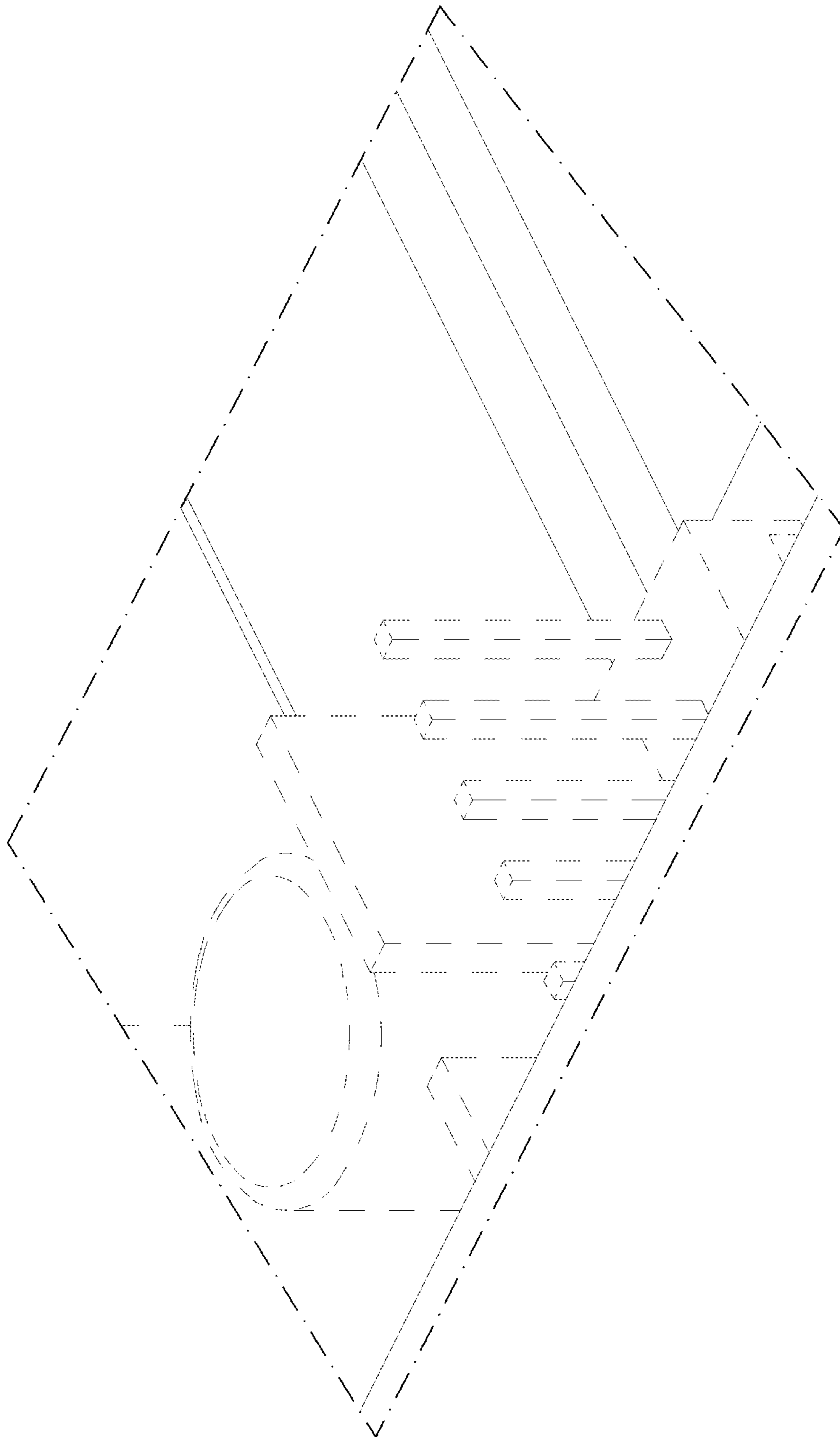

FIG.94

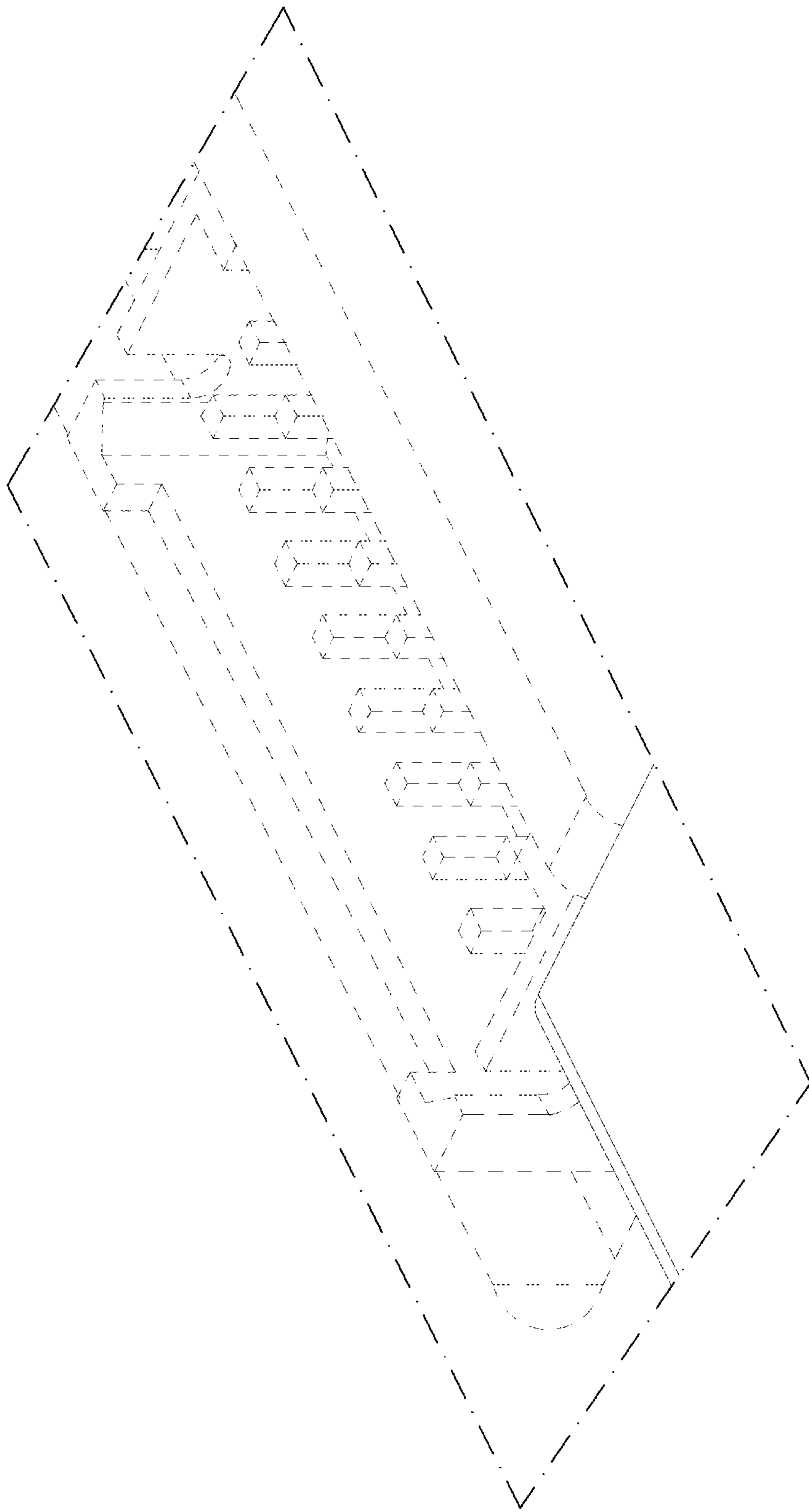

FIG.95

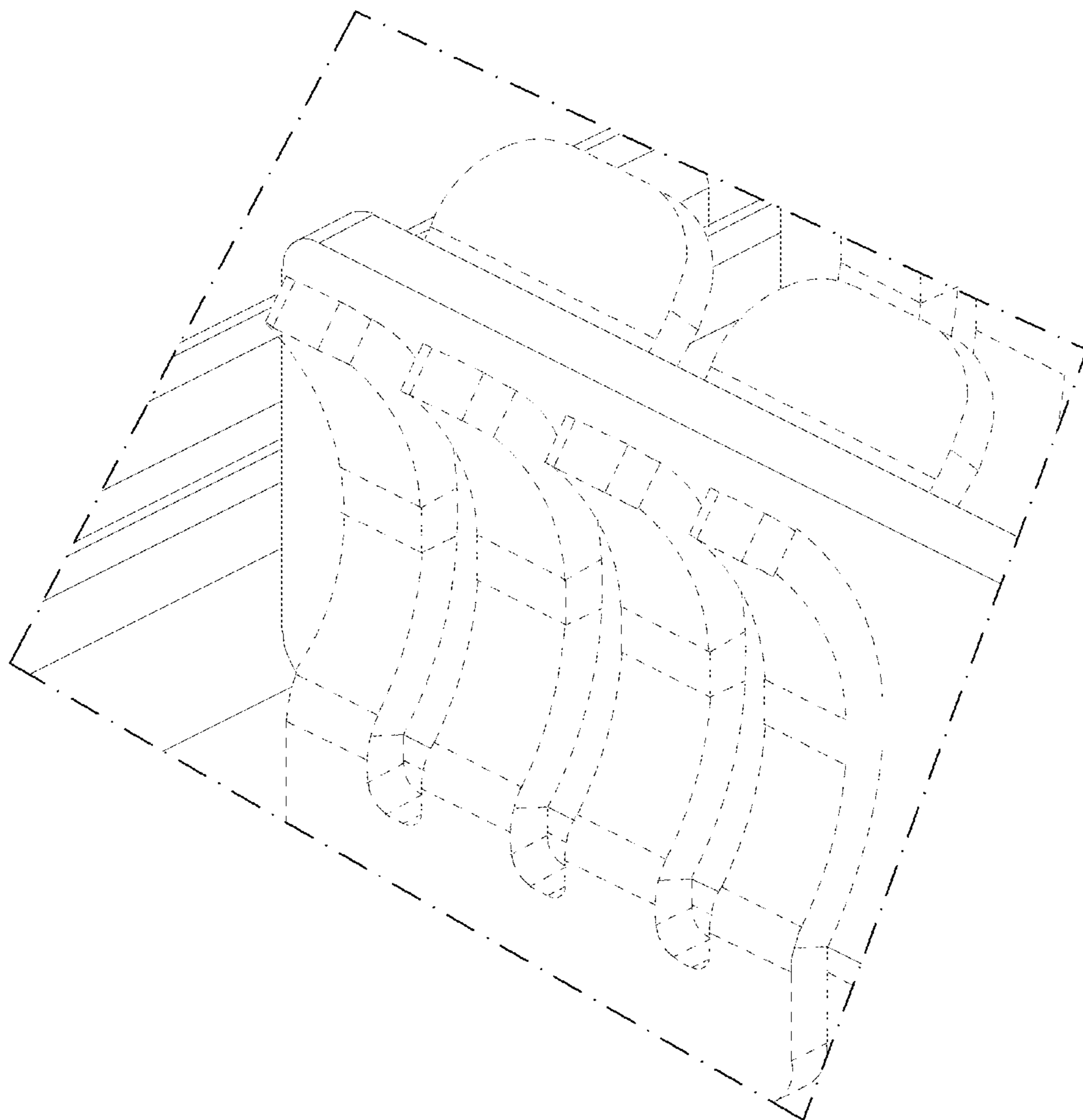

FIG. 96

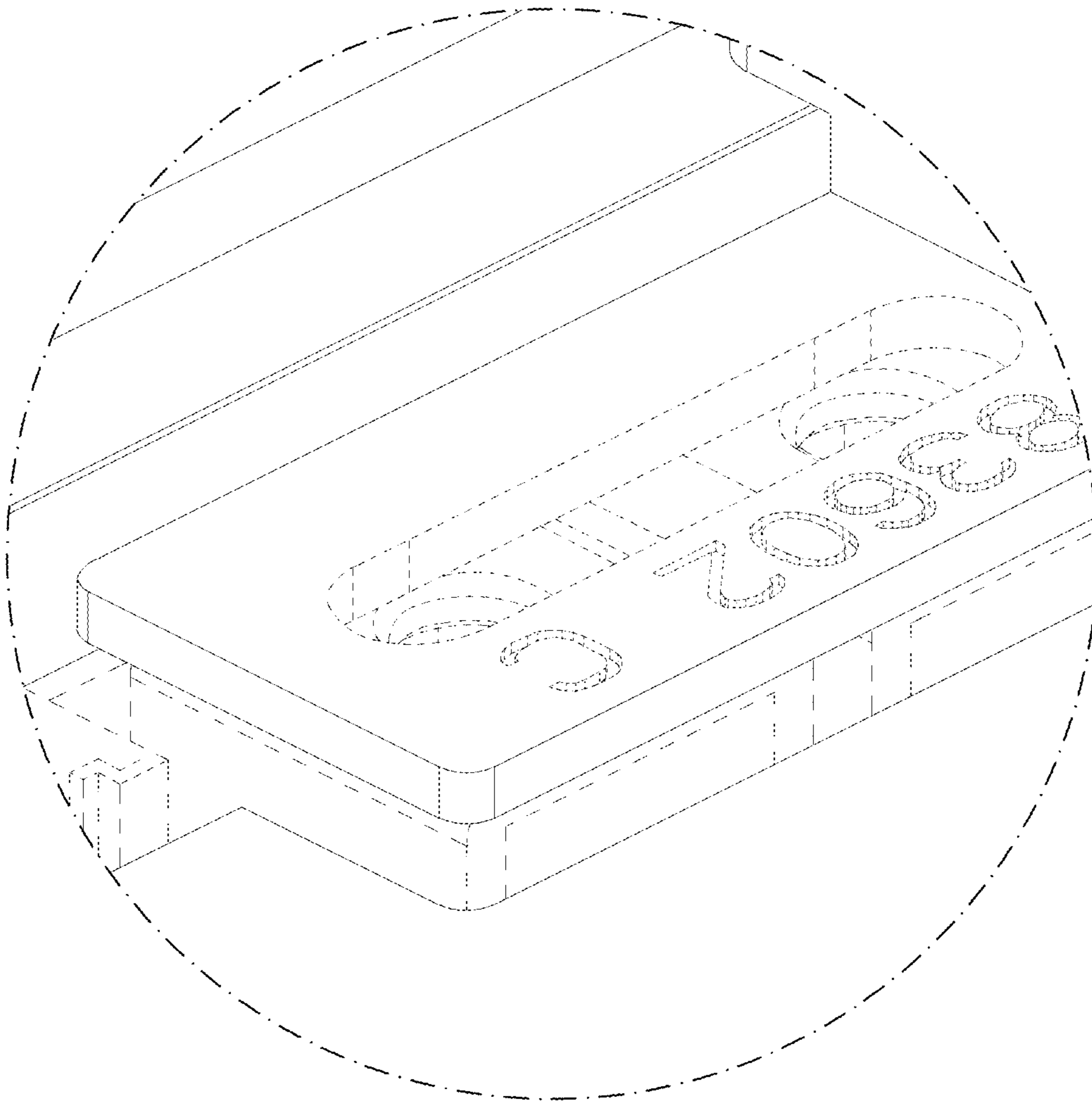

FIG. 97