



US00D973649S

(12) **United States Design Patent** (10) **Patent No.:** **US D973,649 S**  
**Choi et al.** (45) **Date of Patent:** **\*\* Dec. 27, 2022**

(54) **ELECTRONIC DEVICE**

(71) Applicant: **Samsung Electronics Co., Ltd.**,  
Suwon-si (KR)

(72) Inventors: **Duyeong Choi**, Suwon-si (KR);  
**Jaewoong Chung**, Suwon-si (KR);  
**Ethan Lee**, Suwon-si (KR); **Seonkeun**  
**Park**, Suwon-si (KR); **Jungwon Lee**,  
Suwon-si (KR); **Seungjoon Lee**,  
Suwon-si (KR)

(73) Assignee: **Samsung Electronics Co., Ltd.**,  
Suwon-si (KR)

(\*\*) Term: **15 Years**

(21) Appl. No.: **29/775,582**

(22) Filed: **Mar. 24, 2021**

(30) **Foreign Application Priority Data**

Sep. 25, 2020	(KR)	30-2020-0046543
Sep. 25, 2020	(KR)	30-2020-0046544
Sep. 25, 2020	(KR)	30-2020-0046545
Sep. 25, 2020	(KR)	30-2020-0046546
Sep. 25, 2020	(KR)	30-2020-0046547
Sep. 25, 2020	(KR)	30-2020-0046548
Sep. 25, 2020	(KR)	30-2020-0046549
Sep. 25, 2020	(KR)	30-2020-0046550
Sep. 25, 2020	(KR)	30-2020-0046551
Sep. 25, 2020	(KR)	30-2020-0046552
Sep. 25, 2020	(KR)	30-2020-0046553
Sep. 25, 2020	(KR)	30-2020-0046554
Sep. 25, 2020	(KR)	30-2020-0046555
Sep. 25, 2020	(KR)	30-2020-0046556
Sep. 25, 2020	(KR)	30-2020-0046557
Sep. 25, 2020	(KR)	30-2020-0046558
Sep. 25, 2020	(KR)	30-2020-0046559
Sep. 25, 2020	(KR)	30-2020-0046560

(Continued)

(51) **LOC (13) Cl.** ..... **14-03**

(52) **U.S. Cl.**

USPC ..... **D14/248**

(58) **Field of Classification Search**

USPC ..... D14/138 G, 248, 138 C, 138 AB, 341,  
D14/439, 432, 345, 138 R, 138 AA,  
D14/138 AC, 138 AD, 371, 374  
CPC ..... H04M 1/0202; H04M 1/0235; H04M  
1/0237; H04M 1/0239; H04M 1/0266;  
H04M 1/0268; H04M 1/027; H04M  
1/0295;

(Continued)

(56) **References Cited**

**U.S. PATENT DOCUMENTS**

D326,090 S \* 5/1992 Kikuchi ..... D14/138 G  
D593,525 S \* 6/2009 Wang ..... D14/138 G

(Continued)

*Primary Examiner* — Bridget L Eland

(74) *Attorney, Agent, or Firm* — McAndrews, Held &  
Malloy, Ltd.

(57) **CLAIM**

The ornamental design for an electronic device, as shown  
and described.

**DESCRIPTION**

FIG. 1 is a front perspective view of an electronic device  
showing our new design;  
FIG. 2 is a front elevation view thereof;  
FIG. 3 is a rear elevation view thereof;  
FIG. 4 is a left side elevation view thereof;  
FIG. 5 is a right side elevation view thereof;  
FIG. 6 is a top plan view thereof;  
FIG. 7 is a bottom plan view thereof; and,  
FIG. 8 is a rear perspective view thereof.  
The dashed broken lines in the figures illustrate portions of  
the electronic device that form no part of the claimed design.  
The dot-dash broken lines in the drawings define the bound-  
aries of the claimed design and form no part thereof.

**1 Claim, 8 Drawing Sheets**

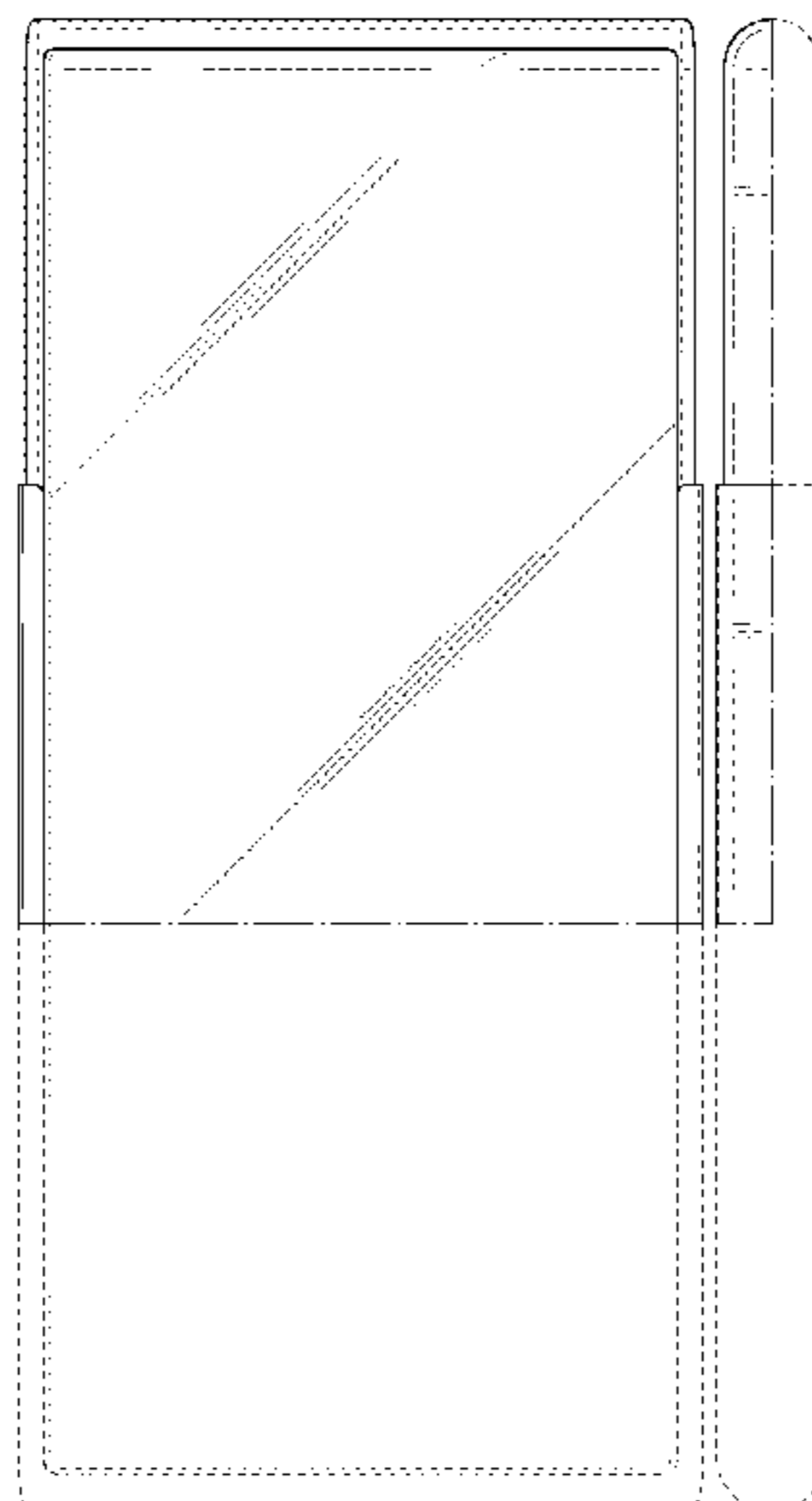

(30) **Foreign Application Priority Data**

Sep. 25, 2020 (KR) ..... 30-2020-0046561  
Sep. 25, 2020 (KR) ..... 30-2020-0046562

(58) **Field of Classification Search**

CPC ... H04M 1/02; H04M 1/0279; H04M 1/0283  
See application file for complete search history.

(56) **References Cited**

U.S. PATENT DOCUMENTS

D603,361 S \* 11/2009 Kang ..... D14/138 G  
D621,379 S \* 8/2010 Song ..... D14/138 R  
D628,547 S \* 12/2010 Park ..... D14/138 AD  
D628,549 S \* 12/2010 Park ..... D14/138 AD  
D659,131 S \* 5/2012 Mori ..... D14/248  
D778,863 S \* 2/2017 Lee ..... D14/138 G  
D781,806 S \* 3/2017 Lee ..... D14/138 G  
D826,202 S \* 8/2018 Park ..... D14/138 G  
D890,712 S \* 7/2020 Liu ..... D14/138 G  
D891,386 S \* 7/2020 Liu ..... D14/138 G  
D897,978 S \* 10/2020 Nam ..... D14/138 G  
D901,488 S \* 11/2020 Seo ..... D14/341  
10,963,014 B1 \* 3/2021 Park ..... H04B 1/3827  
D936,028 S \* 11/2021 Yi ..... D14/138 G  
11,194,363 B2 \* 12/2021 Kim ..... G06F 1/1637  
D951,218 S \* 5/2022 Han ..... D14/138 G  
D955,357 S \* 6/2022 Sun ..... D14/138 AD  
D958,769 S \* 7/2022 Ji ..... D14/138 AD  
2010/0273542 A1 \* 10/2010 Holman, IV ..... H04M 1/0237  
455/575.4  
2019/0346954 A1 \* 11/2019 Jung ..... G06F 1/3209  
2019/0386696 A1 \* 12/2019 Luo ..... H04B 1/3888  
2020/0409421 A1 \* 12/2020 Cho ..... H04M 1/0268  
2022/0104364 A1 \* 3/2022 Yang ..... G06F 1/16

\* cited by examiner

FIG. 1

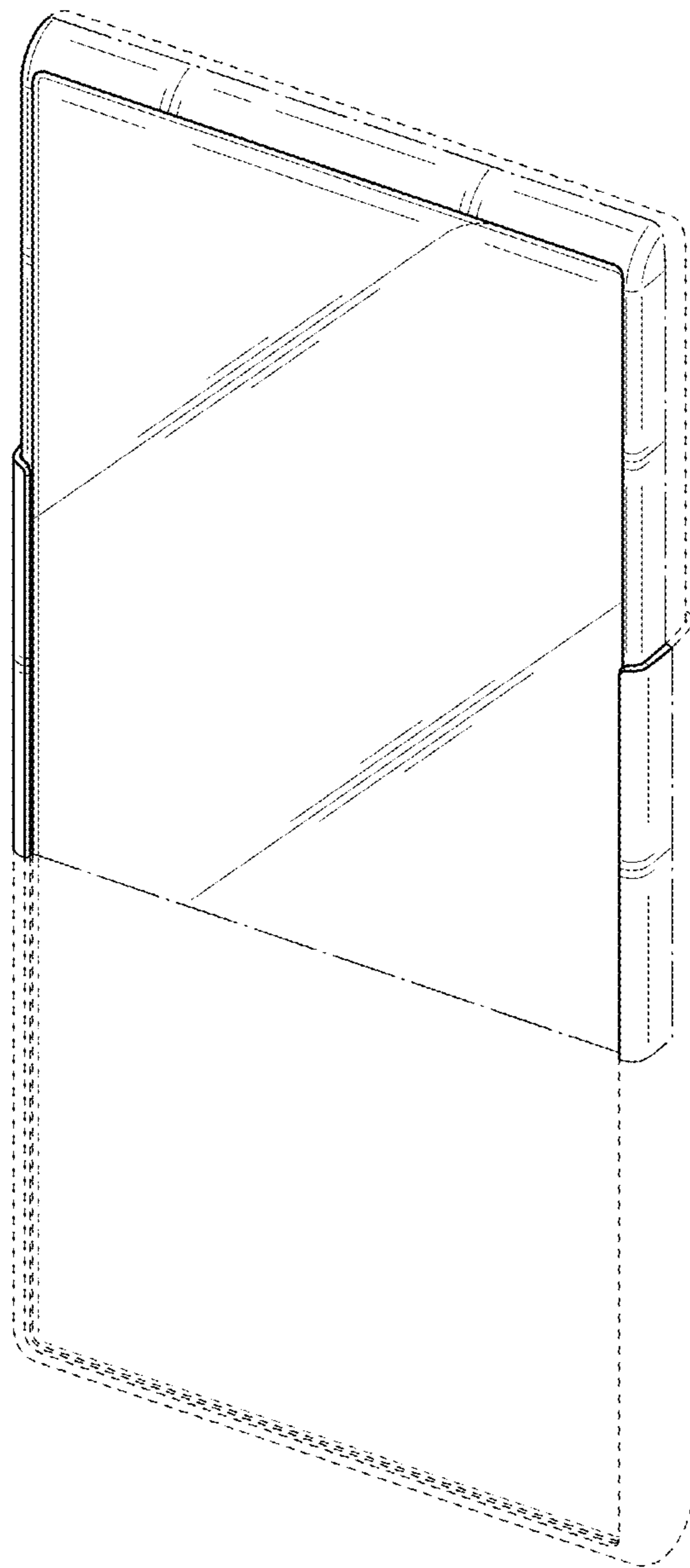

FIG. 2

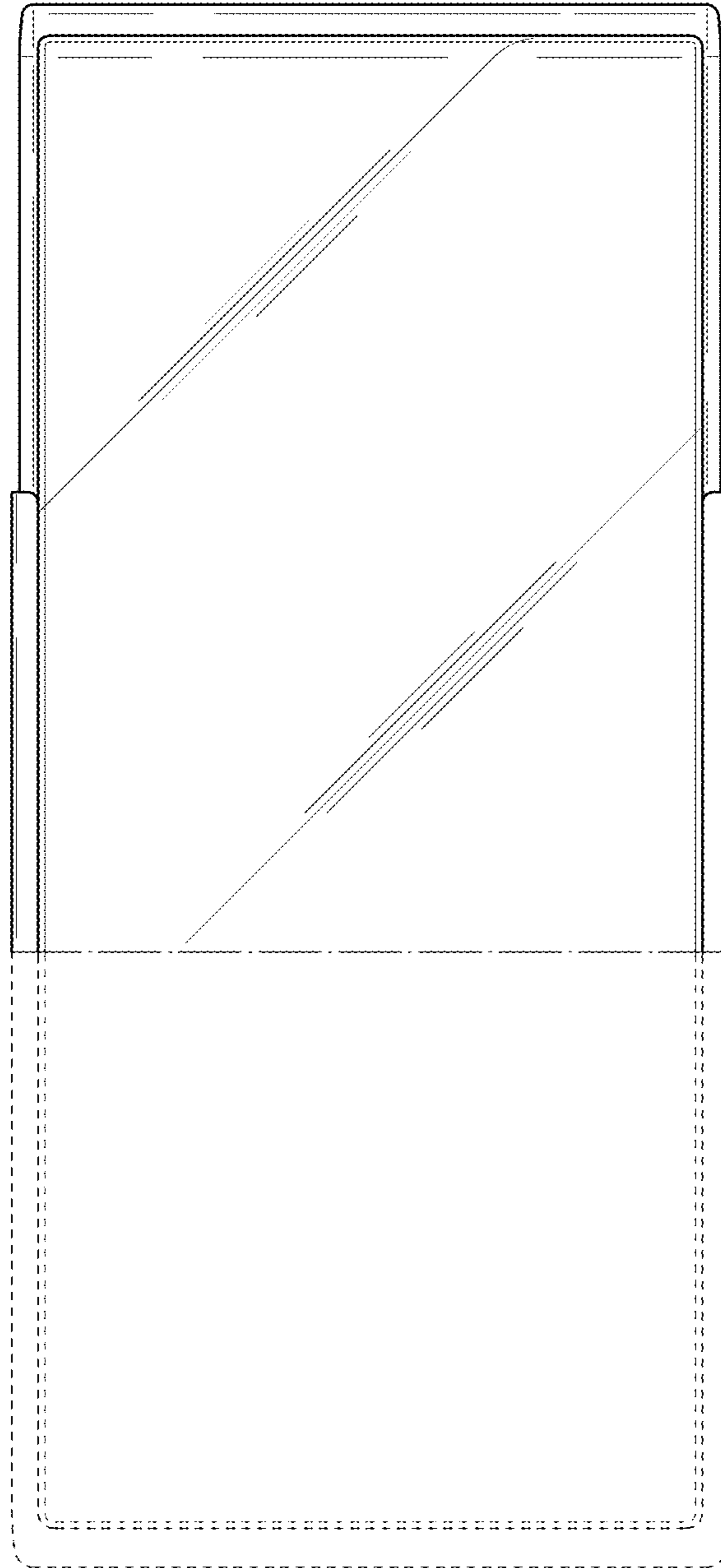

FIG. 3

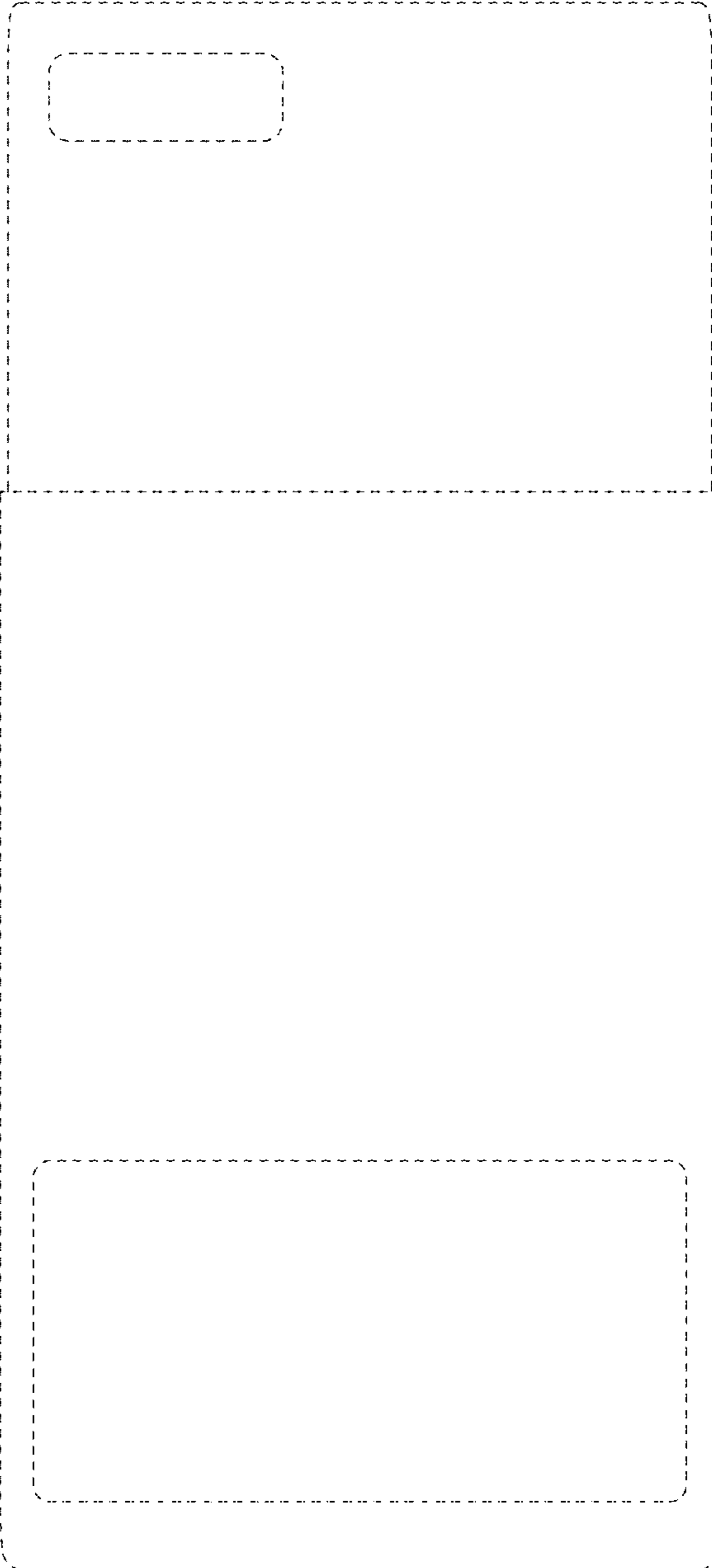

FIG. 4

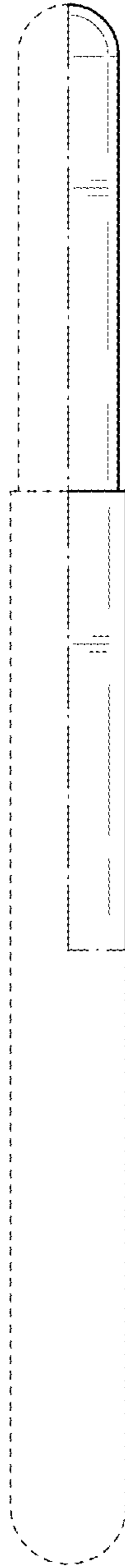

FIG. 5

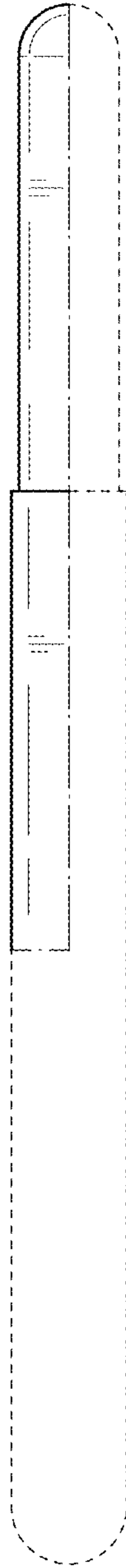

FIG. 6

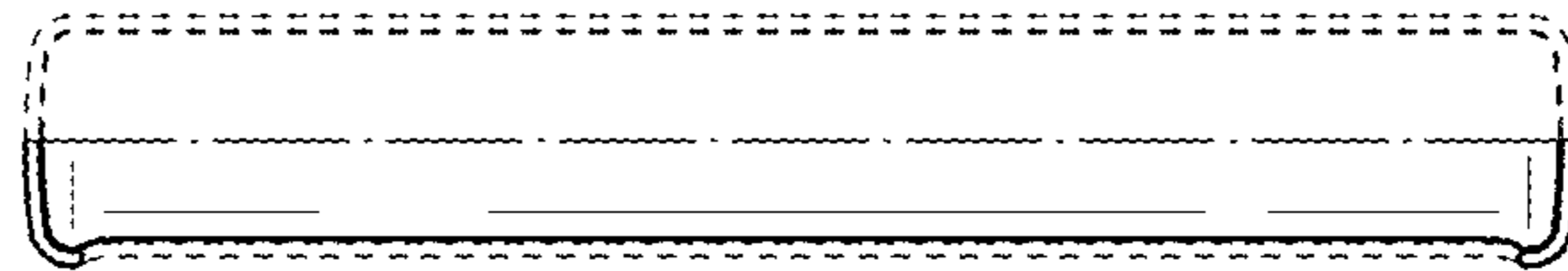



FIG. 7



FIG. 8

