



US00D973522S

(12) **United States Design Patent**  
**Marzette, Jr. et al.**

(10) **Patent No.:** **US D973,522 S**  
(45) **Date of Patent:** **\*\* Dec. 27, 2022**

(54) **CLAMP METER**

(71) Applicant: **Fluke Corporation**, Everett, WA (US)  
(72) Inventors: **Charles E. Marzette, Jr.**, Kirkland, WA (US); **Tracy J. Kearsley**, Stanwood, WA (US)  
(73) Assignee: **Fluke Corporation**, Everett, WA (US)  
(\*\*) Term: **15 Years**

(21) Appl. No.: **29/771,494**  
(22) Filed: **Feb. 23, 2021**  
(51) **LOC (13) Cl.** ..... **10-04**  
(52) **U.S. Cl.**  
USPC ..... **D10/79**  
(58) **Field of Classification Search**  
USPC ..... D10/79  
CPC ..... G01R 1/04; G01R 1/0408; G01R 1/0416;  
G01R 1/0425; G01R 1/06; G01R 1/067;  
G01R 15/125; G01R 1/22; G01R 15/12;  
G01R 15/18; G01R 15/186; G01R 1/07;  
G01R 1/16772; G01R 1/16788  
See application file for complete search history.

(56) **References Cited**

**U.S. PATENT DOCUMENTS**

D359,006 S *	6/1995	McCain	.....	D10/79
D413,538 S *	9/1999	Chen	.....	G01R 1/02
				D10/79
D457,451 S *	5/2002	Chen	.....	G01R 1/22
				D10/79
D467,190 S *	12/2002	Ikeda	.....	D10/79
D515,953 S *	2/2006	Chang	.....	D10/79
D517,434 S *	3/2006	Chang	.....	D10/79
D567,687 S *	4/2008	Elrod	.....	D10/79
D628,918 S *	12/2010	Chang	.....	D10/79
D640,152 S *	6/2011	Laurino	.....	G01R 1/22
				D10/79

(Continued)

**OTHER PUBLICATIONS**

Fluke Corporation, "365 True-rms AC Clamp Meter Rugged meters where access is difficult", 2010, 2 pgs.  
(Continued)

*Primary Examiner* — Antoine Duval Davis  
(74) *Attorney, Agent, or Firm* — Seed Intellectual Property Law Group LLP

(57) **CLAIM**

The ornamental design for a clamp meter, as shown and described.

**DESCRIPTION**

FIG. 1 is a top, front, right side perspective view of a clamp meter showing our new design.  
FIG. 2 is a bottom, rear, left side perspective view thereof.  
FIG. 3 is a front elevation view thereof.  
FIG. 4 is a left side elevation view thereof.  
FIG. 5 is a right side elevation view thereof.  
FIG. 6 is a rear elevation view thereof.  
FIG. 7 is a top plan view thereof.  
FIG. 8 is a bottom plan view thereof.  
FIG. 9 is a top, front, right side perspective view of another embodiment of a clamp meter showing our new design.  
FIG. 10 is a bottom, rear, left side perspective view thereof.  
FIG. 11 is a front elevation view thereof.  
FIG. 12 is a left side elevation view thereof.  
FIG. 13 is a right side elevation view thereof.  
FIG. 14 is a rear elevation view thereof.  
FIG. 15 is a top plan view thereof; and,  
FIG. 16 is a bottom plan view thereof.  
The broken lines in the figures represent aspects of the clamp meter that form no part of the claimed design.

**1 Claim, 12 Drawing Sheets**

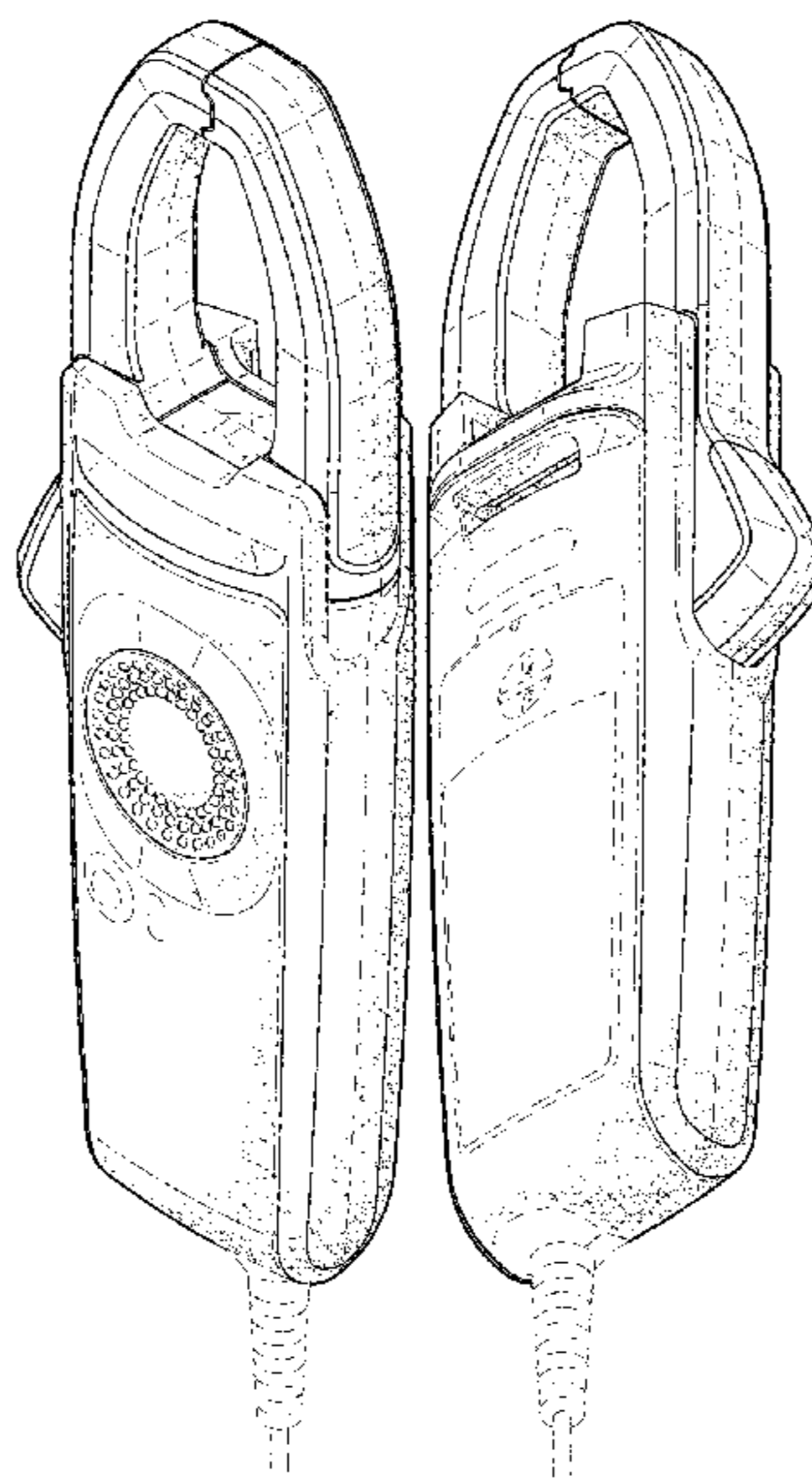

(56)

**References Cited**

U.S. PATENT DOCUMENTS

D683,250 S \* 5/2013 Marzynski ..... G01R 19/2503  
D10/79  
D848,878 S \* 5/2019 Jiang ..... G01R 1/22  
D10/79  
D938,843 S \* 12/2021 Woo ..... D10/79  
2009/0058399 A1\* 3/2009 Wang ..... G01R 1/22  
324/127  
2011/0015796 A1\* 1/2011 Heydron ..... G01R 1/02  
700/286  
2011/0316523 A1\* 12/2011 Ko ..... G01R 19/2503  
324/115  
2012/0020049 A1\* 1/2012 Ko ..... G01R 15/12  
362/23.07  
2020/0386789 A1\* 12/2020 Nakajima ..... G01R 15/18  
2021/0041483 A1\* 2/2021 Worones ..... G01R 1/22

OTHER PUBLICATIONS

Fluke Corporation, "Four Things to Consider When Buying a Clamp Meter", 2013, 2 pgs.

Fluke Corporation, "Technical Data Fluke 377 FC, 378 FC Non-Contact Voltage True-rms AC/DC Clamp Meters with iFlex", 2020, 6 pgs.

\* cited by examiner

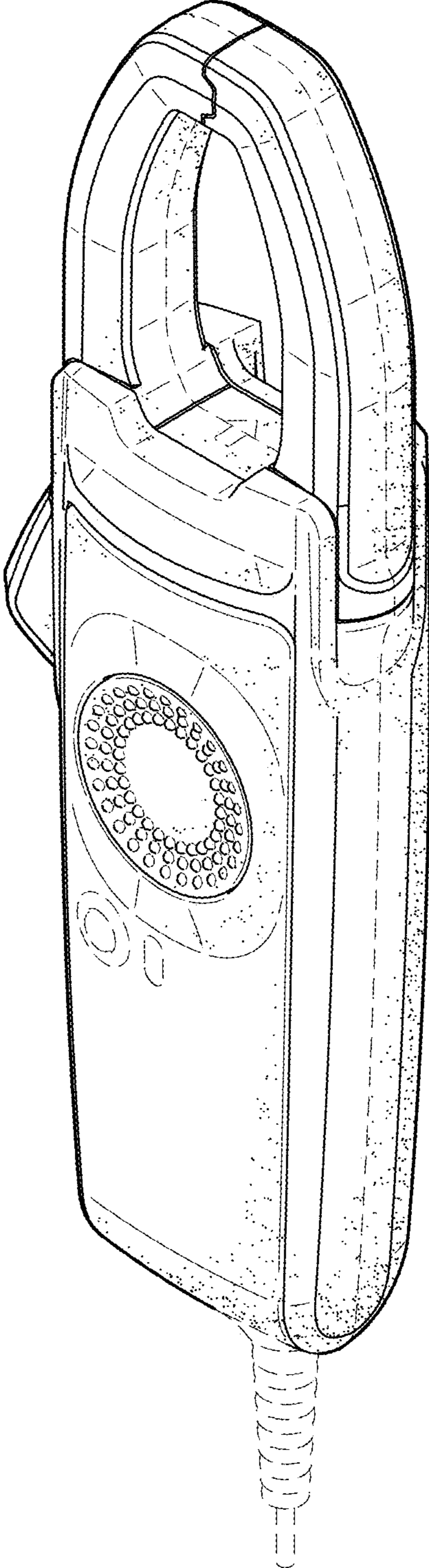

FIG. 1

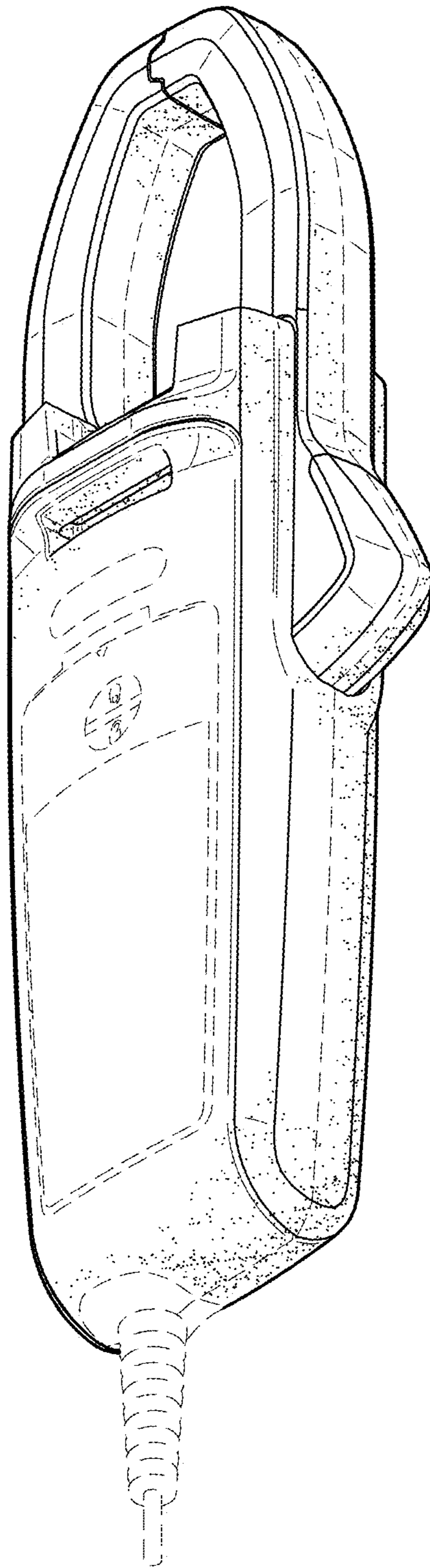

FIG. 2

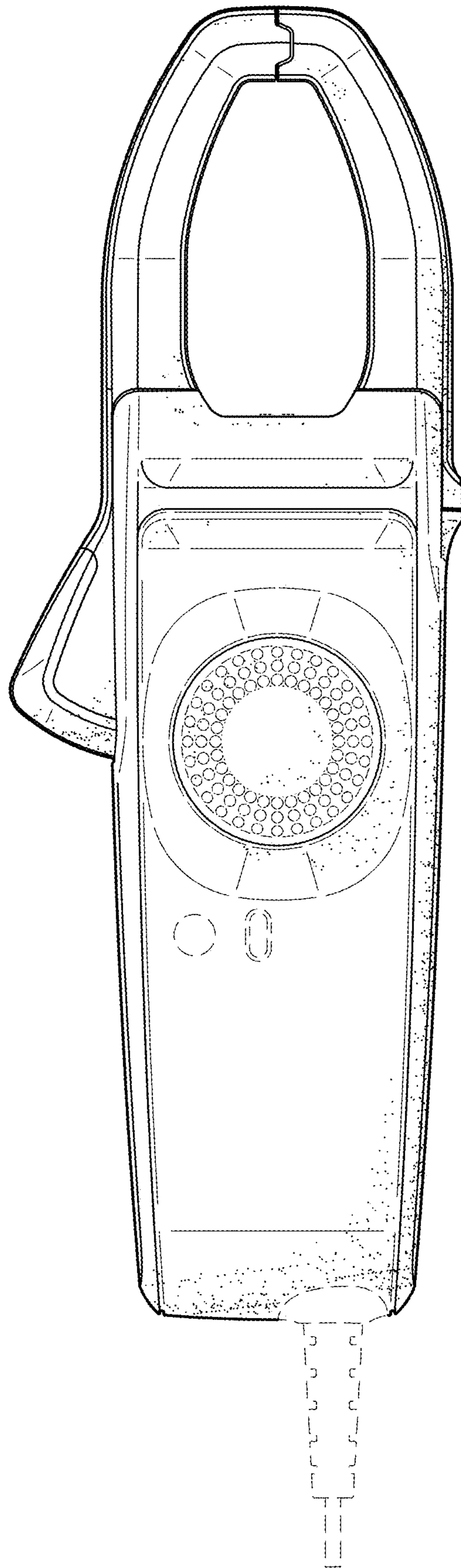

FIG. 3

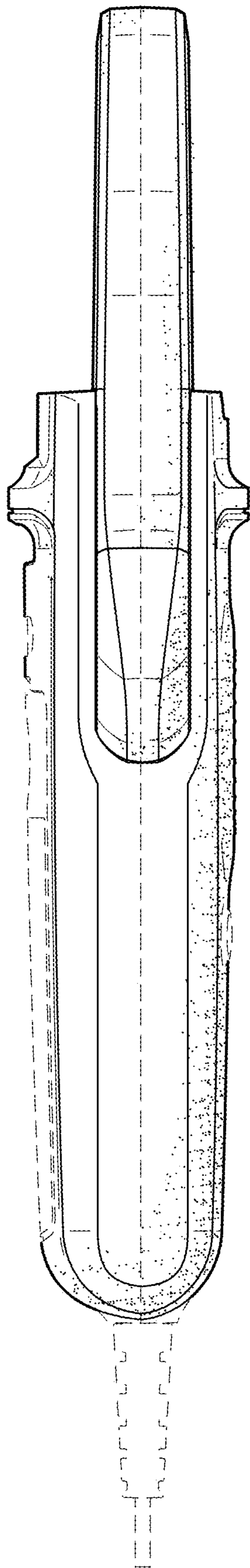

FIG. 4

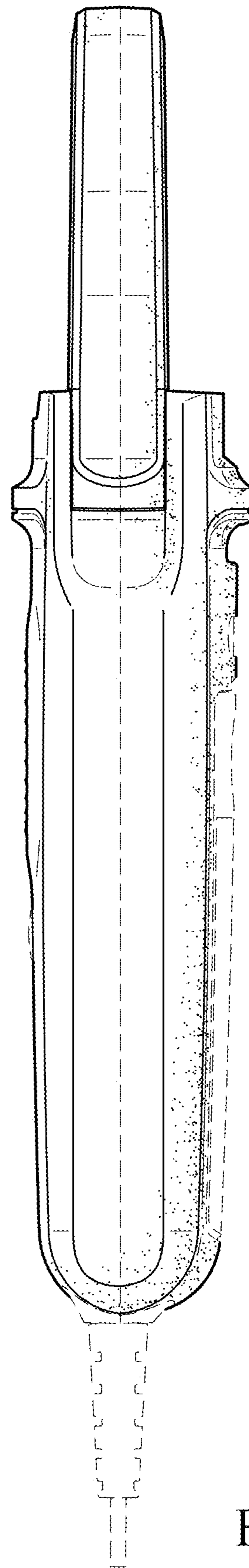

FIG. 5

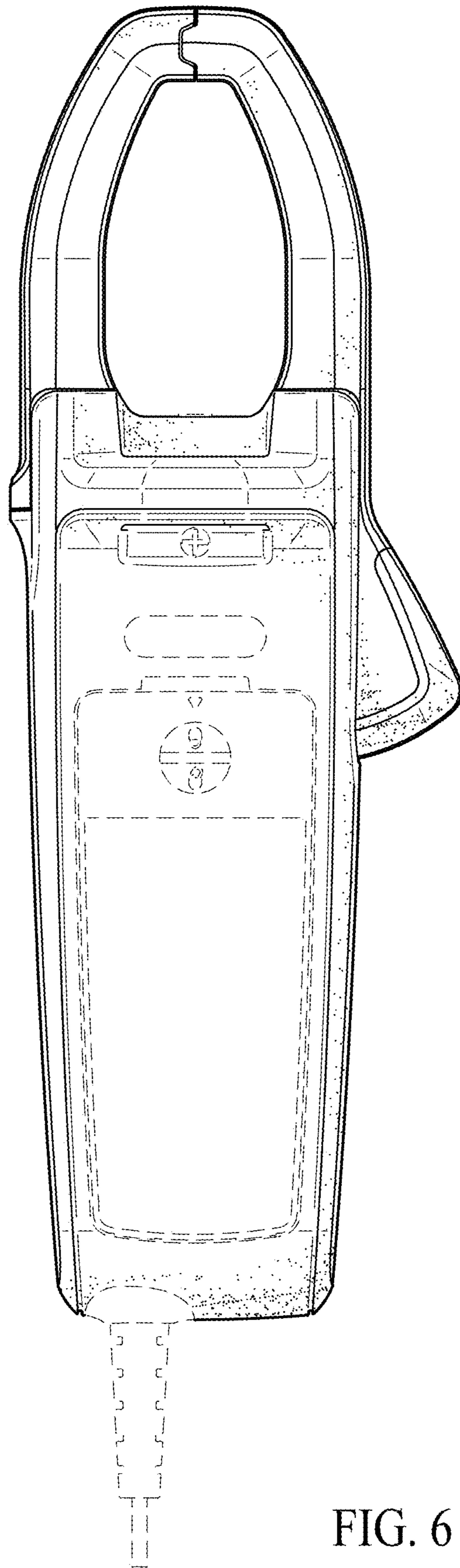

FIG. 6

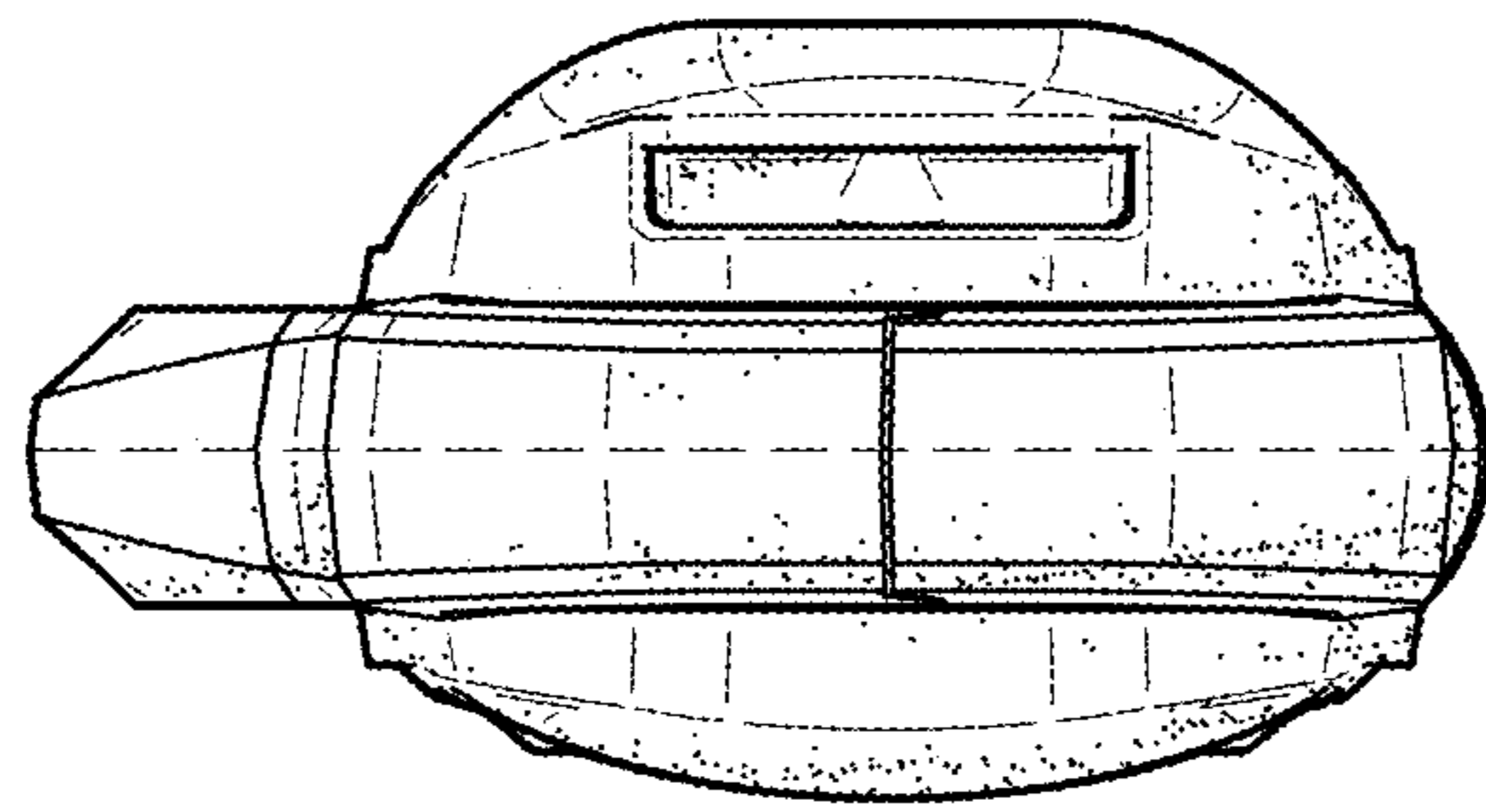

FIG. 7

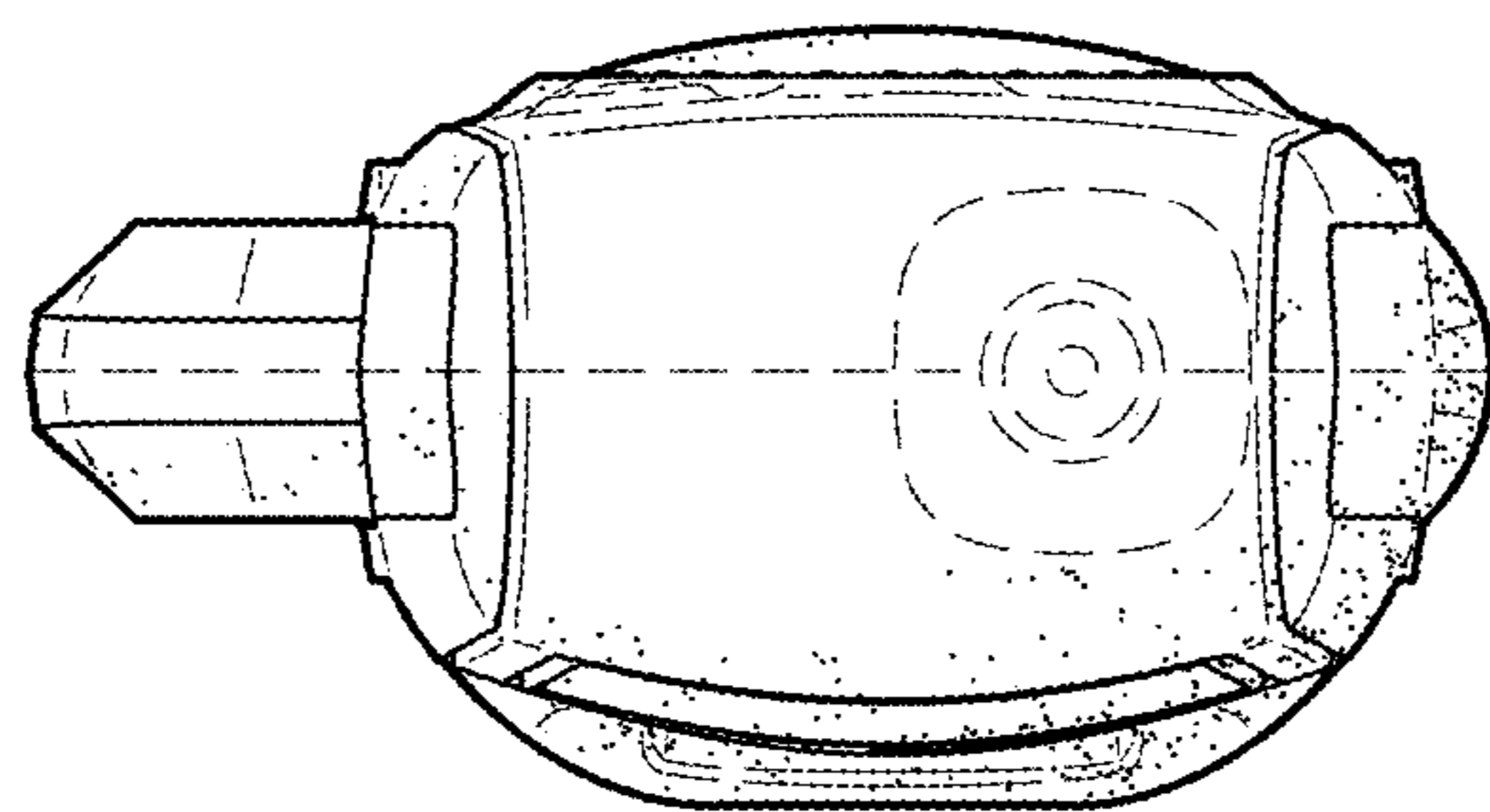

FIG. 8



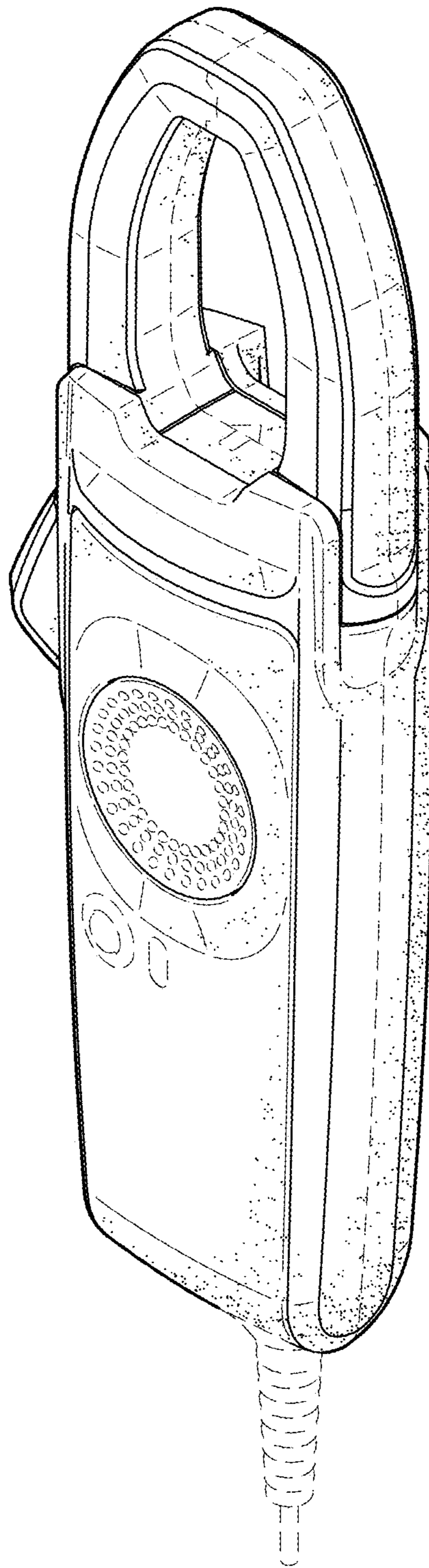

FIG. 9

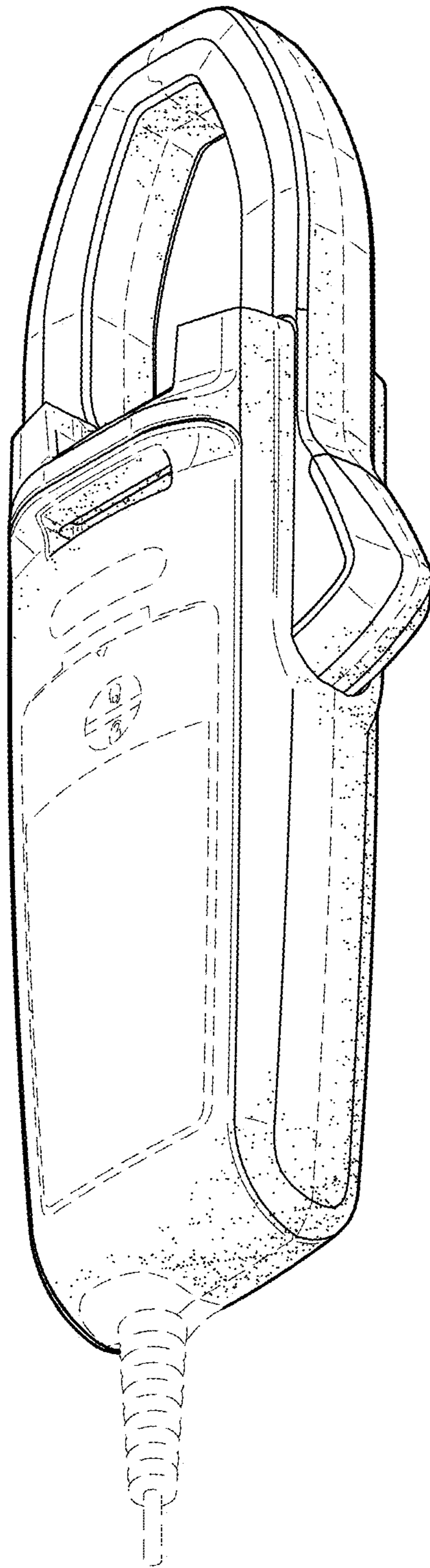

FIG. 10

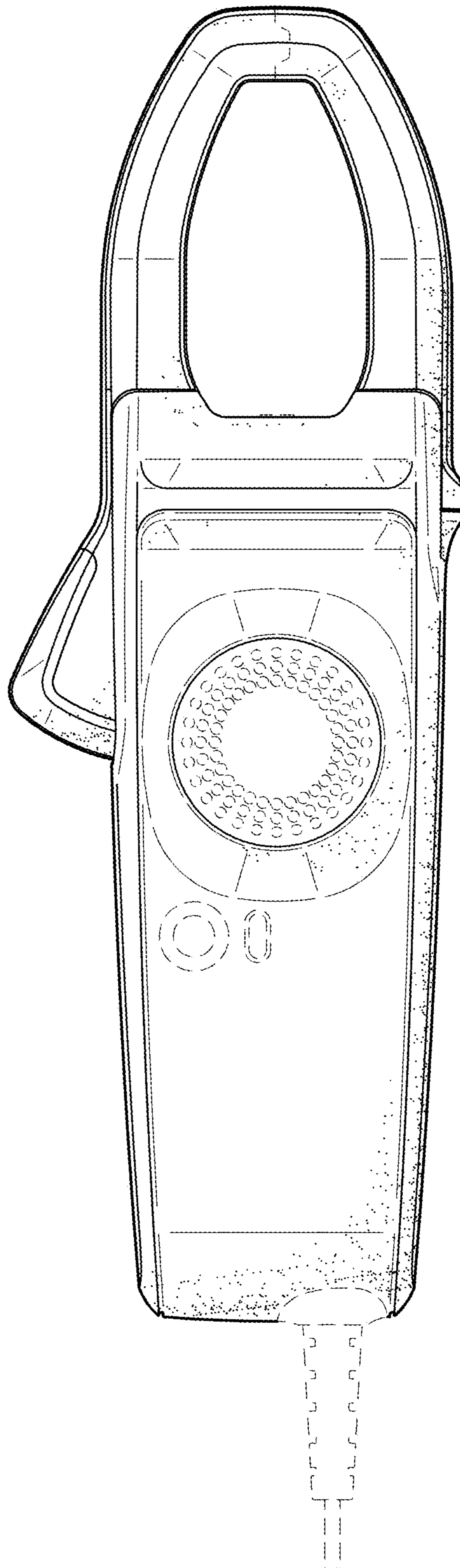

FIG. 11

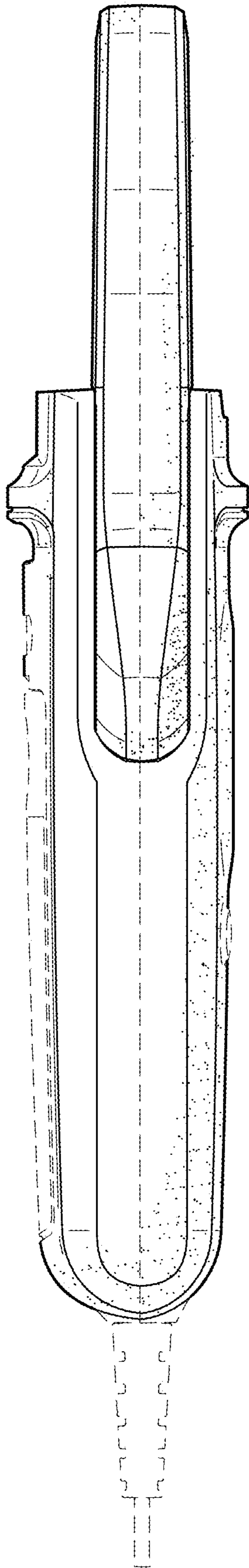

FIG. 12

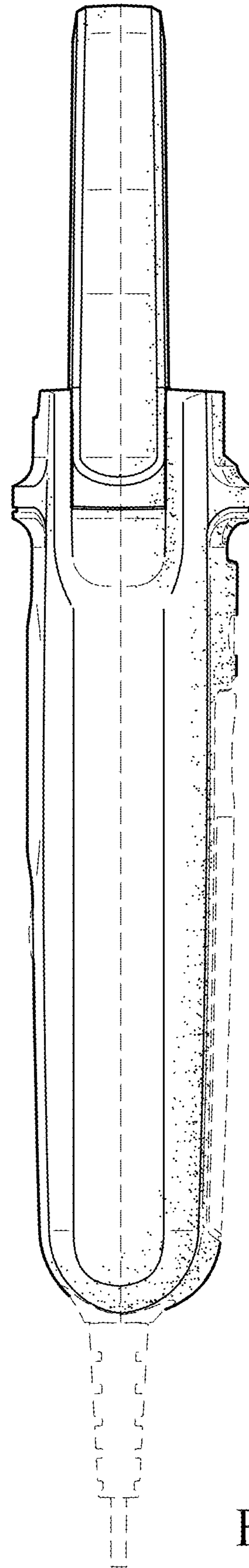

FIG. 13

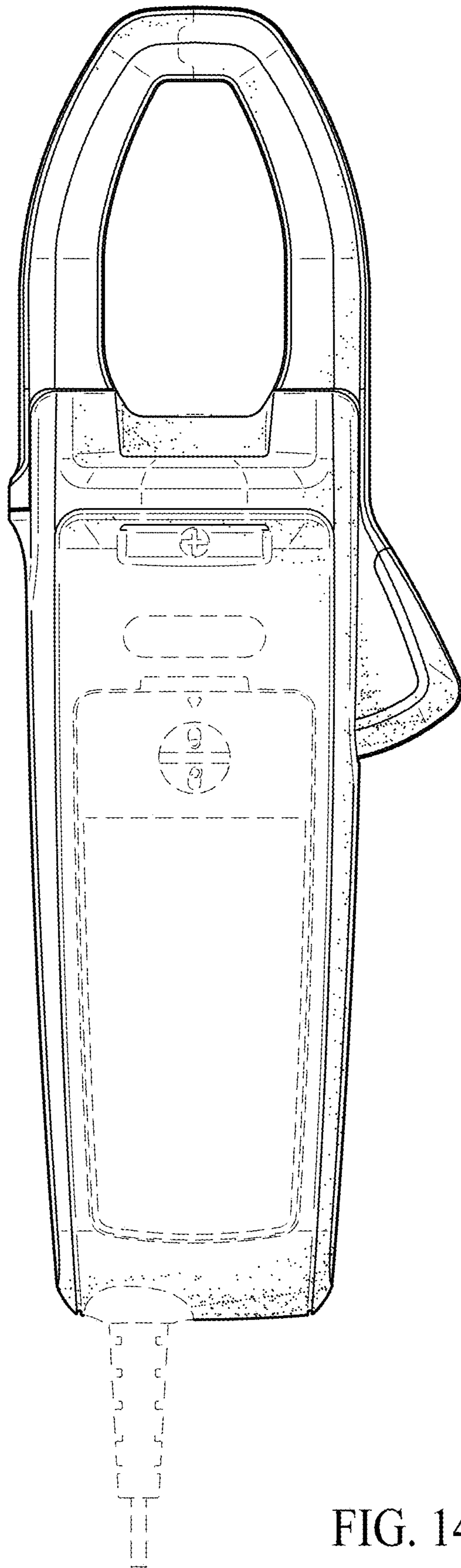

FIG. 14

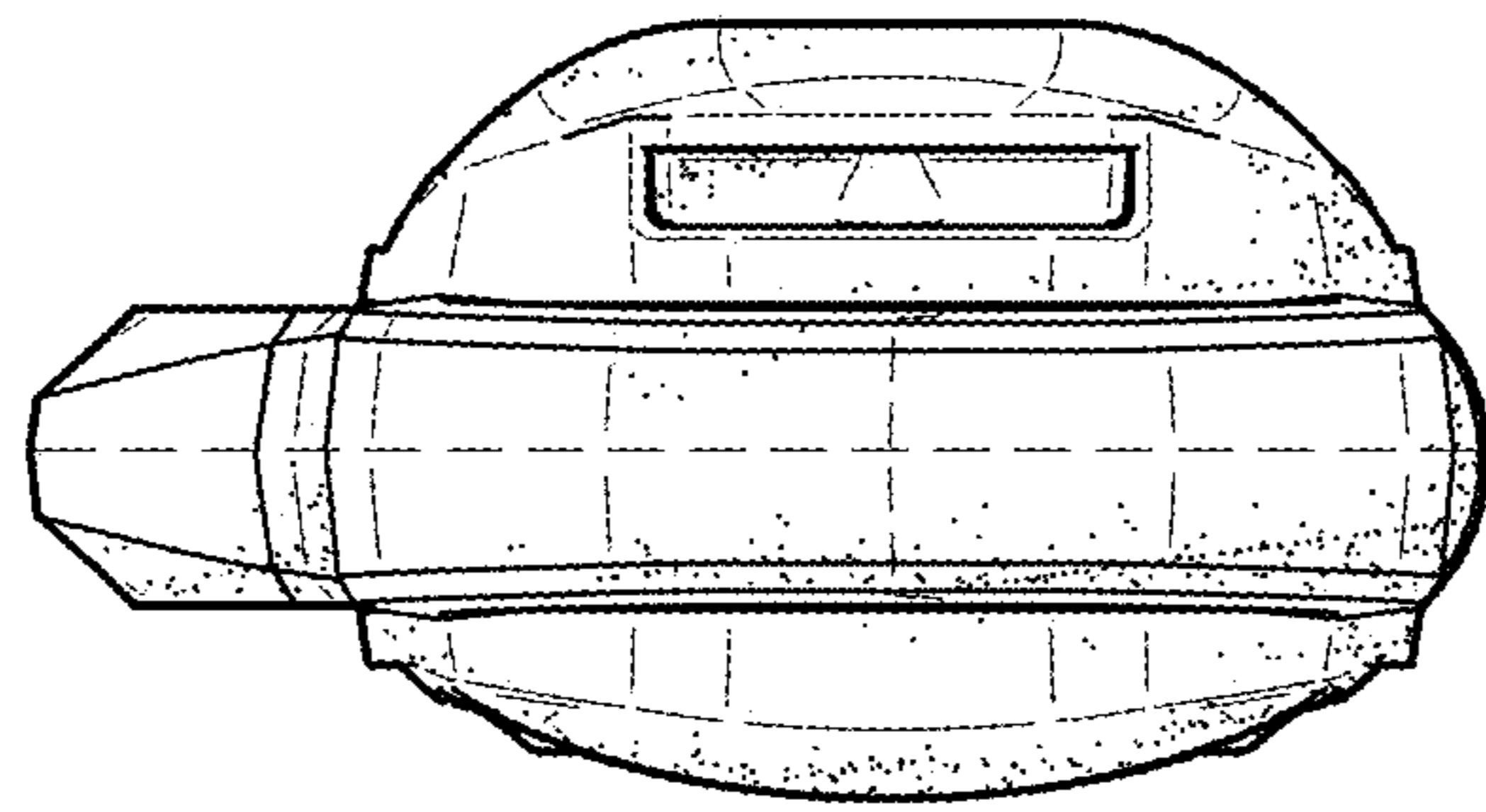

FIG. 15

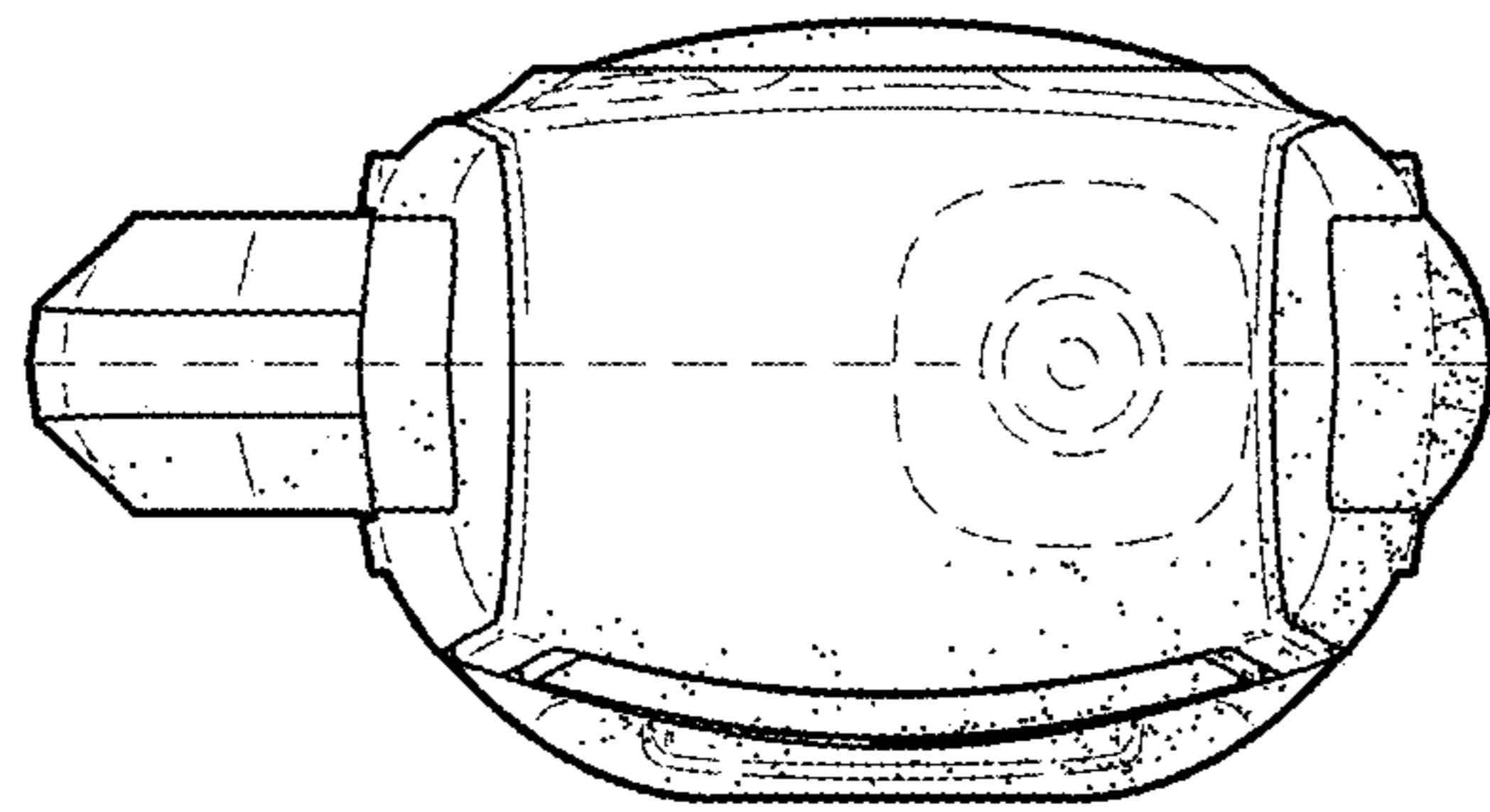

FIG. 16