



US00D973480S

(12) **United States Design Patent** (10) **Patent No.:** **US D973,480 S**
Tu (45) **Date of Patent:** **** Dec. 27, 2022**

(54) **COMBINED DOOR STOPPER AND WHEEL STOPPER**

(71) Applicant: **Yunhua Tu**, Fuzhou (CN)

(72) Inventor: **Yunhua Tu**, Fuzhou (CN)

(**) Term: **15 Years**

(21) Appl. No.: **29/798,026**

(22) Filed: **Jul. 5, 2021**

(30) **Foreign Application Priority Data**

Jun. 8, 2021 (CN) 202130351922.8

(51) **LOC (13) Cl.** **08-09**

(52) **U.S. Cl.**
USPC **D8/402**

(58) **Field of Classification Search**
USPC D8/358, 363, 365, 366, 371, 373, 374,
D8/375, 380, 381, 382, 387, 391, 393,
D8/394, 396, 370, 402
CPC .. F16B 7/0466; F16B 7/04; F16L 3/00; E04B
2001/405; B60B 33/0089; B60B 33/0097
See application file for complete search history.

(56) **References Cited**

U.S. PATENT DOCUMENTS

D44,952 S * 12/1913 Buser D8/374
5,210,903 A * 5/1993 Horning B60B 33/00
248/352
6,003,911 A * 12/1999 Sowash E05C 17/025
292/288
D538,504 S * 3/2007 Pham D12/217
7,581,623 B1 * 9/2009 Egnor B60T 3/00
188/32
D762,464 S * 8/2016 Peterson D8/402
9,586,562 B1 * 3/2017 Noonan B60T 3/00
D783,394 S * 4/2017 Peterson D8/402

D813,019 S * 3/2018 Wendling D8/374
D817,161 S * 5/2018 Hamann D8/375
10,343,656 B2 * 7/2019 Grosz B60T 3/00
D878,915 S * 3/2020 Parzych
D879,600 S * 3/2020 Ludwig D8/402
D885,881 S * 6/2020 Dong
D893,288 S * 8/2020 Wendling D8/374
10,760,309 B1 * 9/2020 Bowman E05C 17/54
D938,805 S * 12/2021 Thaler D8/354
D953,929 S * 6/2022 Steininger D12/51

OTHER PUBLICATIONS

www.ebay.com, 4pcs Wheel Door Stoppers Rubber Door Stops for Bedroom Kitchen, Aug. 14, 2021 (found in revisions as first day posted) Revision summary for item #373684995318 (Year: 2022).*

* cited by examiner

Primary Examiner — Keli L Hill

Assistant Examiner — Harold E Blackwell, II

(57) **CLAIM**

The ornamental design for a combined door stopper and wheel stopper, as shown and described.

DESCRIPTION

FIG. 1 is a perspective view of a combined door stopper and wheel stopper showing my new design; FIG. 2 is another perspective view thereof; FIG. 3 is a front elevational view thereof; FIG. 4 is a rear elevational view thereof; FIG. 5 is a left side elevational view thereof; FIG. 6 is a right side elevational view thereof; FIG. 7 is a top plan view thereof; and, FIG. 8 is a bottom plan view thereof. The broken lines in the drawings depict portions of the combined door stopper and wheel stopper that form no part of the claimed design.

1 Claim, 8 Drawing Sheets

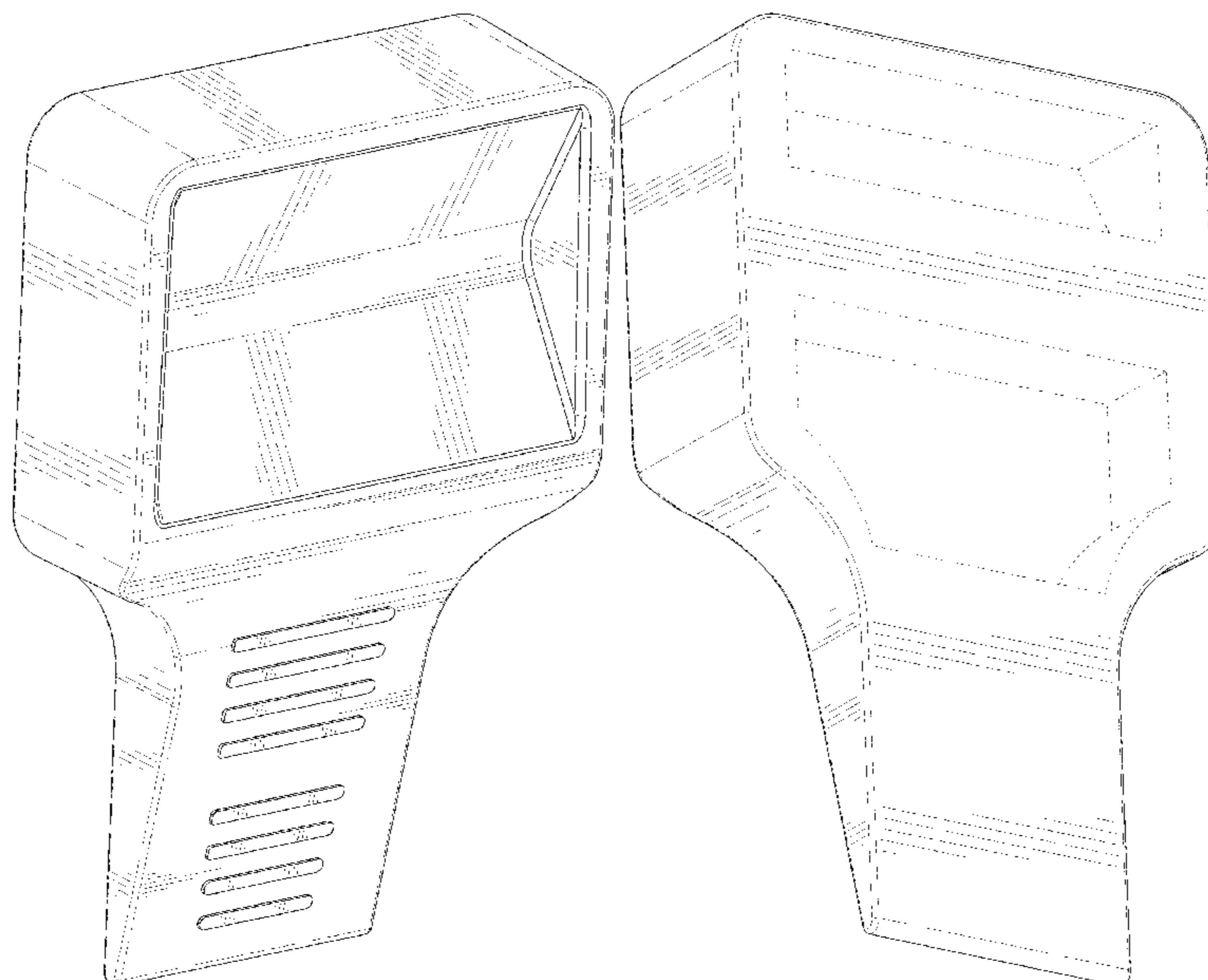

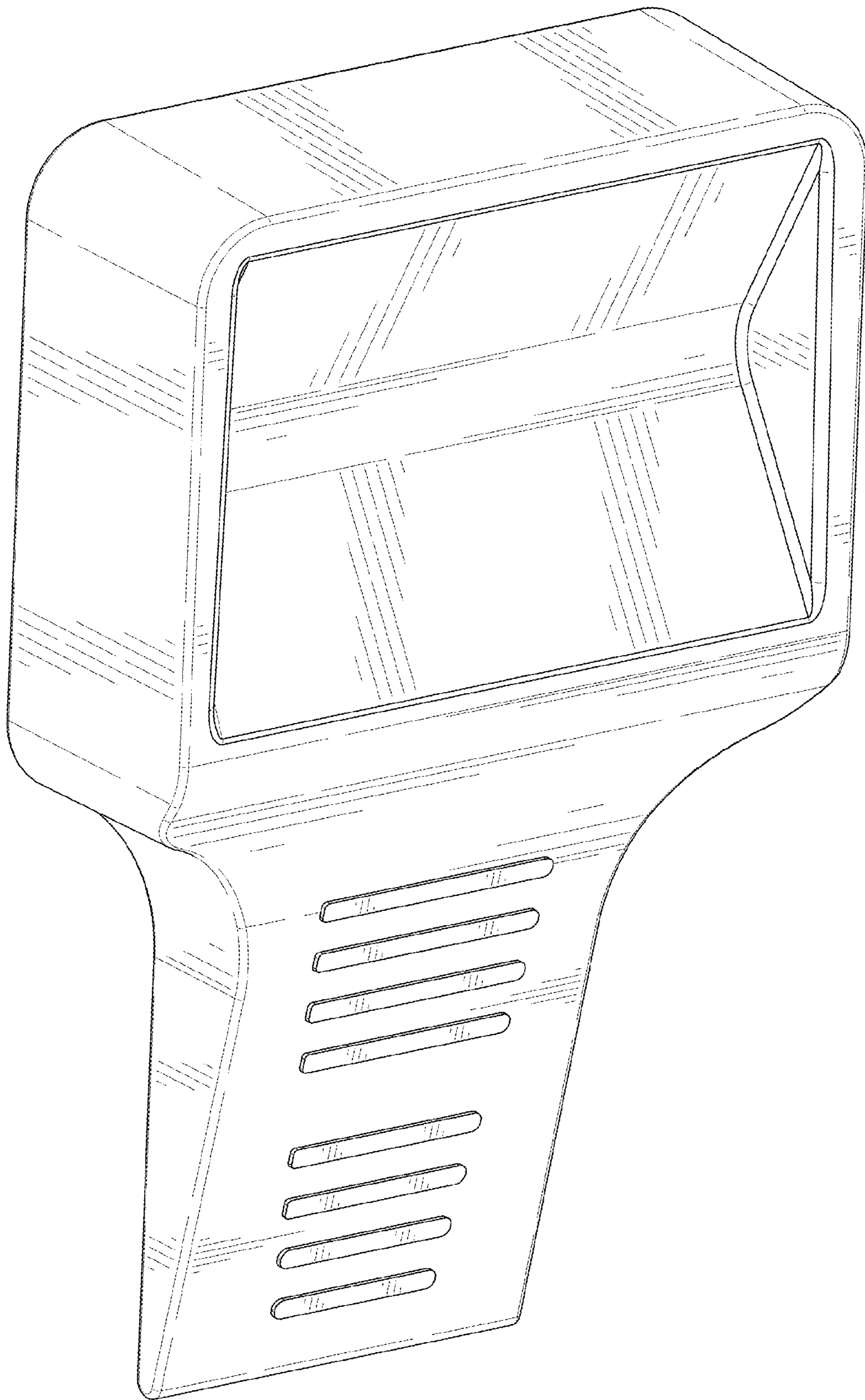

FIG. 1

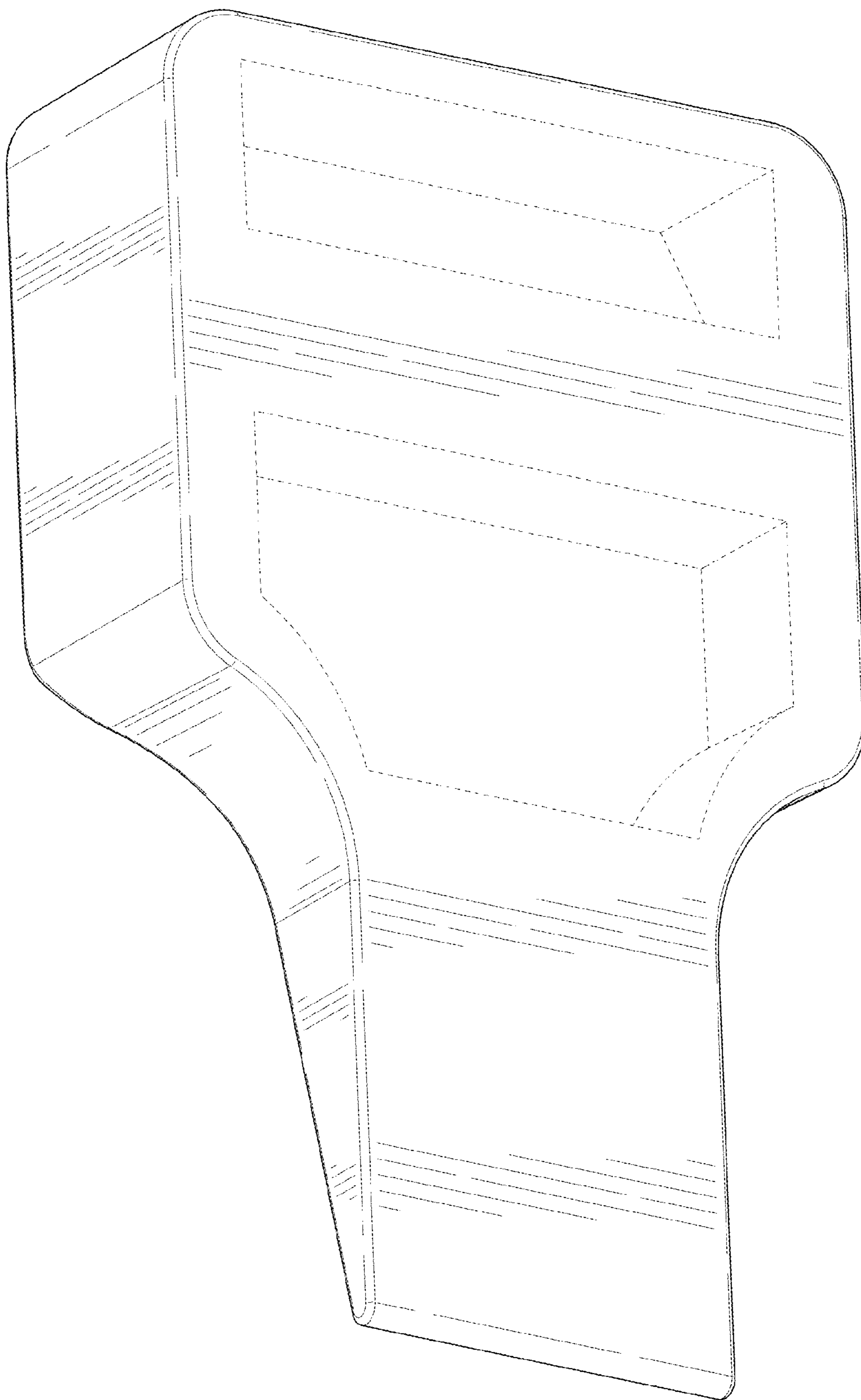

FIG. 2

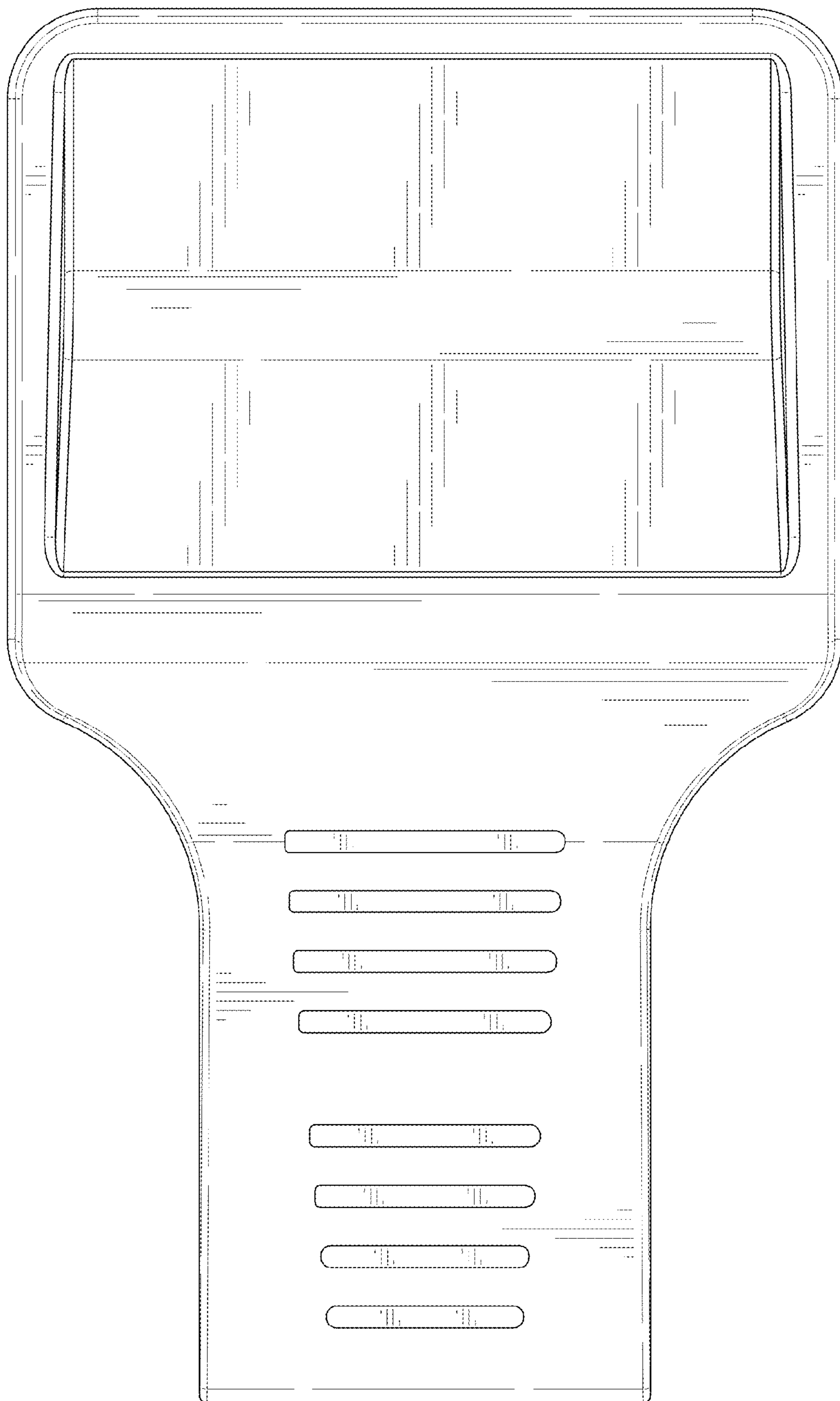

FIG. 3

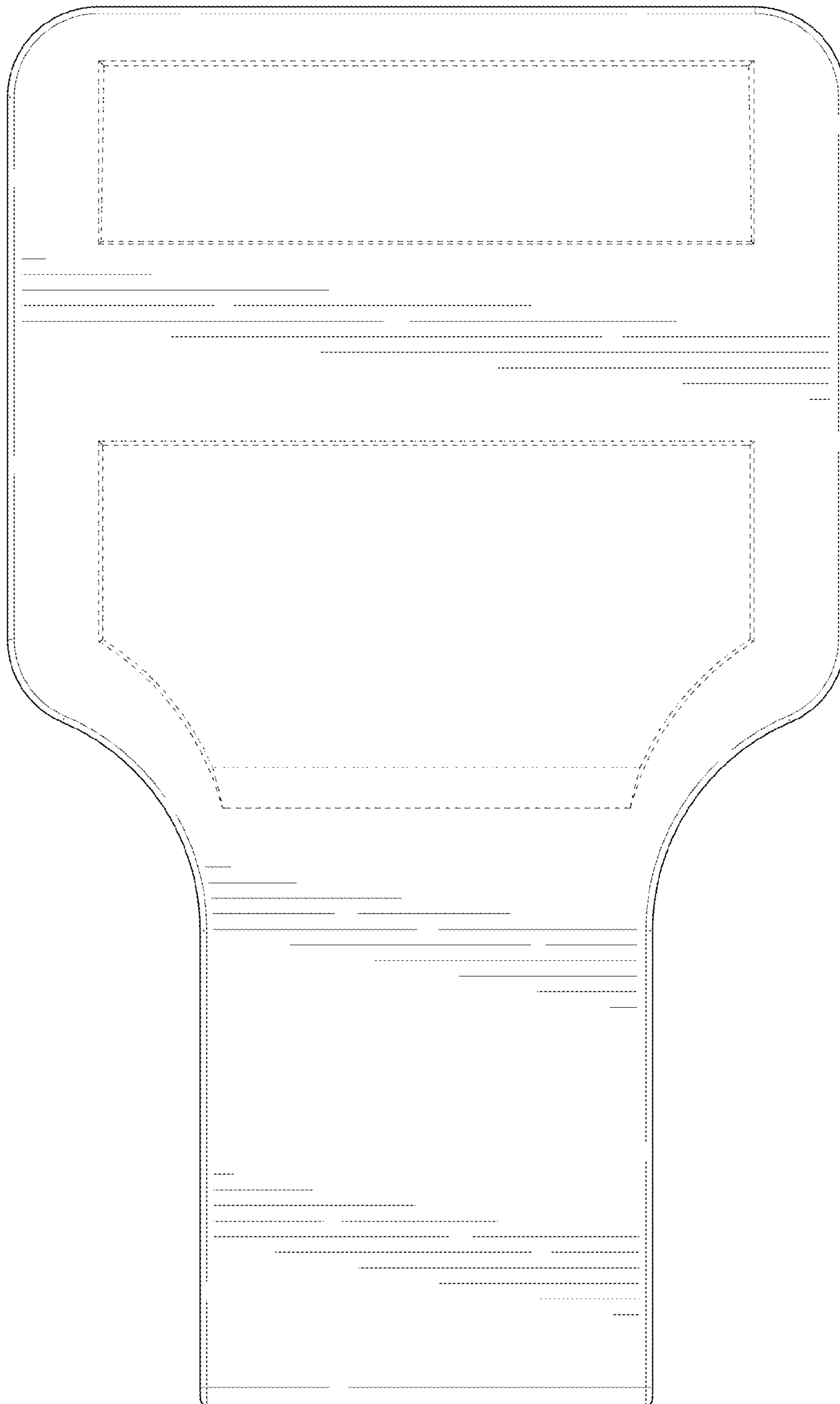

FIG. 4

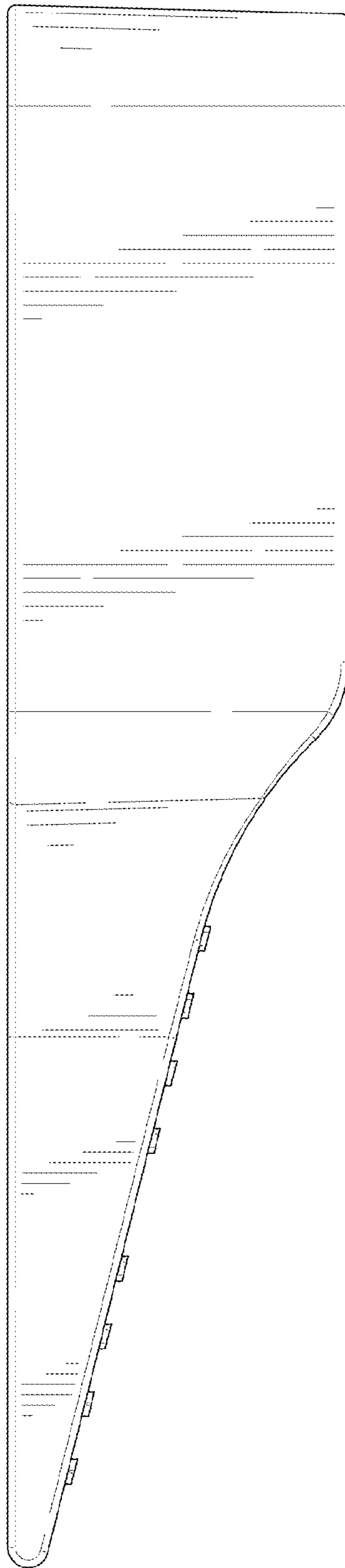

FIG. 5

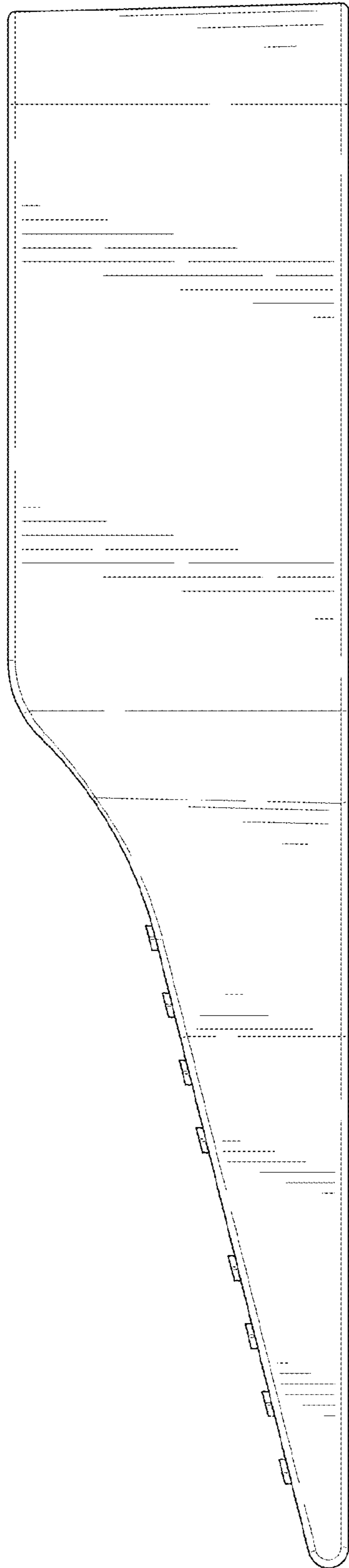

FIG. 6

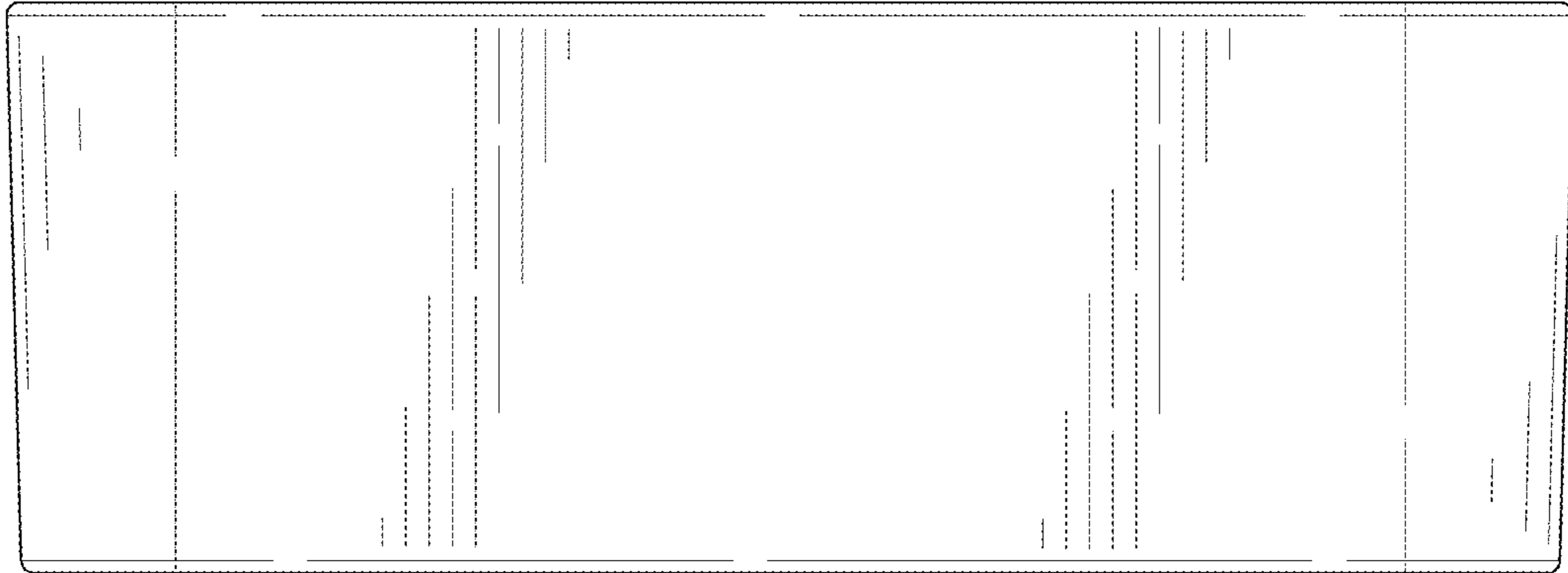

FIG. 7

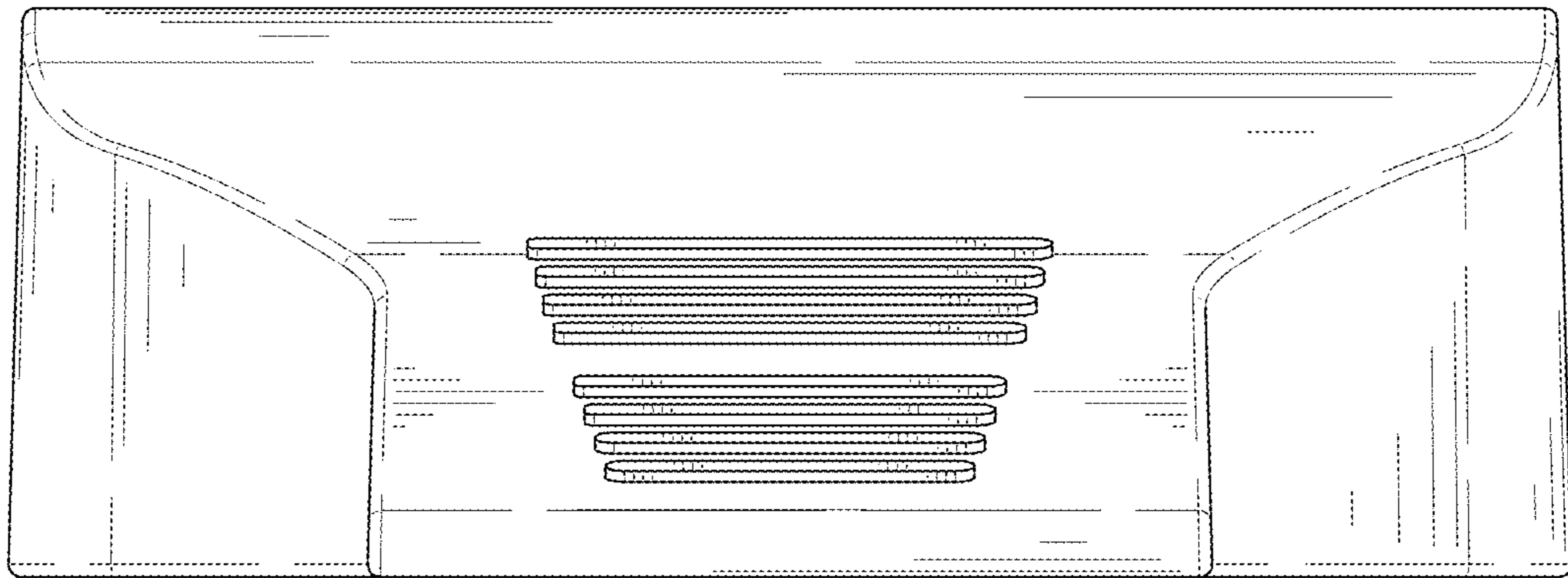

FIG. 8