



US00D973467S

(12) **United States Design Patent** (10) **Patent No.:** **US D973,467 S**  
**Lee et al.** (45) **Date of Patent:** **\*\* \*Dec. 27, 2022**

(54) **ELECTRIC OUTLET COVER**  
(71) Applicant: **IPETIT CO., LTD.**, Yongin-si (KR)  
(72) Inventors: **Ji A Lee**, Seongnam-si (KR); **Yoon Joo Lee**, Seongnam-si (KR)  
(73) Assignee: **IPETIT CO., LTD.**, Yongin-si (KR)  
(\* ) Notice: This patent is subject to a terminal disclaimer.  
(\*\* ) Term: **15 Years**  
(21) Appl. No.: **29/762,223**

D493,695 S \* 8/2004 Wengrower ..... D13/177  
D502,385 S \* 3/2005 Underhill ..... D8/350  
D508,198 S \* 8/2005 Holger ..... D8/353  
D511,675 S \* 11/2005 Holger ..... D8/353  
D522,353 S \* 6/2006 Wengrower ..... D8/352  
D540,655 S \* 4/2007 Fabrizi ..... D8/353  
D541,137 S \* 4/2007 Fabrizi ..... D8/353  
D543,091 S \* 5/2007 Ellbogen ..... D8/353  
D567,633 S \* 4/2008 Anderson ..... D8/353  
D604,147 S \* 11/2009 Sinisi ..... D8/351  
D637,890 S \* 5/2011 Tschirpke ..... D8/353  
D640,526 S \* 6/2011 Cash ..... D8/352  
7,960,651 B2 \* 6/2011 Alderson ..... H02G 3/14  
174/66  
D714,617 S \* 10/2014 Miller ..... D8/350  
D730,158 S \* 5/2015 Miller ..... D8/350

(Continued)

(22) Filed: **Dec. 15, 2020**  
(30) **Foreign Application Priority Data**  
Jun. 15, 2020 (KR) ..... 30-2020-0026711  
(51) **LOC (13) Cl.** ..... **11-05**  
(52) **U.S. Cl.**  
USPC ..... **D8/353**  
(58) **Field of Classification Search**  
USPC .... D8/16, 19, 350-353, 364, 366, 499, 380,  
D8/381; D13/125, 169, 170, 177, 103,  
D13/137.1-137.3, 138.2, 139.1, 139.3,  
D13/139.8  
CPC ..... H02G 3/14; H02G 3/081; H01R 31/06;  
H01R 13/447; H01R 13/717; H01H 9/16;  
H01H 9/18; H01H 23/04; H05B 37/0227;  
H05B 37/0218; H05B 33/0803  
See application file for complete search history.

*Primary Examiner* — Mark A Goodwin  
(74) *Attorney, Agent, or Firm* — Novick, Kim & Lee  
PLLC; Jae Youn Kim

(57) **CLAIM**  
We claim the ornamental design for an electric outlet cover,  
as shown and described.

**DESCRIPTION**  
FIG. 1 is a perspective view of an electric outlet cover,  
showing our new design;  
FIG. 2 is a front elevational view thereof;  
FIG. 3 is a rear elevational view thereof;  
FIG. 4 is a left side elevational view thereof;  
FIG. 5 is a right side elevational view thereof;  
FIG. 6 is a top plan view thereof;  
FIG. 7 is a bottom plan view thereof;  
FIG. 8 is an enlarged partial cross-sectional view thereof,  
taken along line 8-8 in FIG. 2; and,  
FIG. 9 is an enlarged partial cross-sectional view thereof,  
taken along line 9-9 in FIG. 2.

The broken lines in the drawings show portions of the  
electric outlet cover that form no part of the claimed design.

**1 Claim, 7 Drawing Sheets**

(56) **References Cited**  
U.S. PATENT DOCUMENTS  
D379,453 S \* 5/1997 Fabrizi ..... D13/156  
D399,495 S \* 10/1998 Bachschmid ..... D13/177  
D407,072 S \* 3/1999 Gaule ..... D13/177  
D430,478 S \* 9/2000 De brey ..... D8/353

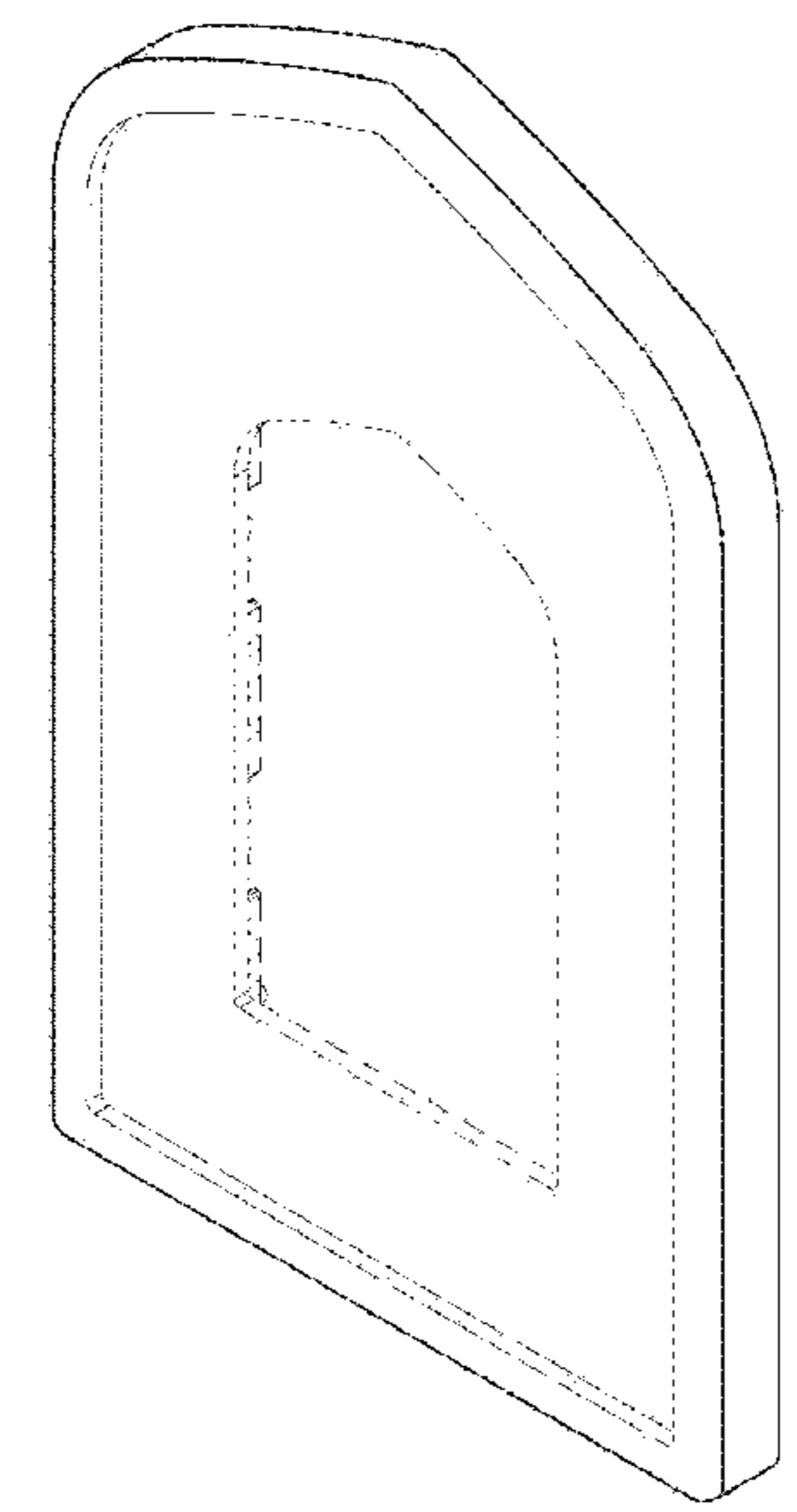

(56)

**References Cited**

U.S. PATENT DOCUMENTS

D845,108 S	*	4/2019	Knight	.....	D8/353
D849,512 S	*	5/2019	Knight	.....	D8/353
D877,599 S	*	3/2020	Knight	.....	D8/353

\* cited by examiner

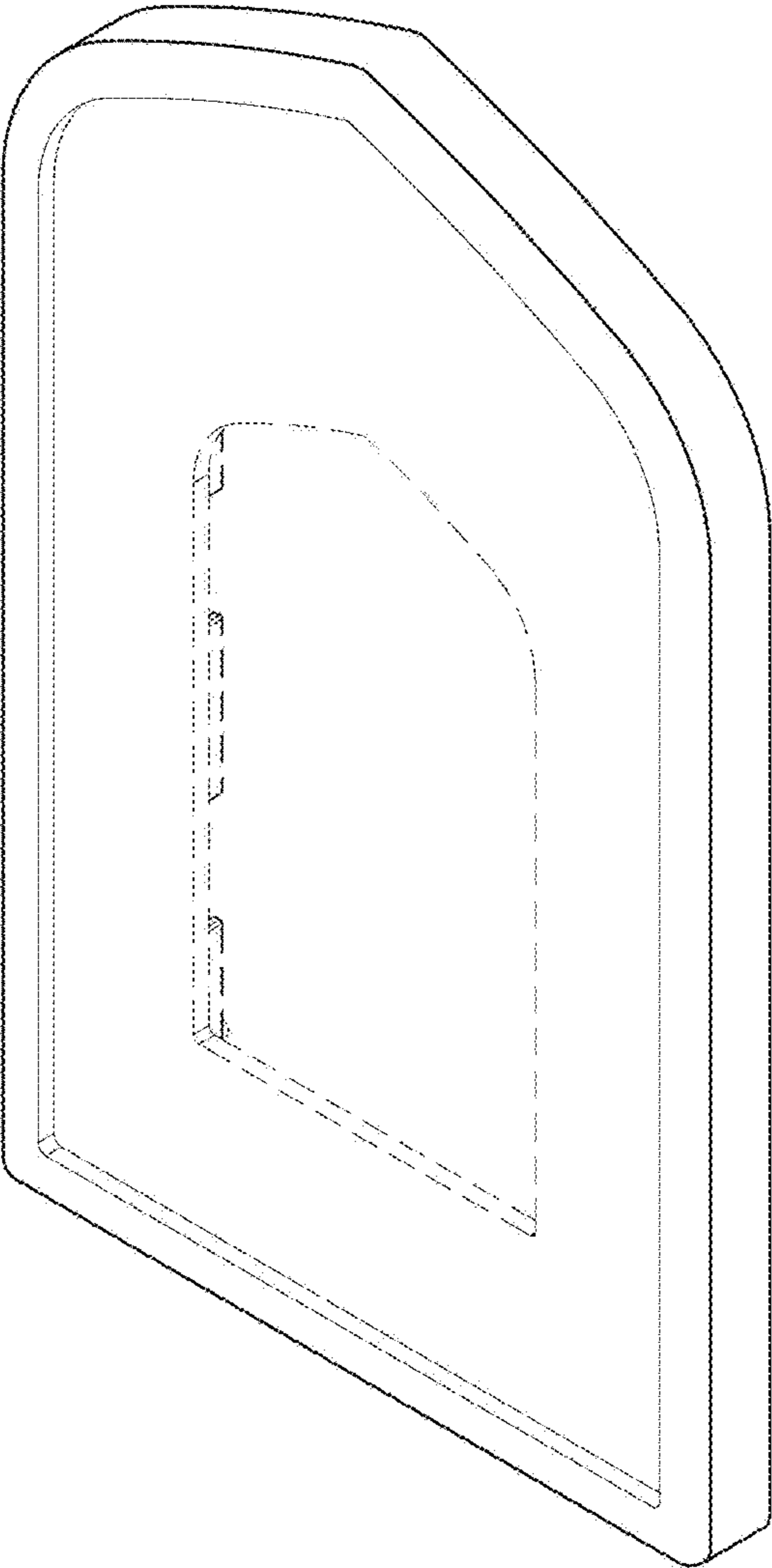

FIG. 1

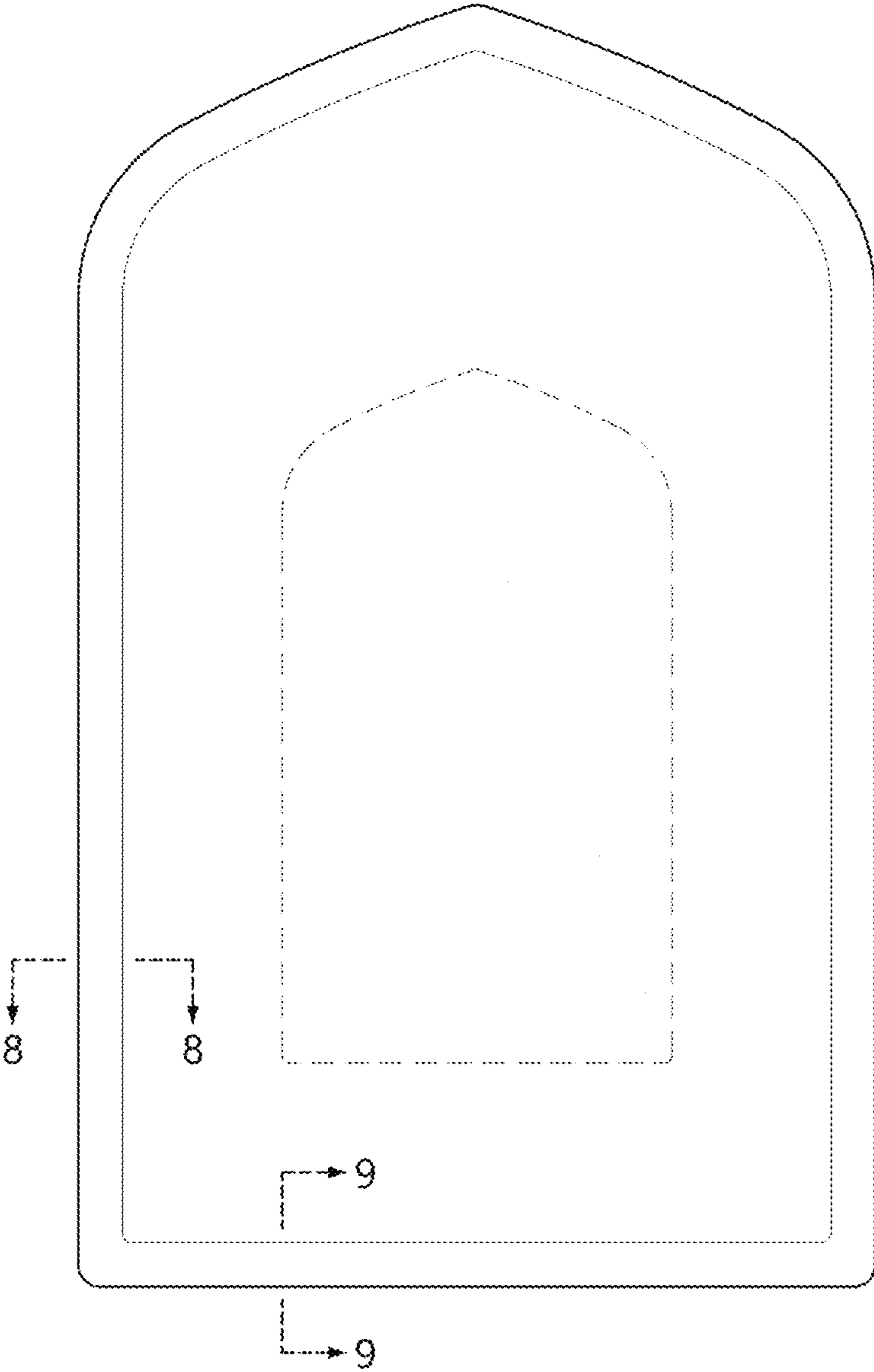

FIG. 2

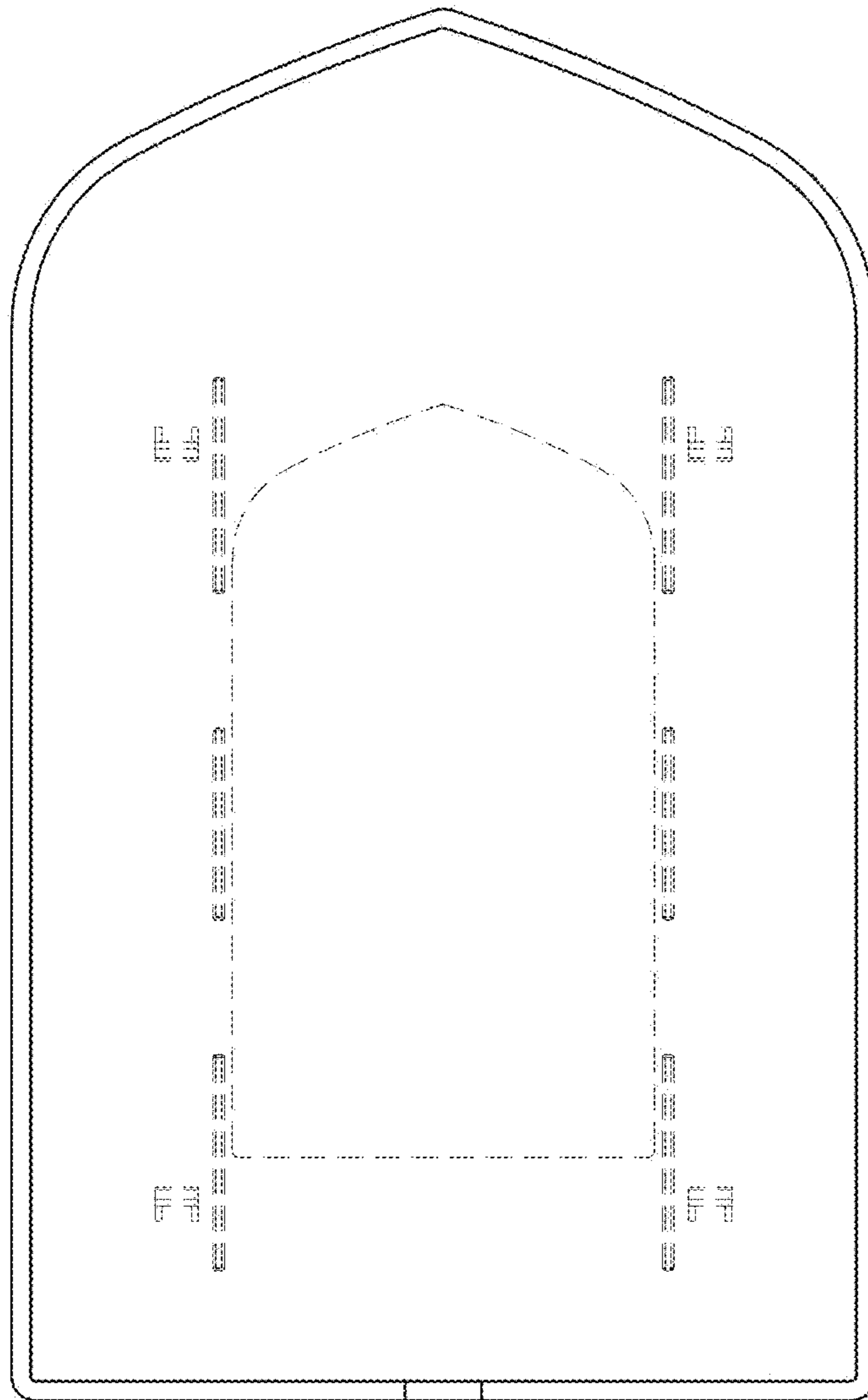

FIG. 3



**FIG. 4**



**FIG. 5**



**FIG. 6**

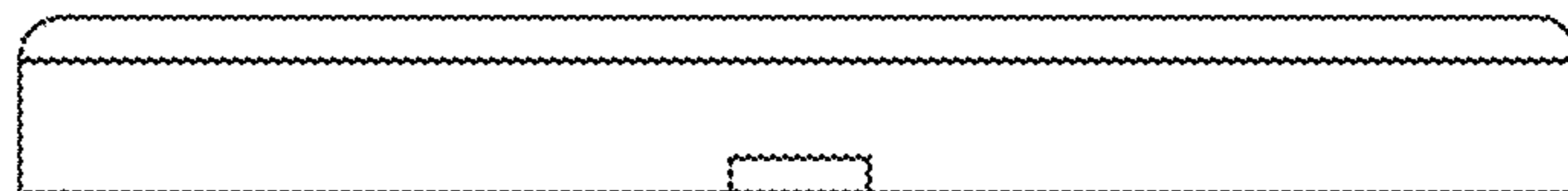

**FIG. 7**



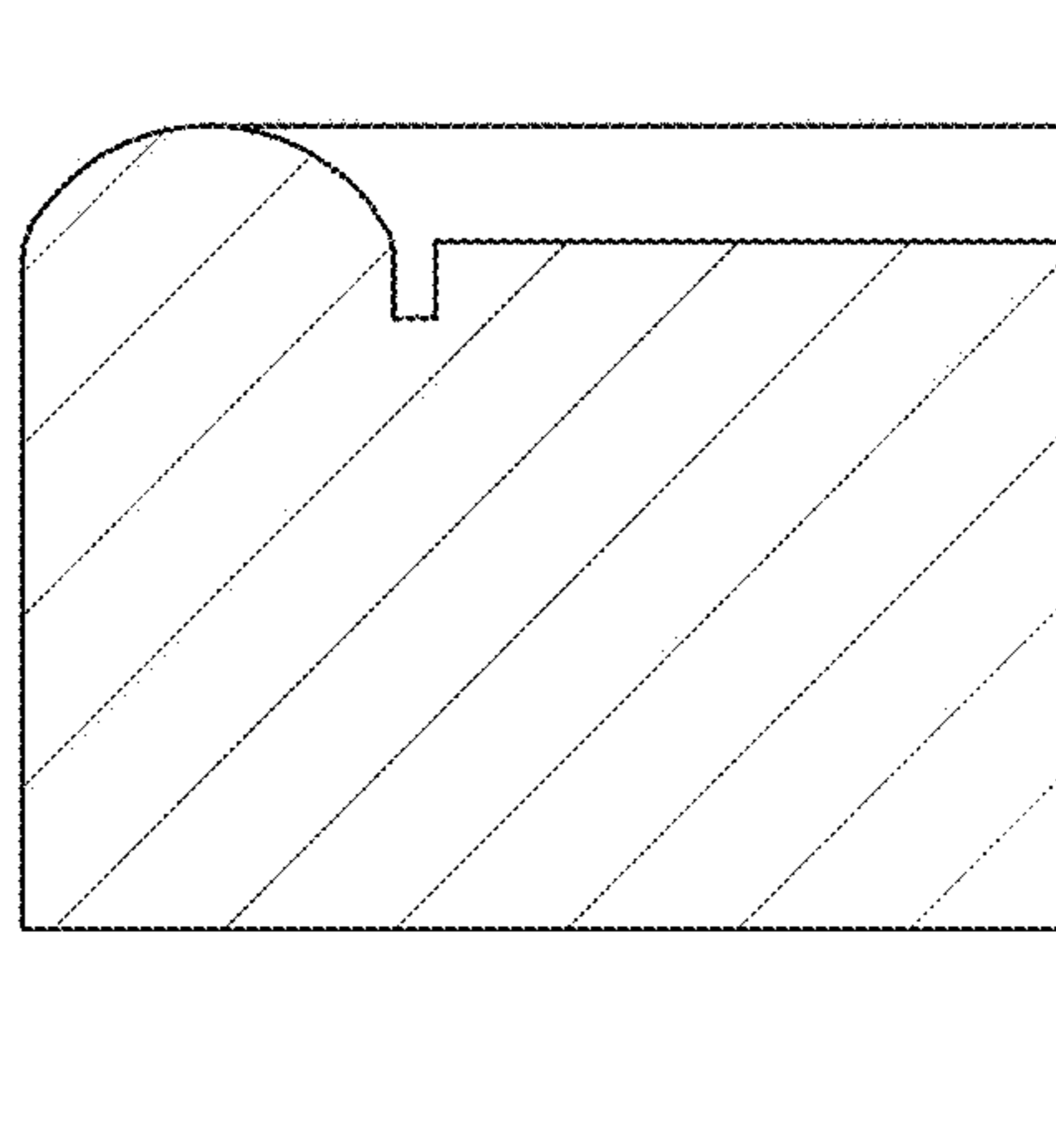

FIG. 8

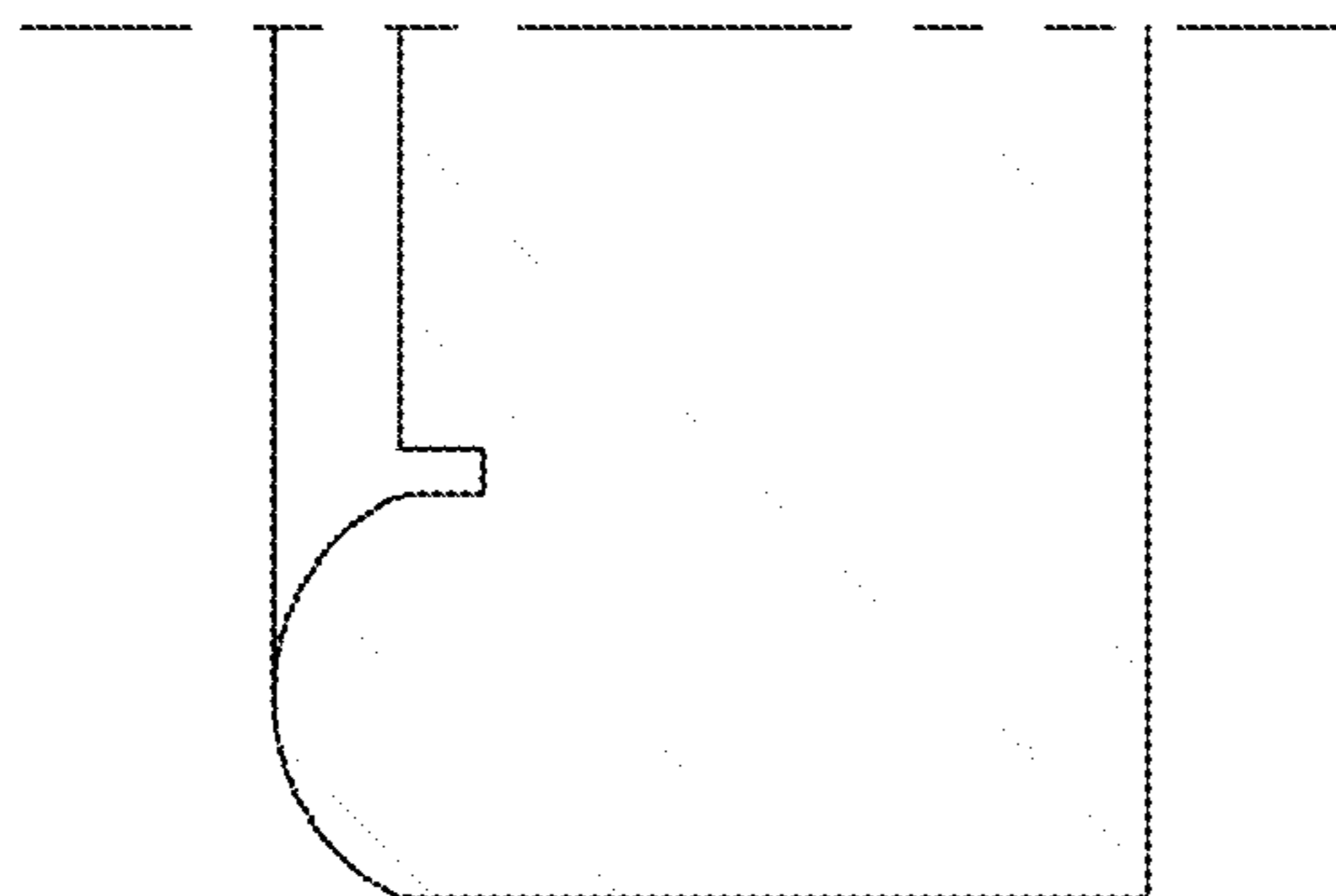

FIG. 9