



US00D973464S

(12) **United States Design Patent** (10) **Patent No.:** **US D973,464 S**
Lee et al. (45) **Date of Patent:** **** *Dec. 27, 2022**

(54) **ELECTRIC OUTLET COVER**
(71) Applicant: **IPETIT CO., LTD.**, Yongin-si (KR)
(72) Inventors: **Ji A Lee**, Seongnam-si (KR); **Yoon Joo Lee**, Seongnam-si (KR)
(73) Assignee: **IPETIT CO., LTD.**, Yongin-si (KR)
(*) Notice: This patent is subject to a terminal disclaimer.
(**) Term: **15 Years**
(21) Appl. No.: **29/762,210**

D493,695 S * 8/2004 Wengrower D13/177
D502,385 S * 3/2005 Underhill D8/350
D508,198 S * 8/2005 Holger D8/353
D511,675 S * 11/2005 Holger D8/353
D522,353 S * 6/2006 Wengrower D8/352
D540,655 S * 4/2007 Fabrizi D8/353
D541,137 S * 4/2007 Fabrizi D8/353
D543,091 S * 5/2007 Ellbogen D8/353
D567,633 S * 4/2008 Anderson D8/353
D604,147 S * 11/2009 Sinisi D8/351
D637,890 S * 5/2011 Tschirpke D8/353
D640,526 S * 6/2011 Cash D8/352
7,960,651 B2 * 6/2011 Alderson H02G 3/14
174/66
D714,617 S * 10/2014 Miller D8/350
D730,158 S * 5/2015 Miller D8/350

(Continued)

(22) Filed: **Dec. 15, 2020**
(30) **Foreign Application Priority Data**
Jun. 15, 2020 (KR) 30-2020-0026700
(51) **LOC (13) Cl.** **11-05**
(52) **U.S. Cl.**
USPC **D8/353**
(58) **Field of Classification Search**
USPC D8/16, 19, 350-353, 364, 366, 499, 380,
D8/381; D13/125, 169, 170, 177, 103,
D13/137.1-137.3, 138.2, 139.1, 139.3,
D13/139.8
CPC H02G 3/14; H02G 3/081; H01R 31/06;
H01R 13/447; H01R 13/717; H01H 9/16;
H01H 9/18; H01H 23/04; H05B 37/0227;
H05B 37/0218; H05B 33/0803
See application file for complete search history.

Primary Examiner — Mark A Goodwin
(74) *Attorney, Agent, or Firm* — Novick, Kim & Lee
PLLC; Jae Youn Kim

(57) **CLAIM**
We claim the ornamental design for an electric outlet cover,
as shown and described.

DESCRIPTION
FIG. 1 is a perspective view of an electric outlet cover,
showing our new design;
FIG. 2 is a front elevational view thereof;
FIG. 3 is a rear elevational view thereof;
FIG. 4 is a left side elevational view thereof;
FIG. 5 is a right side elevational view thereof;
FIG. 6 is a top plan view thereof;
FIG. 7 is a bottom plan view thereof;
FIG. 8 is an enlarged partial cross-sectional view thereof,
taken along line 8-8 in FIG. 2; and,
FIG. 9 is an enlarged partial cross-sectional view thereof,
taken along line 9-9 in FIG. 2.

The broken lines in the drawings show portions of the
electric outlet cover that form no part of the claimed design.

1 Claim, 7 Drawing Sheets

(56) **References Cited**
U.S. PATENT DOCUMENTS
D379,453 S * 5/1997 Fabrizi D13/156
D399,495 S * 10/1998 Bachschmid D13/177
D407,072 S * 3/1999 Gaule D13/177
D430,478 S * 9/2000 De brey D8/353

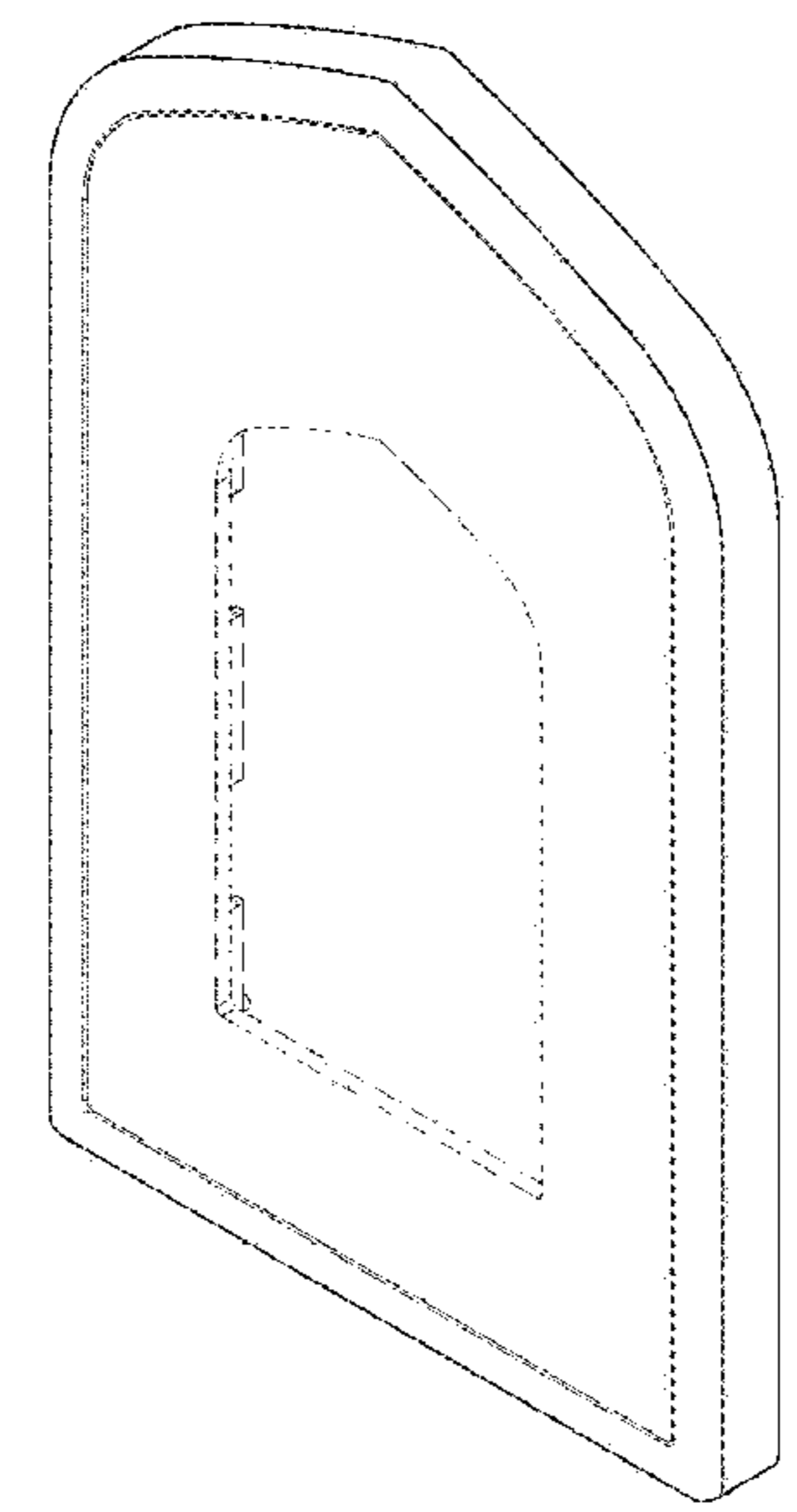

(56)

References Cited

U.S. PATENT DOCUMENTS

D845,108 S	*	4/2019	Knight	D8/353
D849,512 S	*	5/2019	Knight	D8/353
D877,599 S	*	3/2020	Knight	D8/353

* cited by examiner

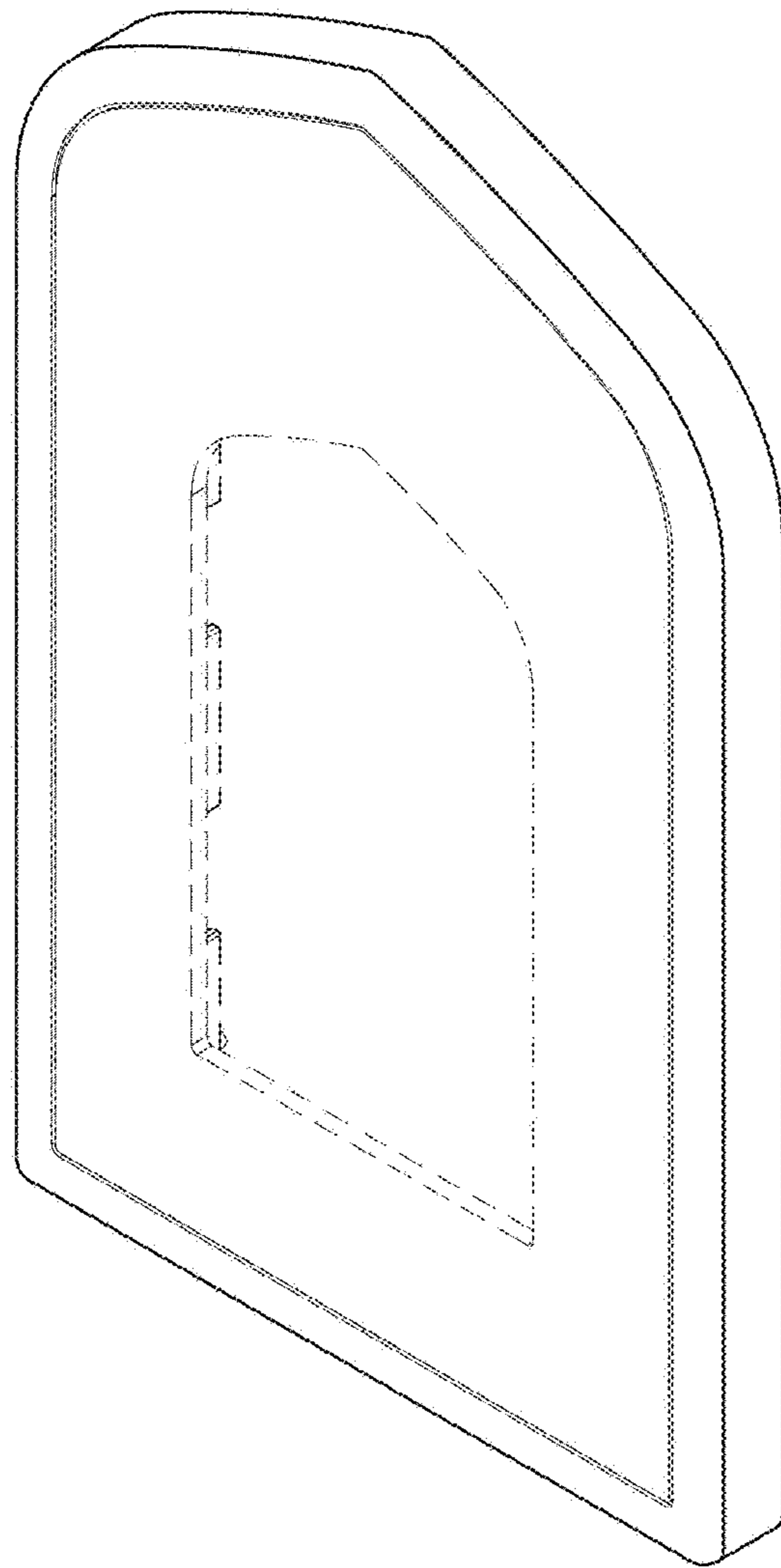

FIG. 1

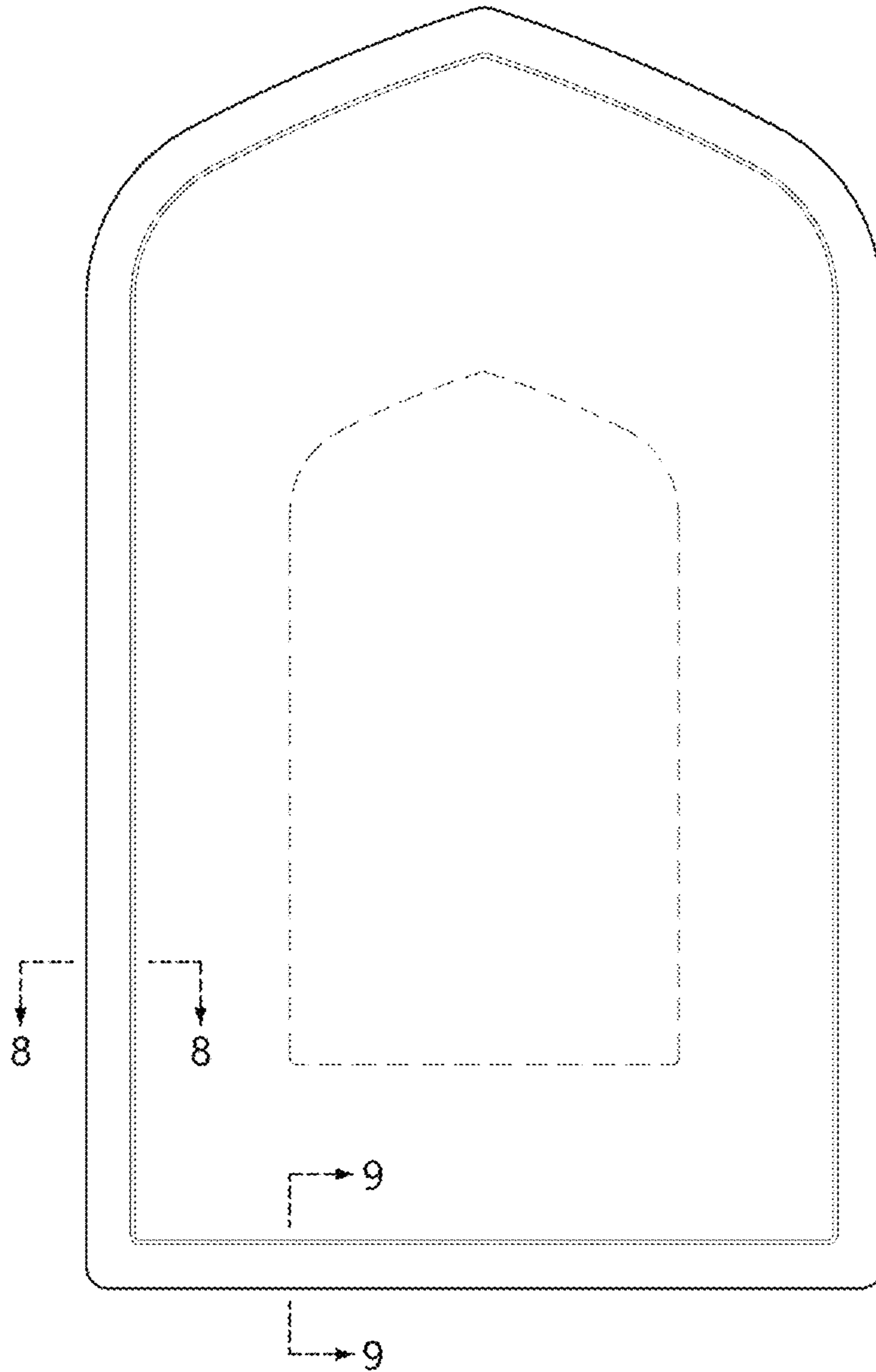

FIG. 2

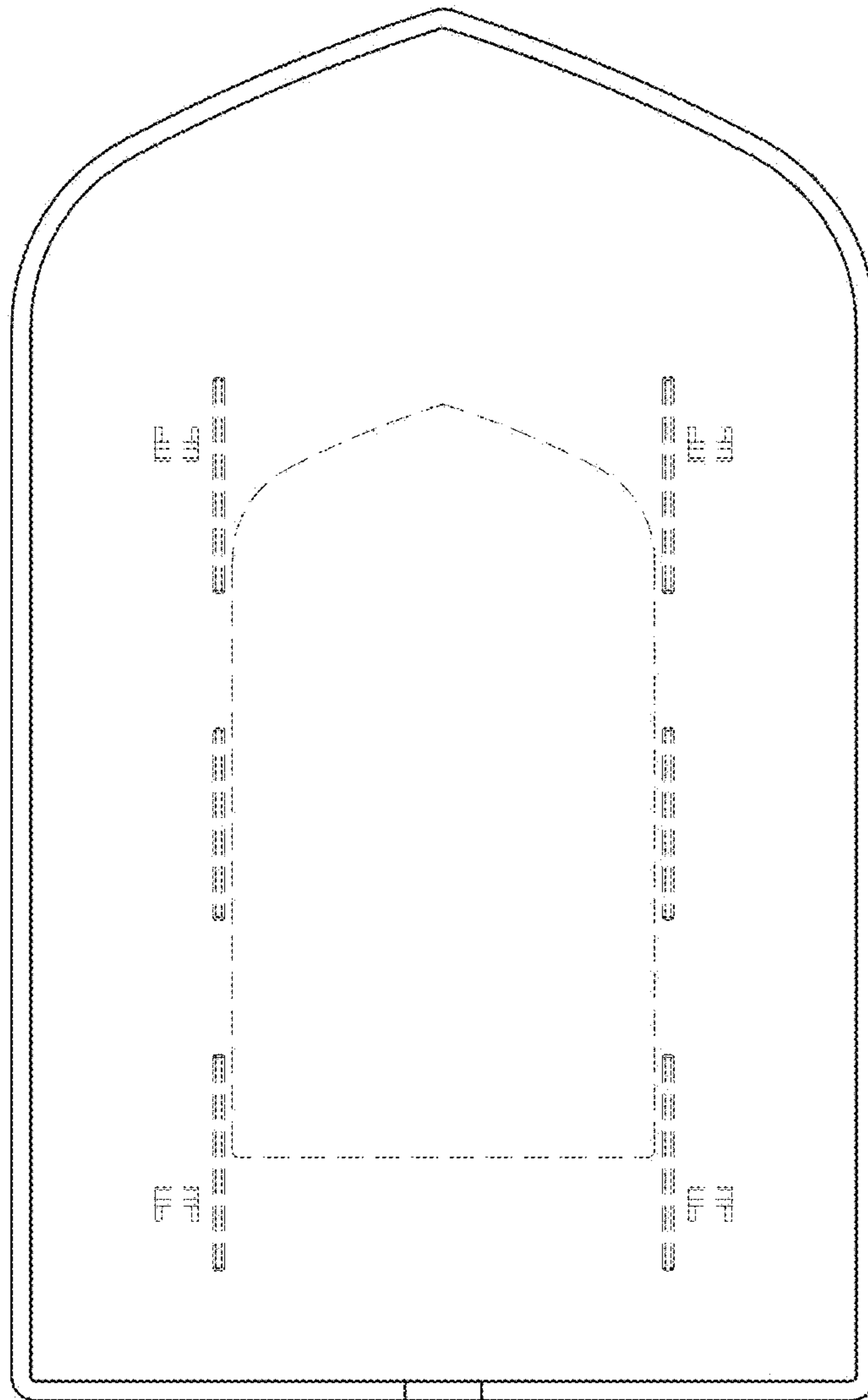

FIG. 3



FIG. 4



FIG. 5



FIG. 6

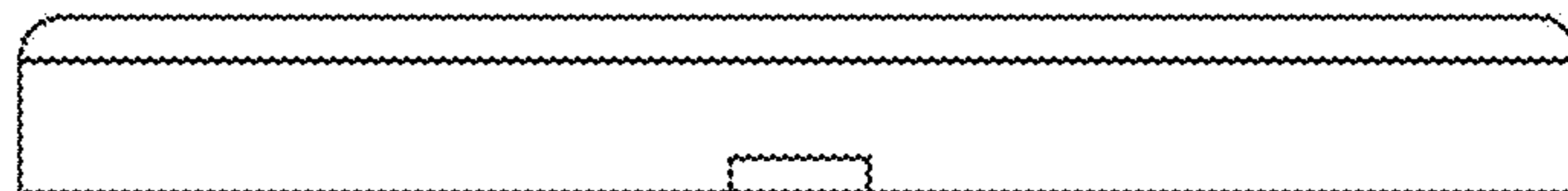

FIG. 7

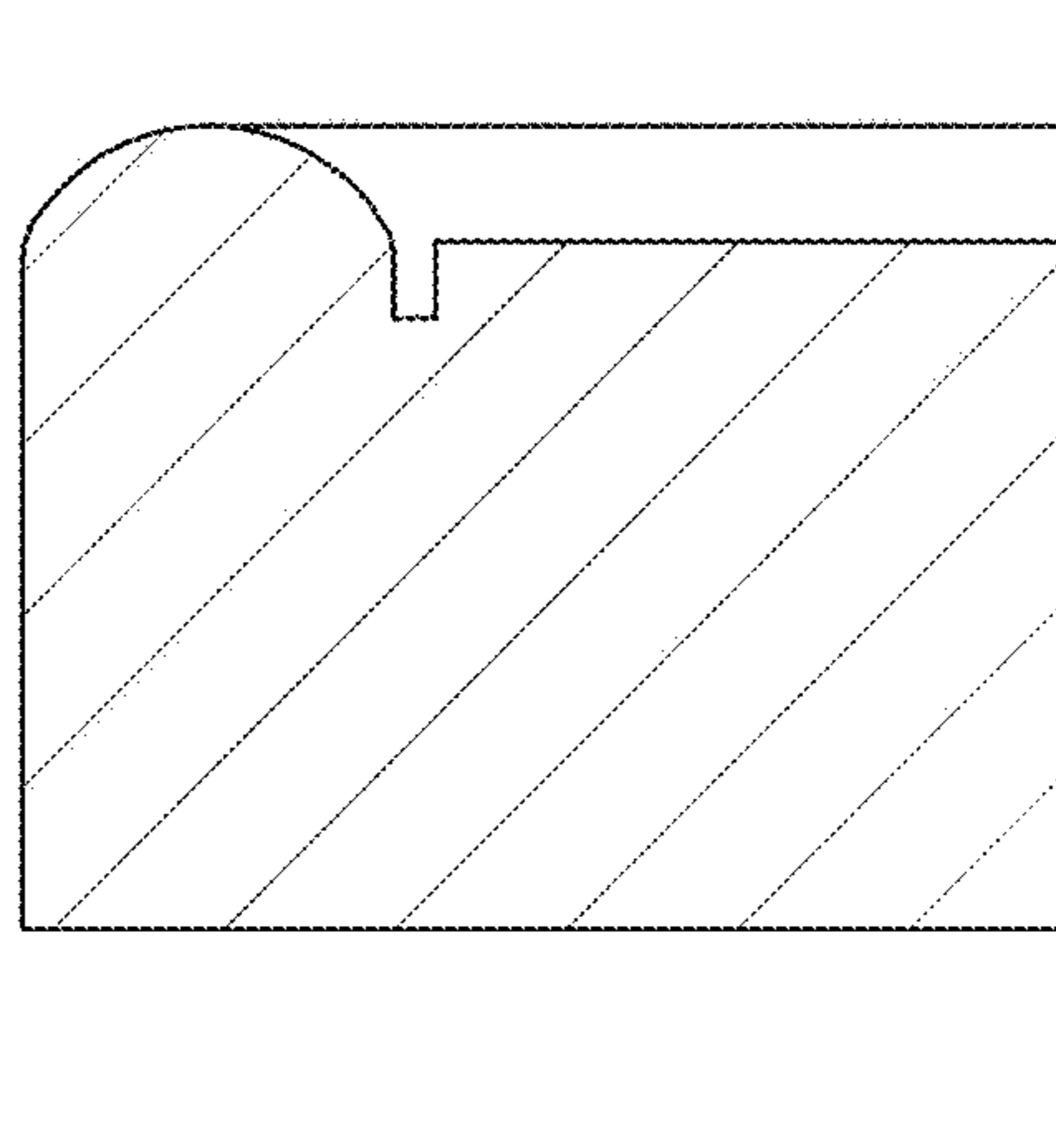

FIG. 8

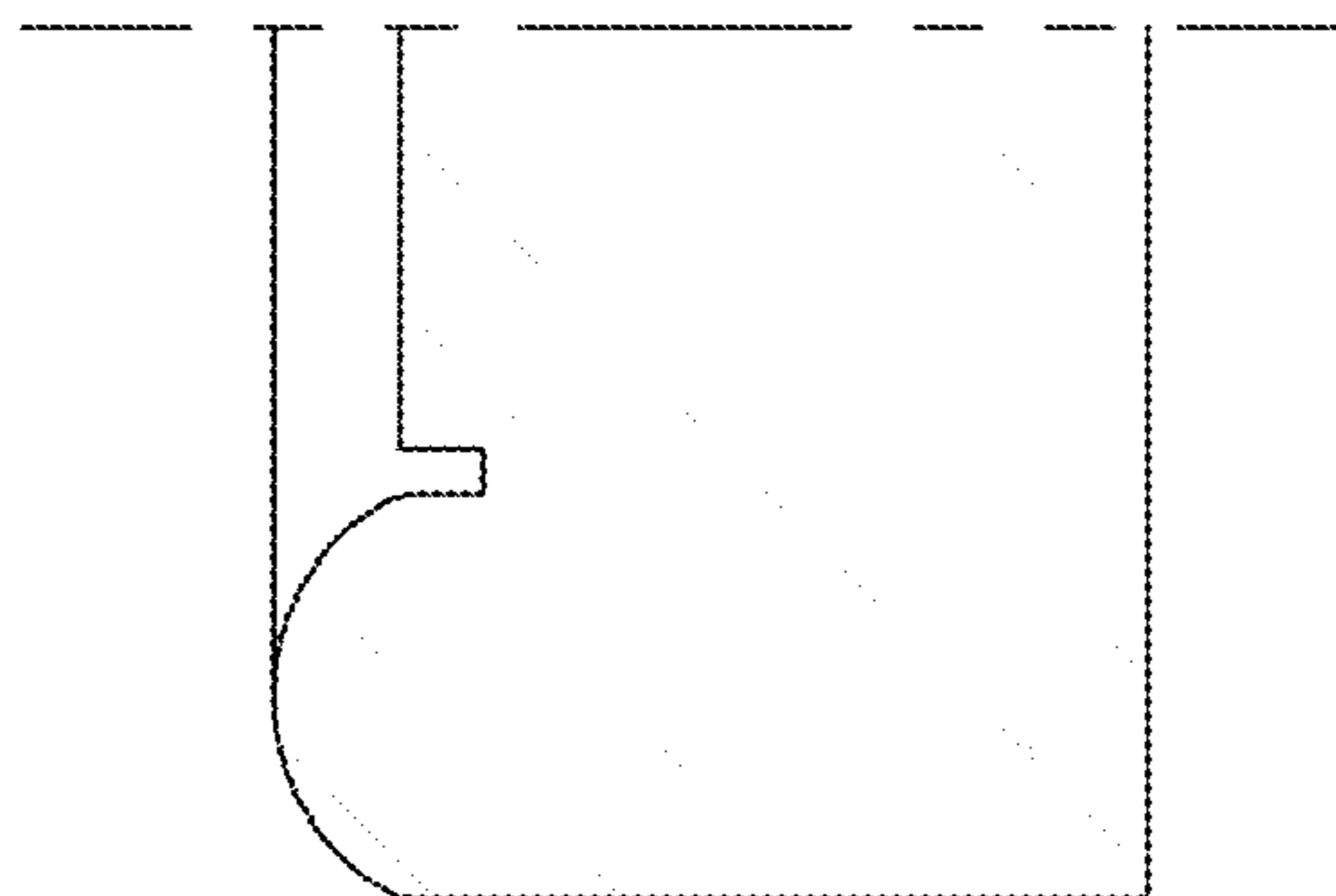

FIG. 9