



US00D973424S

(12) **United States Design Patent** (10) **Patent No.:** **US D973,424 S**
Yu (45) **Date of Patent:** **** Dec. 27, 2022**

(54) **FOOD WASTE DISPOSER**

(71) Applicant: **Cheng-Kang Yu**, Taiwan (CN)

(72) Inventor: **Cheng-Kang Yu**, Taiwan (CN)

(**) Term: **15 Years**

(21) Appl. No.: **29/824,368**

(22) Filed: **Jan. 24, 2022**

(30) **Foreign Application Priority Data**

Nov. 1, 2021 (CN) 202130715013.8

(51) **LOC (13) Cl.** **31-00**

(52) **U.S. Cl.**
USPC **D7/375**

(58) **Field of Classification Search**

USPC D7/354, 355, 360, 372, 375-386,
D7/412-413, 602, 629, 665-666, 669,
D7/679, 693-694; D34/7
CPC A21C 1/02; A21C 1/04; A23N 1/00; A23N
1/02; A47J 43/04; A47J 43/25; A47J
43/27; A47J 43/042; A47J 43/044; A47J
43/046; A47J 43/075; A47J 43/0722;
A47J 43/0727; B01F 3/00; B01F 3/0807;
B01F 3/0853; B01F 13/0059; B01F
13/0064; B01F 13/00; B01F 13/04; B01F
13/06; B01F 13/2804; B02C 1/08; B02C
2/04; B02C 4/42; B02C 4/142; B02C
4/143; B02C 4/423; B02C 13/1835; B02C
18/00; B02C 18/0076; B02C 18/0084;
B02C 18/0092; B02C 2013/2808; B02C
2013/2812; B28C 5/10; B28C 5/12; B28C
5/14; B28C 5/16; E03C 1/26; E03C
1/2665; E03C 1/28; E03C 1/30; E03C
1/302; E03C 1/304; A61L 11/00

See application file for complete search history.

(56) **References Cited**

U.S. PATENT DOCUMENTS

D520,806 S *	5/2006	Ryan	D7/360
D566,457 S *	4/2008	Ryan	D7/360
D577,247 S *	9/2008	Barnes	D7/354
D592,902 S *	5/2009	Currie	D7/355
D667,256 S *	9/2012	Krapfl	D7/354
D684,003 S	6/2013	Bennage et al.		
D684,005 S	6/2013	Mahale et al.		
D711,060 S *	8/2014	Butler	D34/7
D746,100 S	12/2015	Falcone et al.		
D780,505 S	3/2017	Gamble et al.		
D900,422 S *	10/2020	Joseph	D34/7
D909,000 S *	1/2021	Grossman	D34/7

OTHER PUBLICATIONS

OXO Good Grips Easy-Clean Compost Bin. Date First Available on Amazon.com Oct. 21, 2019. <https://www.amazon.com/OXO-Good-Grips-Easy-Clean-Compost/dp/B07ZDRHV3N/ref> (Year: 2019).*

* cited by examiner

Primary Examiner — Ricky Pham

(74) *Attorney, Agent, or Firm* — Jeenam Park

(57) **CLAIM**

The ornamental design for a food waste disposer, as shown and described.

DESCRIPTION

FIG. 1 is a perspective view of a food waste disposer, showing my new design;
FIG. 2 is a front view thereof;
FIG. 3 is a rear view thereof;
FIG. 4 is a left side view thereof;
FIG. 5 is a right side view thereof;
FIG. 6 is a top plan view thereof; and,
FIG. 7 is a bottom plan view thereof.
The broken line showing of the food waste disposer is for the purpose of illustrating article and forms no part of the claimed design.

1 Claim, 7 Drawing Sheets

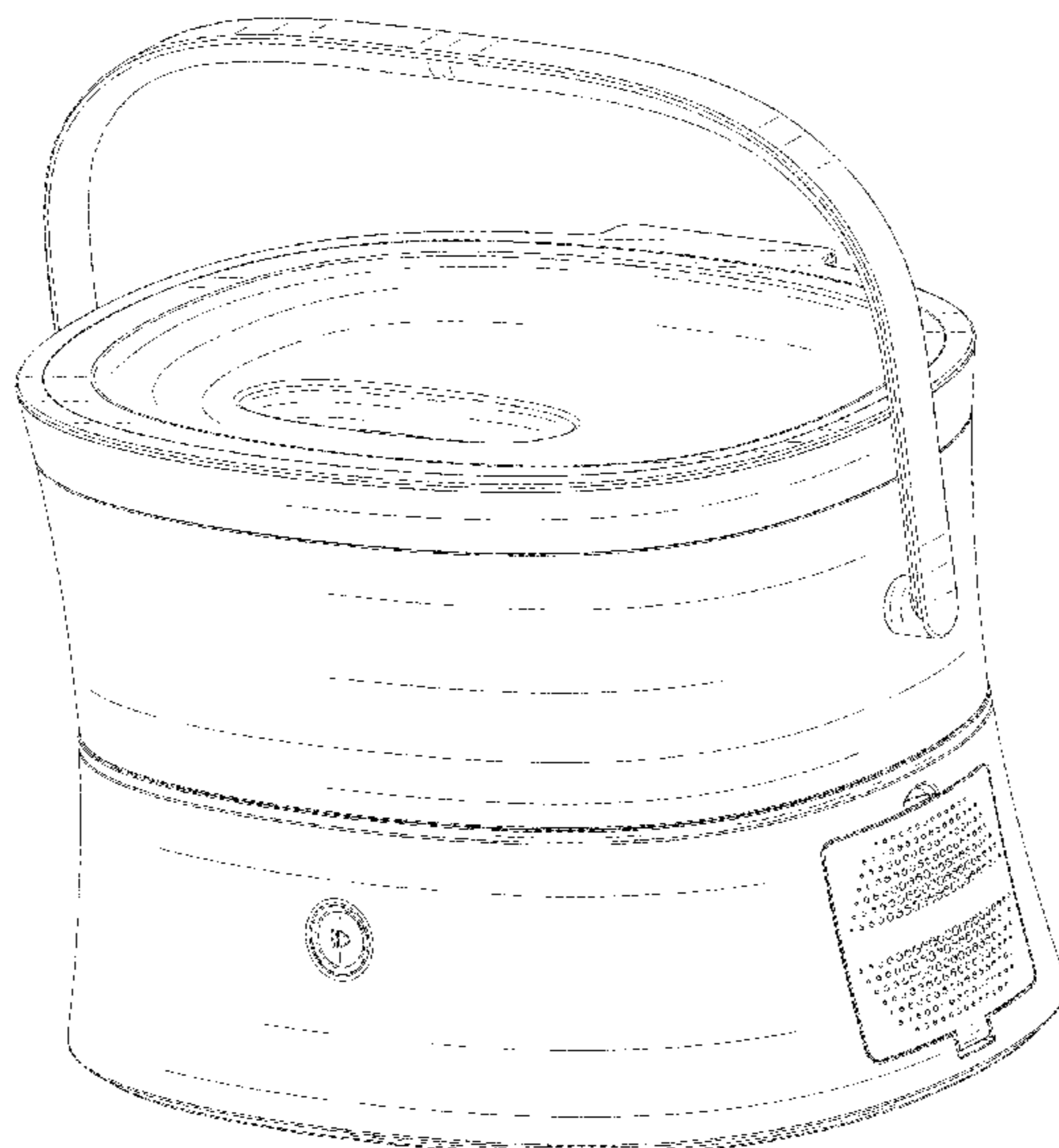

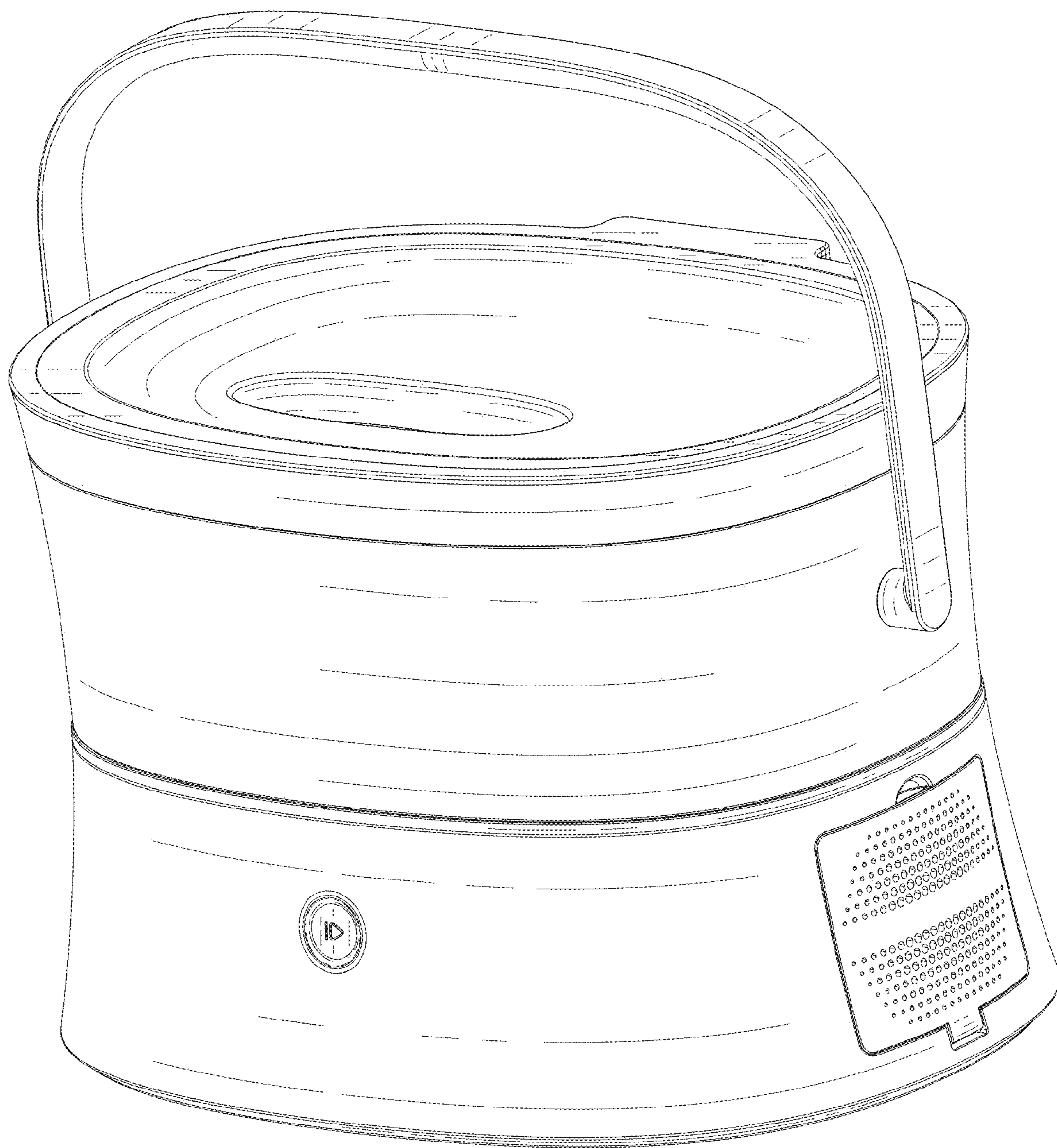

FIG. 1

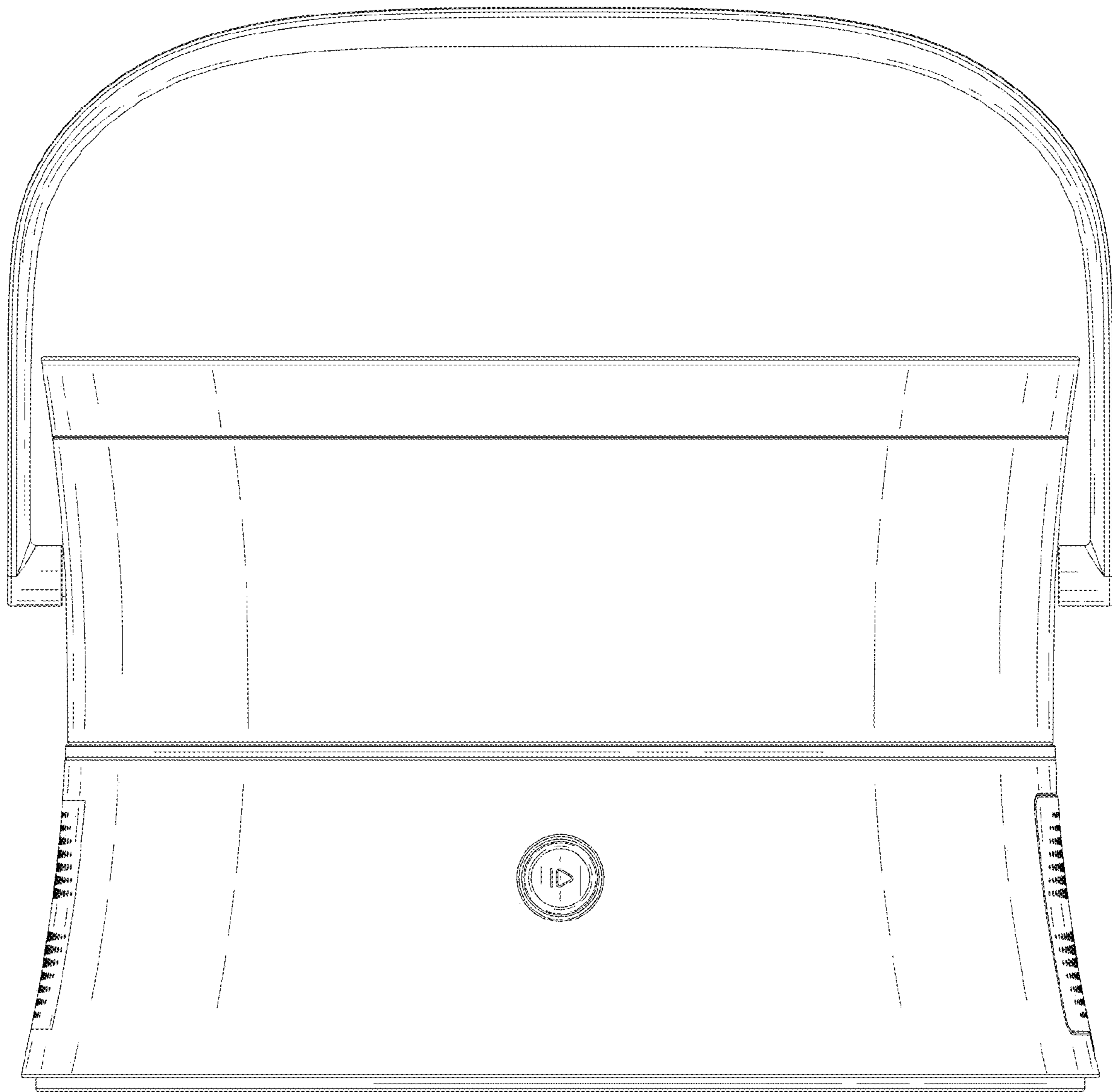

FIG. 2

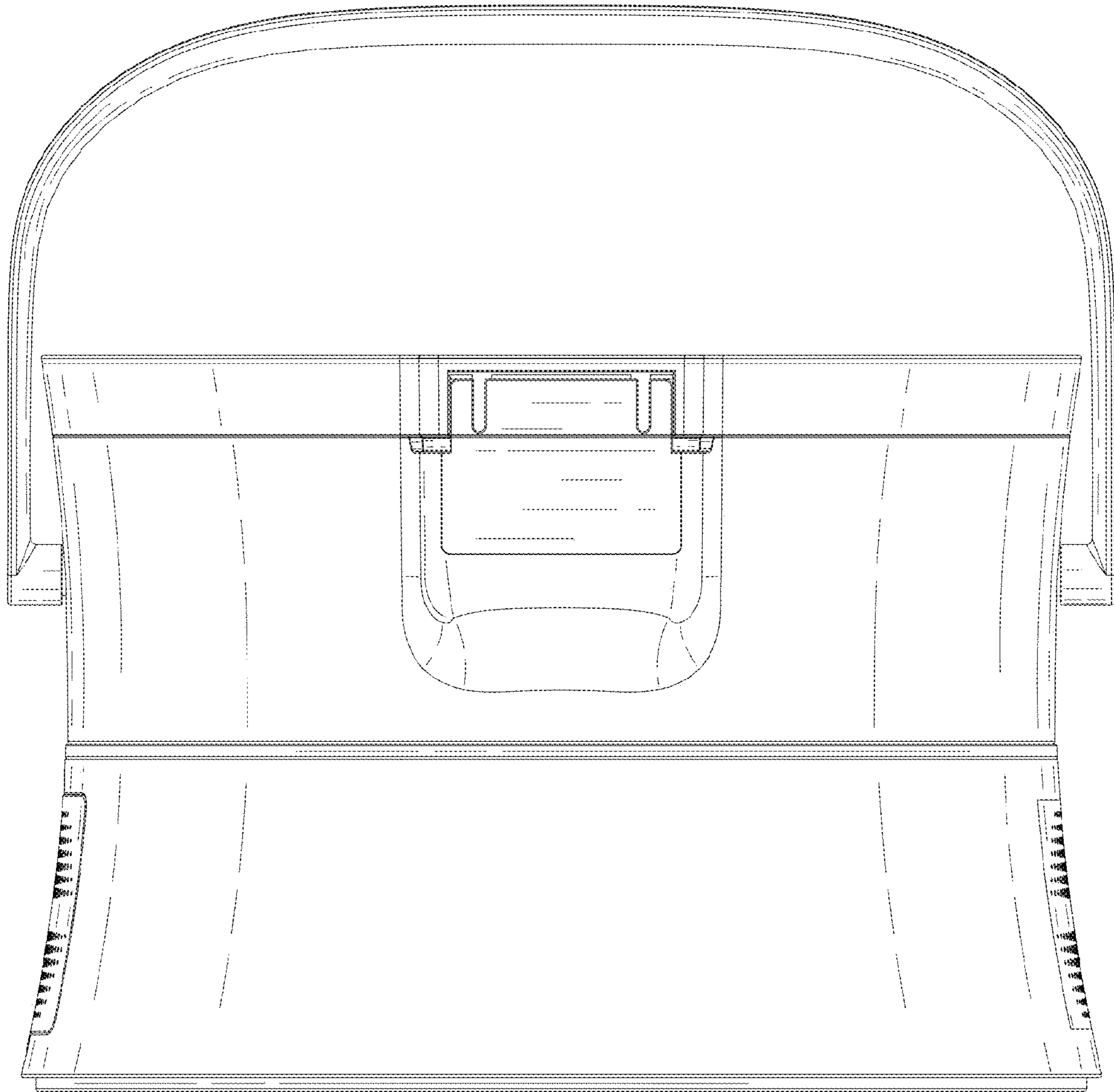

FIG. 3

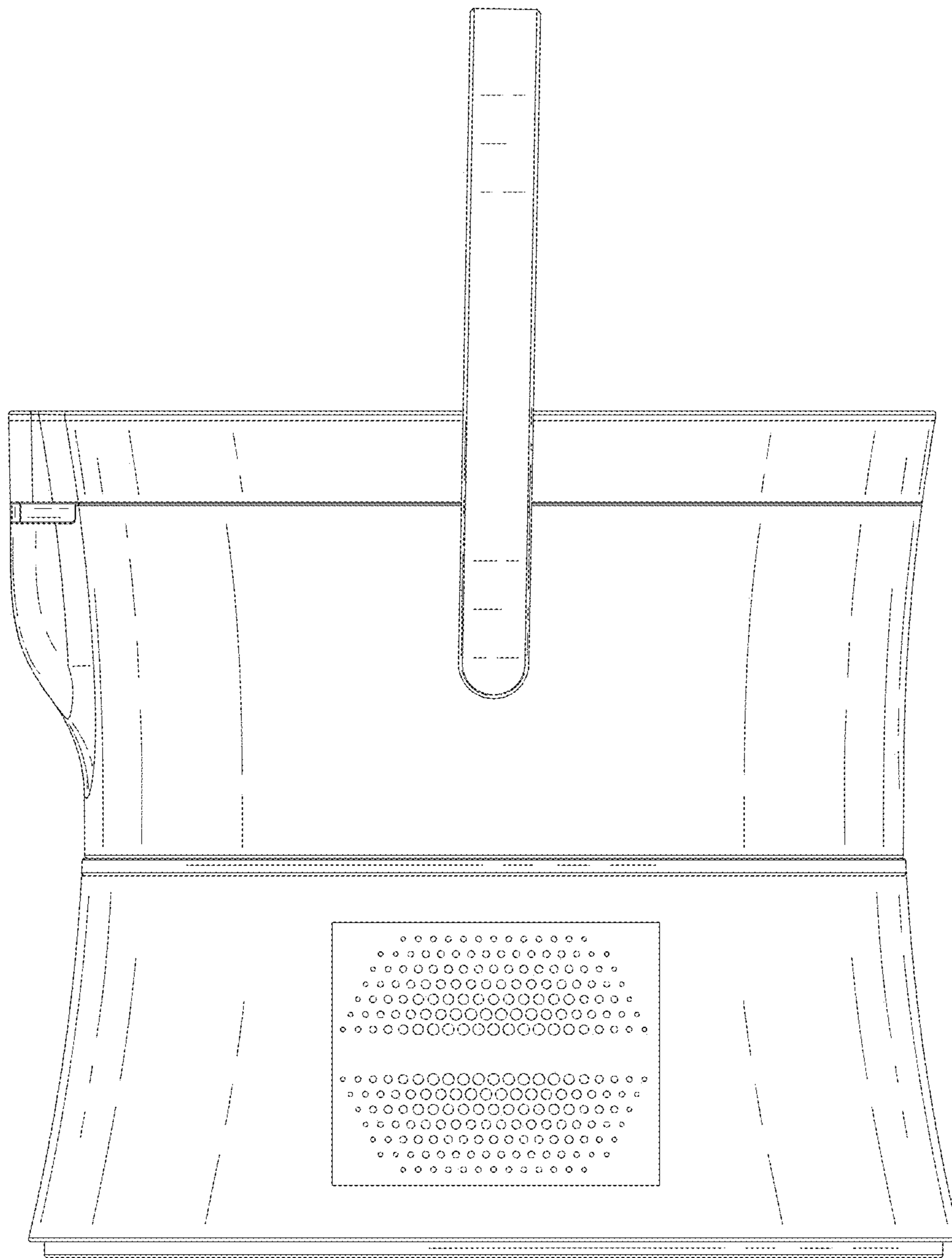

FIG. 4

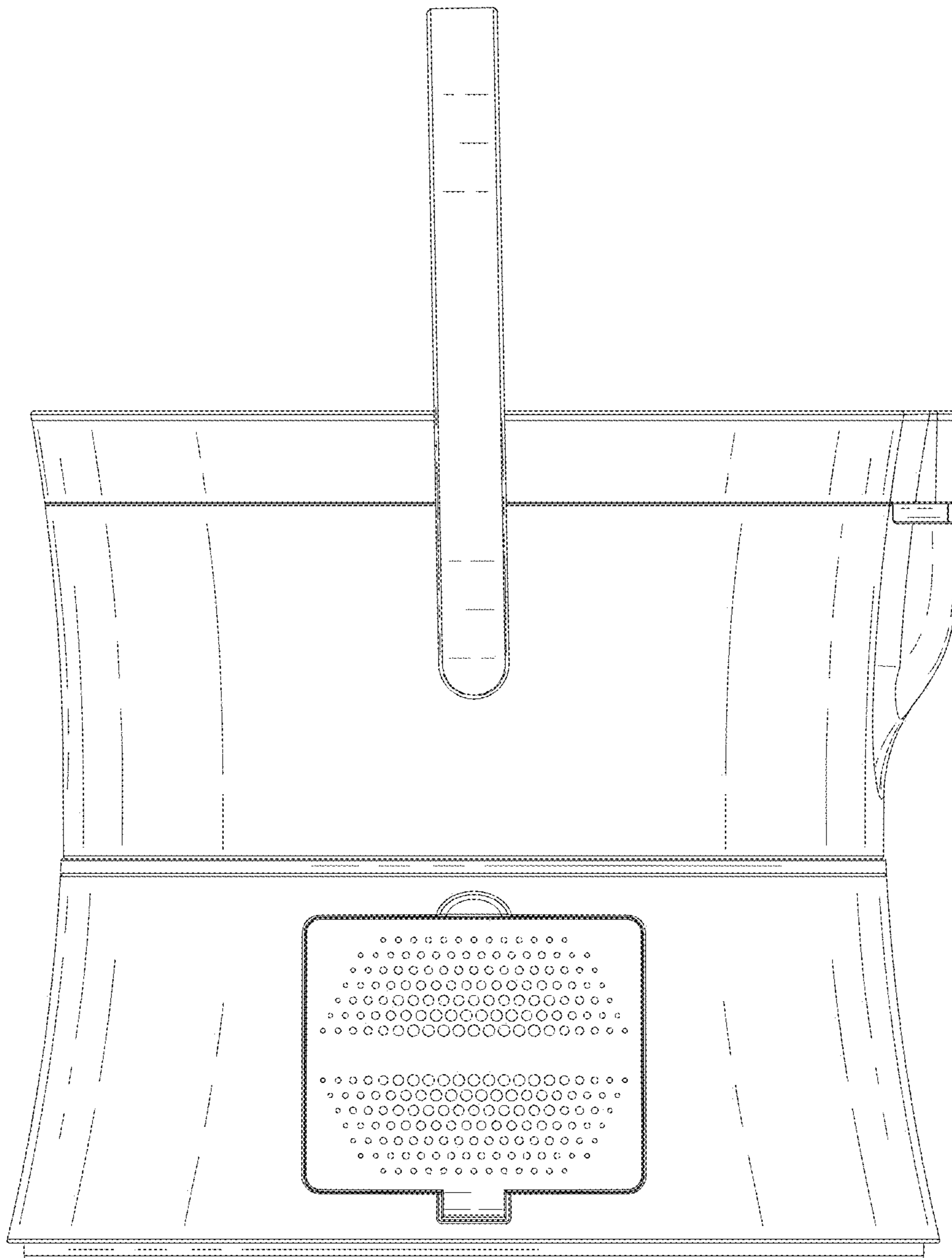

FIG. 5

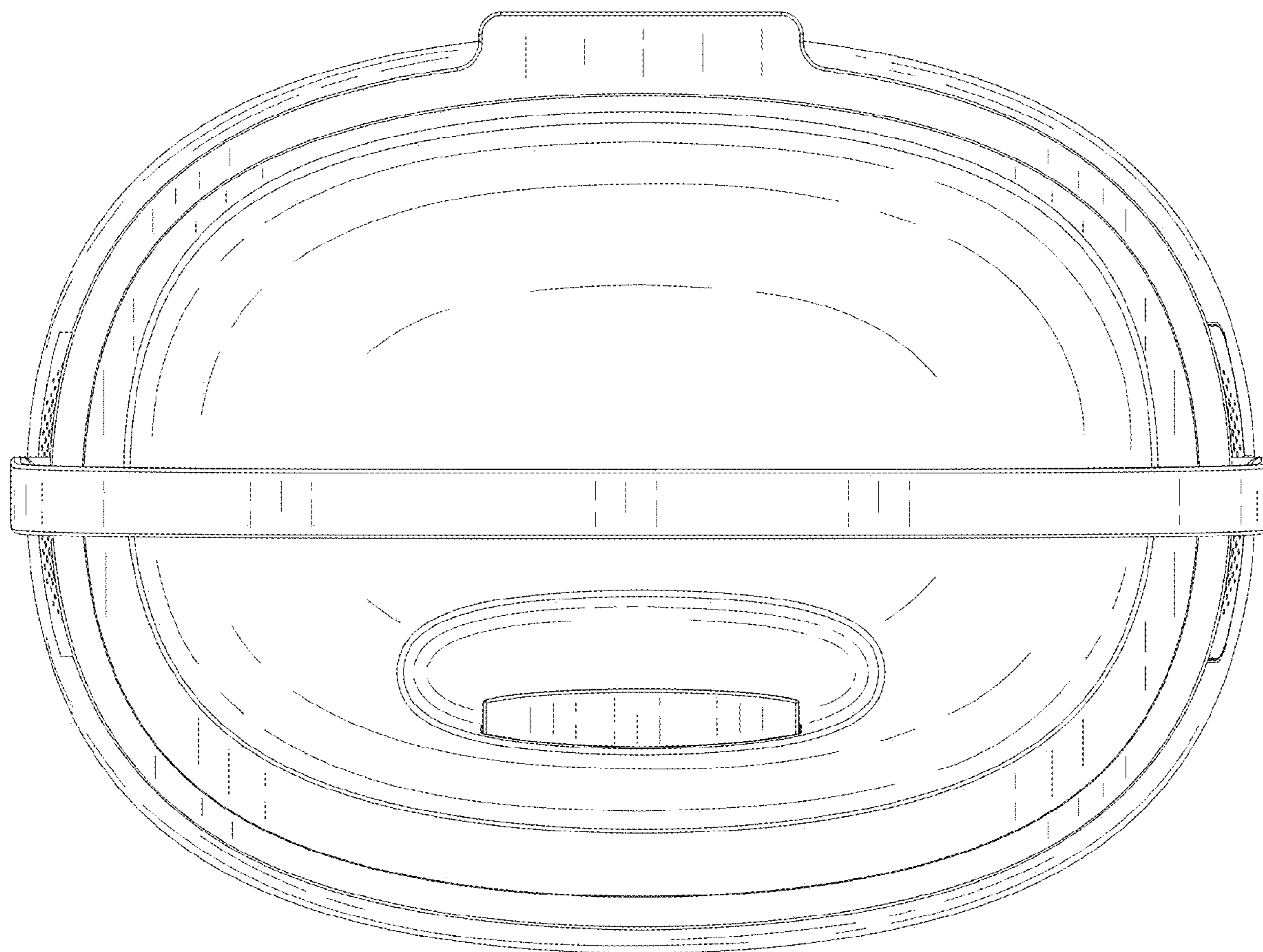

FIG. 6

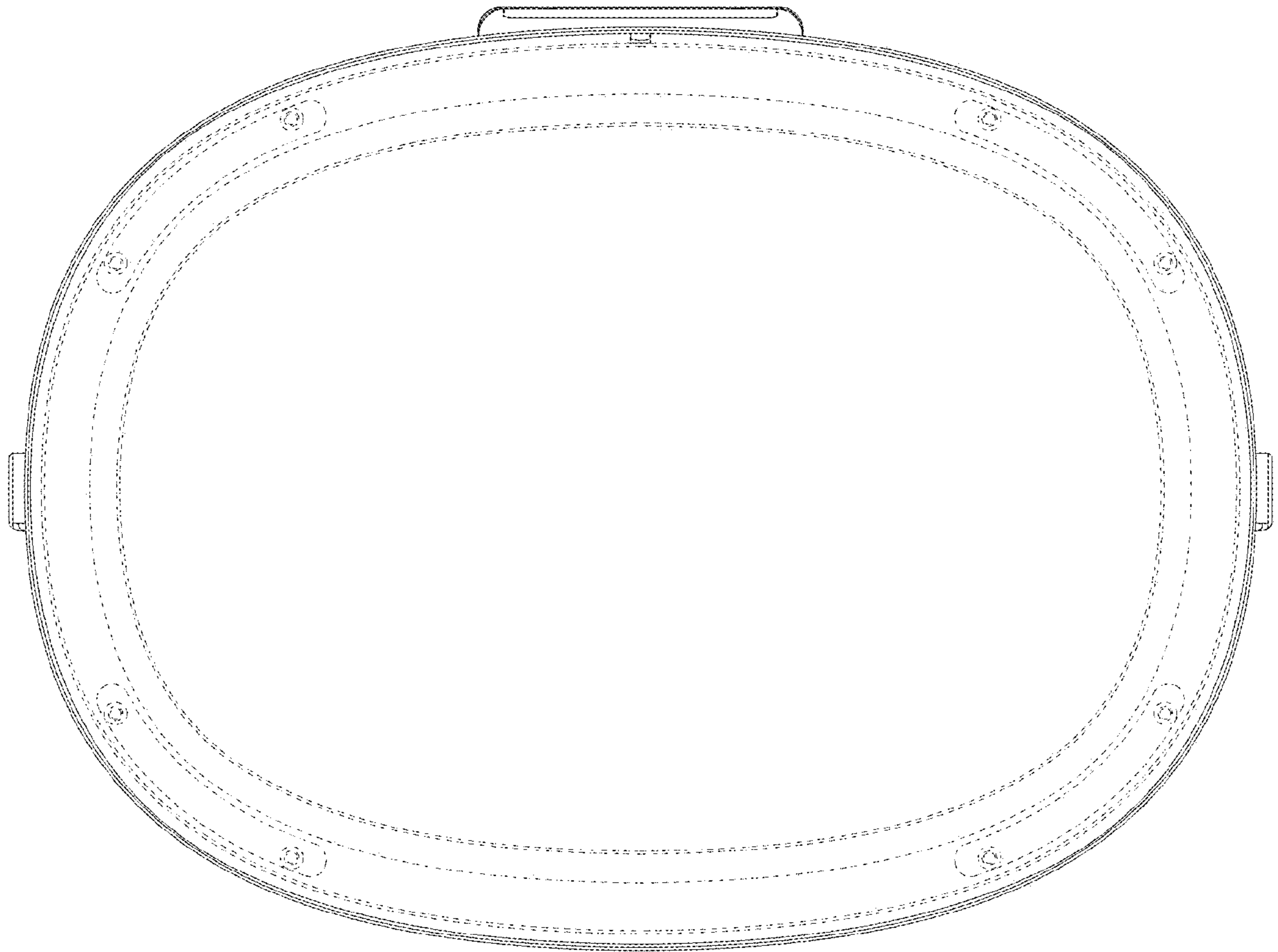

FIG. 7