



US00D973390S

(12) **United States Design Patent** (10) **Patent No.:** **US D973,390 S**
Li (45) **Date of Patent:** **** Dec. 27, 2022**

(54) **SANITIZER DISPENSER**
(71) Applicant: **SHENZHEN JISU TECHNOLOGY CO., LTD**, Shenzhen (CN)
(72) Inventor: **Xiangfu Li**, Shenzhen (CN)
(73) Assignee: **SHENZHEN JISU TECHNOLOGY CO., LTD**, Shenzhen (CN)
(**) Term: **15 Years**

D869,193 S * 12/2019 Peterson D6/542
D869,194 S * 12/2019 Joseph D6/542
D897,721 S * 10/2020 Jia D6/542
D906,723 S * 1/2021 Chen D6/542
D927,885 S * 8/2021 Holzmann D6/542
2021/0322598 A1* 10/2021 Brazer A61L 2/10

FOREIGN PATENT DOCUMENTS

CN 306788048 * 8/2021
GB 6093002 * 6/2020
IN 331309-001-0001 * 7/2020

OTHER PUBLICATIONS

Jisulife Automatic Soap Dispenser. Date first available: Oct. 3, 2021. Site visited: Aug. 3, 2022. Available online: <https://www.ubuy.co.id/en/product/3V949F5GU> (Year: 2021).*

(Continued)

Primary Examiner — Catherine S Posthauer
Assistant Examiner — Joan E. Diehl

(57) **CLAIM**

The ornamental design for a sanitizer dispenser, as shown and described.

DESCRIPTION

FIG. 1 is a perspective view of a sanitizer dispenser showing my new design;
FIG. 2 is another perspective view thereof;
FIG. 3 is a front elevational view thereof;
FIG. 4 is a rear elevational view thereof;
FIG. 5 is a left side elevational view thereof;
FIG. 6 is a right side elevational view thereof;
FIG. 7 is a top plan view thereof; and,
FIG. 8 is a bottom plan view thereof.
The broken lines in the drawings depict portions of the sanitizer dispenser that form no part of the claimed design.

1 Claim, 8 Drawing Sheets

(21) Appl. No.: **29/761,531**
(22) Filed: **Dec. 9, 2020**
(30) **Foreign Application Priority Data**
Jul. 30, 2020 (CN) 202030425405.6
(51) **LOC (13) Cl.** **23-08**
(52) **U.S. Cl.**
USPC **D6/542**
(58) **Field of Classification Search**
USPC D9/682, 687, 552, 733; D23/270, 360,
D23/364-366, 213, 223, 226, 355;
D6/512, 553, 567, 542, 545
CPC A61L 2/00; A61L 2/10; A61L 2/22; A61L
9/02
See application file for complete search history.

(56) **References Cited**
U.S. PATENT DOCUMENTS

D415,413 S * 10/1999 Cummings D9/552
D440,866 S * 4/2001 Dailey D9/687
D475,876 S * 6/2003 Chen D6/545
D628,495 S * 12/2010 Sheikh D9/733
D726,444 S * 4/2015 Giovannoni D6/545
D809,819 S * 2/2018 Johnson D6/542
D811,120 S * 2/2018 Johnson D6/542

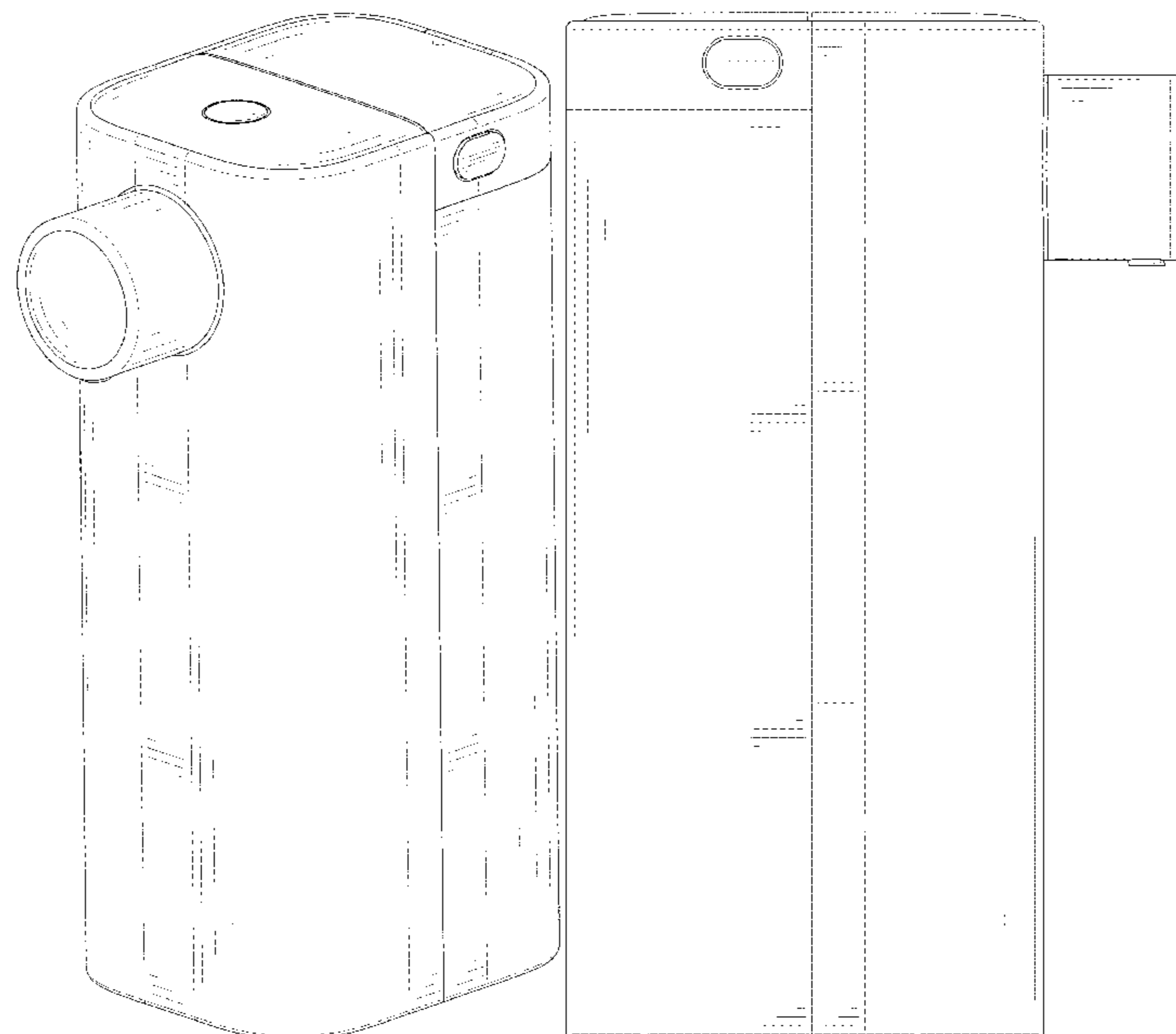

(56)

References Cited

OTHER PUBLICATIONS

Beyond Creation Premium Automatic Foaming Soap Dispenser. Date first available: Oct. 23, 2020. Site visited: Jul. 18, 2022. Available online: https://www.amazon.com/BEYOND-CREATION-Automatic-Dispenser-Touchless/dp/B08LQTZHBF/ref=asc_df_B08LQTZHBF/ (Year: 2020).*

Automatic Soap Dispenser. Date first available: Sep. 23, 2021. Date visited: Jul. 18, 2022. Available online: https://www.amazon.com/Automatic-Rechargeable-Wall-Mounted-Temperature-Adjustable/dp/B09GXQ3RMD/ref=sr_1_54 (Year: 2021).*

* cited by examiner

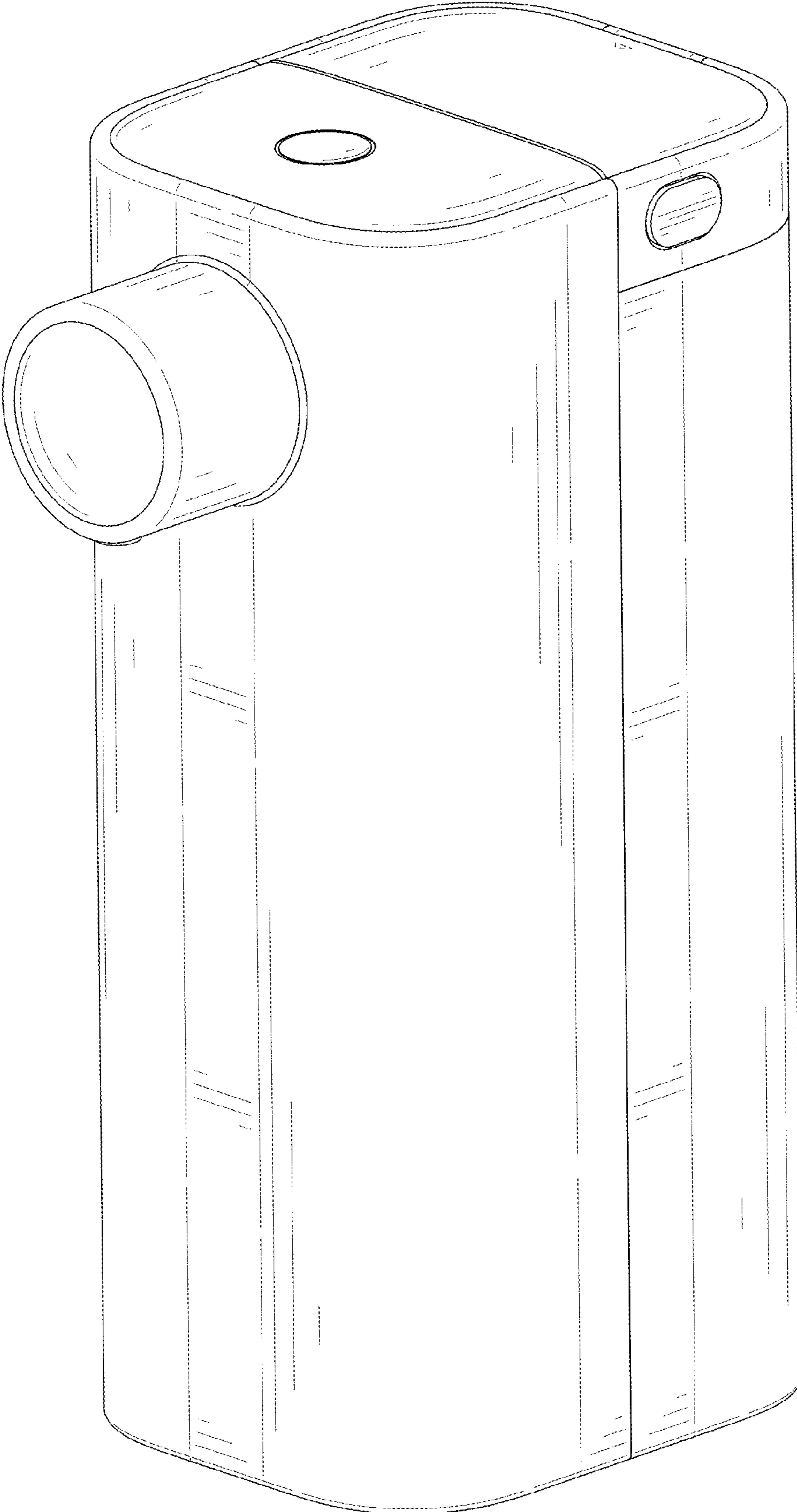

FIG. 1

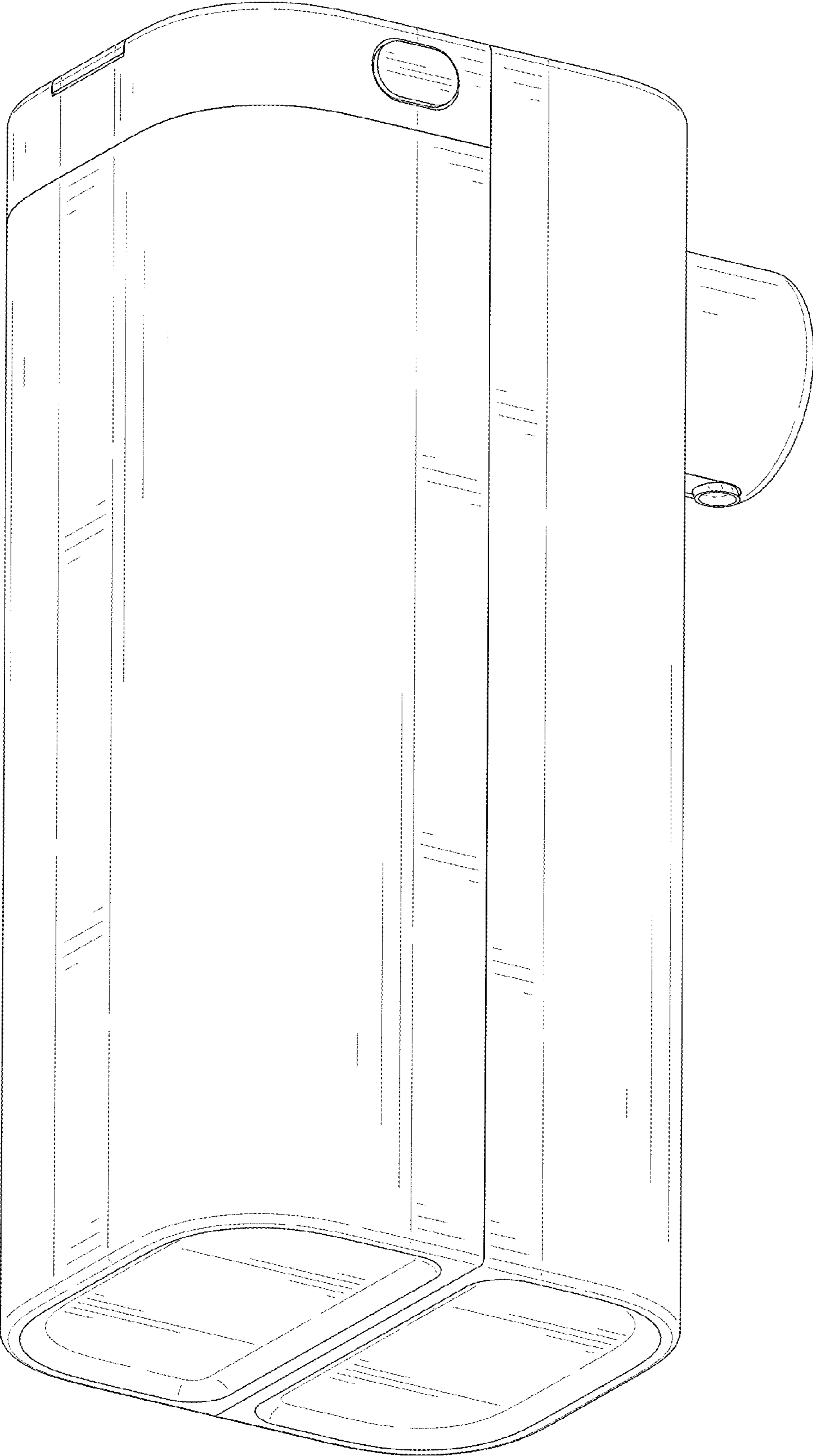

FIG. 2

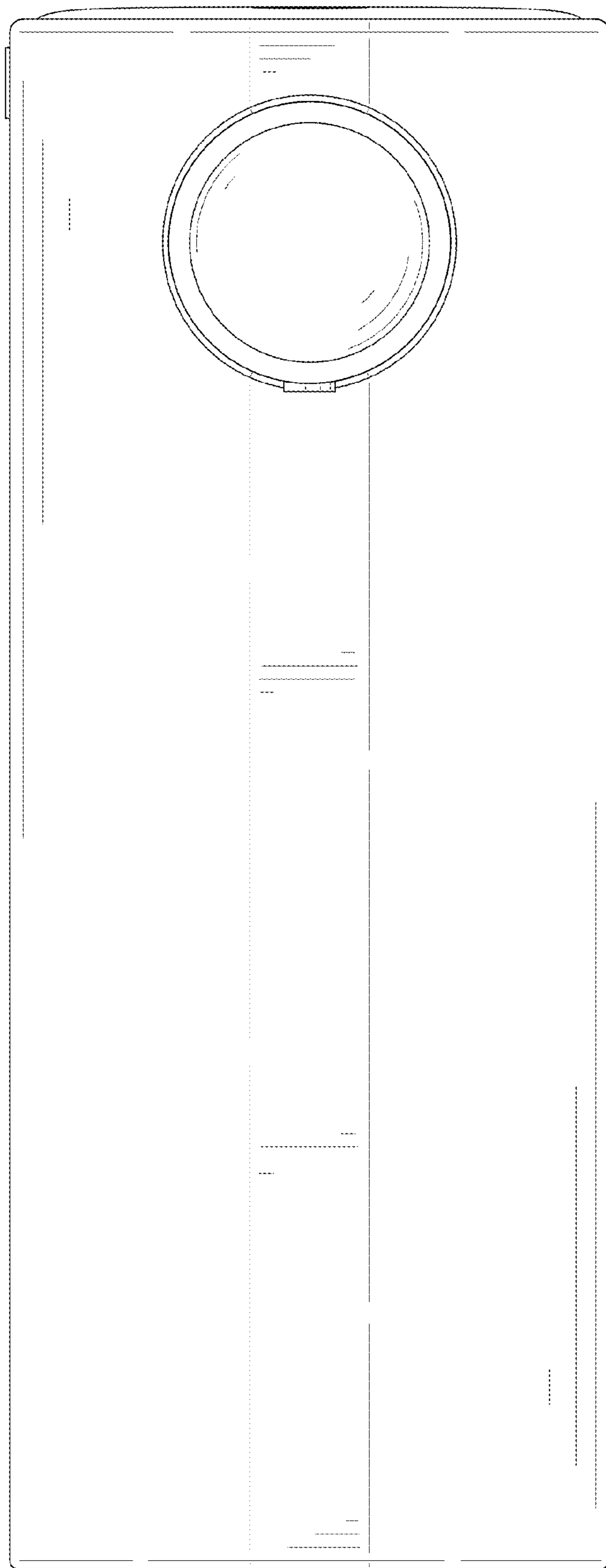

FIG. 3

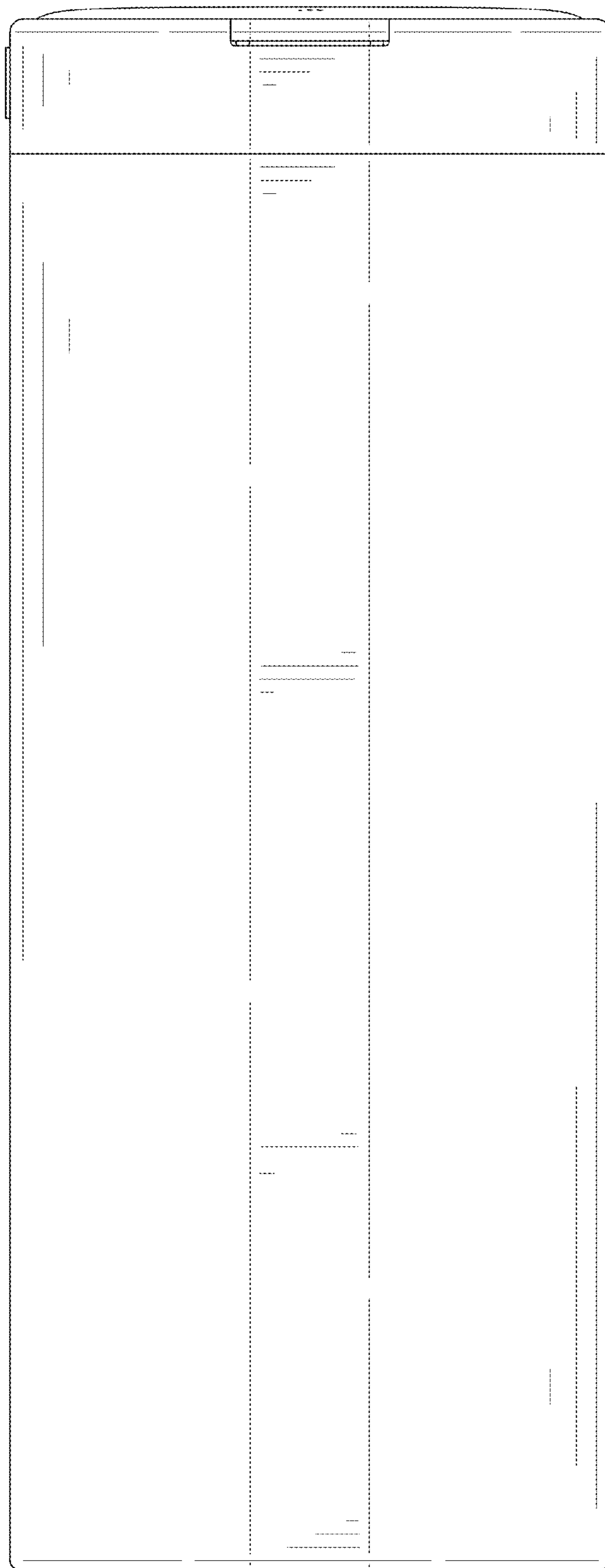

FIG. 4

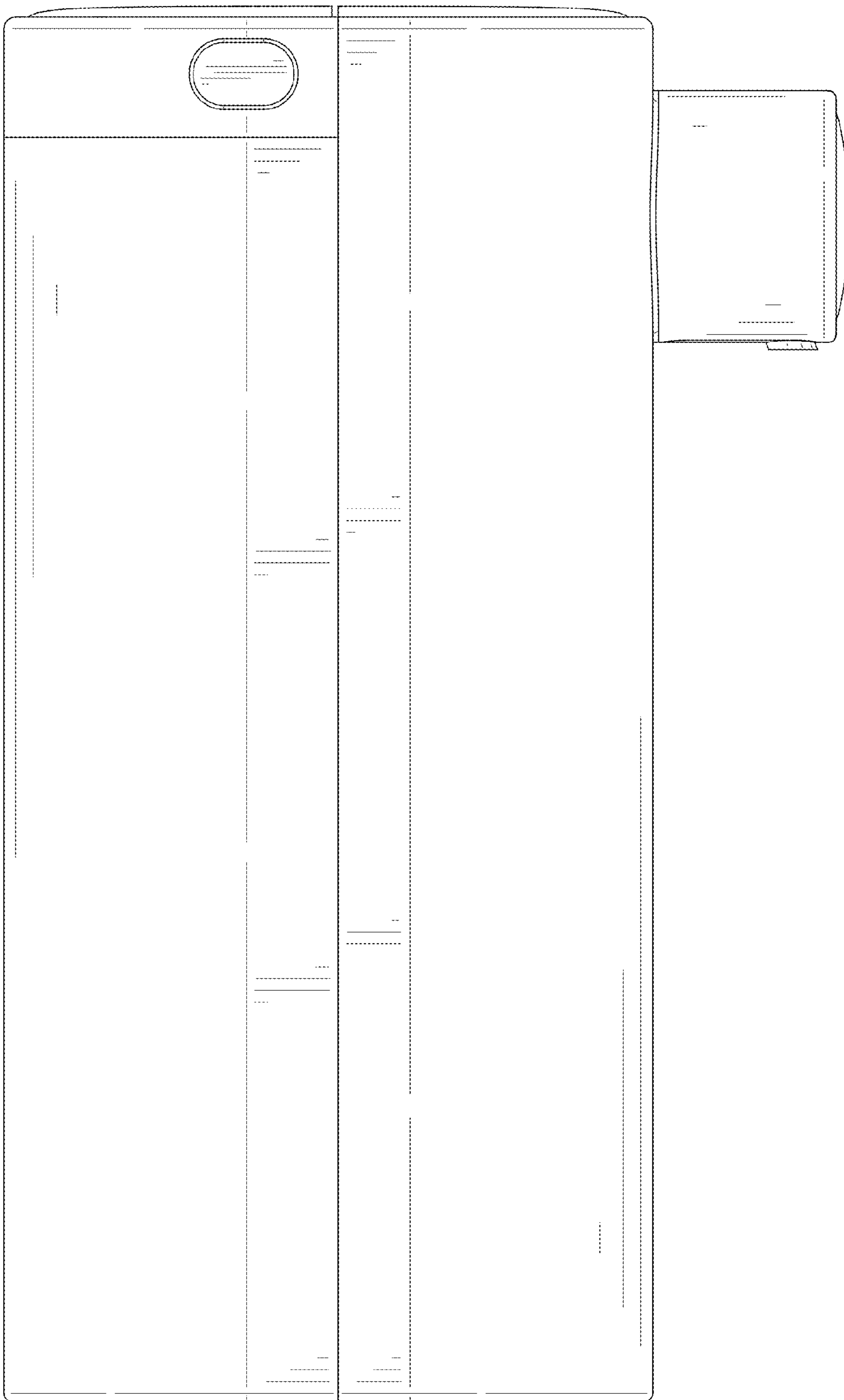

FIG. 5

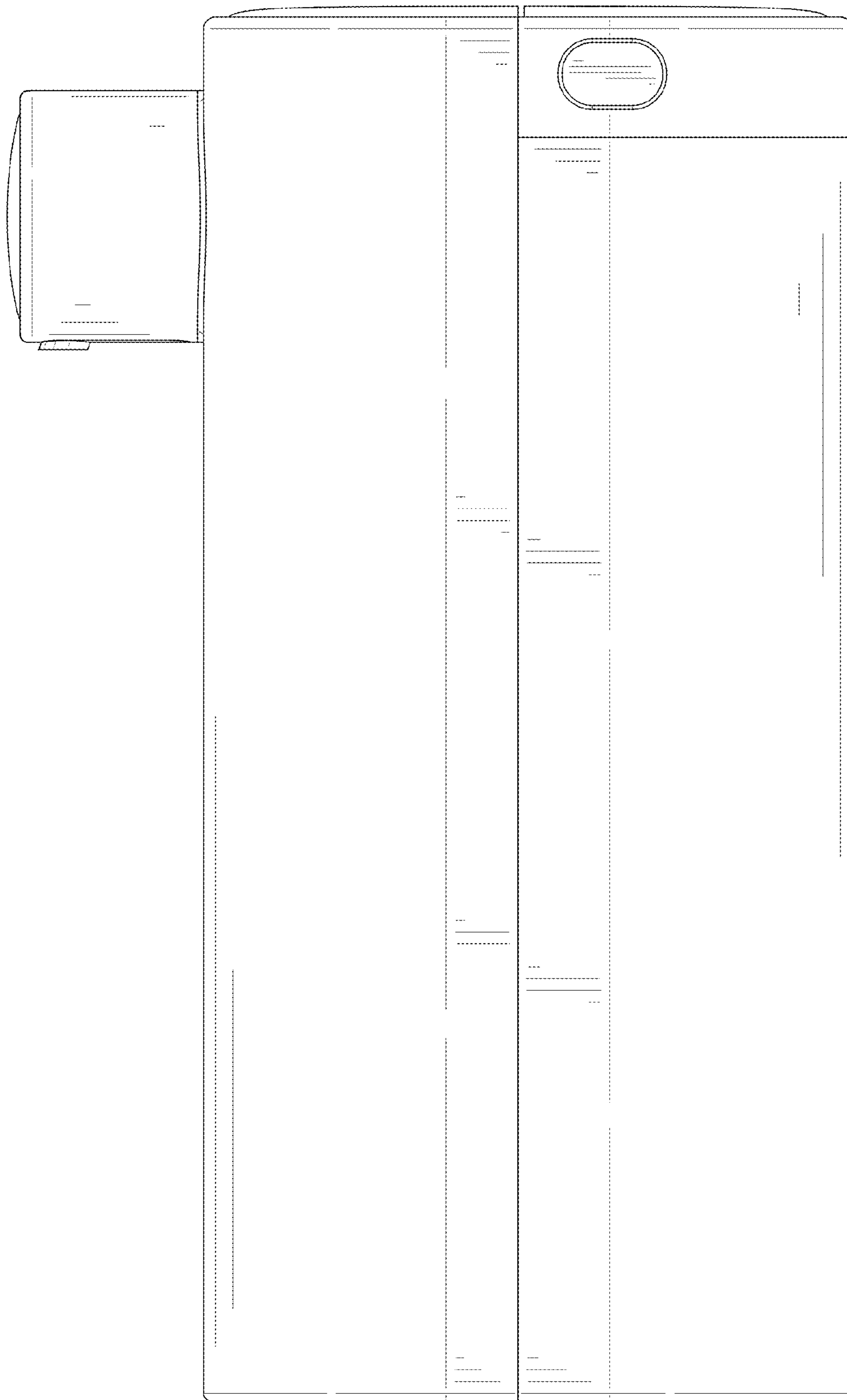

FIG. 6

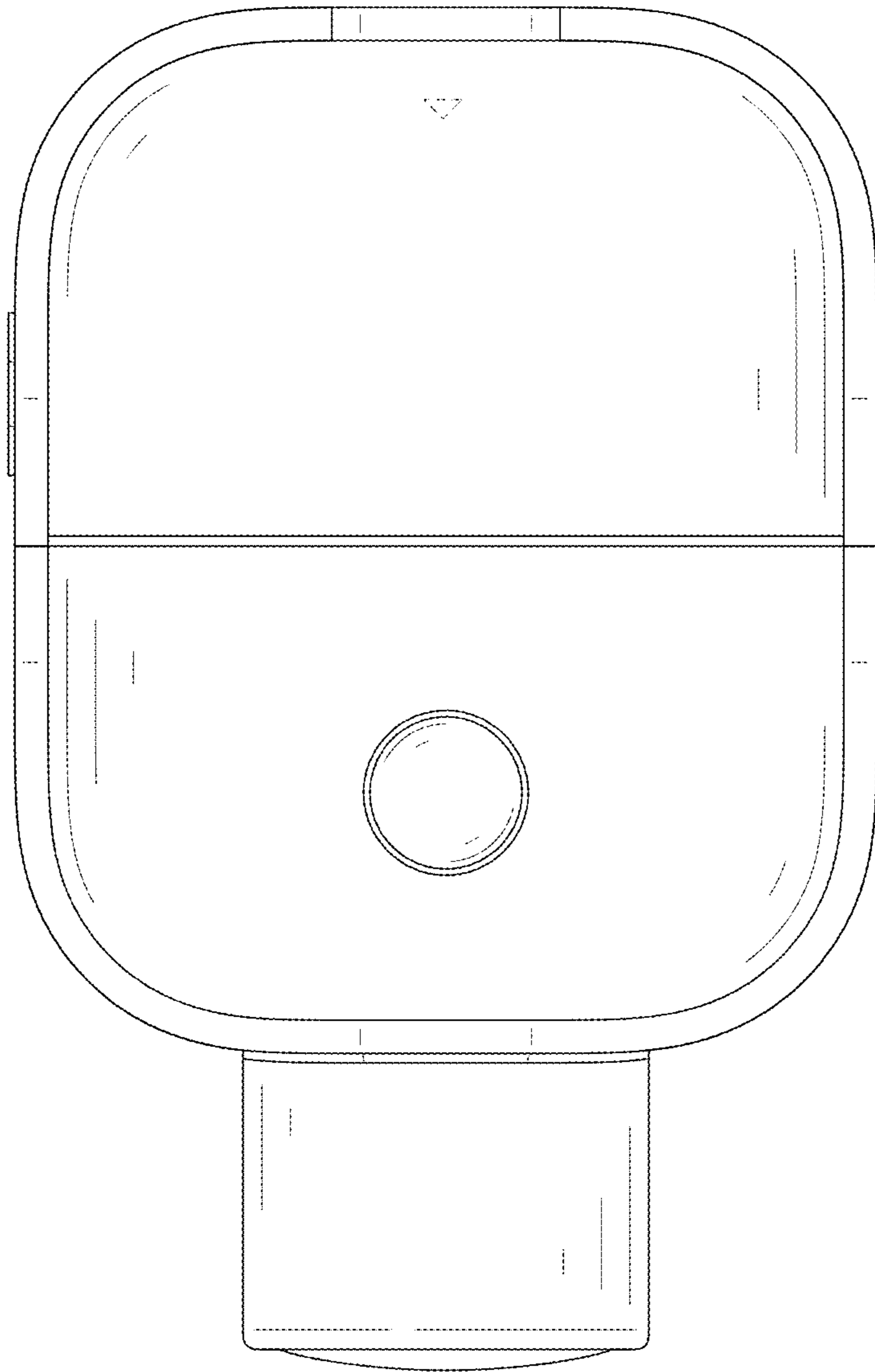

FIG. 7

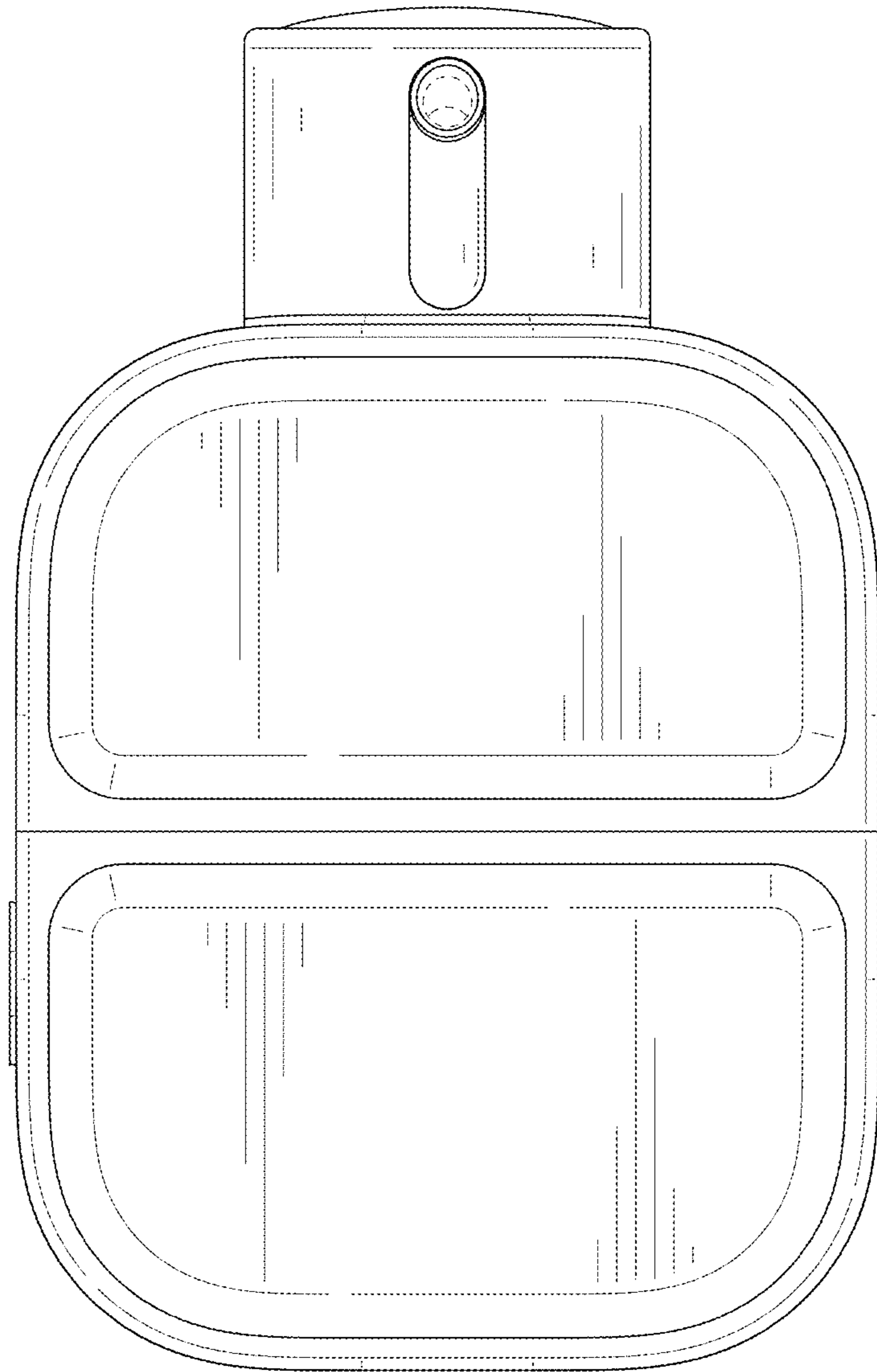

FIG. 8