



US00D973367S

(12) **United States Design Patent** (10) **Patent No.:** **US D973,367 S**
Jimenez et al. (45) **Date of Patent:** **** Dec. 27, 2022**

(54) **TOOTHBRUSH HANDLE**

Primary Examiner — Karen E Eldridge Powers

(71) Applicant: **Colgate-Palmolive Company**, New York, NY (US)

(57) **CLAIM**

The ornamental design for a toothbrush handle, as shown and described.

(72) Inventors: **Eduardo Jimenez**, Manalapan, NJ (US); **Bruce Cummings**, New York, NY (US); **Renee Marie Riethmiller**, Larchmont, NY (US)

DESCRIPTION

(73) Assignee: **Colgate-Palmolive Company**, New York, NY (US)

FIG. 1 is a front, top and left side perspective view of a toothbrush handle according to a first embodiment of the new design;

(**) Term: **15 Years**

FIG. 2 is a rear, bottom and right side perspective view thereof;

(21) Appl. No.: **29/758,463**

FIG. 3 is a front elevation view thereof;

(22) Filed: **Nov. 16, 2020**

FIG. 4 is a rear elevation view thereof;

(51) **LOC (13) Cl.** **28-03**

FIG. 5 is a left side elevation view thereof;

(52) **U.S. Cl.**

FIG. 6 is a right side elevation view thereof;

USPC **D4/101**

FIG. 7 is a top plan view thereof;

(58) **Field of Classification Search**

USPC D4/100, 101, 104, 105, 106, 107, 108, D4/109, 110, 111, 112, 113, 158

FIG. 8 is a bottom plan view thereof;

(Continued)

FIG. 9 is a front, top and left side perspective view of a toothbrush handle according to a second embodiment of the new design;

(56) **References Cited**

U.S. PATENT DOCUMENTS

2,835,912 A * 5/1958 Pensky A46B 5/02 15/246

FIG. 10 is a rear, bottom and right side perspective view thereof;

4,606,484 A 8/1986 Winter et al. (Continued)

FIG. 11 is a front elevation view thereof;

FIG. 12 is a rear elevation view thereof;

FOREIGN PATENT DOCUMENTS

CN 201431102 3/2010
CN 305318882 8/2019

FIG. 13 is a left side elevation view thereof;

FIG. 14 is a right side elevation view thereof;

FIG. 15 is a top plan view thereof;

FIG. 16 is a bottom plan view thereof;

FIG. 17 is a front perspective view of a handle portion of an oral care implement according to a third embodiment of the new design;

FIG. 18 is a rear perspective view thereof;

FIG. 19 is a front view thereof;

FIG. 20 is a rear view thereof;

FIG. 21 is a left side view thereof;

FIG. 22 is a right side view thereof;

FIG. 23 is a top view thereof; and,

FIG. 24 is a bottom view thereof.

The broken lines illustrate portions of the toothbrush handle that form no part of the claimed design.

OTHER PUBLICATIONS

Taiwanese Search Report issues in Taiwan Appln. No. 110302512 dated Dec. 2, 2021.

(Continued)

1 Claim, 12 Drawing Sheets

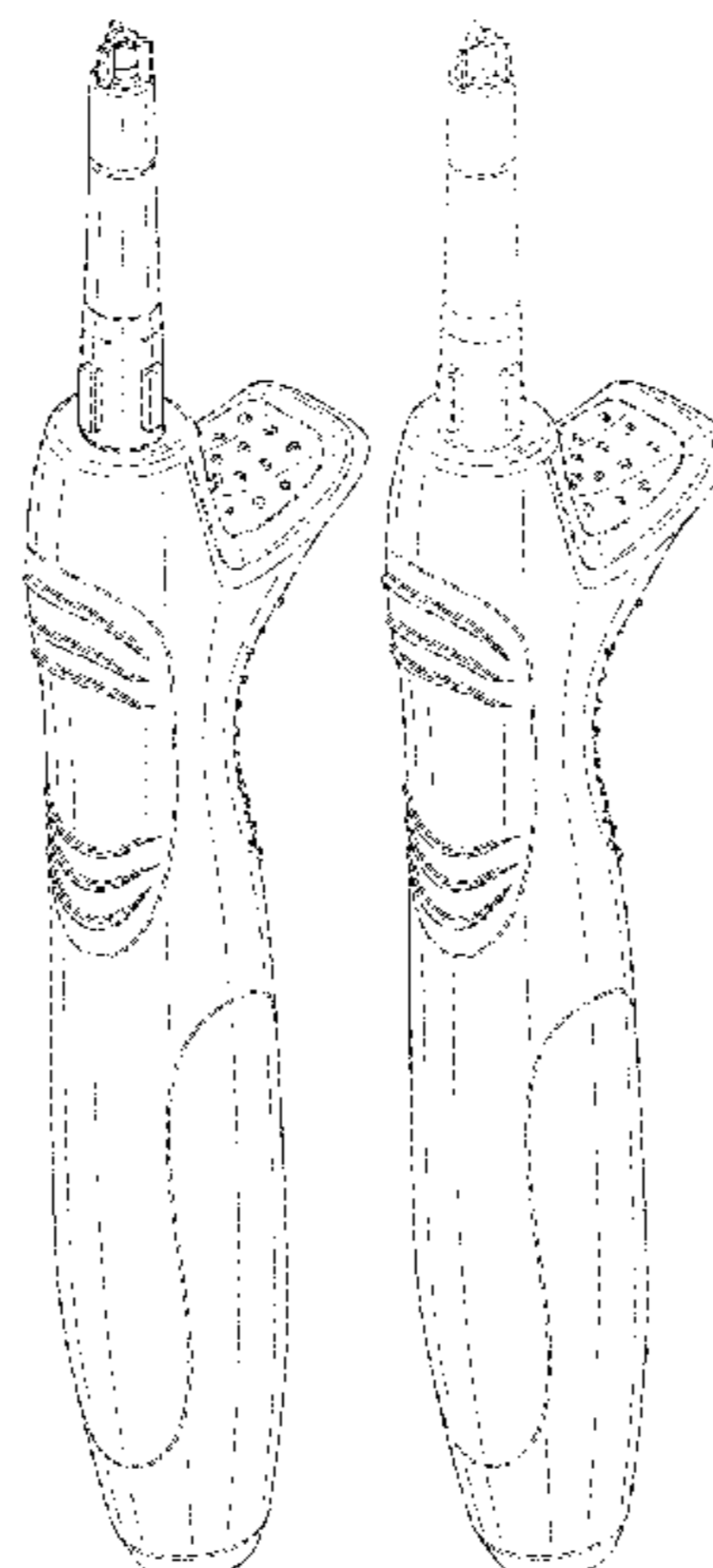

(58) **Field of Classification Search**
 CPC . A46B 5/0095; A46B 9/04; A46B 2200/1066;
 A46B 5/02
 See application file for complete search history.

(56) **References Cited**

U.S. PATENT DOCUMENTS

4,922,575	A	5/1990	Riemann	
5,774,921	A	7/1998	Harrison et al.	
5,791,705	A	8/1998	Romero et al.	
7,089,621	B2 *	8/2006	Hohlbein	A46B 9/06 601/142
D527,527	S	9/2006	Ramelli	
D577,198	S *	9/2008	Jimenez	D4/101
7,975,343	B2 *	7/2011	Hohlbein	A46B 15/0032 15/167.1
8,539,630	B2 *	9/2013	Gatzemeyer	A61C 17/0205 433/80
8,769,832	B1	7/2014	Joyner	
9,044,853	B2	6/2015	Phui	
D775,470	S *	1/2017	Xi	D4/138
D799,218	S *	10/2017	Okai	D4/104
D799,835	S *	10/2017	Okai	D4/101
D807,693	S	1/2018	Obmaces	
D823,000	S *	7/2018	Wainless	D4/104
D828,035	S *	9/2018	Wainless	D4/104
10,258,551	B2	4/2019	Rege et al.	
D851,938	S *	6/2019	Bloch	D4/101
10,449,022	B2 *	10/2019	Okai	A46B 9/06
10,449,663	B2	10/2019	Martin	
D866,193	S *	11/2019	Wainless	D4/138
D866,194	S *	11/2019	Wainless	D4/138

D867,762	S *	11/2019	Bloch	D4/101
10,603,147	B2 *	3/2020	Bloch	A46B 7/04
10,631,964	B2 *	4/2020	Bloch	A61C 17/3481
10,639,133	B2 *	5/2020	Bloch	A61C 17/222
D887,148	S *	6/2020	Okai	D4/104
10,709,533	B2 *	7/2020	Bloch	A61C 17/225
D895,973	S *	9/2020	Ji	D4/101
2008/0131842	A1	6/2008	Edwards	
2009/0144921	A1	6/2009	Newsome	
2015/0305483	A1	10/2015	Miller et al.	

FOREIGN PATENT DOCUMENTS

CN	305368567	9/2019
CN	305526416	12/2019
CN	305571153	1/2020
CN	305614134	2/2020
CN	305692562	4/2020
JP	H1014659	1/1998

OTHER PUBLICATIONS

Taiwanese Search Report issues in Taiwan Appln. No. 110302514 dated Dec. 2, 2021.
 Taiwanese Search Report issues in Taiwan Appln. No. 110302515 dated Dec. 3, 2021.
 Taiwanese Search Report issues in Taiwan Appln. No. 110302516 dated Dec. 4, 2021.
 International Search Report and the Written Opinion of the International Searching Authority issued in International Application PCT/US2021/057528 dated Jan. 28, 2022.

* cited by examiner

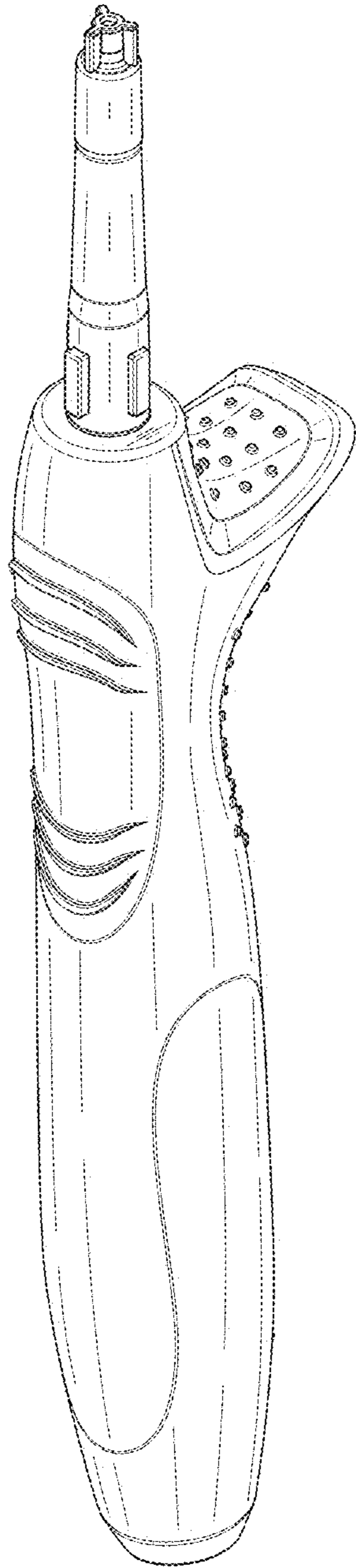

FIG. 1

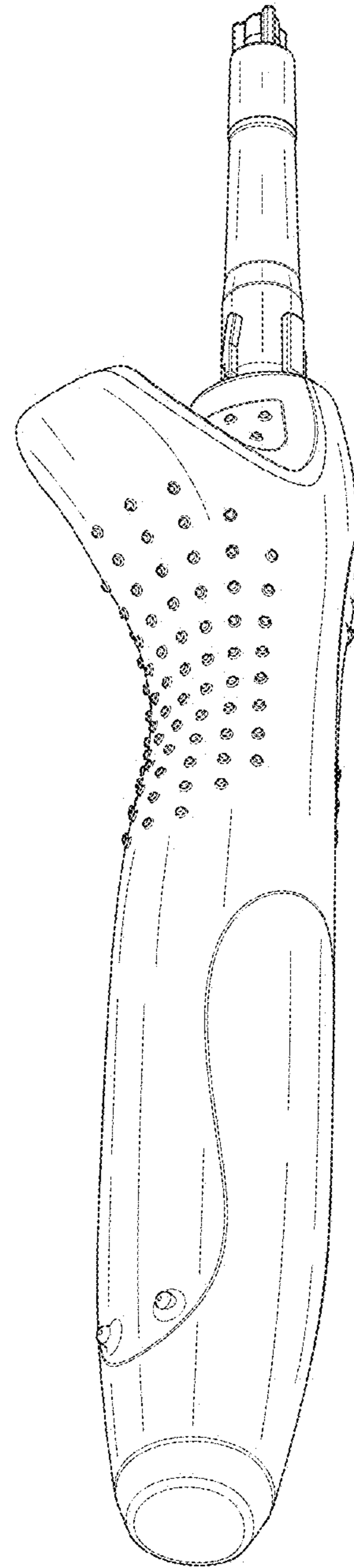

FIG. 2

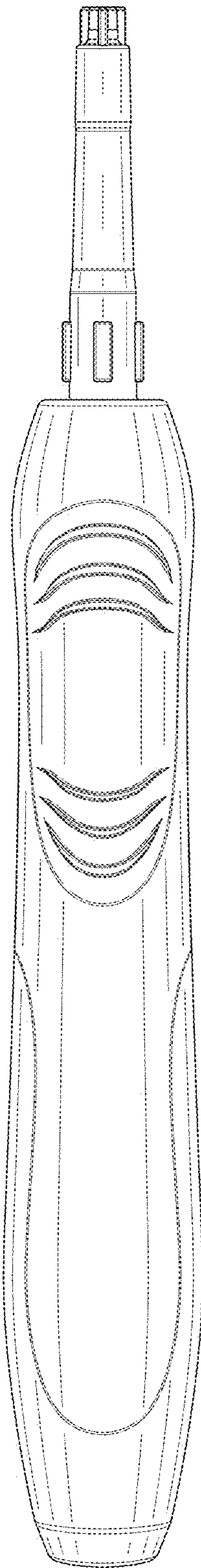

FIG. 3

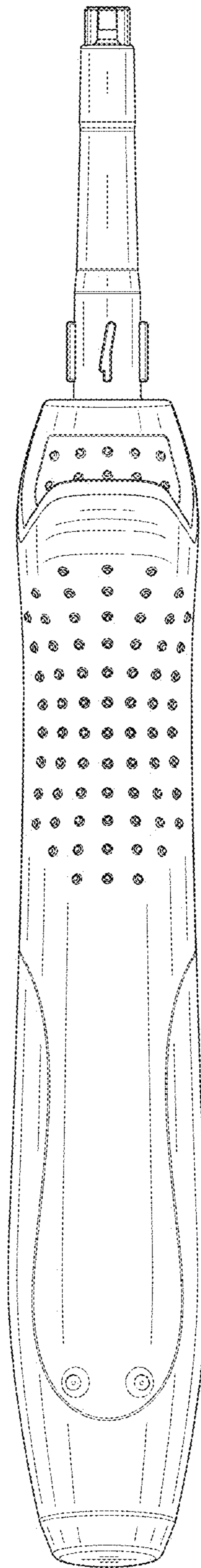

FIG. 4

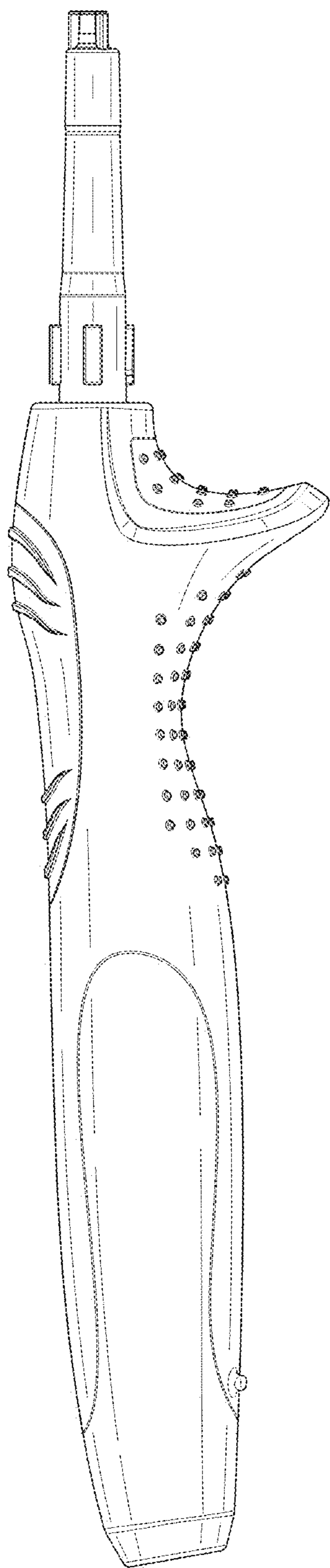

FIG. 5

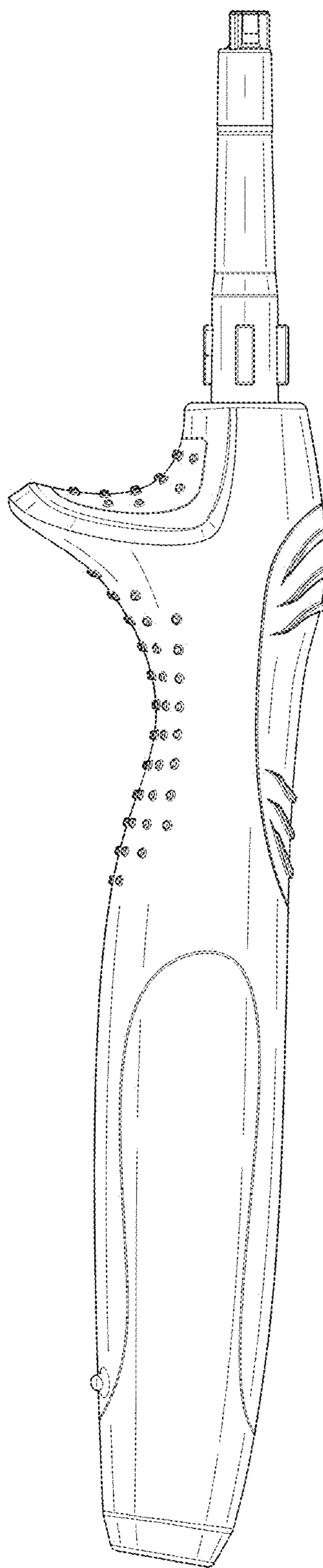

FIG. 6

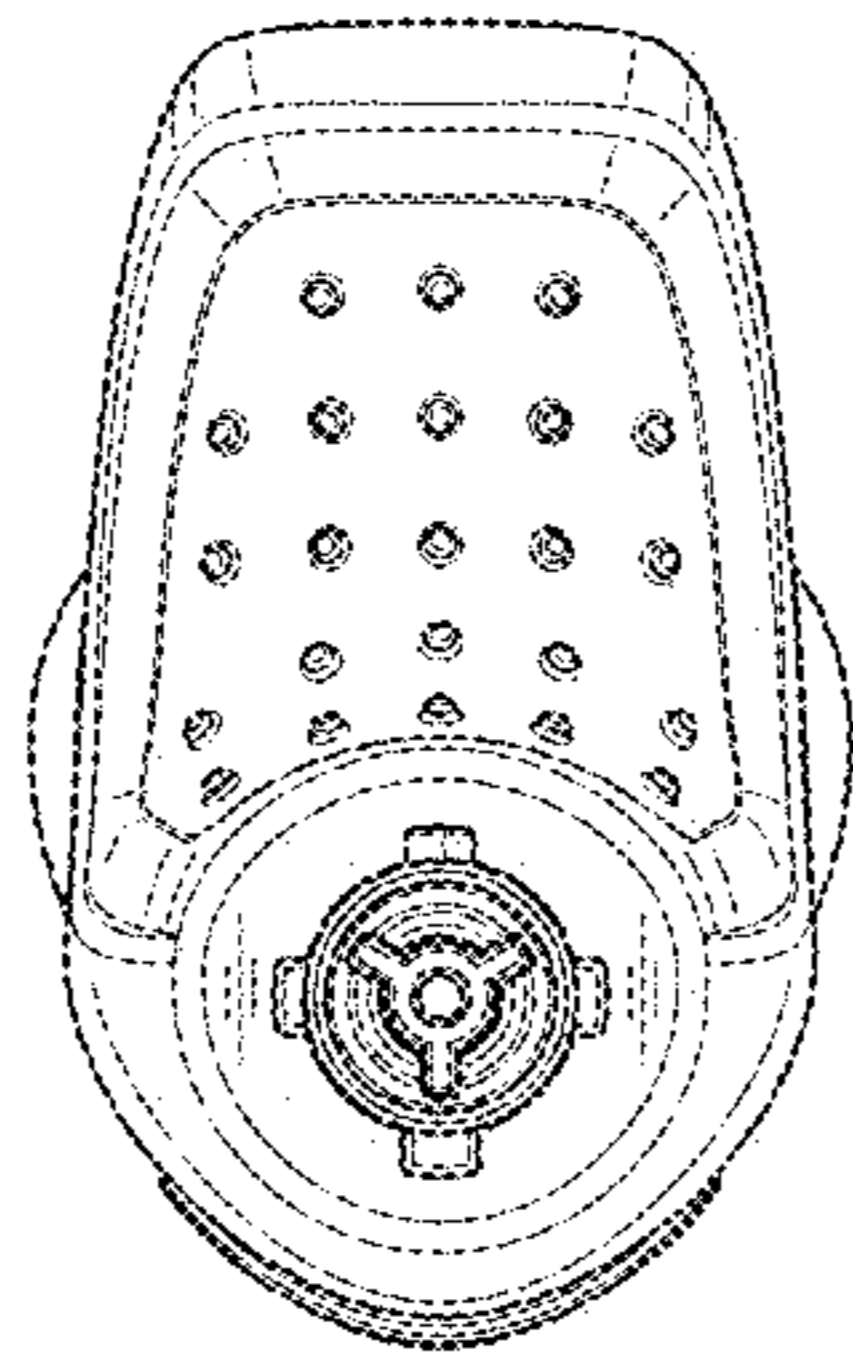

FIG. 7

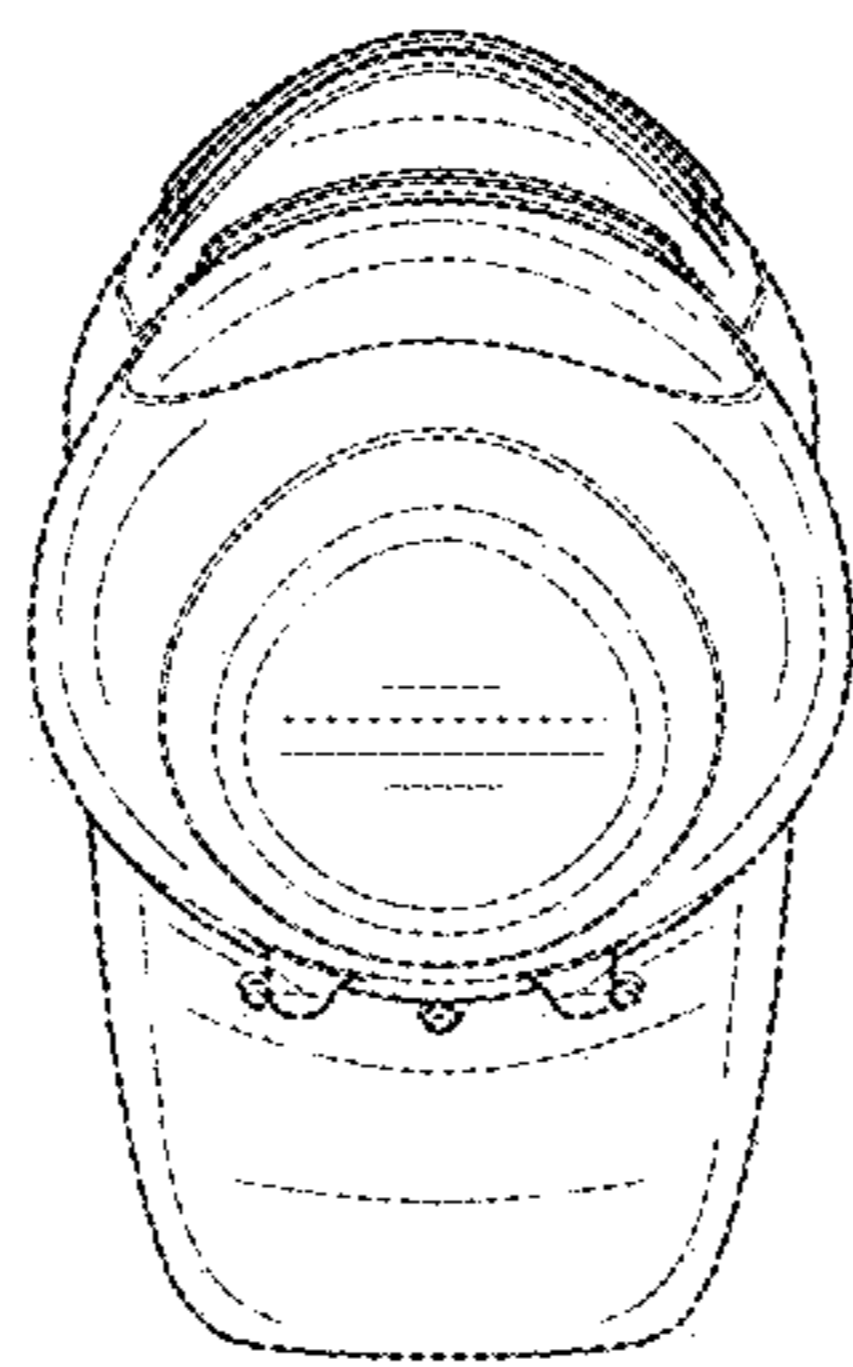

FIG. 8

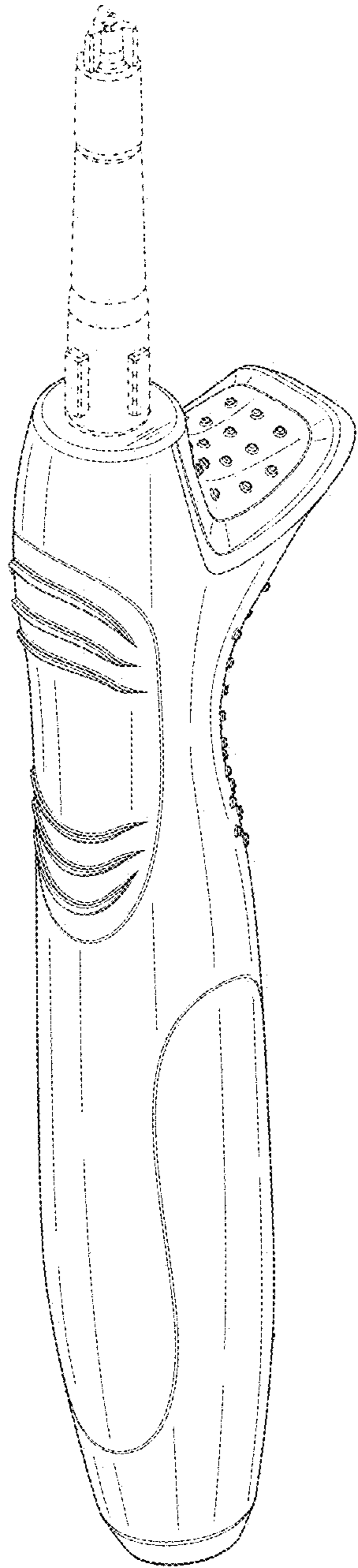

FIG. 9

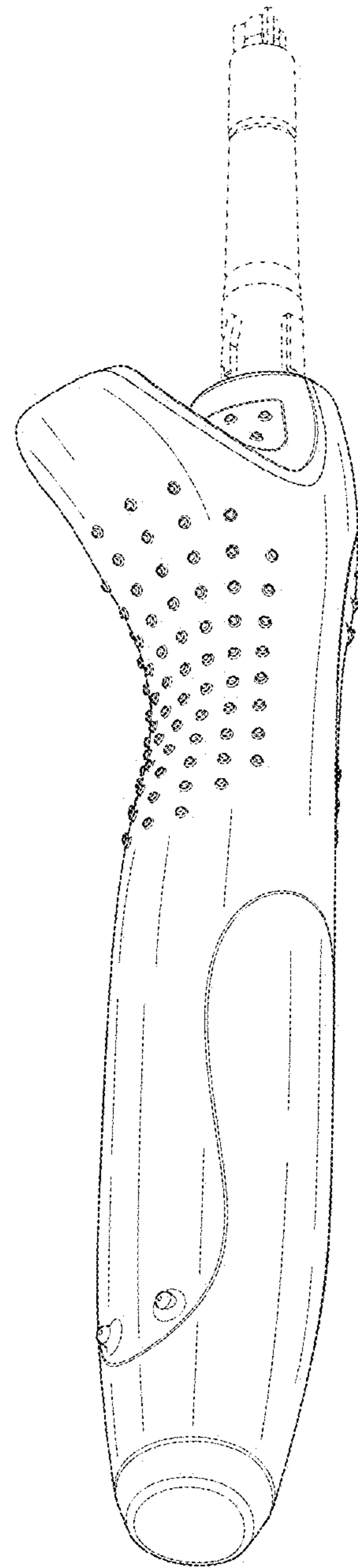

FIG. 10

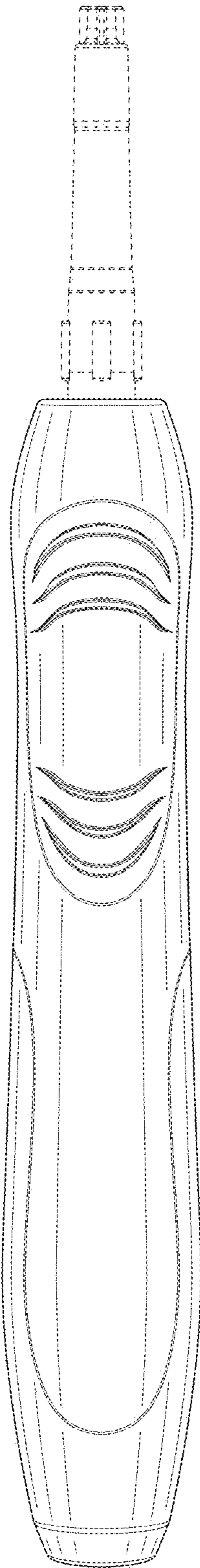

FIG. 11

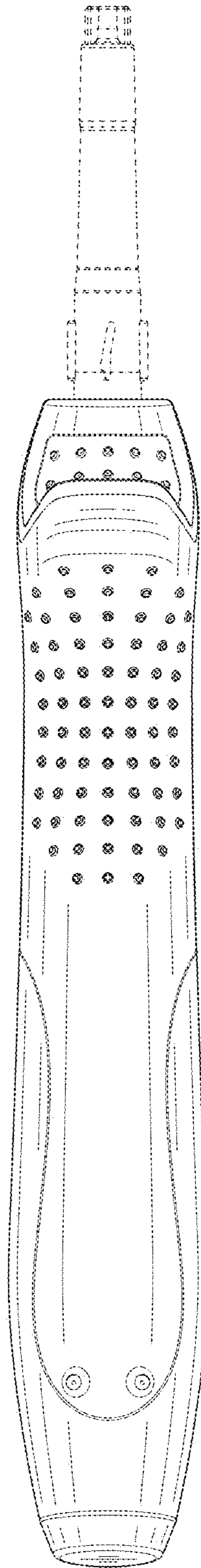

FIG. 12

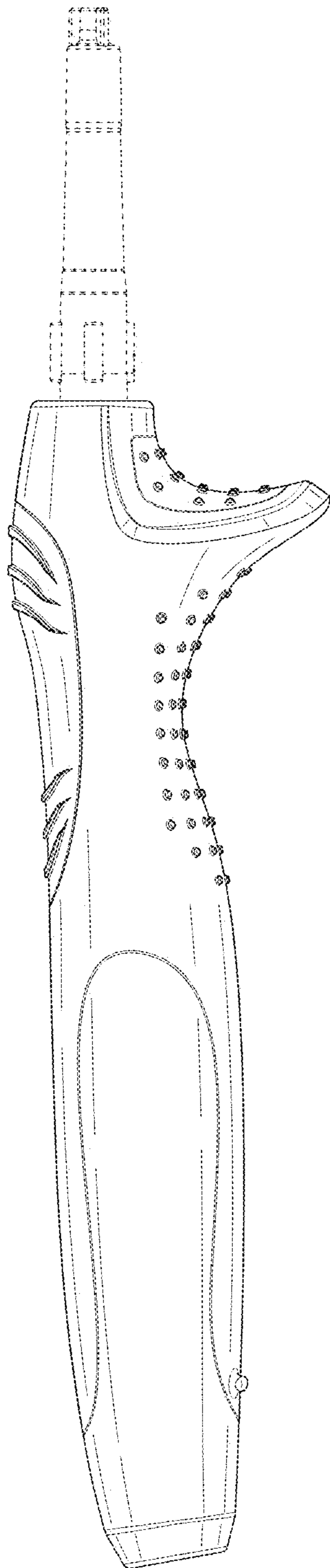

FIG. 13

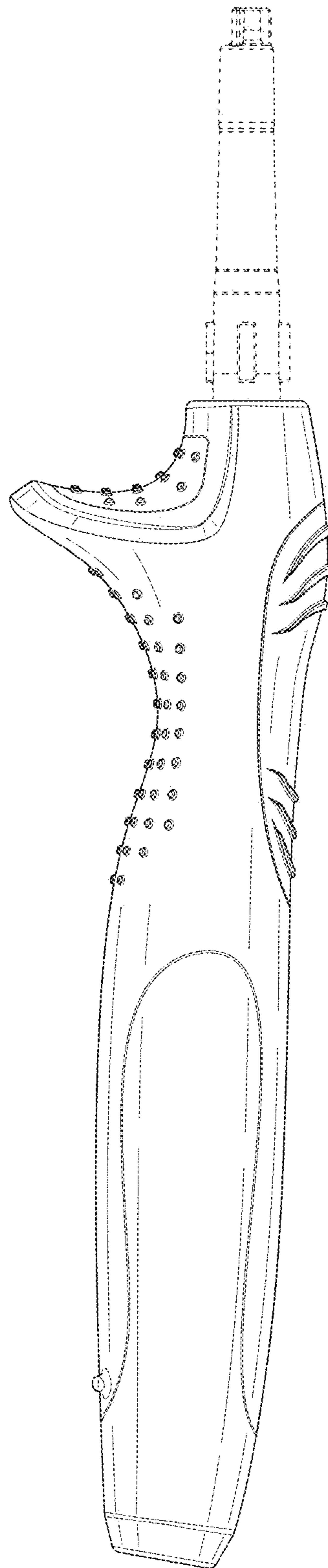

FIG. 14

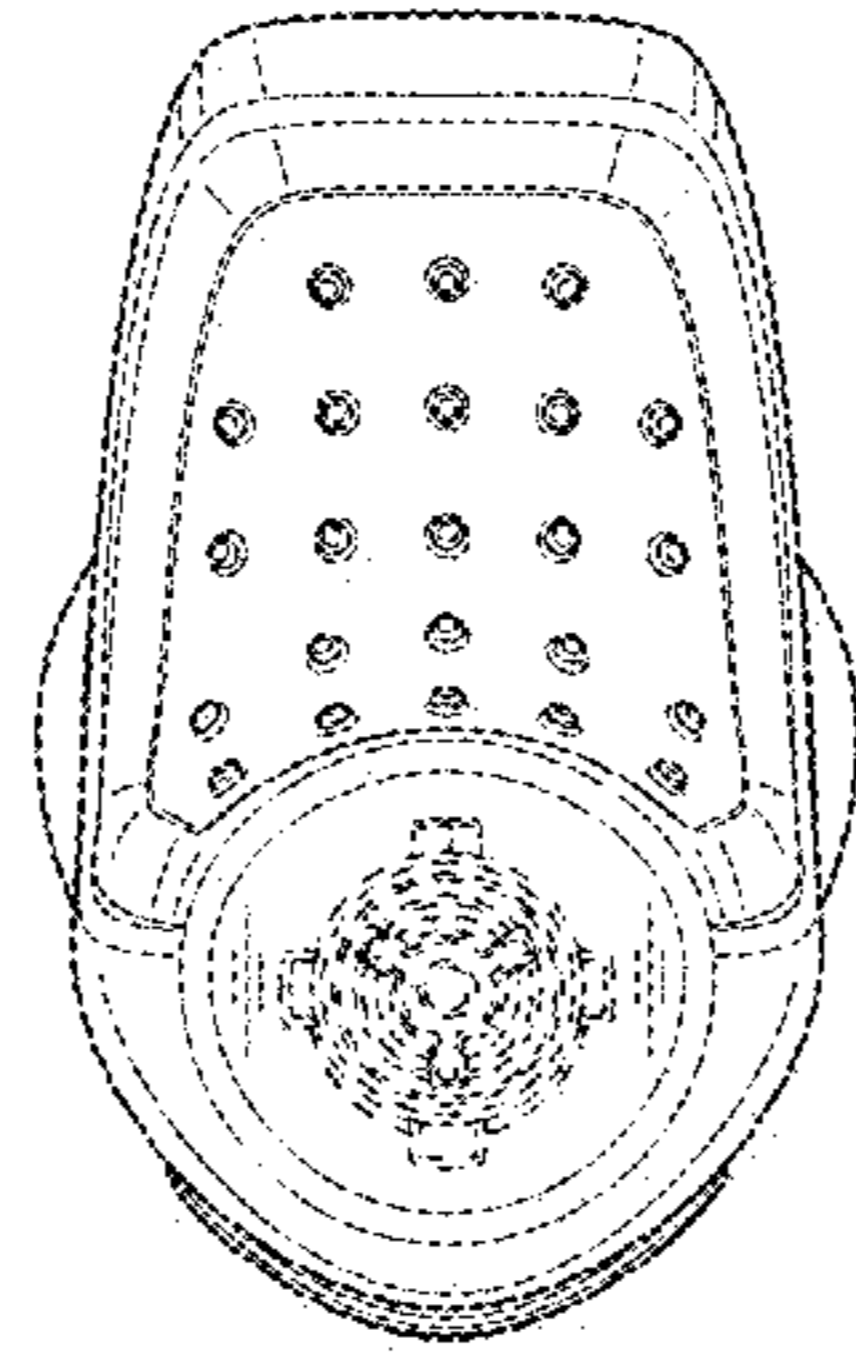

FIG. 15

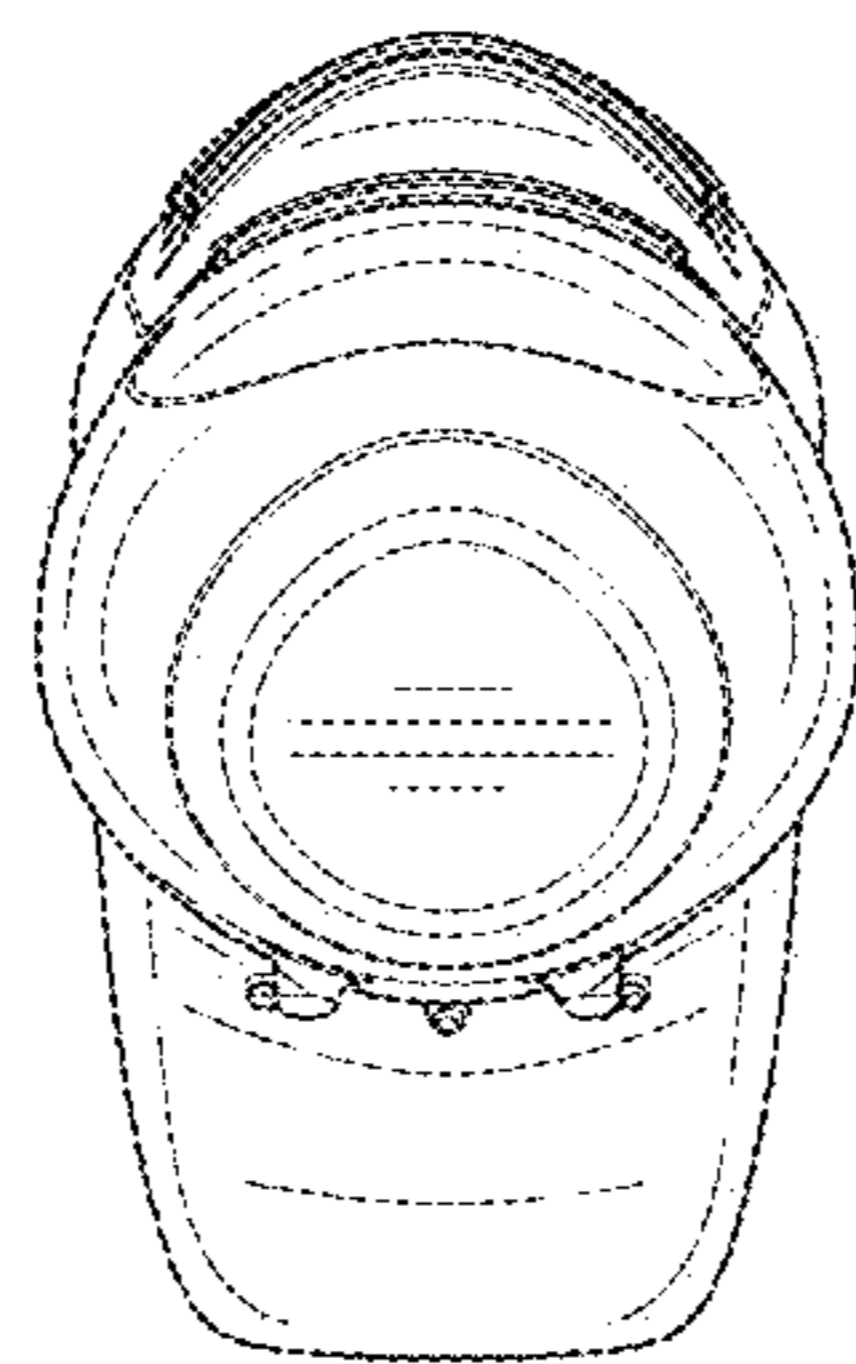

FIG. 16

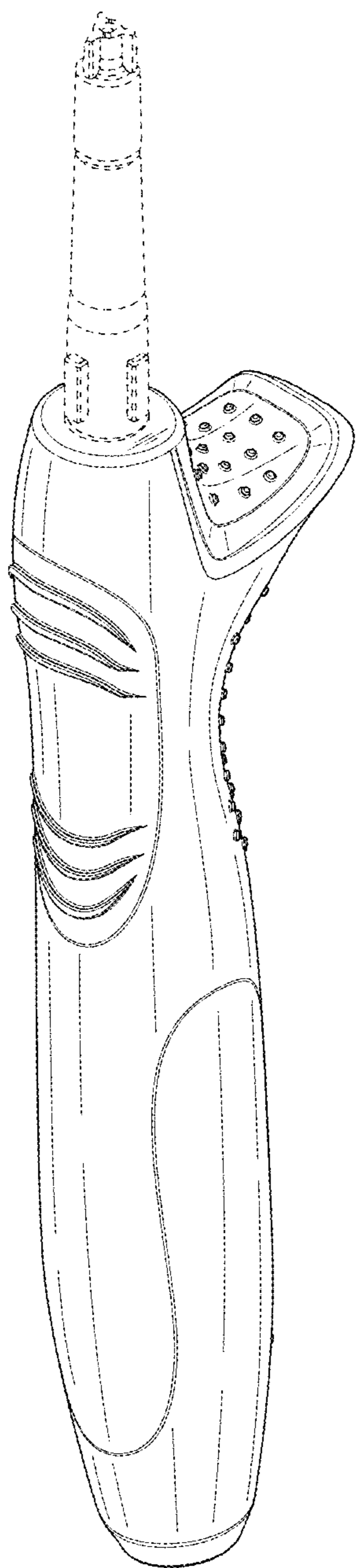

FIG. 17

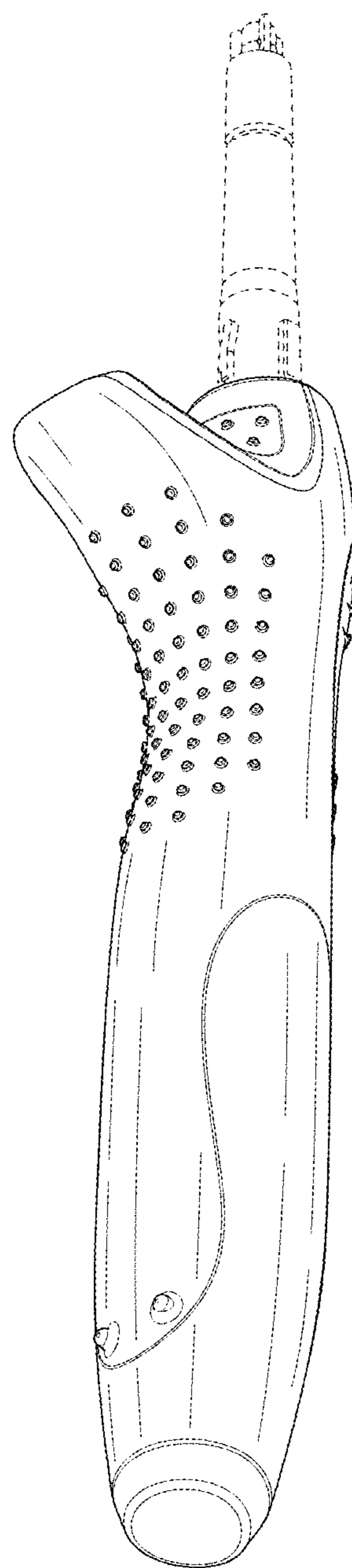

FIG. 18

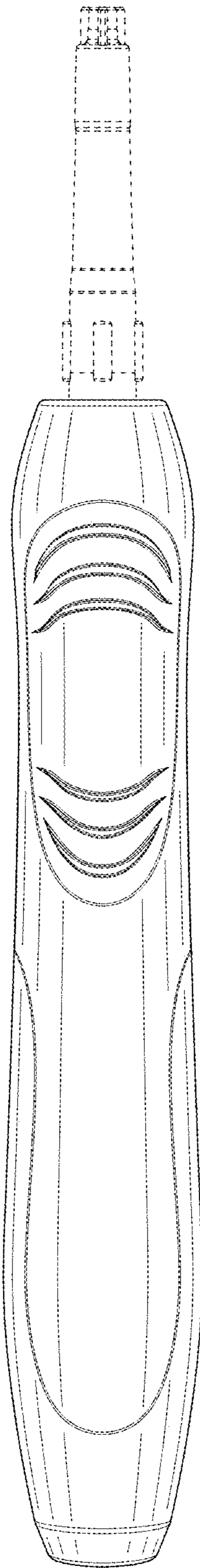

FIG. 19

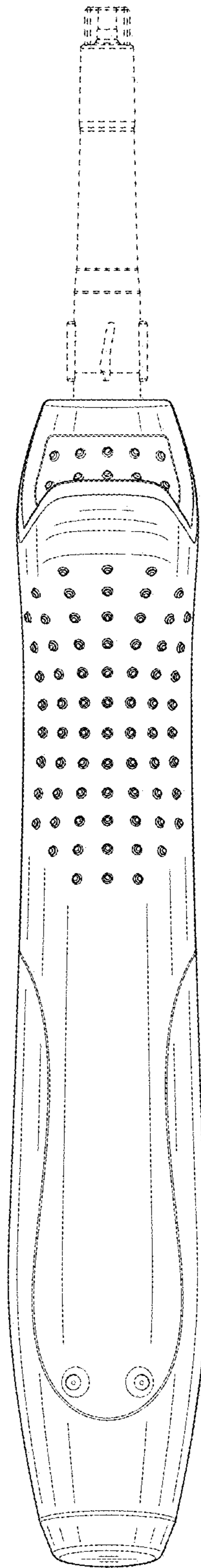

FIG. 20

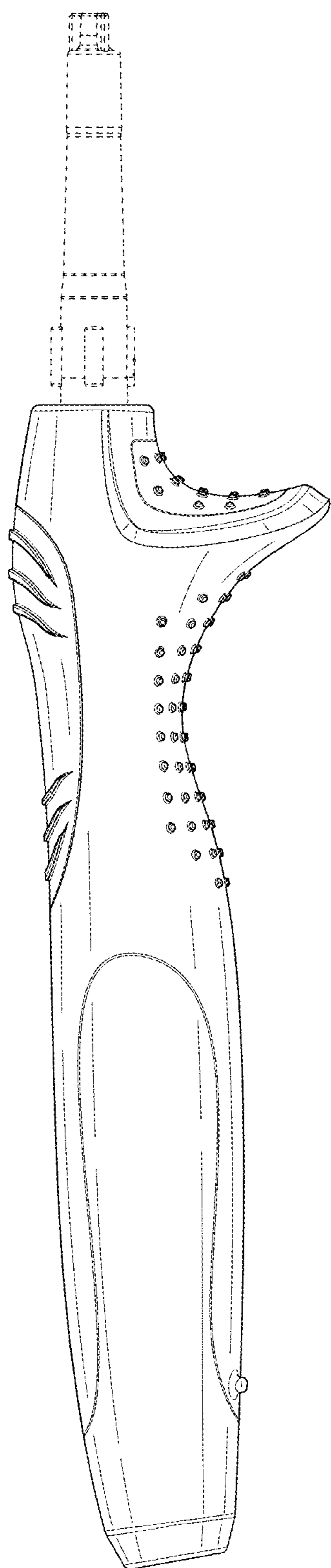

FIG. 21

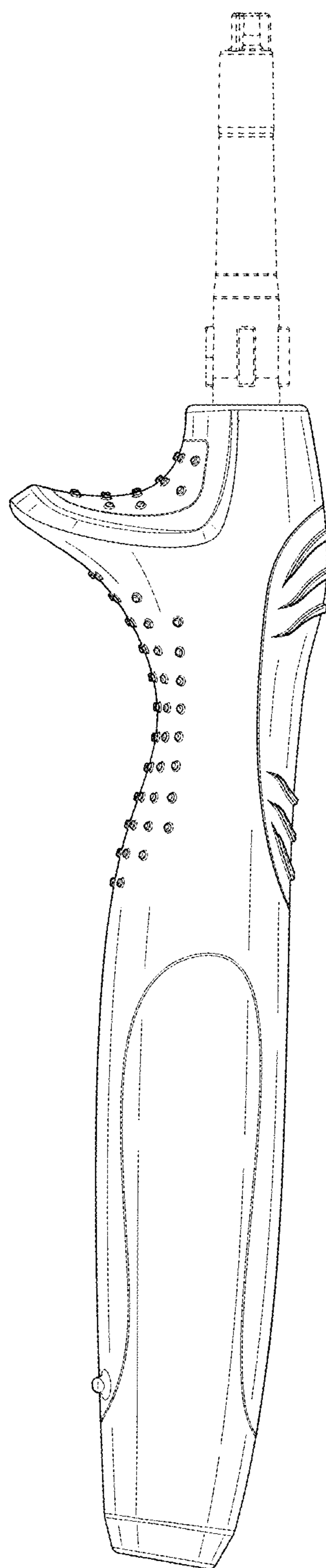

FIG. 22

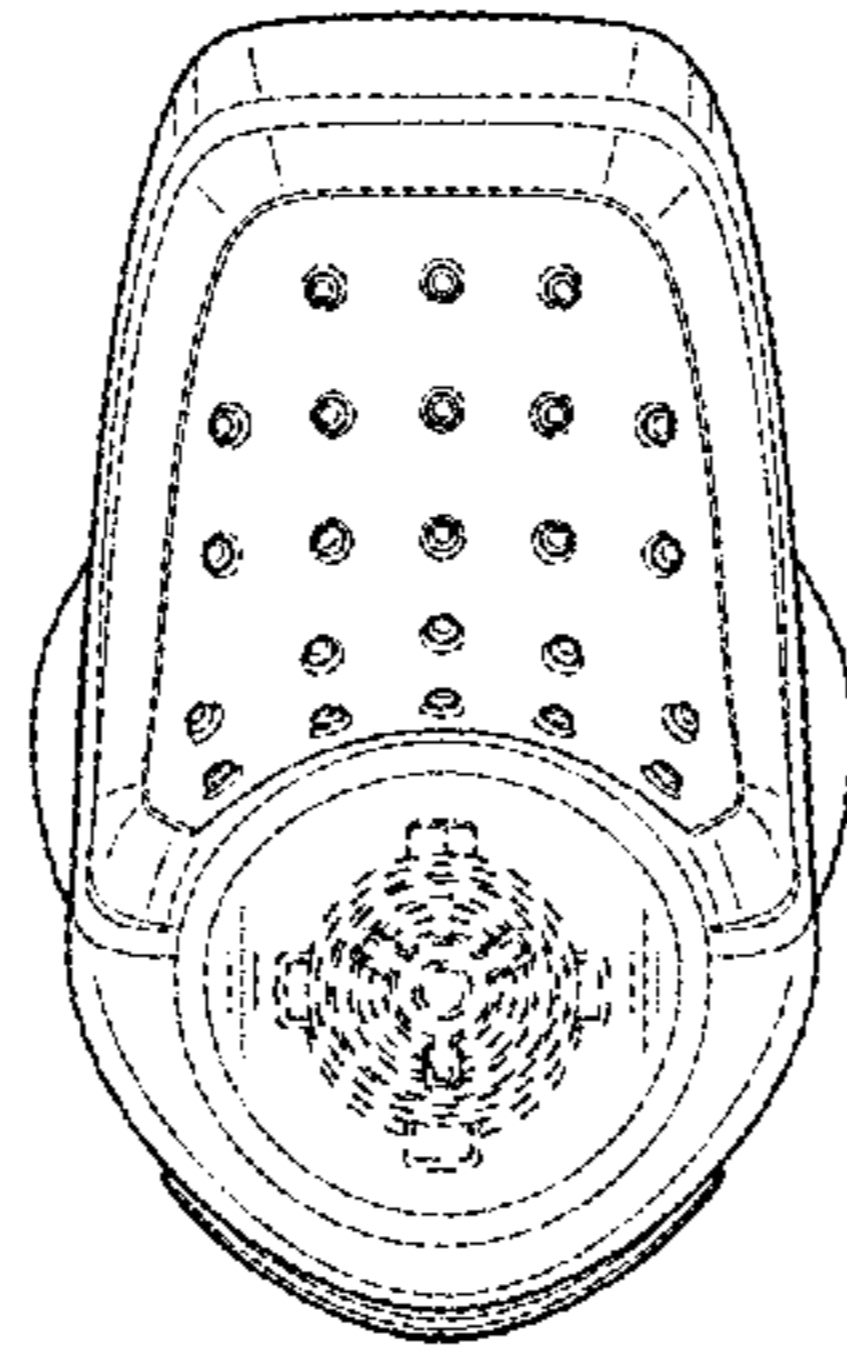

FIG. 23

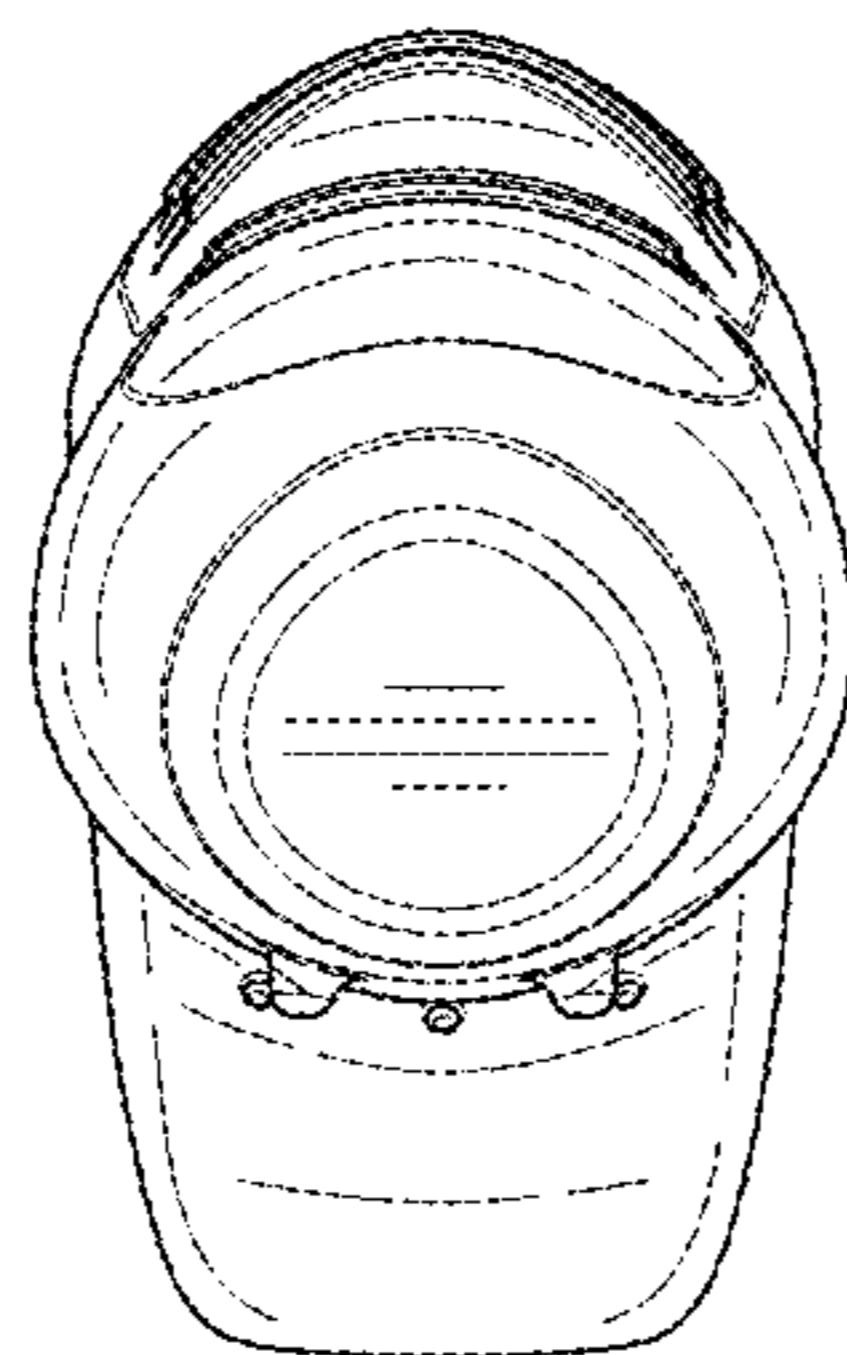

FIG. 24