



US00D973362S

(12) **United States Design Patent** (10) **Patent No.:** **US D973,362 S**  
**Su** (45) **Date of Patent:** **\*\* Dec. 27, 2022**

(54) **FOLDABLE BASKET**

D932,769 S \* 10/2021 Dittrich ..... D3/306  
D936,364 S \* 11/2021 Zheng ..... D3/307  
D948,217 S \* 4/2022 Budzak ..... D3/306

(71) Applicant: **Hsiao-Man Su**, Niaosung Dist. (TW)

\* cited by examiner

(72) Inventor: **Hsiao-Man Su**, Niaosung Dist. (TW)

*Primary Examiner* — Mary Shannon Malley  
*Assistant Examiner* — Christopher John Suarez La Rosa  
(74) *Attorney, Agent, or Firm* — Che-Yang Chen; Law Office of Michael Chen

(\*\*) Term: **15 Years**

(21) Appl. No.: **29/754,213**

(57) **CLAIM**

(22) Filed: **Oct. 8, 2020**

The ornamental design for a foldable basket, as shown and described.

(51) **LOC (13) Cl.** ..... **03-01**

(52) **U.S. Cl.**  
USPC ..... **D3/306**

**DESCRIPTION**

(58) **Field of Classification Search**  
USPC ..... D3/304–314; D6/566, 556, 558;  
D7/601, 667, 704  
CPC ..... B65D 7/20; B65D 25/32; B21F 27/128;  
B62B 3/14  
See application file for complete search history.

FIG. 1 is a perspective view of a foldable basket showing the new design;  
FIG. 2 is a front or rear view thereof;  
FIG. 3 is a left or right side elevational view thereof;  
FIG. 4 is top view thereof;  
FIG. 5 is a bottom view thereof;  
FIG. 6 is a perspective view thereof, showing the foldable basket in a partially disassembled configuration;  
FIG. 7 is an enlarged view of a corner of the foldable basket in FIG. 6; and,  
FIG. 8 is another perspective view thereof, showing the foldable basket in an unfolded configuration.  
The long dash-short dash broken lines in FIG. 6 & FIG. 7 represent the bounds of the enlargement taken from FIG. 6 and form no part of the claimed design.  
The remaining long dash-short dash broken line depicts a guide line and forms no part of the claimed design.

(56) **References Cited**

U.S. PATENT DOCUMENTS

2,721,671 A \* 10/1955 Averill ..... B65D 21/0211  
206/509  
D669,686 S \* 10/2012 Waggoner ..... D3/306  
D784,700 S \* 4/2017 Goodman ..... D3/306  
D793,087 S \* 8/2017 Goodman ..... D3/306  
D802,927 S \* 11/2017 Thoma ..... D3/307  
D814,189 S \* 4/2018 Nimgulkar ..... D3/306  
D819,333 S \* 6/2018 Goodman ..... D3/306  
D901,180 S \* 11/2020 Li ..... D3/305  
D931,607 S \* 9/2021 Dittrich ..... D3/306  
D931,608 S \* 9/2021 Dittrich ..... D3/306

**1 Claim, 8 Drawing Sheets**

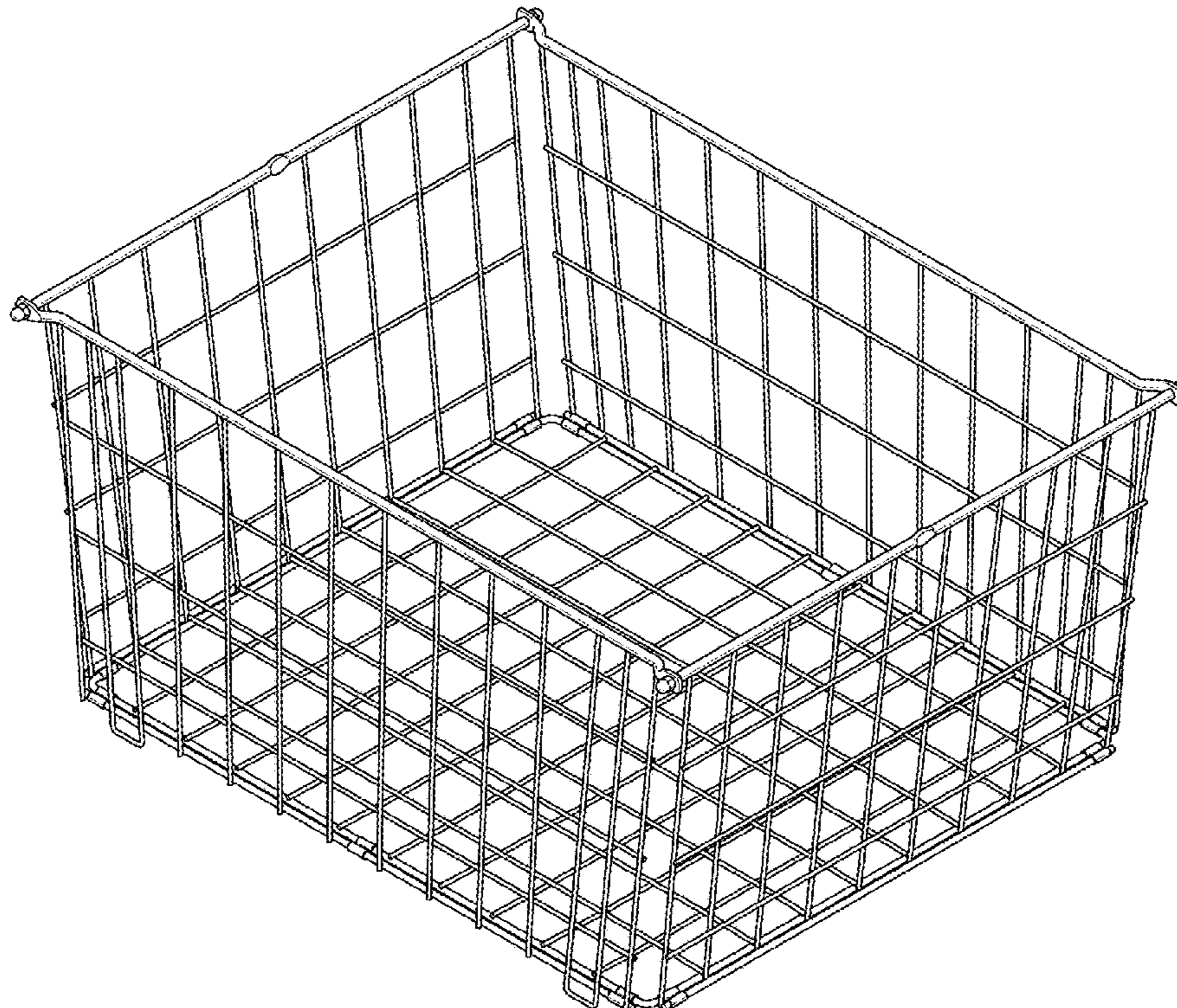

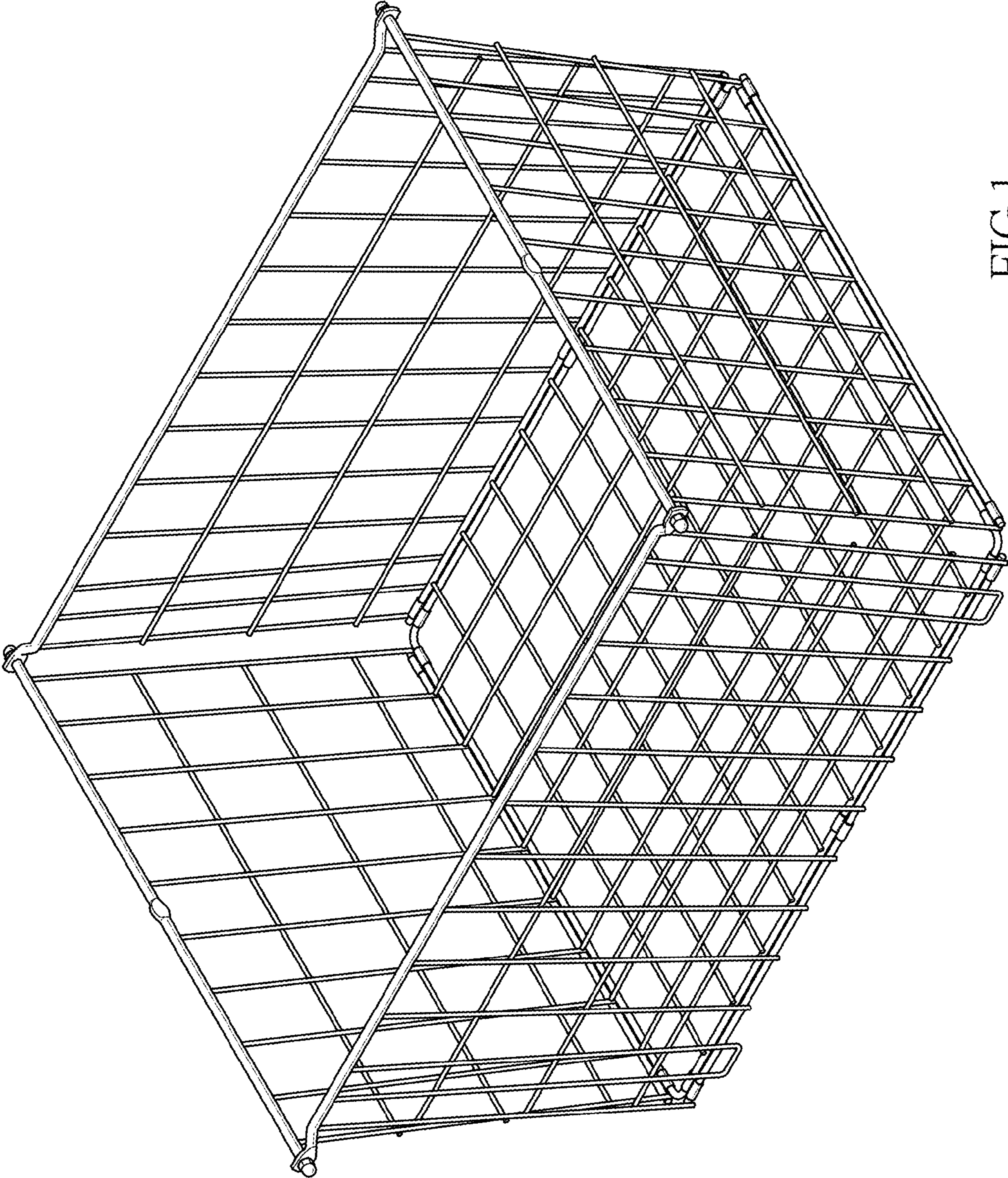

FIG. 1

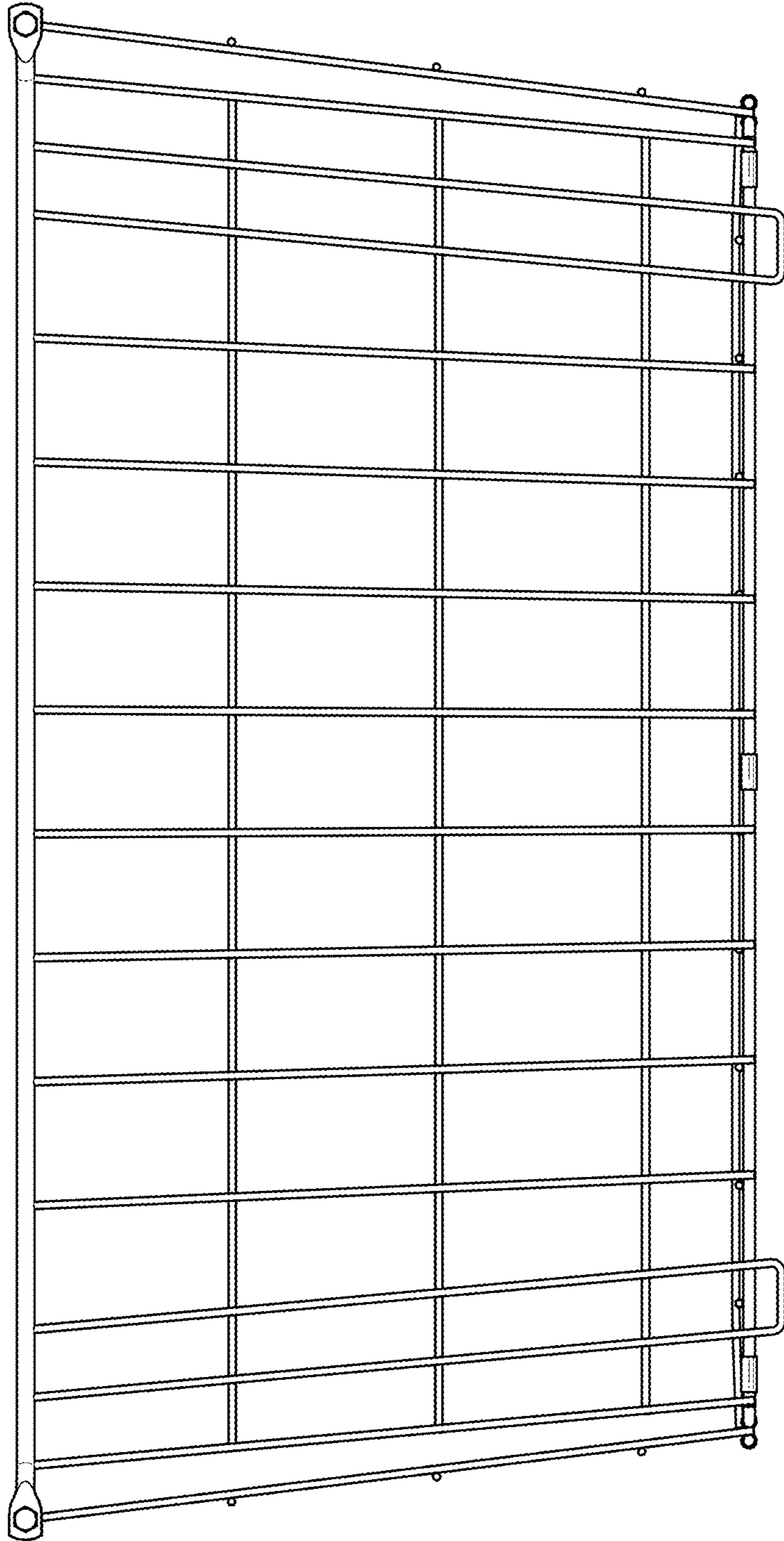

FIG.2

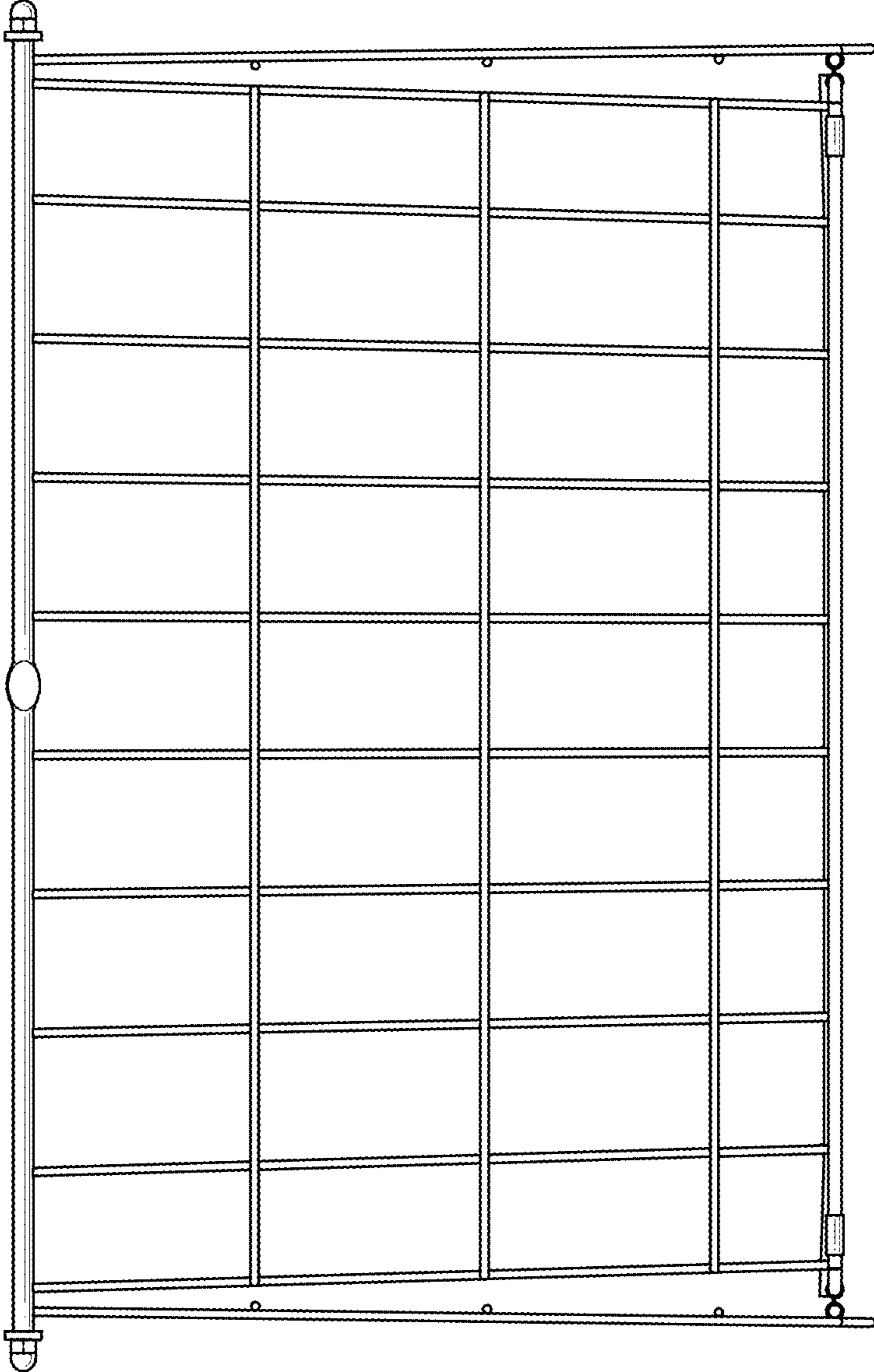

FIG.3

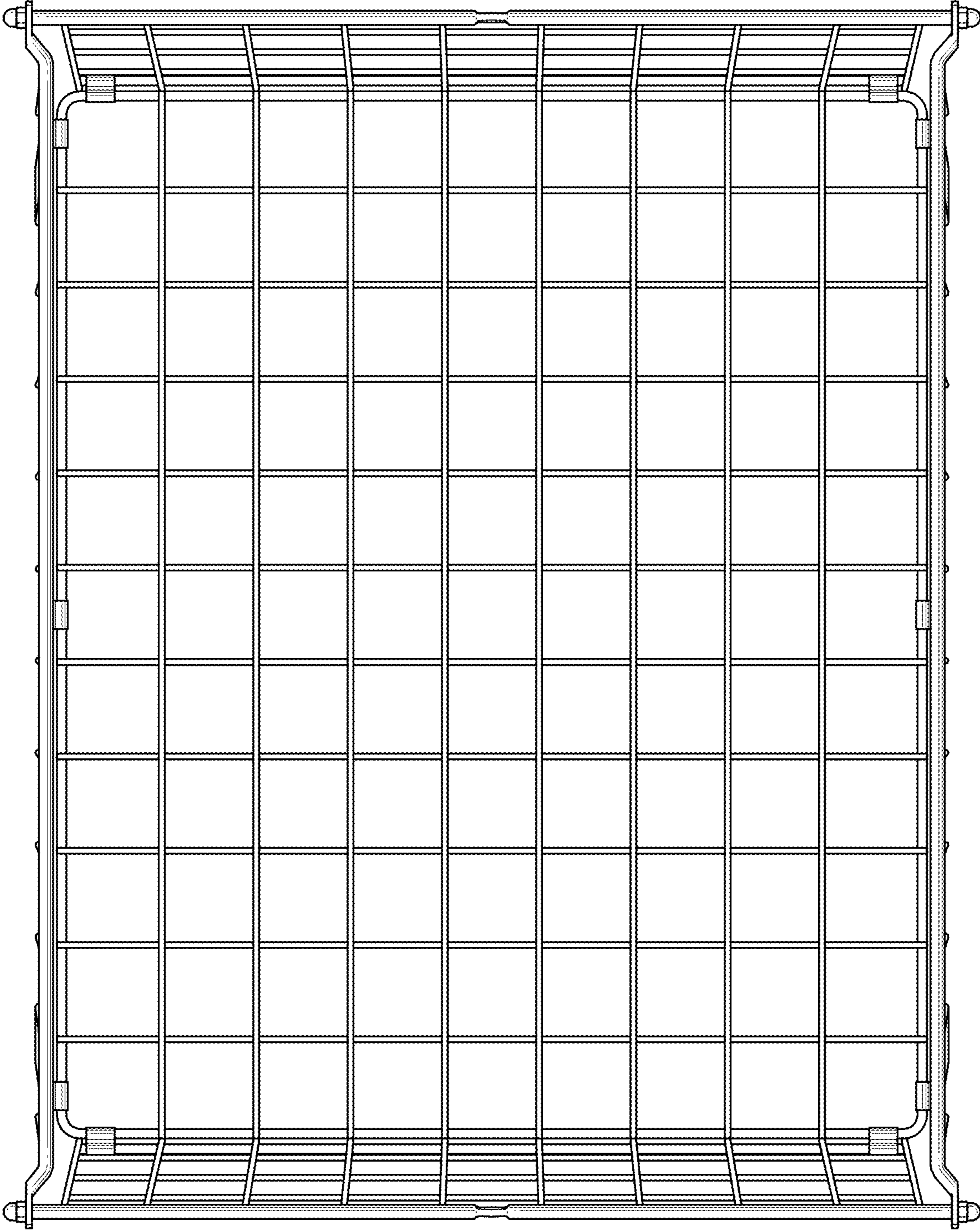

FIG.4

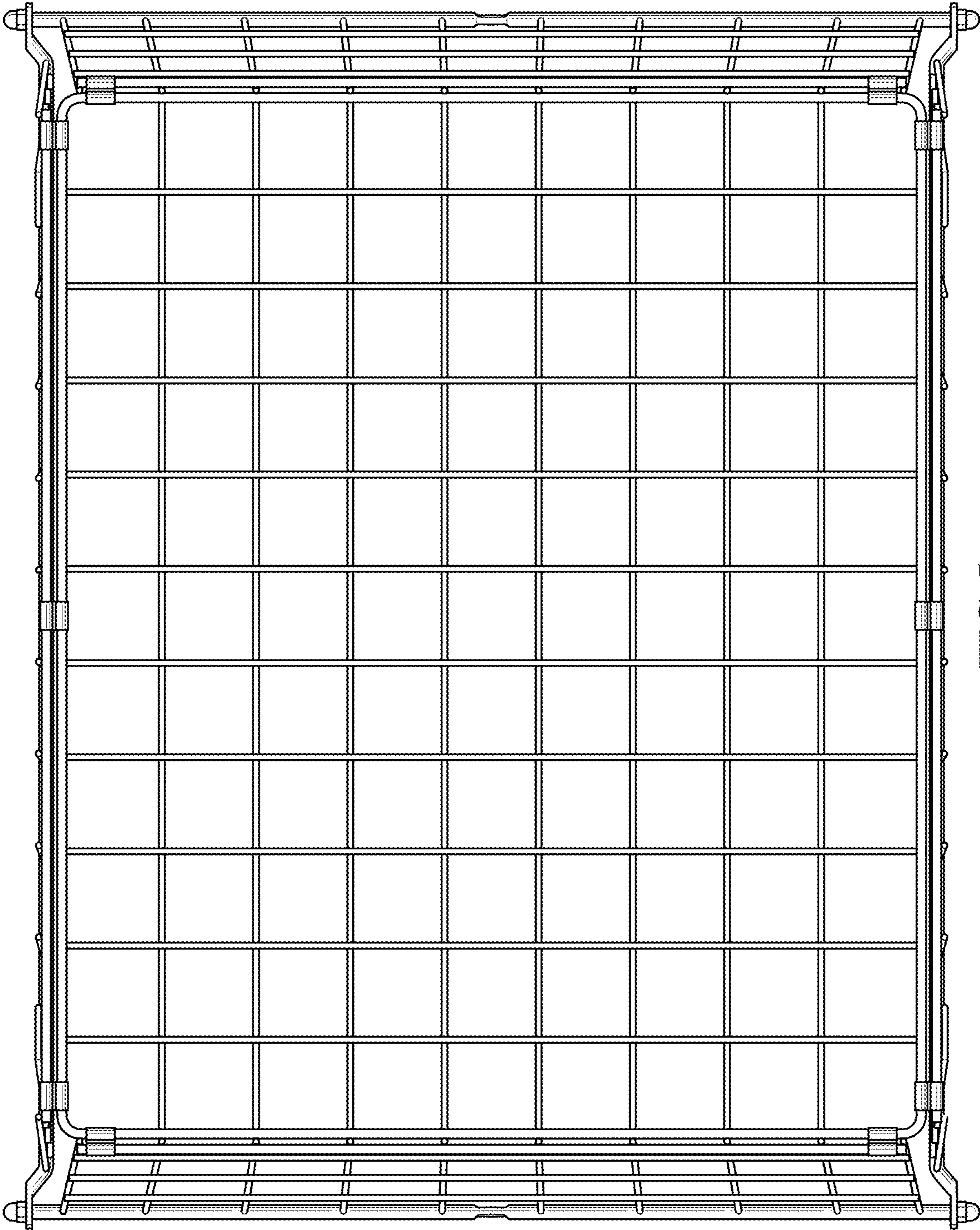

FIG.5

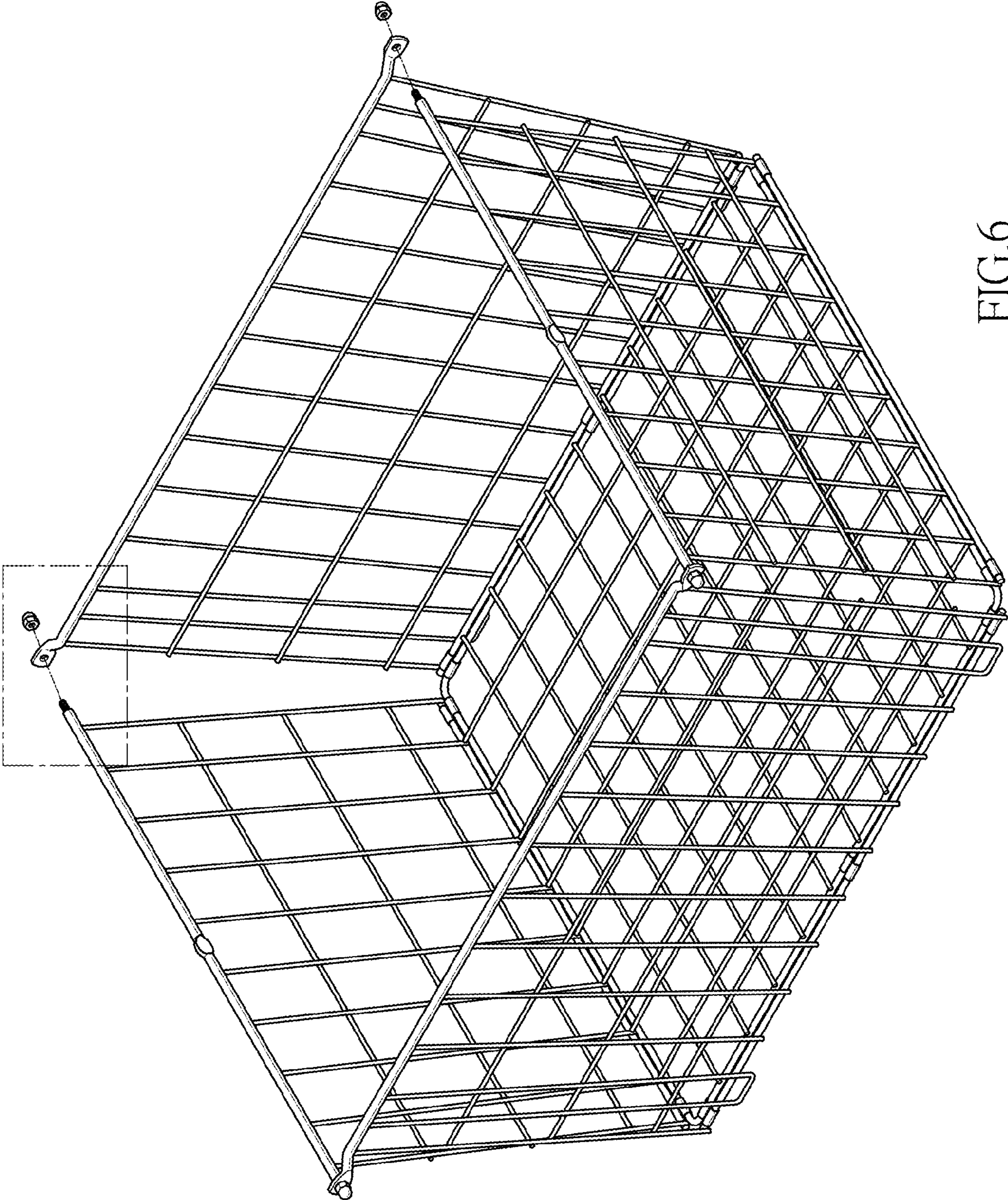

FIG.6

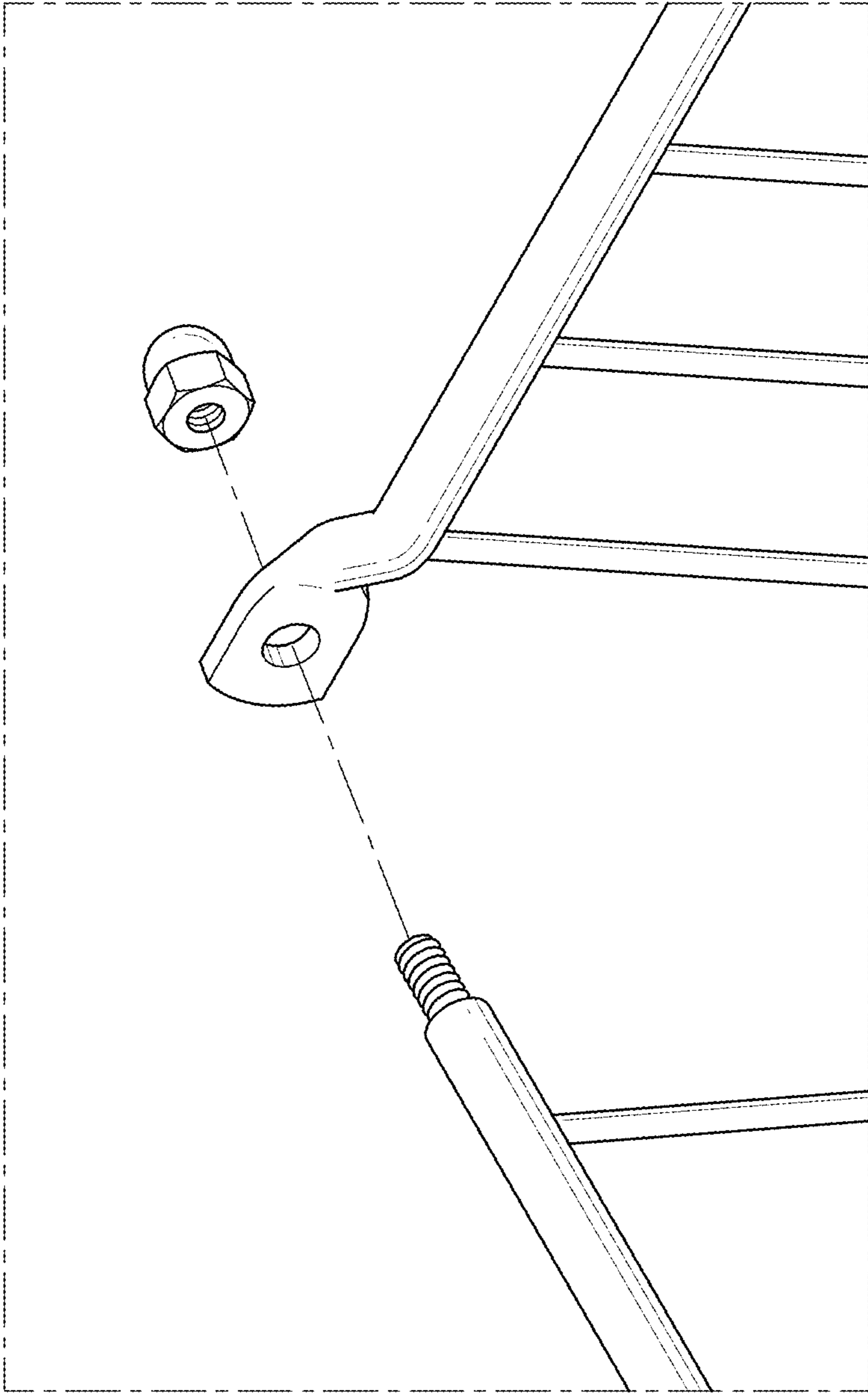

FIG.7



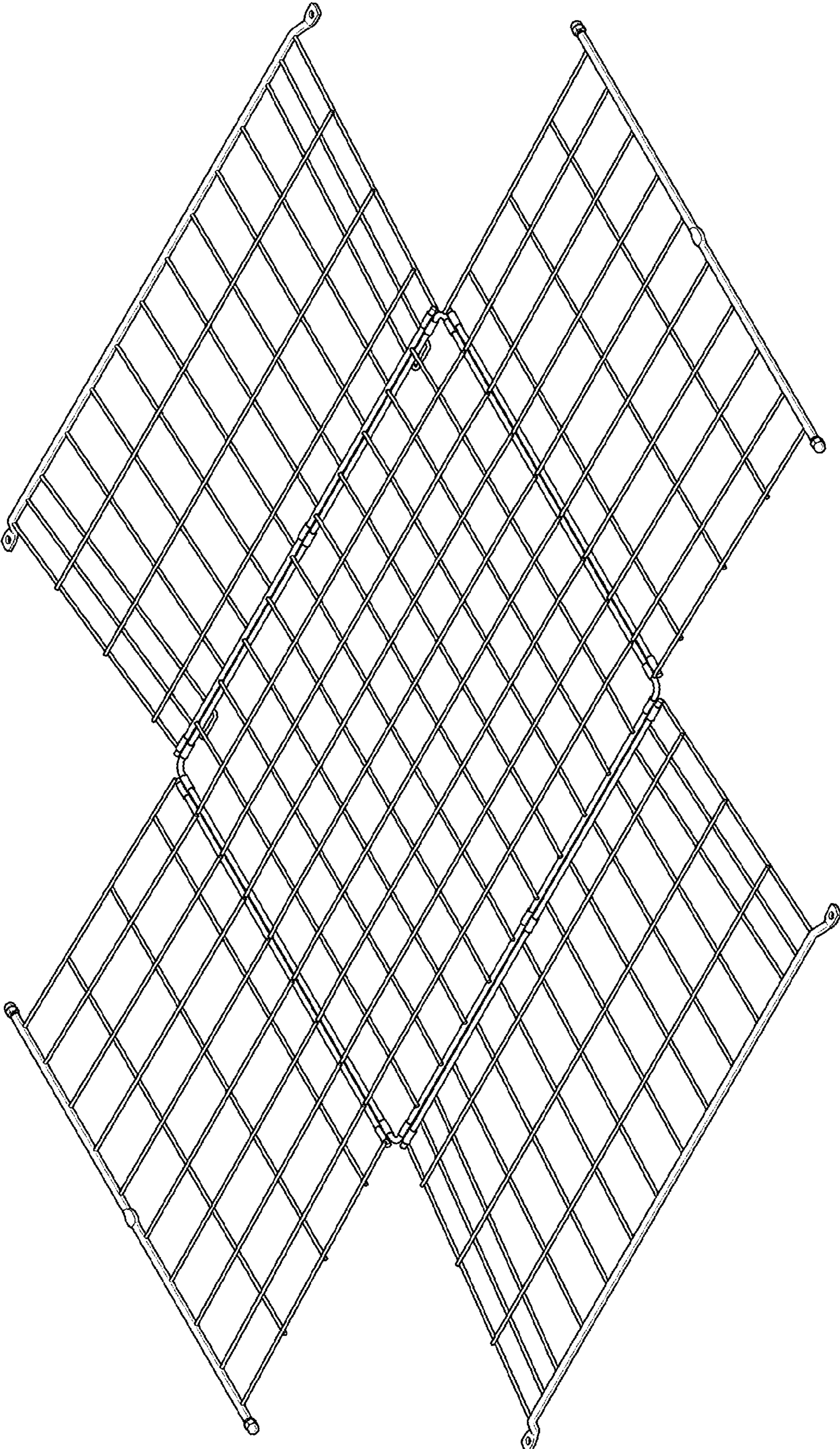

FIG. 8