



US00D973324S

(12) **United States Design Patent**
Lesecq

(10) **Patent No.:** **US D973,324 S**

(45) **Date of Patent:** **** Dec. 27, 2022**

- (54) **SHOE**
- (71) Applicant: **NIKE, Inc.**, Beaverton, OR (US)
- (72) Inventor: **Fiona L. Lesecq**, Portland, OR (US)
- (73) Assignee: **NIKE, Inc.**, Beaverton, OR (US)
- (**) Term: **15 Years**
- (21) Appl. No.: **29/832,968**
- (22) Filed: **Mar. 31, 2022**
- (51) **LOC (13) Cl.** **02-04**
- (52) **U.S. Cl.**
USPC **D2/947**; D2/906
- (58) **Field of Classification Search**
USPC D2/962, 906, 914, 915, 641-643, 999,
D2/902, 908, 925, 946-961; 36/3 B,
36/22 R, 24.5, 25 R, 28, 32 R, 590, 67 A,
36/103
CPC A43C 15/09; A43C 15/00; A43C 13/04;
A43C 15/16; A43B 5/025; A43B 5/001;
A43B 5/02; A43B 5/185; A43B 5/06
See application file for complete search history.

- D322,355 S 12/1991 Arai
- D421,833 S * 3/2000 Fallon A43B 13/223
D2/947
- D461,297 S * 8/2002 Lancon D2/954
- D476,140 S 6/2003 Jones
- D476,467 S * 7/2003 Takamoto D2/962
- D525,416 S 7/2006 Auger et al.
- D554,830 S * 11/2007 Fullum D2/907
- D554,838 S 11/2007 McClaskie

(Continued)

OTHER PUBLICATIONS

Nike Zoom Mercurial Vapor 15 Elite FG Cleats, Nike.com, [online], [site visited Aug. 15, 2022]. <URL: <https://www.nike.com/t/zoom-mercurial-vapor-15-elite-fg-firm-ground-soccer-cleats-NLZxDR/DJ4978-001>> (Year: 2022) (Year: 2022).*

(Continued)

Primary Examiner — Jonathan J Han
Assistant Examiner — Molly K. Orzechowski
(74) *Attorney, Agent, or Firm* — Banner & Witcoff, Ltd.

(57) **CLAIM**

The ornamental design for a shoe, as shown and described.

DESCRIPTION

FIG. 1 is a bottom front perspective view of a shoe showing my new design;
FIG. 2 is a bottom view thereof;
FIG. 3 is a bottom rear perspective view thereof;
FIG. 4 is a bottom front perspective view showing an alternative embodiment of my new design;
FIG. 5 is a bottom view thereof; and,
FIG. 6 is a bottom rear perspective view thereof.
The broken lines immediately adjacent to the shaded area define the bounds of the claimed design and form no part thereof. The broken lines depicting the remainder of the shoe form no part of the claimed design.

1 Claim, 6 Drawing Sheets

- (56) **References Cited**
- U.S. PATENT DOCUMENTS**
- D25,594 S 6/1896 Plant
- D61,453 S 9/1922 Todd
- D73,143 S 7/1927 Lee
- D124,715 S 1/1941 Cutler
- D147,383 S 8/1947 Shaffer
- D163,674 S 6/1951 Bovay
- 3,127,687 A 4/1964 Hollister
- D201,865 S 8/1965 Bingham, Jr. et al.
- D208,761 S 10/1967 Gottlieb
- D271,159 S 11/1983 Muller-Feigelstock
- D272,390 S 1/1984 Muller-Feigelstock
- 4,454,662 A 6/1984 Stubblefield
- D281,370 S 11/1985 Peel
- 4,590,693 A 5/1986 Kawashima et al.

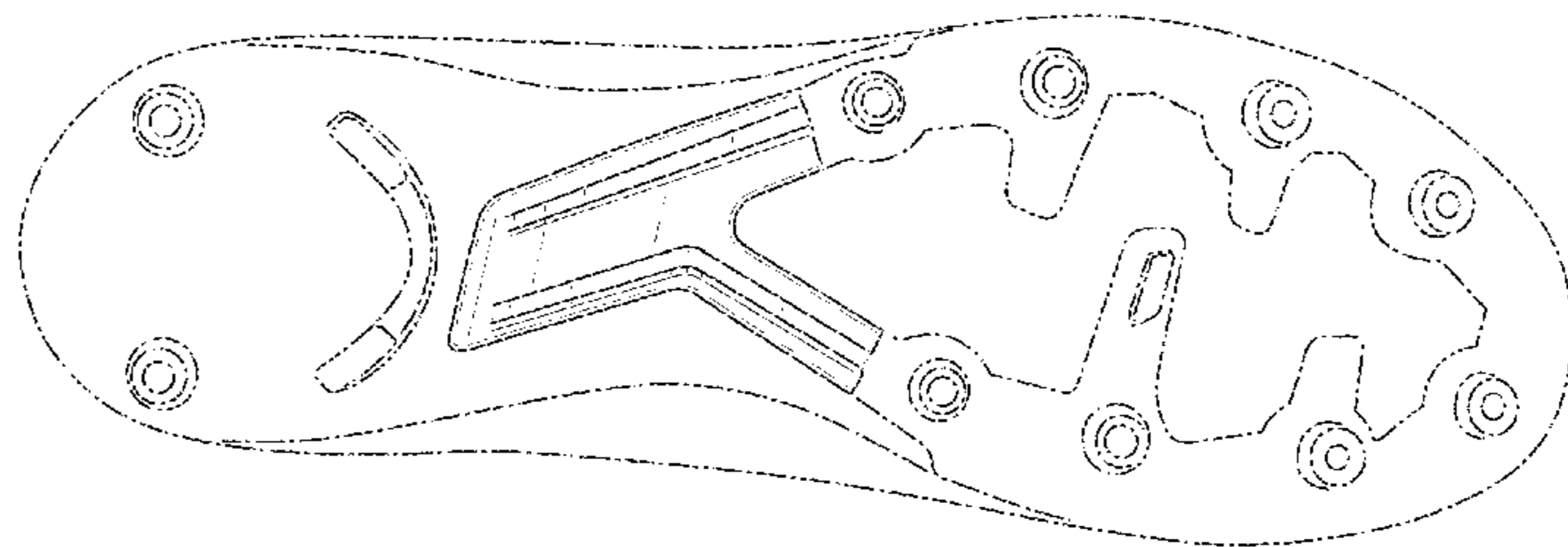
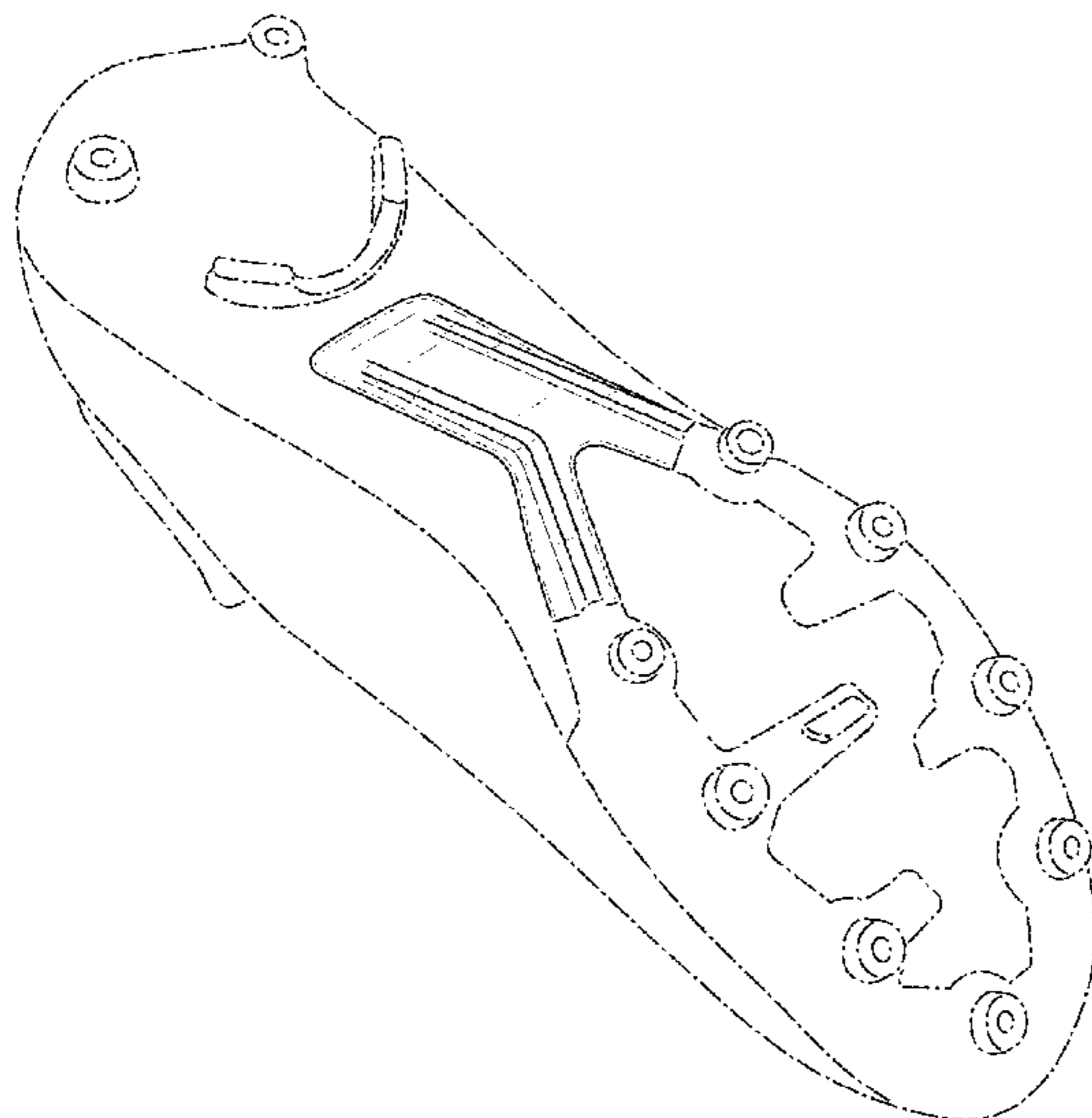

(56)

References Cited

U.S. PATENT DOCUMENTS

D556,432	S	12/2007	Gerber	
D563,637	S *	3/2008	Nakano	D2/951
D573,779	S	7/2008	Stauffer	
D574,585	S *	8/2008	Wilken	D2/951
D578,280	S *	10/2008	Wilken	A43B 13/223 D2/951
D583,542	S	12/2008	Gerber	
D590,586	S	4/2009	Harlow	
D634,108	S	3/2011	Tzenos	
D646,470	S	10/2011	Jacobs	
D649,337	S *	11/2011	Wilken	D2/951
D651,386	S	1/2012	Wilken et al.	
D667,205	S *	9/2012	Campbell	D2/962
D675,416	S	2/2013	Minami	
D688,036	S *	8/2013	Dekovic	D2/962
D688,037	S	8/2013	Dekovic et al.	
D707,428	S *	6/2014	Seamarks	D2/947
9,032,645	B2 *	5/2015	Stauffer	A43C 15/162 36/67 R
D735,982	S	8/2015	Pauk	
D778,556	S	2/2017	Lee et al.	
D778,557	S	2/2017	Lee et al.	
D779,803	S	2/2017	Lee	
D783,248	S	4/2017	Woodman	
D788,428	S	6/2017	Raysse	
D788,429	S	6/2017	Carmi	
9,820,529	B2 *	11/2017	Droege	A43B 13/12
D812,876	S *	3/2018	Gibson	D2/951
D815,409	S *	4/2018	Sokol	D2/951
D821,717	S	7/2018	Howe	
10,028,551	B2 *	7/2018	Cavaliere	A43B 13/26
D836,895	S *	1/2019	Taylor	D2/951
D838,951	S *	1/2019	Lee	D2/951
D840,141	S *	2/2019	Hui	D2/951
D846,852	S	4/2019	Lee	
D862,858	S *	10/2019	Roman	D2/947
D864,545	S *	10/2019	Stewart	D2/962
D866,939	S	11/2019	Small	
D869,833	S	12/2019	Hartmann et al.	
D870,433	S	12/2019	Hartmann et al.	
D872,984	S *	1/2020	de Montgolfier	D2/951
D879,424	S	3/2020	Hartmann et al.	
D880,120	S *	4/2020	Fick	D2/947
D893,149	S *	8/2020	de Montgolfier	D2/951
D901,142	S *	11/2020	Strek	D2/962
D902,551	S	11/2020	Lee	
D903,269	S	12/2020	Lee	
D903,270	S	12/2020	Lee	
D912,953	S *	3/2021	Belhacene	D2/954
D913,663	S *	3/2021	Essilfie-Taylor	D2/947
D928,486	S *	8/2021	Roman	D2/947
D929,099	S *	8/2021	Rémy	D2/962
D931,590	S *	9/2021	Belhacene	D2/962
D934,545	S	11/2021	Holmes	
D940,444	S *	1/2022	Wilkinson	D2/962
D954,411	S *	6/2022	Belhacene	D2/951
D955,712	S *	6/2022	Gao	D2/951
D956,398	S *	7/2022	Roman	D2/947
D956,400	S *	7/2022	Roman	D2/947
D957,799	S *	7/2022	Ding	D2/953
2009/0100718	A1 *	4/2009	Gerber	A43C 15/04 36/67 A
2013/0333248	A1 *	12/2013	Auger	A43B 3/0052 36/134
2016/0353838	A1 *	12/2016	Takeshita	A43B 7/142

OTHER PUBLICATIONS

Nike Zoom Mercurial Superfly 9 Academy MG Cleats, Nike.com, [online], [site visited Aug. 15, 2022]. <URL: <https://www.nike.com/t/zoom-mercurial-superfly-9-academy-mg-multi-ground-soccer-cleats-ch3q5s/DJ5625-343>> (Year: 2022) (Year: 2022).*

Under Armour Corespeed Force 2.0 FG Clutch Fit Cleats, Sears.com, [online], [site visited Aug. 26, 2022]. <URL: <https://www.sears.com/under-armour-corespeed-force-2.0-fg-mens-soccer/p-A028469561>> (Year 2018) (Year: 2018).*

Nike Footwear Catalog, 1995 Fall Footwear, p. 69, published Mar. 1994, Nike, Inc., USA.

Nike Footwear Catalog, 1995 Fall Footwear, p. 82, published Mar. 1994, Nike, Inc., USA.

Nike Footwear Catalog, 1998 Late Spring Footwear, p. M110, published Mar. 1998, Nike, Inc., USA.

Nike Footwear Catalog, 2009 Fall Sport Performance Footwear, p. 78, published Nov. 2008, Nike, Inc., USA.

Nike Footwear Catalog, 2019 Spring Football/Soccer, p. 30, published date unknown, but prior to the filing date of the present application, Nike, Inc., USA.

Nike Footwear Catalog, 2019 Spring Football/Soccer, p. 51, published date unknown, but prior to the filing date of the present application, Nike, Inc., USA.

U.S. Appl. No. 29/832,990, filed Mar. 31, 2022.

“Nike Hypervenom Phantom 3 DF—Boot Review”; Soccer Cleats 101; retrieved Mar. 29, 2022; published Feb. 20, 2017; URL: <<https://www.soccercleats101.com/2017/02/20/nike-hypervenom-phantom-3-df-boot-review/>>.

“Virgil Abloh’s Off White Designs Special Colorway Of The Nike Vapor 12 Elite Soccer Cleat”; Sneaker News; retrieved Jul. 23, 2020; published Mar. 5, 2018; URL: <<https://sneakernews.com/2018/03/05/off-white-virgil-abloh-nike-vapor-12-elite-soccer-cleat-orange/>>.

“Nike Mercurial Superfly 360 Review: The best speed boot”; Boot Hype; retrieved Mar. 29, 2022; published May 12, 2018; URL: <<https://boothype.com/2018/12/05/review-nike-mercurial-superfly-360-elite/>>.

“Deep Dive Instep Review: Nike Mercurial Vapor 13”; Soccer Pro—The Instep; retrieved Mar. 29, 2022; published Jul. 30, 2019; URL: <<https://www.soccerpro.com/theinstep/deep-dive-instep-review-nike-mercurial-vapor-13/>>.

“Nike Mercurial Vapor 13 Pro Indoor New Lights Pack Review”; Soccer Reviews For You; retrieved Aug. 25, 2021; published Aug. 1, 2019; URL: <<https://soccerreviewsforyou.com/2019/08/nike-mercurial-vapor-13-pro-indoor-new-lights-pack-review/>>.

“Laced Up: Nike Mercurial Superfly 7 Review”; Soccer Bible; retrieved Jul. 23, 2020; published Aug. 22, 2019; URL: <<https://www.soccerbible.com/performance/football-boots/2019/08/laced-up-nike-mercurial-superfly-7-review/>>.

“Nike Mercurial Vapor 13 Elite Boot Review”; Soccer Cleats 101; retrieved Jul. 23, 2020; published Oct. 3, 2019; URL: <<https://www.soccercleats101.com/2019/10/03/nike-mercurial-vapor-13-elite-boot-review/>>.

“What Nike Mercurial Should You Buy?”; Soccer.com; retrieved Aug. 25, 2021; published Feb. 25, 2021; URL: <<https://www.soccer.com/guide/nike-mercurial-tiers>>.

“Nike Unisex-Adult Superfly 8 Academy Sg-pro Ac Soccer Shoe”; Amazon; retrieved Aug. 25, 2021; published date unknown, but prior to application filing date; URL: <<https://www.amazon.com/Nike-Unisex-Adult-Superfly-Academy-Sg-pro/dp/B08QB3TCS3?th=1>>.

“Nike Mercurial Superfly 8 Academy TF”; Nike; retrieved Aug. 25, 2021; published date unknown, but prior to application filing date; URL: <<https://www.nike.com/t/mercurial-superfly-8-academy-tf-turf-soccer-shoes-nWW4Kf/CV0953-760>>.

“Nike Mercurial Vapor 14 Academy AG”; R-GOL; retrieved Aug. 25, 2021; published date unknown, but prior to application filing date; URL: <<https://www.r-gol.com/en/nike-mercurial-vapor-14-academy-ag,p-141648>>.

“Nike Jr. Mercurial Vapor 13 Academy TF Little/Big Kids’ Artificial-Turf Soccer Shoe”; Best Buy Soccer; retrieved Aug. 25, 2021; published date unknown, but prior to application filing date; URL: <<https://www.bestbuysoccer.com/nike-jr-mercurial-vapor-13-academy-tf-little-big-kids-artificial-turf-soccer-shoe.html#color=1907&Size=1954>>.

“Nike Mercurial Superfly 7 Elite MDS FG”; Nike; retrieved Jul. 23, 2020; published date unknown, prior to Jul. 23, 2020; URL: <<https://www.nike.com/t/mercurial-superfly-7-elite-mds-fg-firm-ground-soccer-cleat-Xgb9Qw>>.

(56)

References Cited

OTHER PUBLICATIONS

“Nike Phantom Venom Academy FG”; Soccer Village; retrieved Mar. 29, 2022; published date unknown, but prior to application filing date; URL: <<https://www.soccervillage.com/ao0566-810.html>>.

* cited by examiner

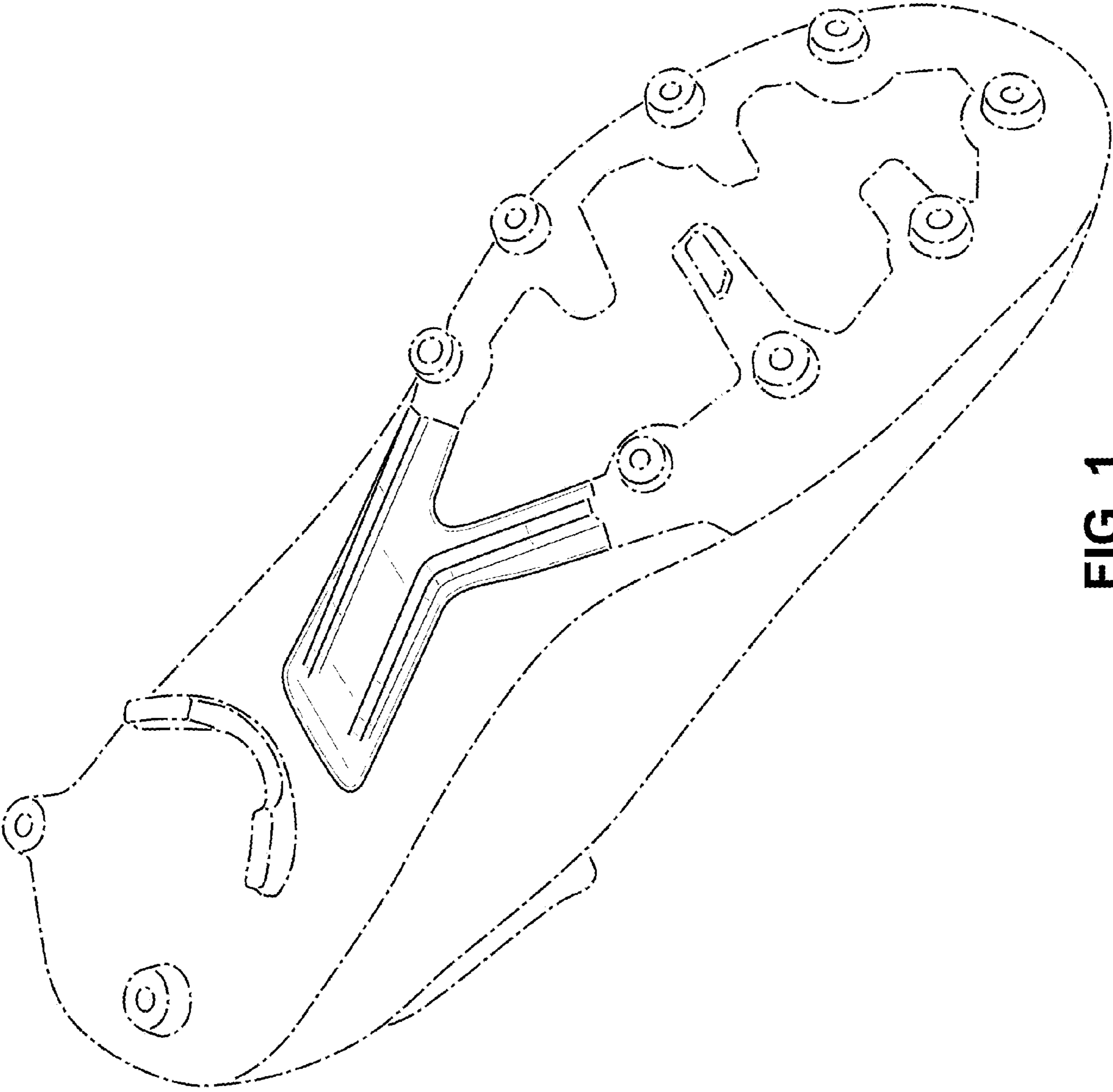

FIG. 1

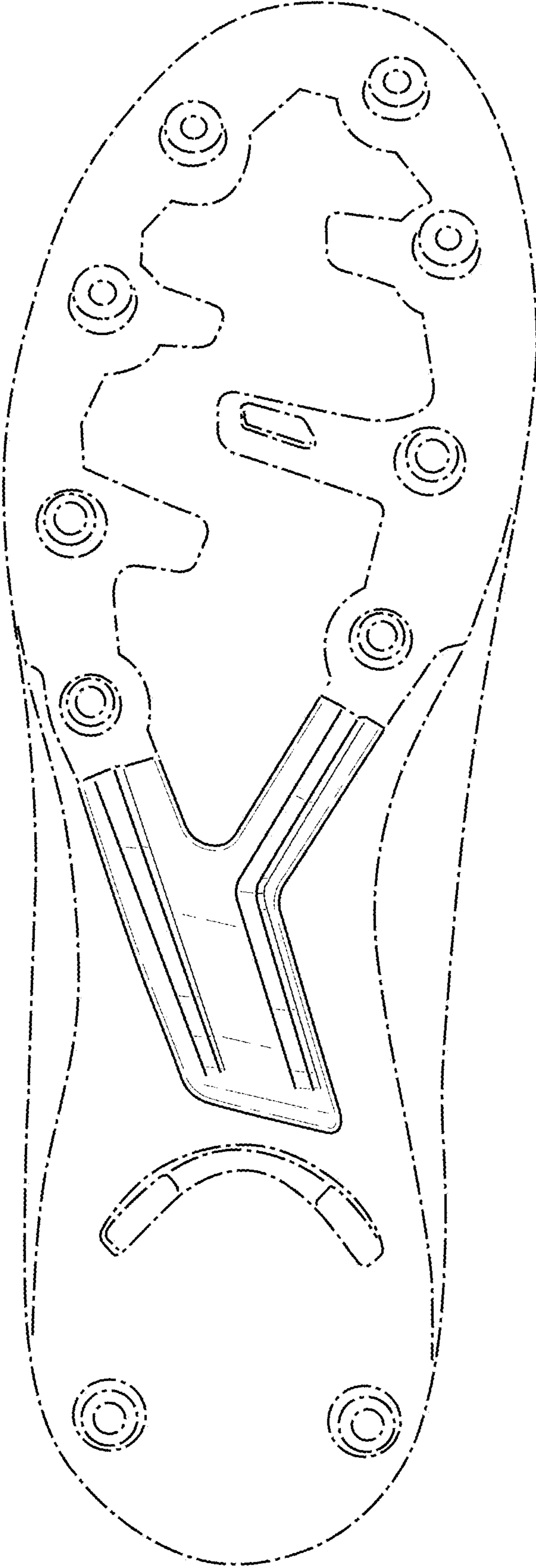

FIG. 2

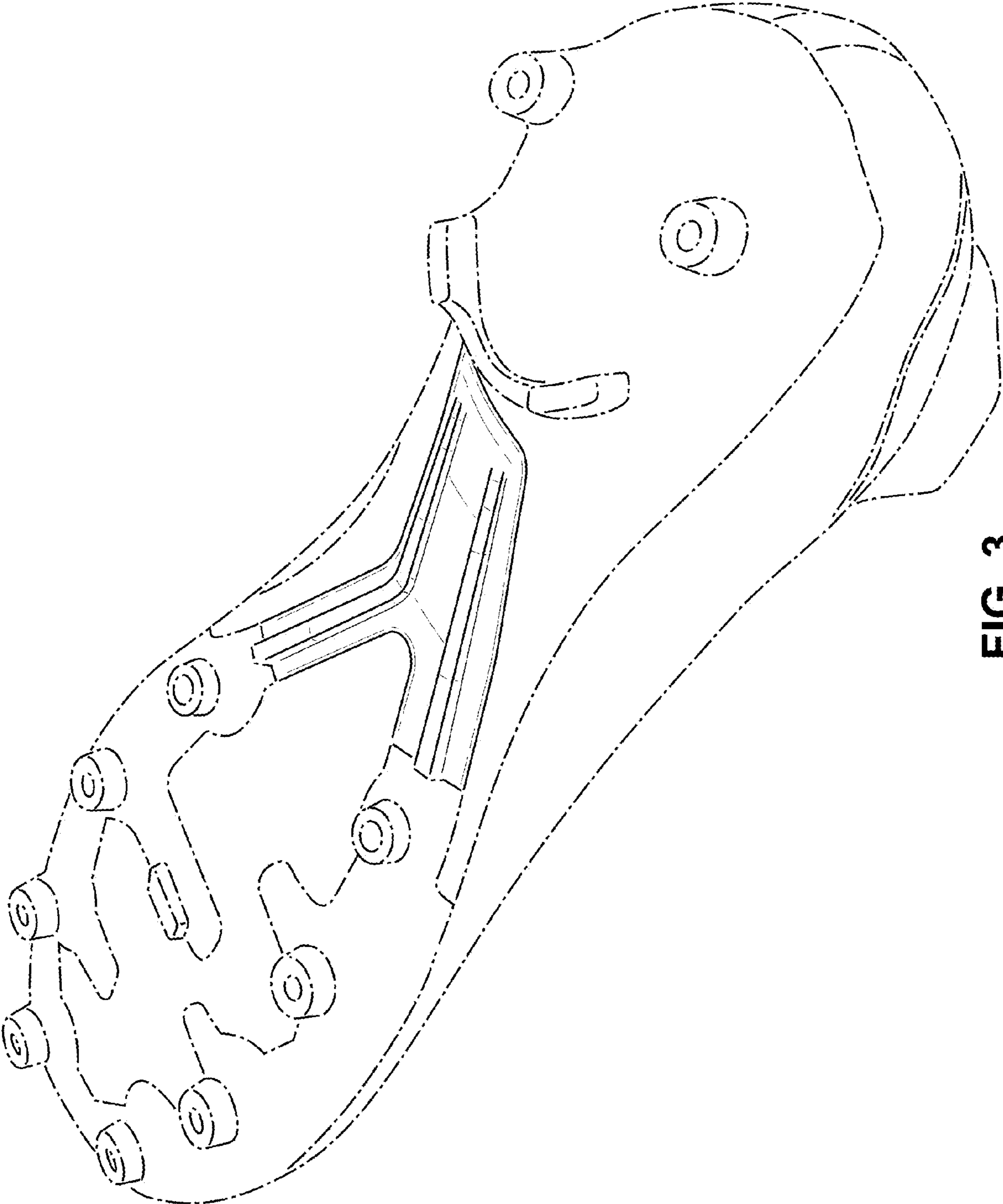

FIG. 3

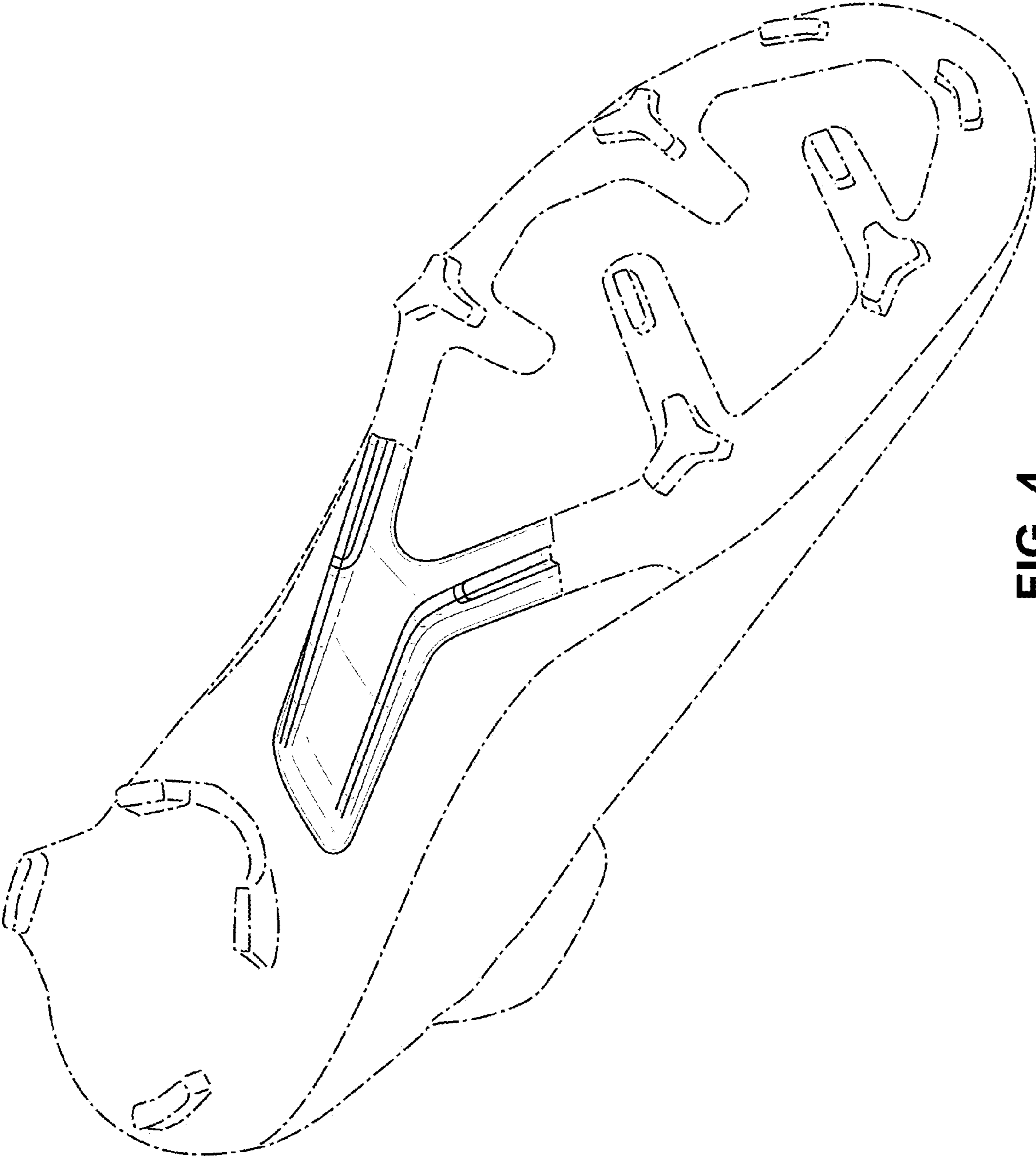

FIG. 4

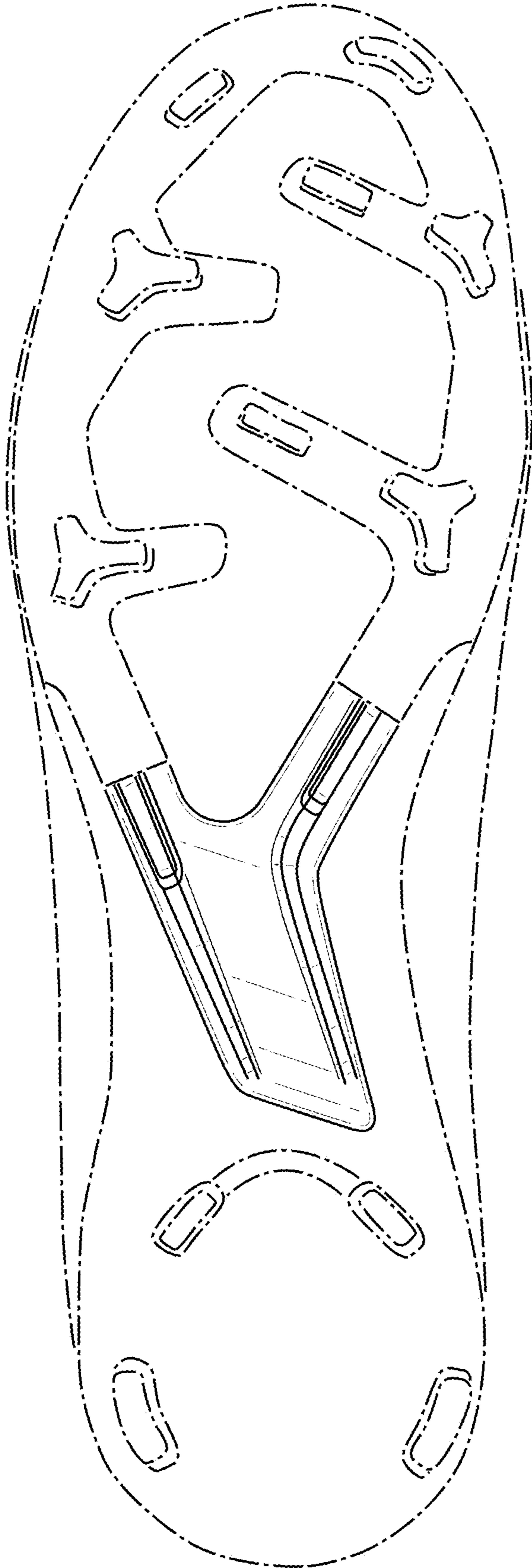

FIG. 5

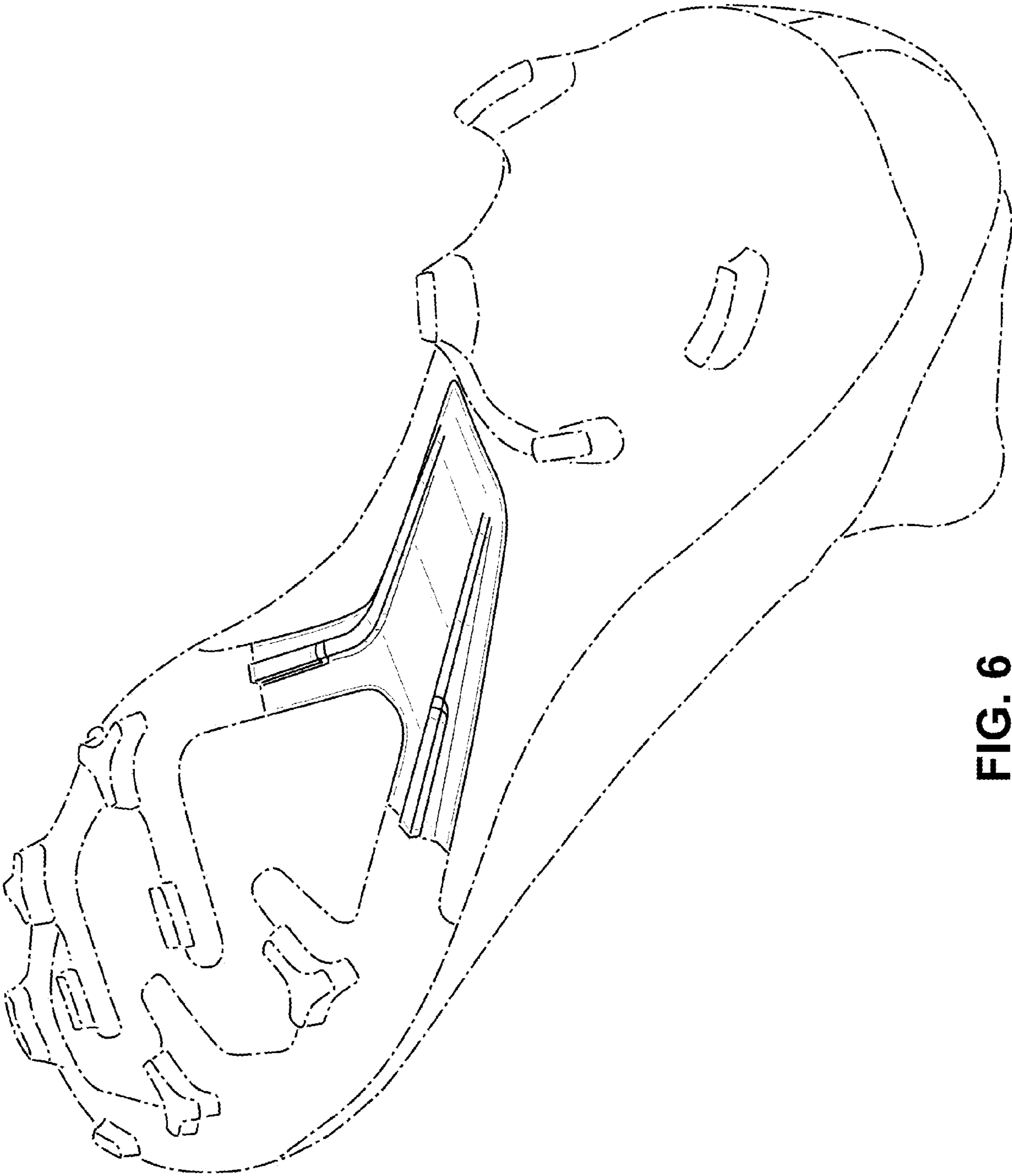

FIG. 6