



US00D973304S

(12) **United States Design Patent** (10) **Patent No.:** **US D973,304 S**
Lassila (45) **Date of Patent:** **** Dec. 27, 2022**

- (54) **WRIST BAND**
- (71) Applicant: **Coaching Band LLC**, Mercer Island, WA (US)
- (72) Inventor: **Lara B. Lassila**, Mercer Island, WA (US)
- (73) Assignee: **Coaching Band LLC**, Mercer Island, WA (US)
- (**) Term: **15 Years**
- (21) Appl. No.: **29/803,574**
- (22) Filed: **Aug. 13, 2021**
- (51) **LOC (13) Cl.** **02-06**
- (52) **U.S. Cl.**
USPC **D2/610**
- (58) **Field of Classification Search**
USPC D2/623, 610; D29/120.1
CPC A41D 20/00
See application file for complete search history.

- 9,468,243 B2 10/2016 Rothschild et al.
 - D785,318 S 5/2017 Holmes
 - D785,924 S * 5/2017 Blythe D2/999
 - 10,080,950 B2 9/2018 Kelley
 - D847,133 S * 4/2019 Catania D14/344
- (Continued)

OTHER PUBLICATIONS

Handy Socks Cotton Wrist Bands, posted at alibaba.com, posting date not given, [online], [site visited Aug. 17, 2022]. Available from Internet, URL: https://www.alibaba.com/product-detail/Table-tennis-badminton-cotton-basketball-squash_50042099217.html (Year: 2022).*

(Continued)

Primary Examiner — Maria J. Edwards
(74) *Attorney, Agent, or Firm* — Shook, Hardy & Bacon LLP

(57) **CLAIM**

The ornamental design for a wrist band, as shown and described.

DESCRIPTION

FIG. 1 is a perspective view of a wrist band showing my new design;
FIG. 2 is a front view thereof;
FIG. 3 is a back view thereof;
FIG. 4 is a first side view thereof;
FIG. 5 is an opposite second side view thereof;
FIG. 6 is a top plan view, with the bottom plan view being a mirror image thereof; and,
FIG. 7 is a perspective view thereof, shown in a configuration of use.
The even-length broken lines are directed to environment, represent unclaimed subject matter, and form no part of the claimed design. In FIG. 7, the even-length broken line showing a human hand and arm is for illustrative purposes only and forms no part of the claimed design.

1 Claim, 5 Drawing Sheets

- (56) **References Cited**
- U.S. PATENT DOCUMENTS**
- 2,643,389 A * 6/1953 Wegner A41D 20/00
2/170
- 4,158,342 A 6/1979 Scruggs
- 4,557,215 A 12/1985 Petersson
- 5,263,866 A 11/1993 Campbell
- 5,704,067 A 1/1998 Brady
- D438,374 S 3/2001 Hayman
- 6,443,341 B1 9/2002 Rittmann
- 6,464,507 B1 10/2002 Bailey
- D569,577 S * 5/2008 Barker D2/614
- 8,126,143 B2 2/2012 Daniel et al.
- D661,275 S * 6/2012 Roka D10/31
- 8,845,461 B2 9/2014 Duke
- D722,903 S 2/2015 Rimsky
- D740,495 S * 10/2015 Ramos D29/120.1
- D749,315 S * 2/2016 Ross D3/215

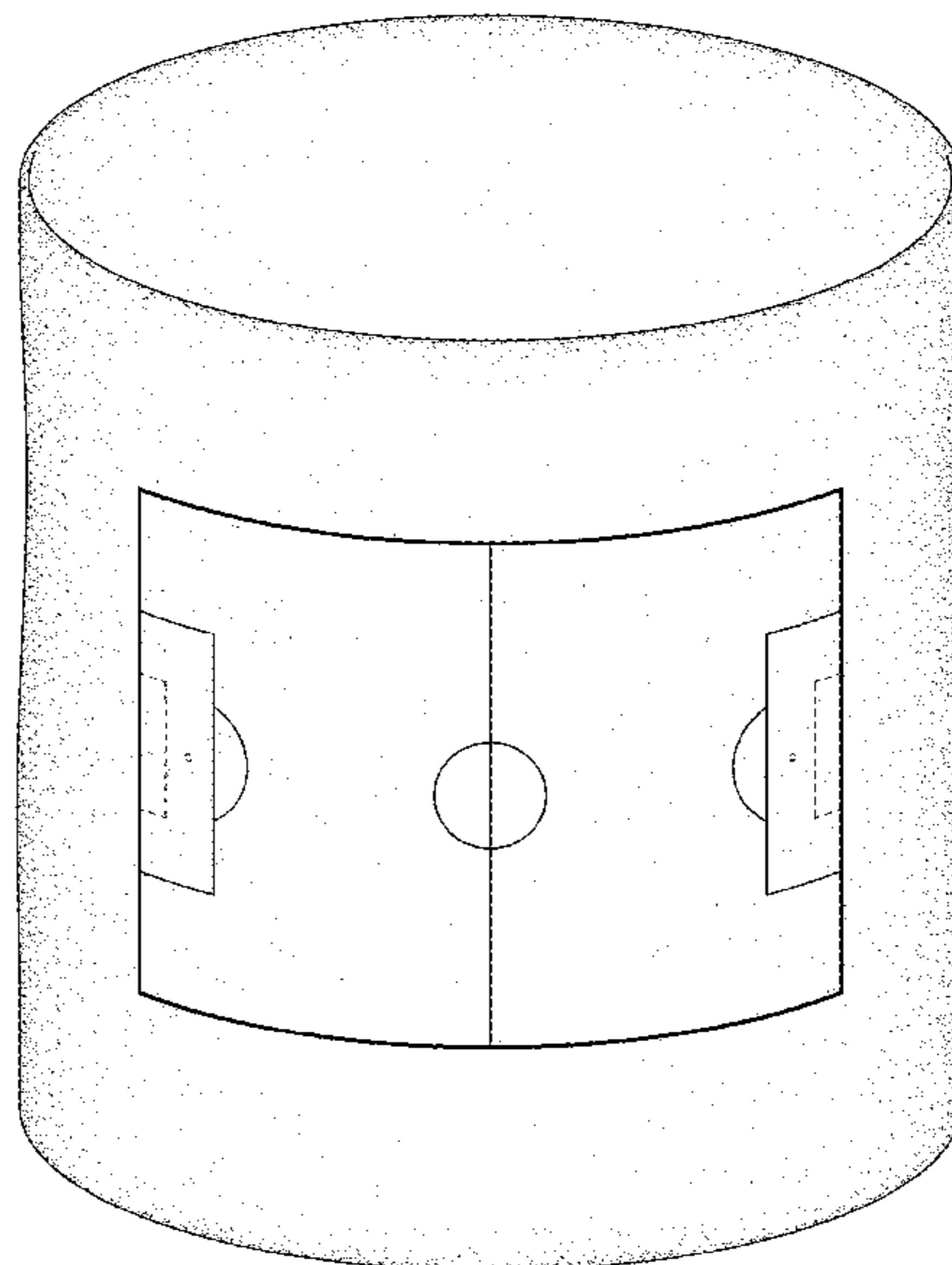

(56)

References Cited

U.S. PATENT DOCUMENTS

D858,937 S * 9/2019 Sweeting D2/610
10,532,266 B2 1/2020 Genova
10,743,594 B2 8/2020 Vann
D915,761 S * 4/2021 Blythe D2/999
D919,229 S * 5/2021 Bryngelson D2/610
2007/0290801 A1 12/2007 Powell
2008/0261187 A1 10/2008 Pierce
2010/0255451 A1 10/2010 Shapiro
2011/0167536 A1 7/2011 Kellerhals
2012/0055963 A1 3/2012 Phair
2014/0093850 A1 4/2014 Georgi
2016/0129328 A1 5/2016 Findlay
2020/0029636 A1* 1/2020 Kelly A41D 20/00

OTHER PUBLICATIONS

Soccer Formation Wrist Band, posted at [stumblingsgoat.com](https://www.stumblingsgoat.com), posting date not given, [online], [site visited Aug. 17, 2022]. Available from Internet, URL: <https://www.stumblingsgoat.com/products/soccer-7x7-coaching-bands-names> (Year: 2022).*

Playbook Wristband—Youth—Black, [flagfootballplans.com](https://www.flagfootballplans.com).

Nike Youth Pro Combat Dri-Fit Football Playcoach, [sportsunlimitedinc.com](https://www.sportsunlimitedinc.com).

* cited by examiner

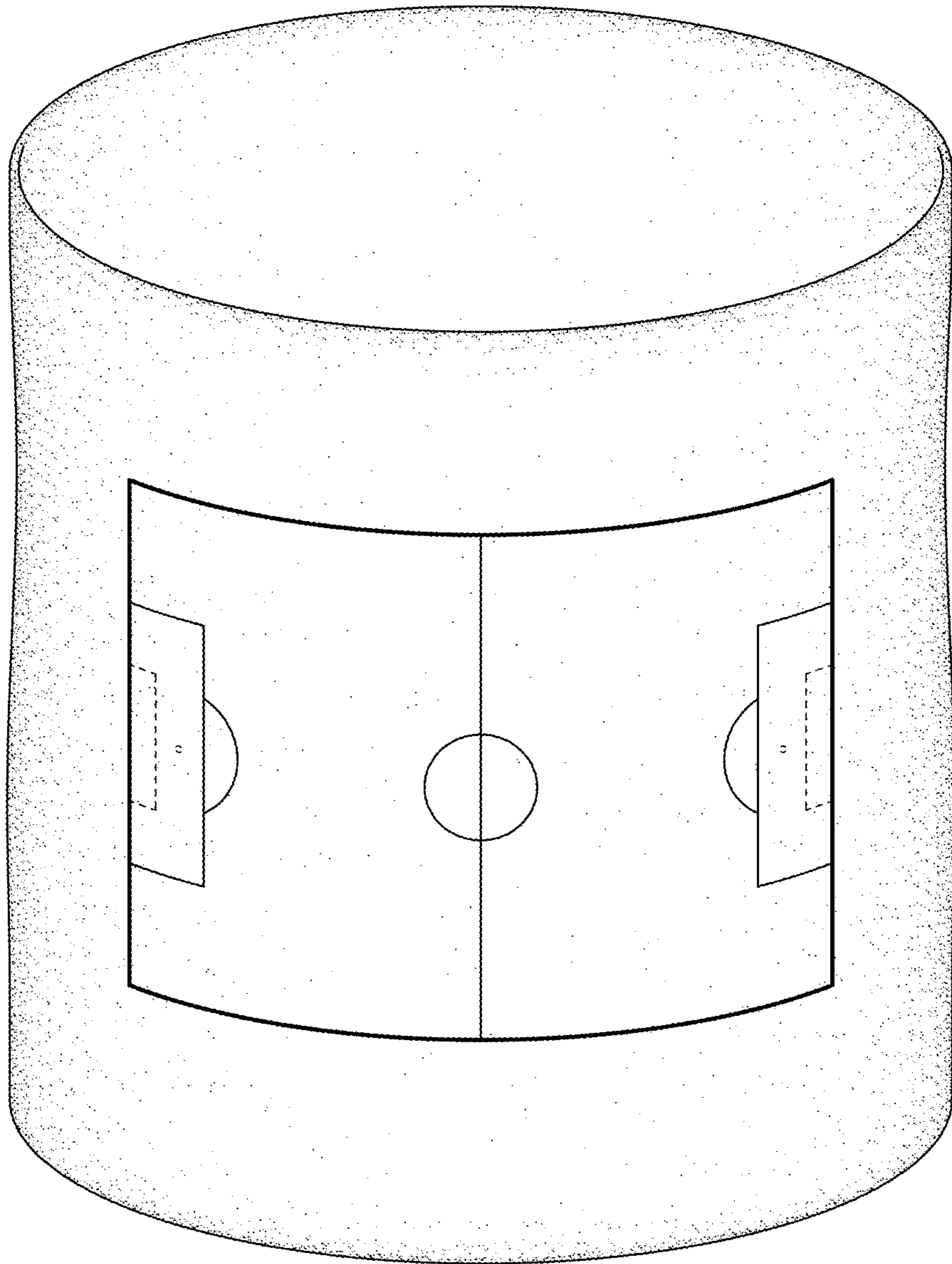

FIG. 1

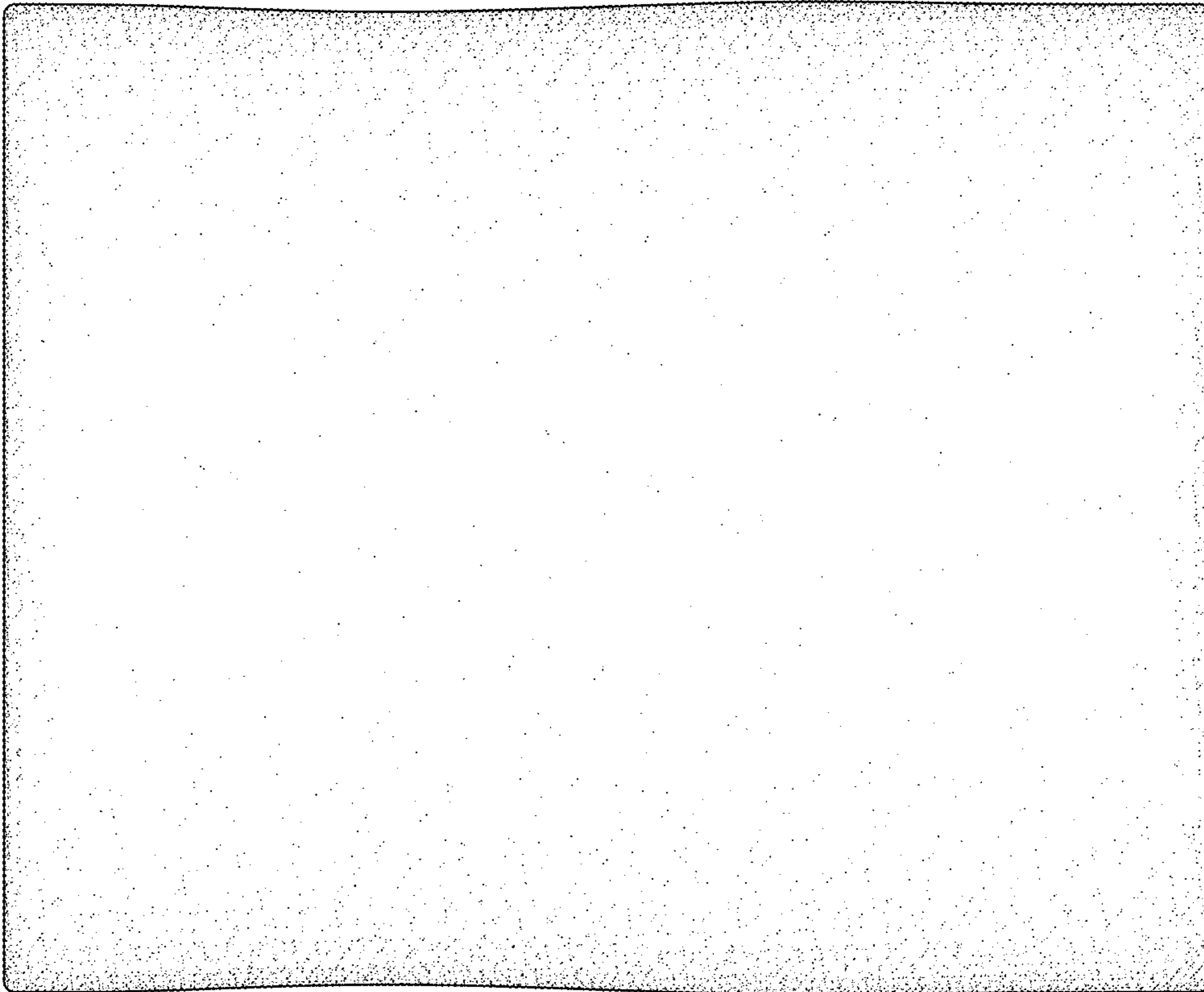

FIG. 3

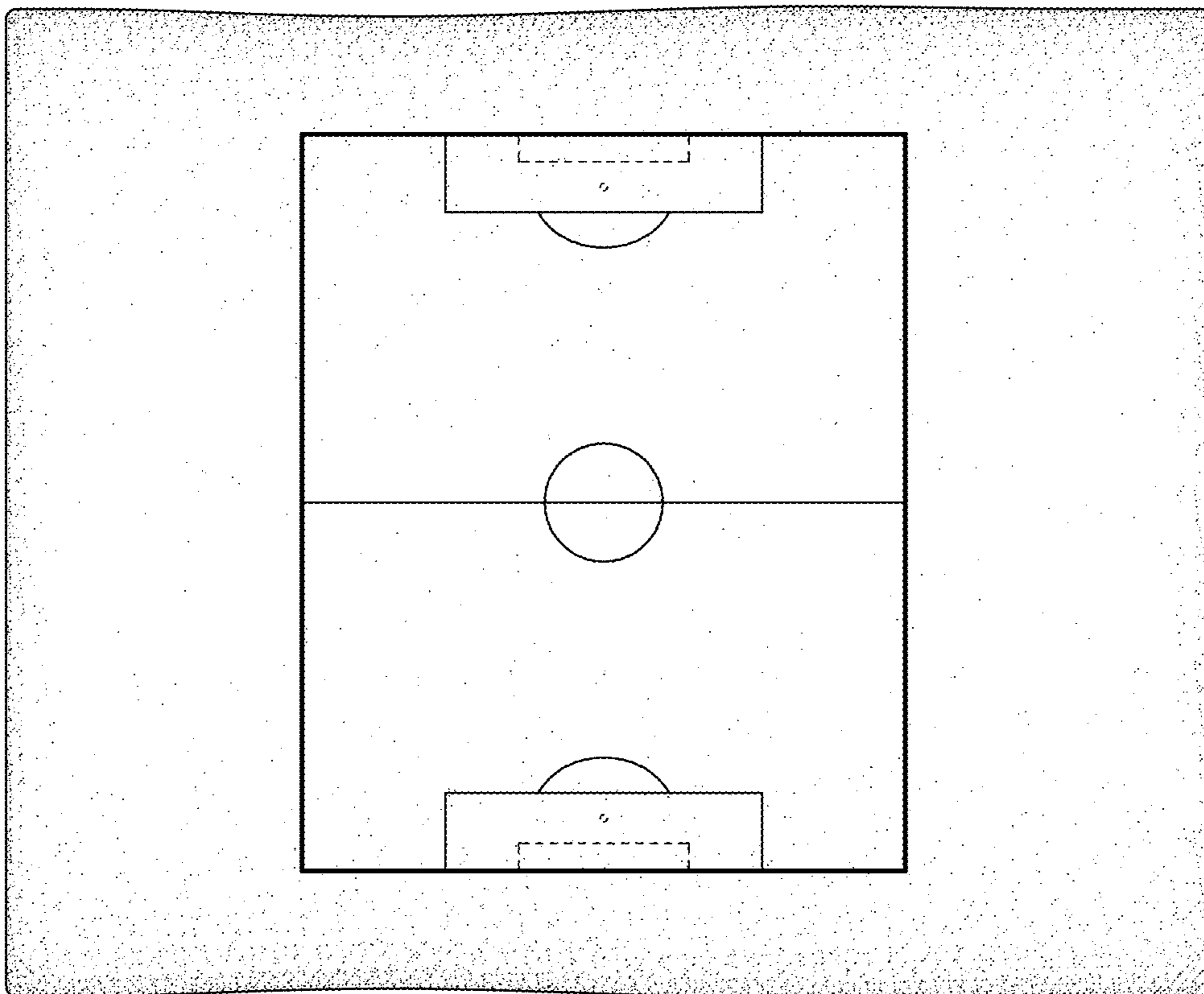

FIG. 2

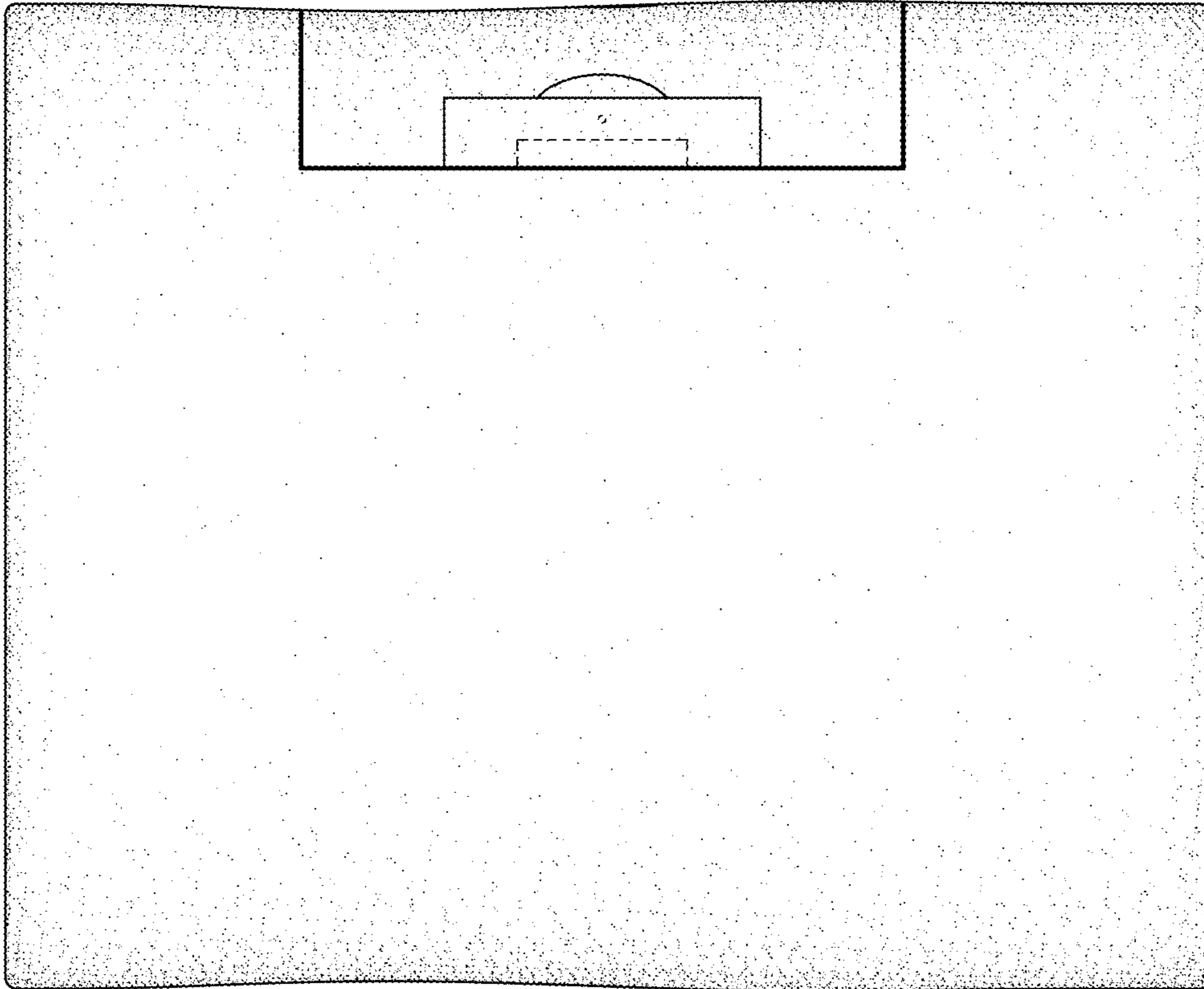

FIG. 5

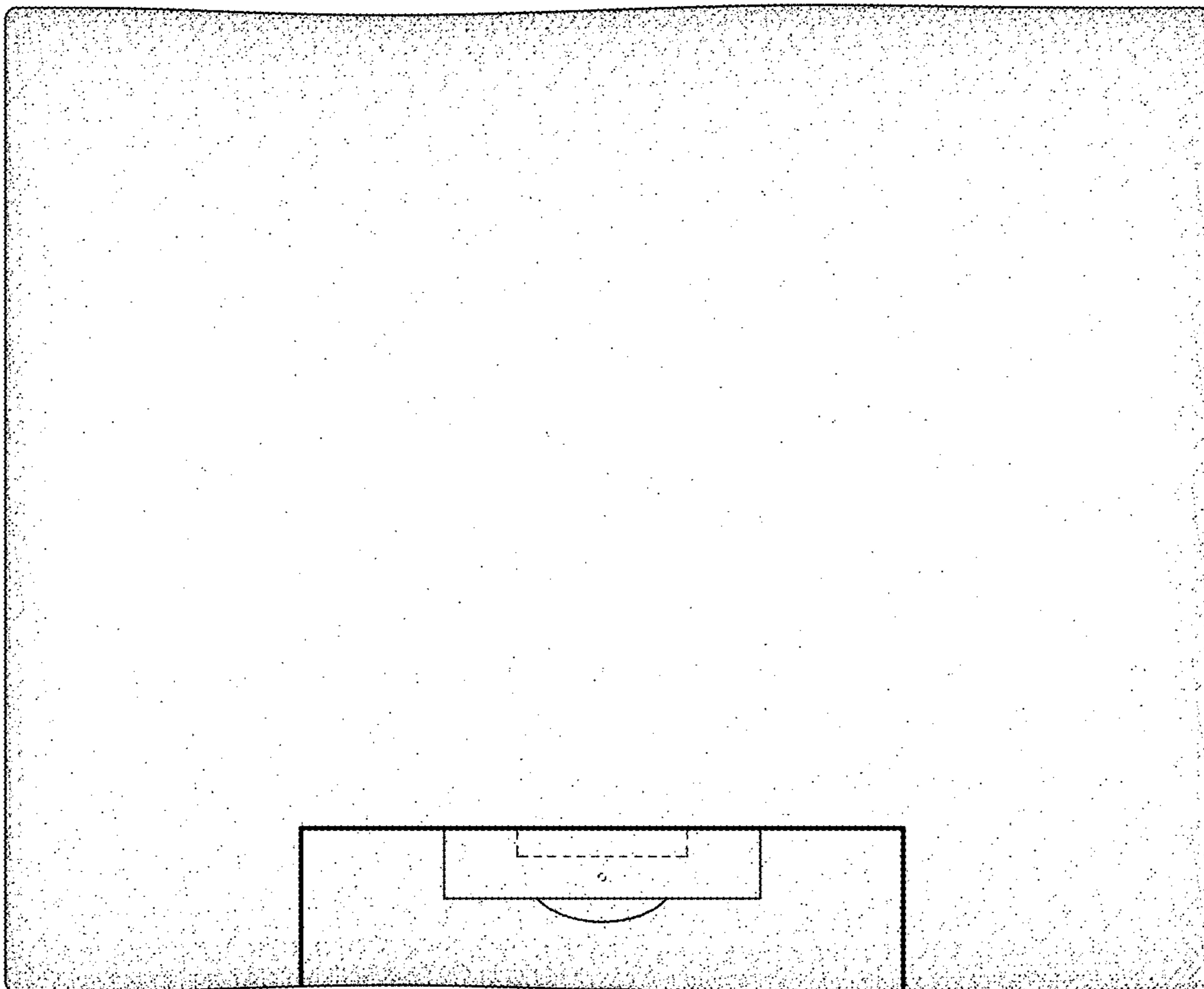

FIG. 4

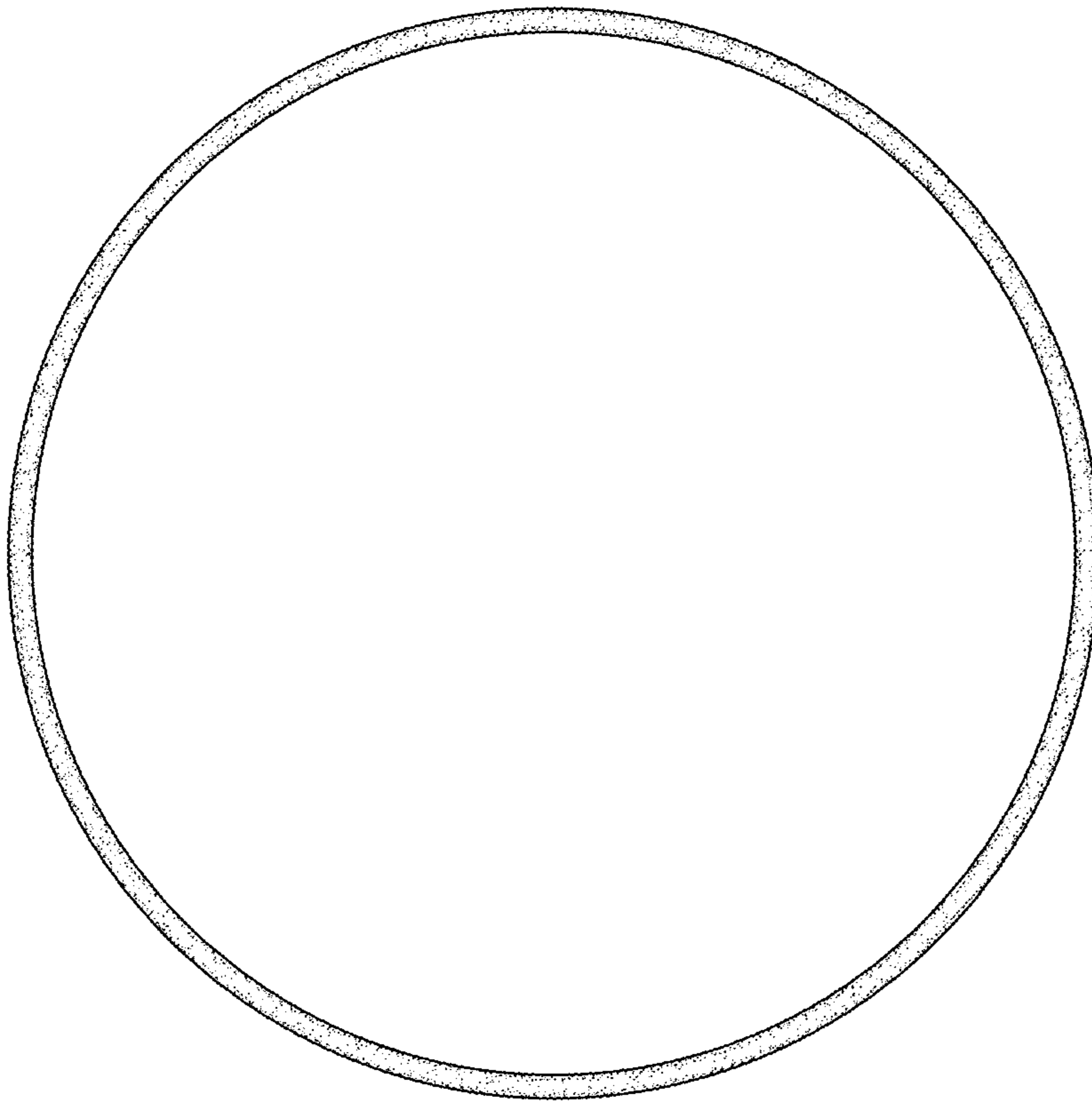

FIG. 6

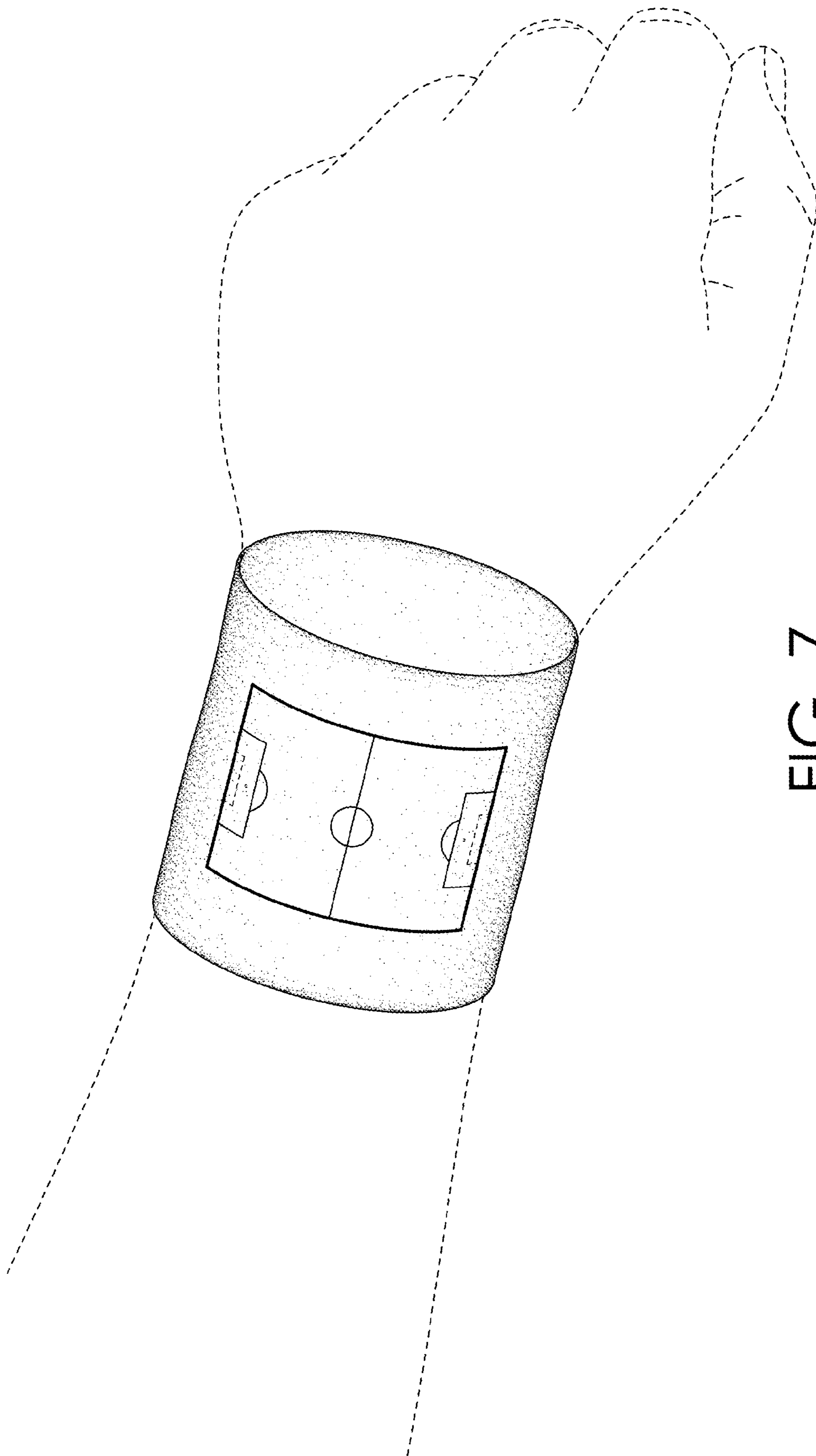

FIG. 7