



US00D973196S

(12) **United States Design Patent**
Zhu

(10) **Patent No.:** **US D973,196 S**

(45) **Date of Patent:** **** Dec. 20, 2022**

(54) **RESPIRATORY MASK**

(71) Applicant: **Pengfei Zhu**, Changde (CN)

(72) Inventor: **Pengfei Zhu**, Changde (CN)

(**) Term: **15 Years**

(21) Appl. No.: **29/745,582**

(22) Filed: **Aug. 6, 2020**

(30) **Foreign Application Priority Data**

Feb. 8, 2020 (CN) 202030071845.6

(51) **LOC (13) Cl.** **29-02**

(52) **U.S. Cl.**
USPC **D24/110.1; D29/108**

(58) **Field of Classification Search**
USPC D24/110, 110.1-110.6; D29/108
CPC . A41D 13/11; A41D 13/1107; A41D 13/1115;
A41D 13/1123; A41D 13/113; A41D
13/1138; A41D 13/1146; A41D 13/1153;
A41D 13/1161; A41D 13/1169; A41D
13/1176; A61M 16/06; A62B 18/00;
A62B 18/02; A62B 18/025; A62B 23/00
See application file for complete search history.

(56) **References Cited**

U.S. PATENT DOCUMENTS

10,945,469 B1 * 3/2021 Rosenberg A62B 18/08
10,974,084 B1 * 4/2021 Grinvald A62B 18/025
D923,775 S * 6/2021 Gilner D24/110.4
D941,989 S * 1/2022 Ward D24/110.1
D943,735 S * 2/2022 Hu D24/110.1

11,235,181 B2 * 2/2022 Daeffler A62B 18/025
D945,078 S * 3/2022 Wu D29/108
D945,599 S * 3/2022 Rosenberg D29/108
D946,832 S * 3/2022 Jiang D29/108
D951,430 S * 5/2022 Lin D24/110.1
D954,936 S * 6/2022 Gray D29/108
D956,953 S * 7/2022 Tu D29/108
D958,967 S * 7/2022 Zhu D24/110.1

* cited by examiner

Primary Examiner — Richard Kearney
Assistant Examiner — Michael Hoffman

(57) **CLAIM**

The ornamental design for a respiratory mask, as shown and described.

DESCRIPTION

FIG. 1 is a front perspective view of a respiratory mask showing my new design;
FIG. 2 is a rear perspective view thereof;
FIG. 3 is a front view thereof;
FIG. 4 is a rear view thereof;
FIG. 5 is a left side view thereof;
FIG. 6 is a right side view thereof;
FIG. 7 is a top view thereof; and
FIG. 8 is a bottom view thereof; and,
FIG. 9 is a perspective view of the respiratory mask where a detachable mask filter is separated from a mask body.
All broken line portions of the figure drawings is included to show portions of the article that form no part of the claimed design.

1 Claim, 9 Drawing Sheets

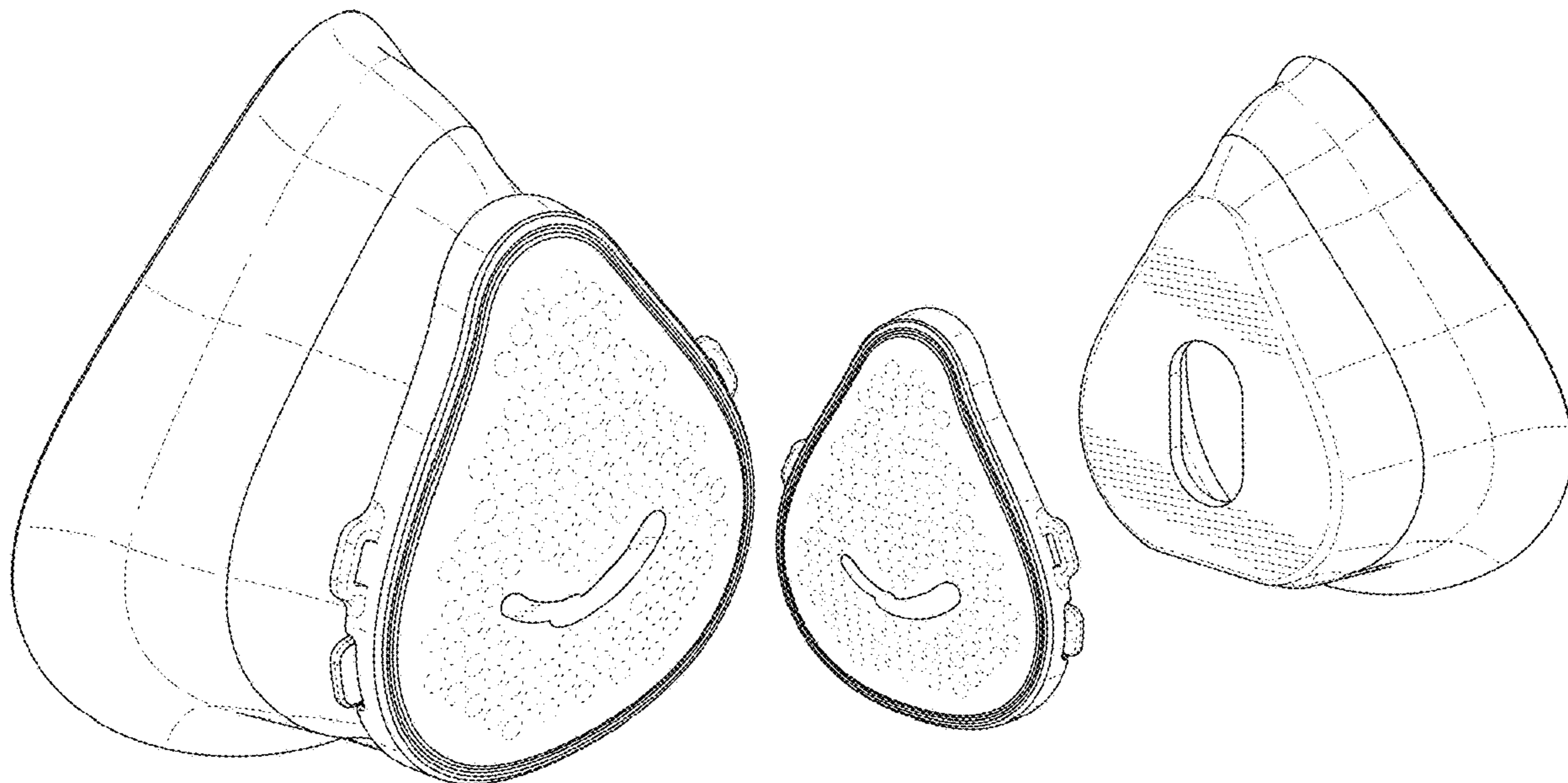

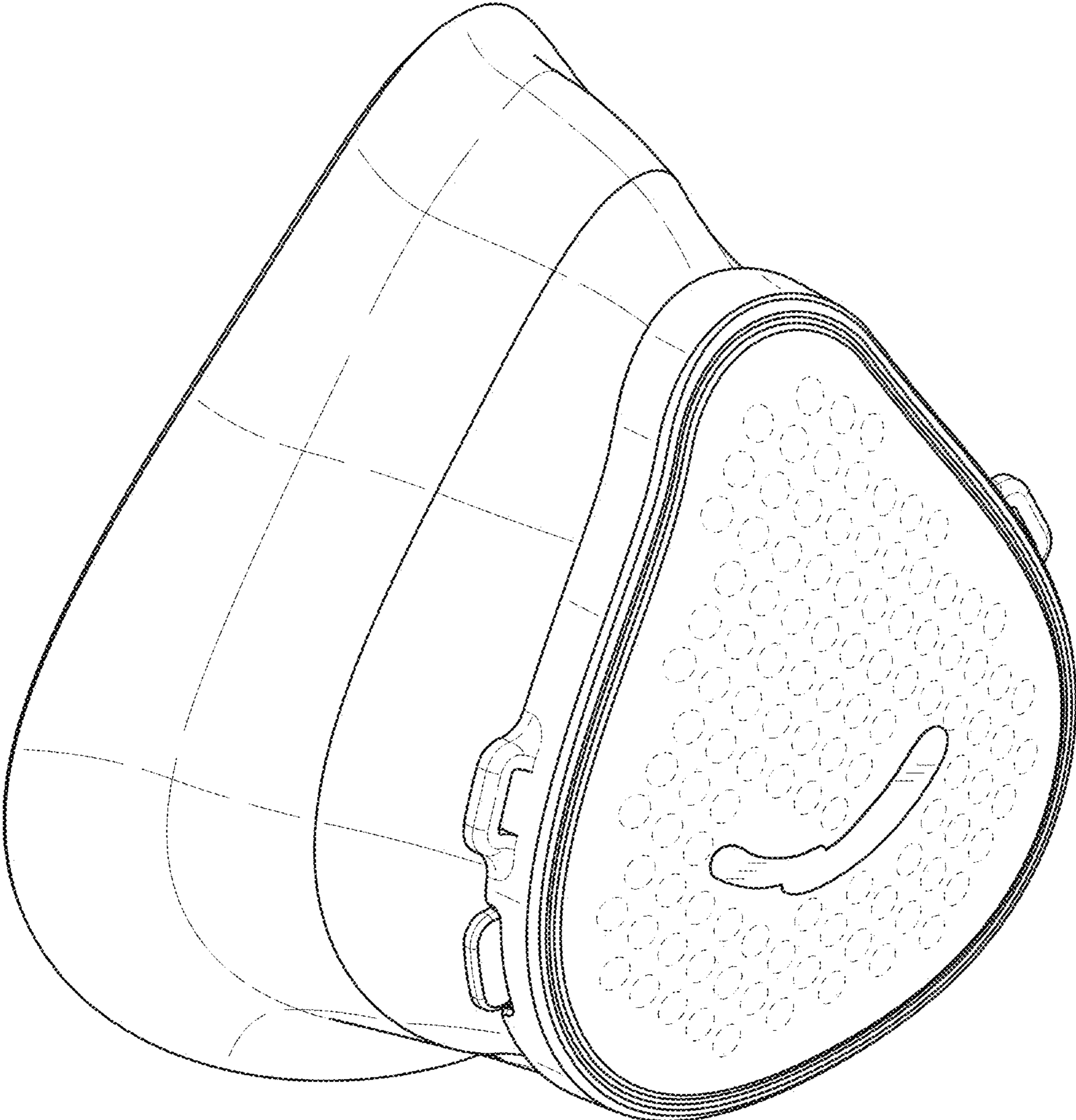

FIG. 1

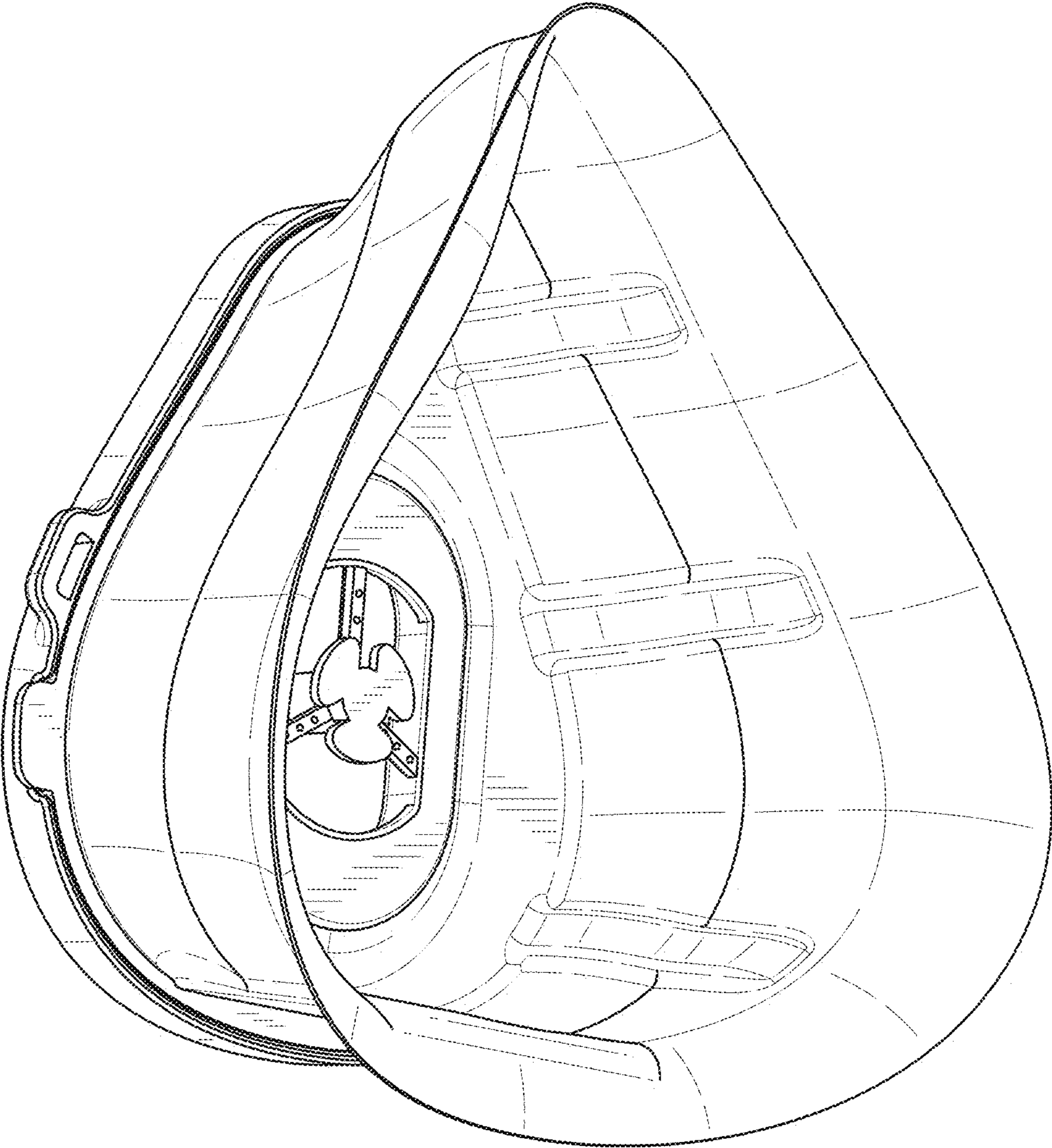

FIG. 2

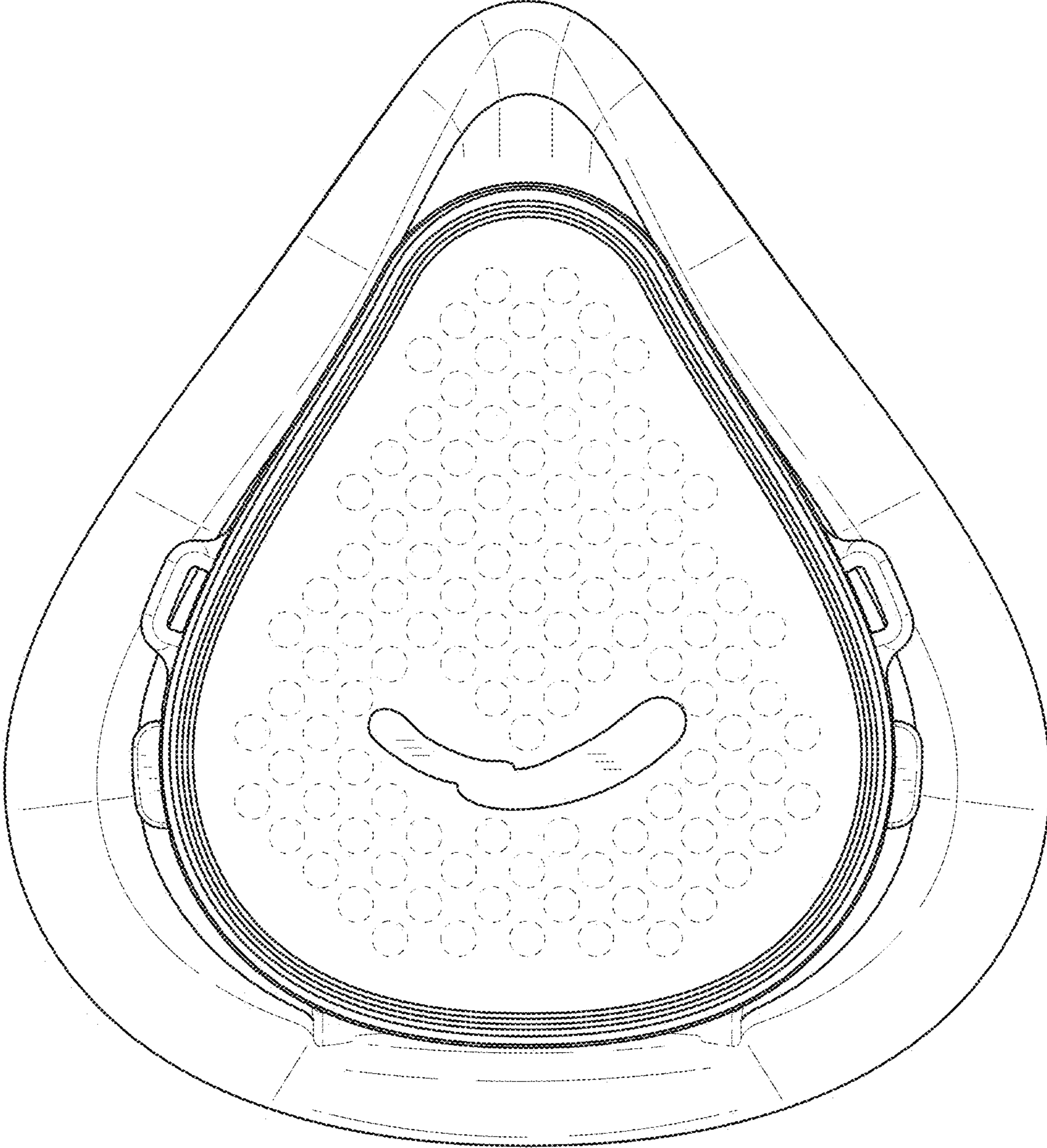

FIG. 3

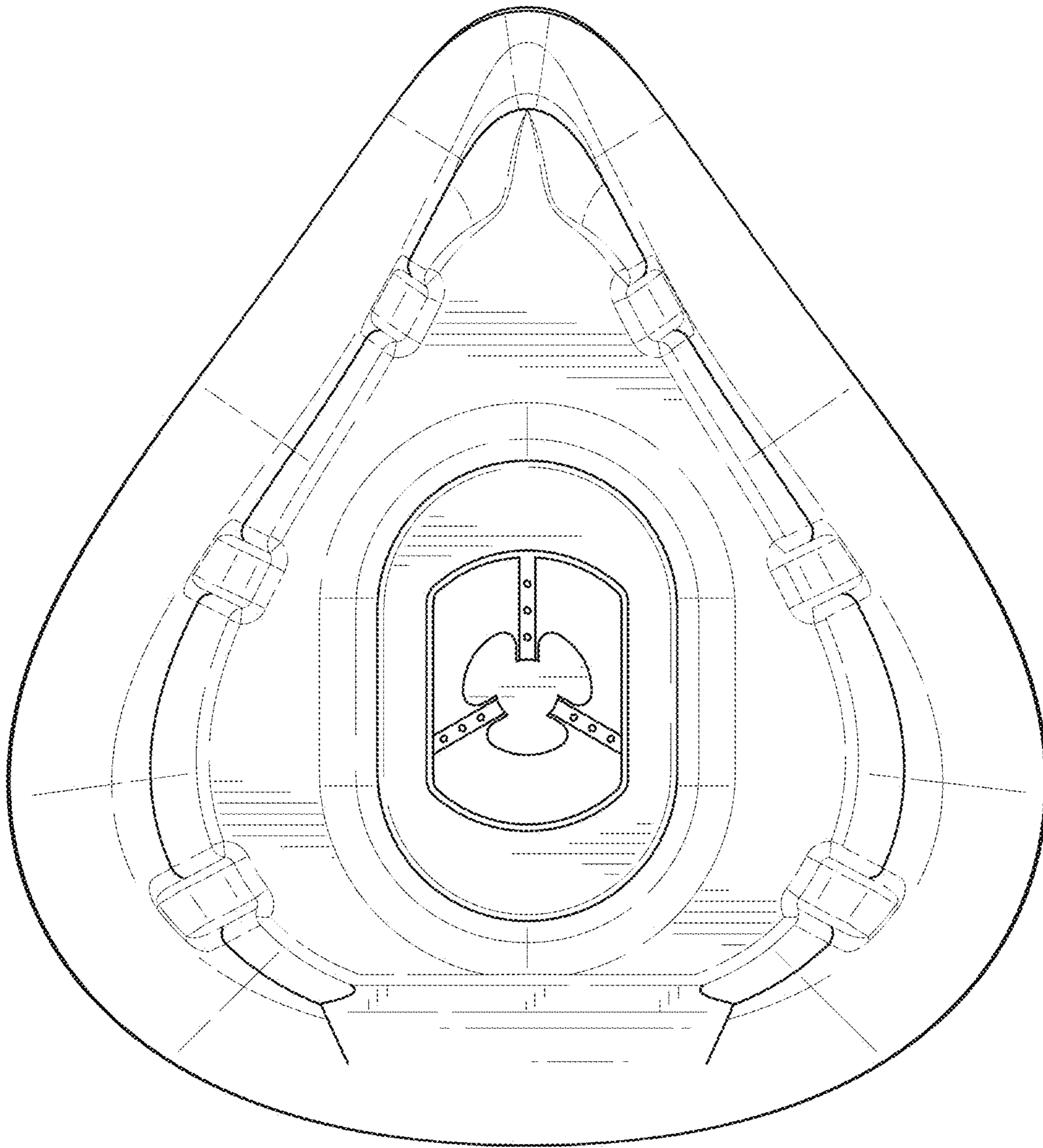

FIG. 4

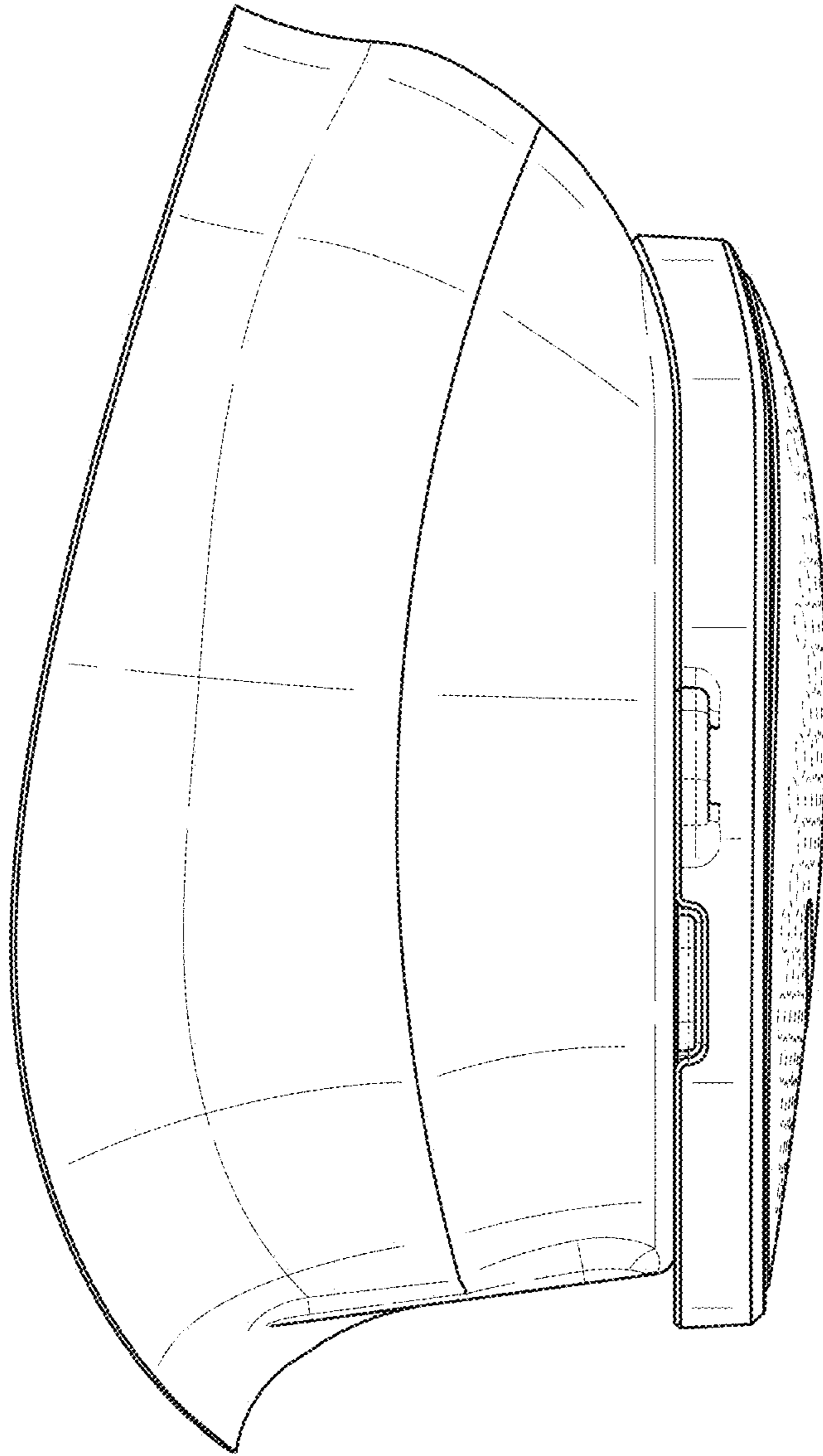

FIG. 5

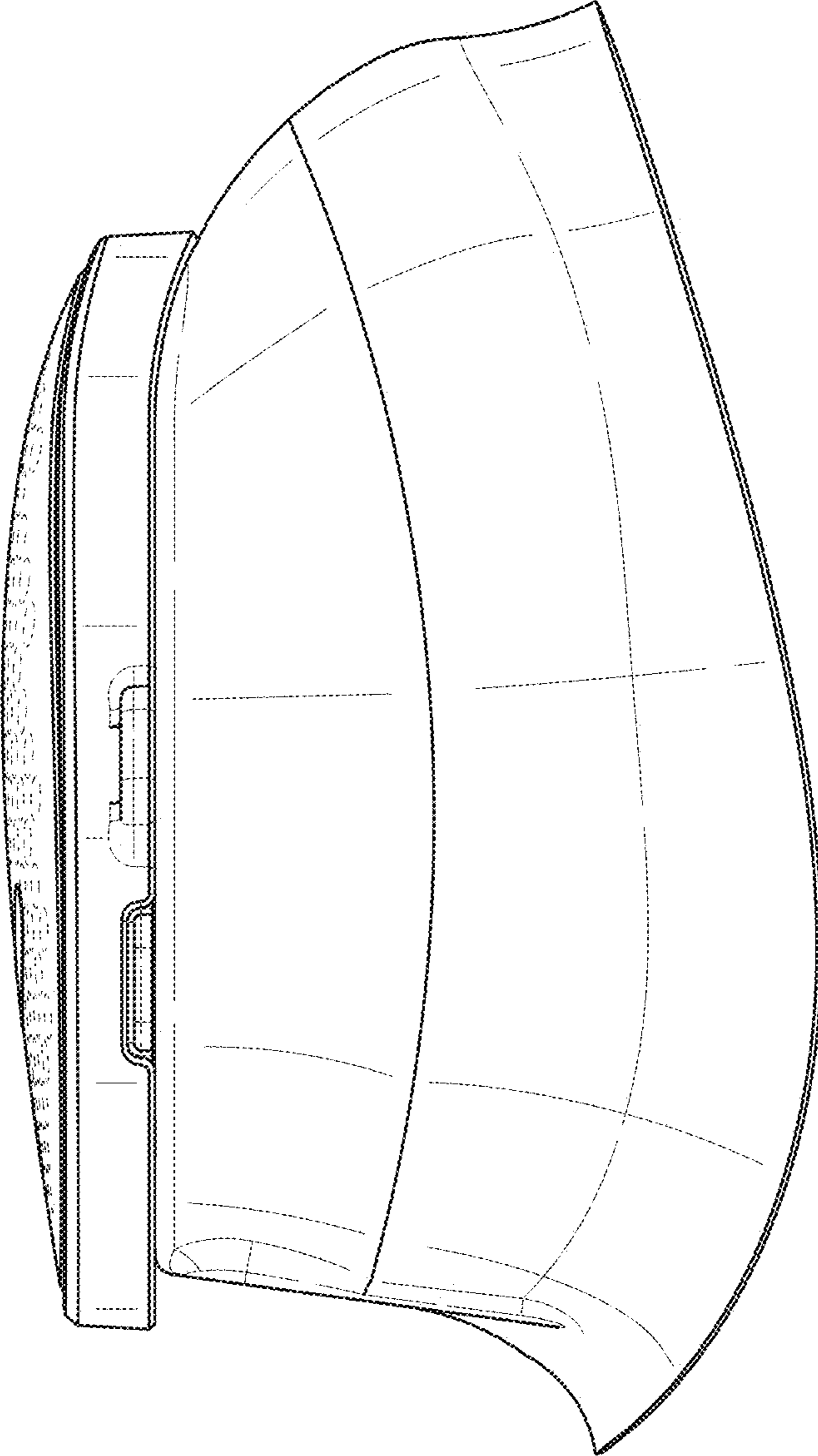

FIG. 6

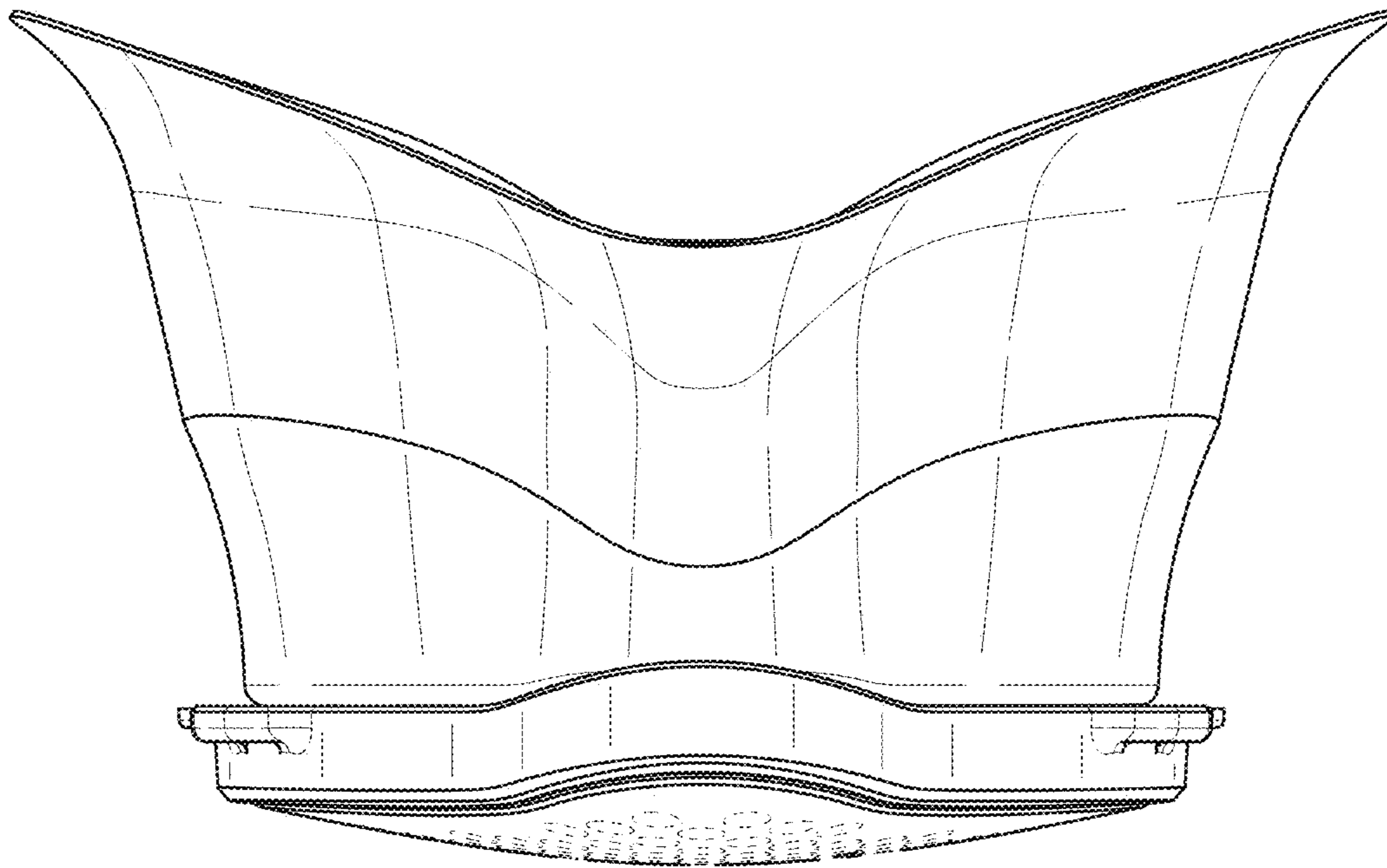

FIG. 7

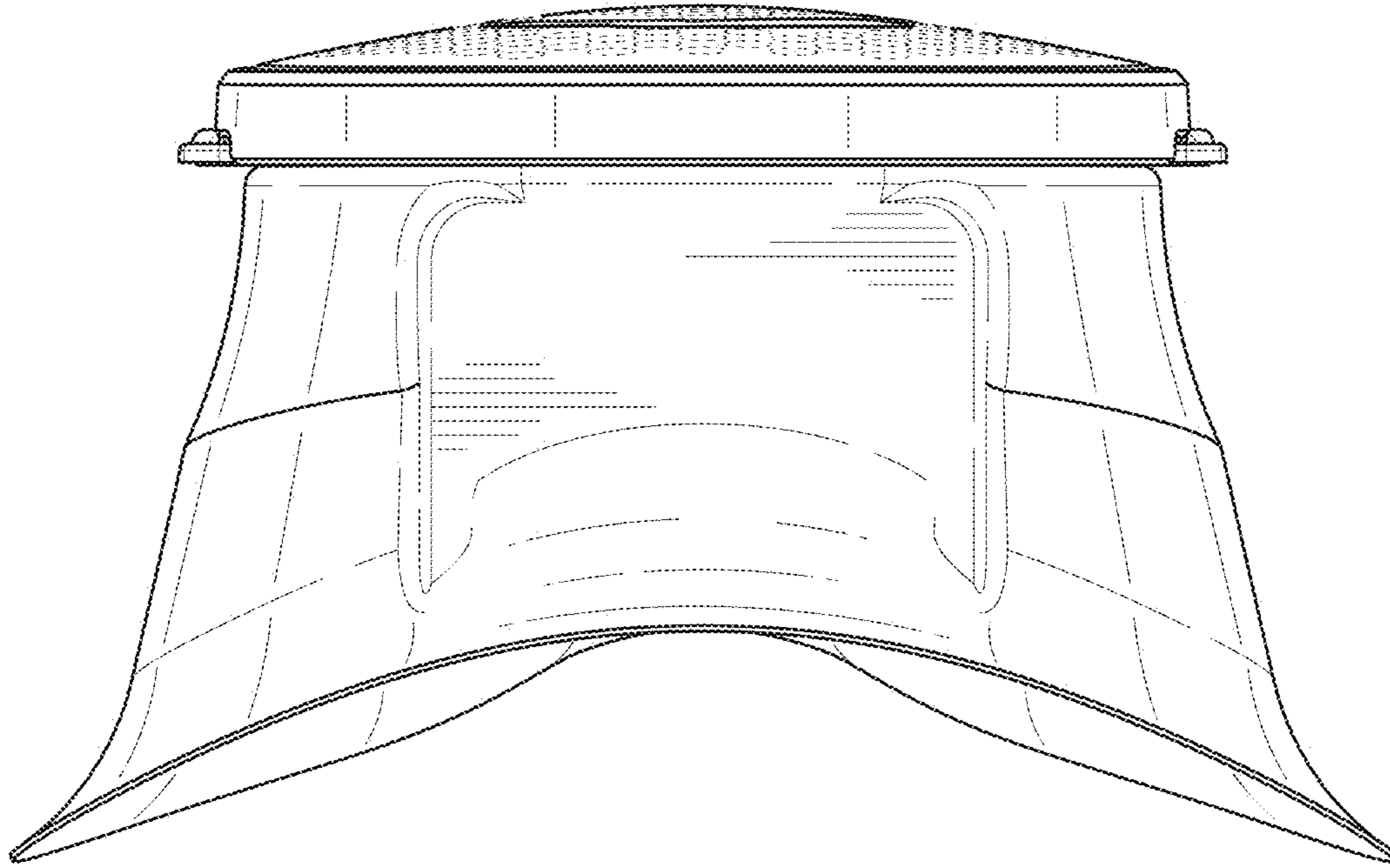

FIG. 8

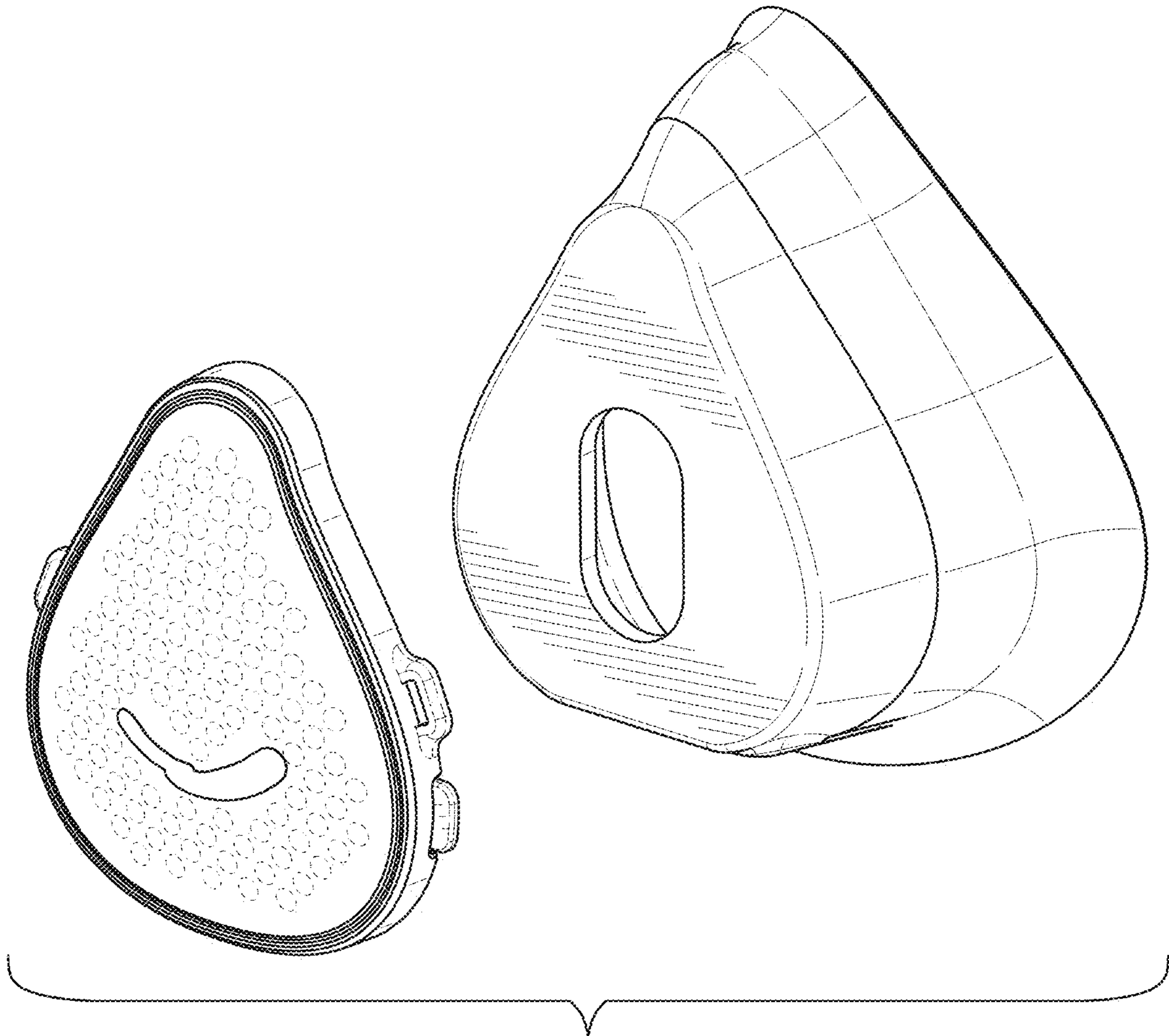

FIG. 9