



US00D973138S

(12) **United States Design Patent** (10) **Patent No.:** **US D973,138 S**
Li (45) **Date of Patent:** **** Dec. 20, 2022**

(54) **TOY PIANO**

FOREIGN PATENT DOCUMENTS

(71) Applicant: **Xi Li**, Shantou (CN)

CN 301062768 * 11/2009
CN 301091311 * 12/2009

(72) Inventor: **Xi Li**, Shantou (CN)

(Continued)

(**) Term: **15 Years**

OTHER PUBLICATIONS

(21) Appl. No.: **29/759,949**

Multi-Function Kids Drum Toy, available on walmart.com, [site visited Mar. 9, 2022], URL: <https://www.walmart.com/ip/Multi-Function-Kids-Drum-Toy-Toy-with-Piano-Keyboard-Music-Cognition-Development-Gifts-Instruments-Hand-Drum-Toy-Kids-Drum-Set-for-Kids-Baby-Green/650998256?athbdg=L1700> (Year: 2022).*

(22) Filed: **Nov. 26, 2020**

Plastic Electronic Toy, available on aliexpress.com, [site visited Mar. 9, 2022], URL: <https://www.aliexpress.com/item/32855368033.html> (Year: 2022).*

(51) **LOC (13) Cl.** **21-01**

(52) **U.S. Cl.**

USPC **D21/409**

(58) **Field of Classification Search**

USPC D21/398, 468, 469, 470, 474, 475, 476,
D21/405, 406, 407, 409, 410, 411;
D19/59, 60, 62; D14/341; D17/1, 2, 24,
D17/99

CPC A63F 9/06; A63F 9/08; A63H 5/00; G09B
1/00; G09B 1/02; G09B 1/06; G09B
1/14; G09B 1/18; G09B 11/00; G09B
15/00; G09B 15/001; G09B 15/002;
G09B 15/003; G10C 1/00; G10H
2230/045; G10H 2230/055; G10H
2230/065

See application file for complete search history.

(Continued)

Primary Examiner — Dana K Weiland

Assistant Examiner — Emily Anna Saunders

(74) *Attorney, Agent, or Firm* — Rumit R. Kanakia

(56) **References Cited**

U.S. PATENT DOCUMENTS

D255,370 S * 6/1980 Hayama D17/1
D315,178 S * 3/1991 Takahashi D21/409
D318,305 S * 7/1991 Takahashi D21/410
D322,640 S * 12/1991 Billings D17/1
D342,274 S * 12/1993 Ohki D17/1
D348,483 S * 7/1994 Chow D21/324
D355,924 S * 2/1995 Slater D17/1
D359,521 S * 6/1995 Kino D21/410
D361,798 S * 8/1995 Kino D21/409
D362,469 S * 9/1995 Kino D21/409
D387,090 S * 12/1997 Mah D14/395
D389,876 S * 1/1998 Leung D17/1
5,841,051 A * 11/1998 Segan G09B 15/003
84/478
D436,142 S * 1/2001 Araki D21/475

(Continued)

DESCRIPTION

FIG. 1 is a first perspective view of a toy piano showing my new design;

FIG. 2 is a second perspective view thereof;

FIG. 3 is a front view thereof;

FIG. 4 is a back view thereof;

FIG. 5 is a left side view thereof;

FIG. 6 is a right side view thereof;

FIG. 7 is atop view thereof; and,

FIG. 8 is a bottom view thereof.

The broken lines shown in the drawings depict portions of the toy piano in which the design is embodied that form no part of the claimed design.

1 Claim, 8 Drawing Sheets

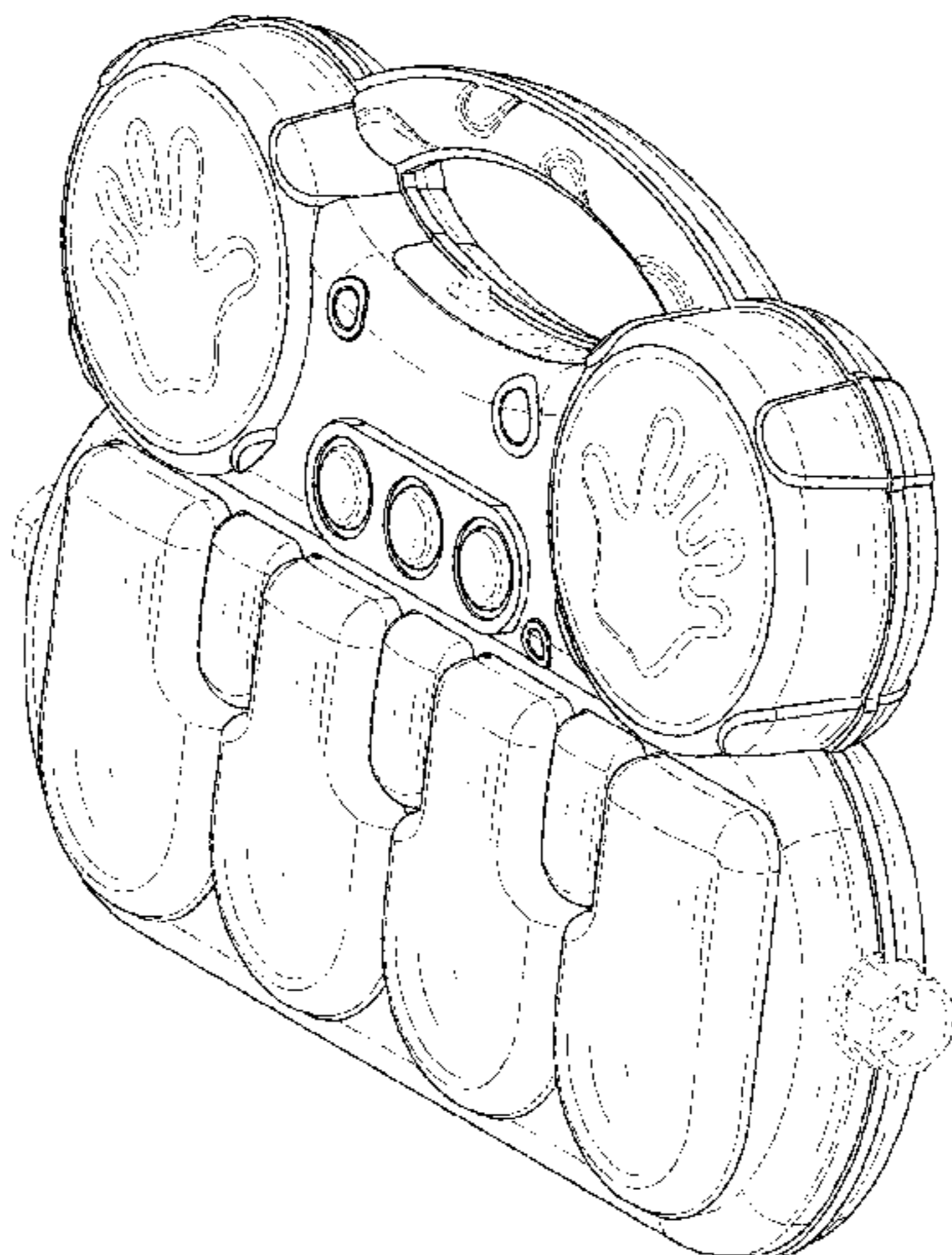

(56)

References Cited

U.S. PATENT DOCUMENTS

6,274,800	B1 *	8/2001	Gardner	G10H 1/32 84/743
D451,970	S *	12/2001	Chan	D21/475
D487,118	S *	2/2004	Elias	D21/409
D488,517	S *	4/2004	Cheng	D21/516
D551,230	S *	9/2007	Lau	D14/401
8,008,563	B1 *	8/2011	Hastings	G09B 15/08 84/479 A
D837,283	S *	1/2019	Tsai	D17/2
D919,711	S *	5/2021	Zhang	D21/409

FOREIGN PATENT DOCUMENTS

CN	302416137	*	4/2013
CN	302782026	*	4/2014
CN	303429153	*	11/2015
CN	305173872	*	5/2019
CN	305776107	*	5/2020
CN	305913976	*	7/2020
CN	306329909	*	2/2021
CN	306580883	*	6/2021
EM	006373320-0002	*	4/2019
FR	941117-004	*	2/1994
JP	D1247296	*	8/2005

OTHER PUBLICATIONS

Fisher Price Laugh and Learn Puppy Piano, available on amazon.com, oldest customer review Jan. 30, 2016, [site visited Mar. 9, 2022], URL: [https://www.amazon.com/Fisher-Price-Laugh-Learn-Puppys-Piano/dp/B014KEEF0M/\(Year: 2016\).](https://www.amazon.com/Fisher-Price-Laugh-Learn-Puppys-Piano/dp/B014KEEF0M/(Year: 2016).)*

Little Tikes Tap and Tune Piano, available on amazon.com, date first available Dec. 16, 2018, [site visited Mar. 9, 2022], URL: [https://www.amazon.com/Little-Tikes-Tap-Tune-Piano/dp/B01M1CH242/\(Year: 2018\).](https://www.amazon.com/Little-Tikes-Tap-Tune-Piano/dp/B01M1CH242/(Year: 2018).)*

Litaonner Toy Piano Baby Drum Musical, available on amazon.com, oldest customer review Feb. 22, 2021, [site visited Mar. 9, 2022], URL: [https://www.amazon.com/Litaonner-Musical-Instrument-Keyboard-Birthday/dp/B093Q41SJW/\(Year: 2021\).](https://www.amazon.com/Litaonner-Musical-Instrument-Keyboard-Birthday/dp/B093Q41SJW/(Year: 2021).)*

Hitish Toddler Musical Piano, available on amazon.com, date first available Apr. 26, 2021, [site visited Mar. 9, 2022], URL: [https://www.amazon.com/dp/B093H69SD4/\(Year: 2021\).](https://www.amazon.com/dp/B093H69SD4/(Year: 2021).)*

HOMCENT Musical Toys for Toddlers, available on amazon.com, [site visited Mar. 9, 2022], URL: [https://www.amazon.com/dp/B09JFJJP4Y/\(Year: 2022\).](https://www.amazon.com/dp/B09JFJJP4Y/(Year: 2022).)*

KingsDragon Baby Musical Keyboard Piano, available on amazon.com, oldest customer review Jul. 28, 2019 [site visited Mar. 9, 2022], URL: [https://www.amazon.com/KINGSDRAGON-Musical-Keyboard-Educational-Development/dp/B07RT59VGV/\(Year: 2019\).](https://www.amazon.com/KINGSDRAGON-Musical-Keyboard-Educational-Development/dp/B07RT59VGV/(Year: 2019).)*

* cited by examiner

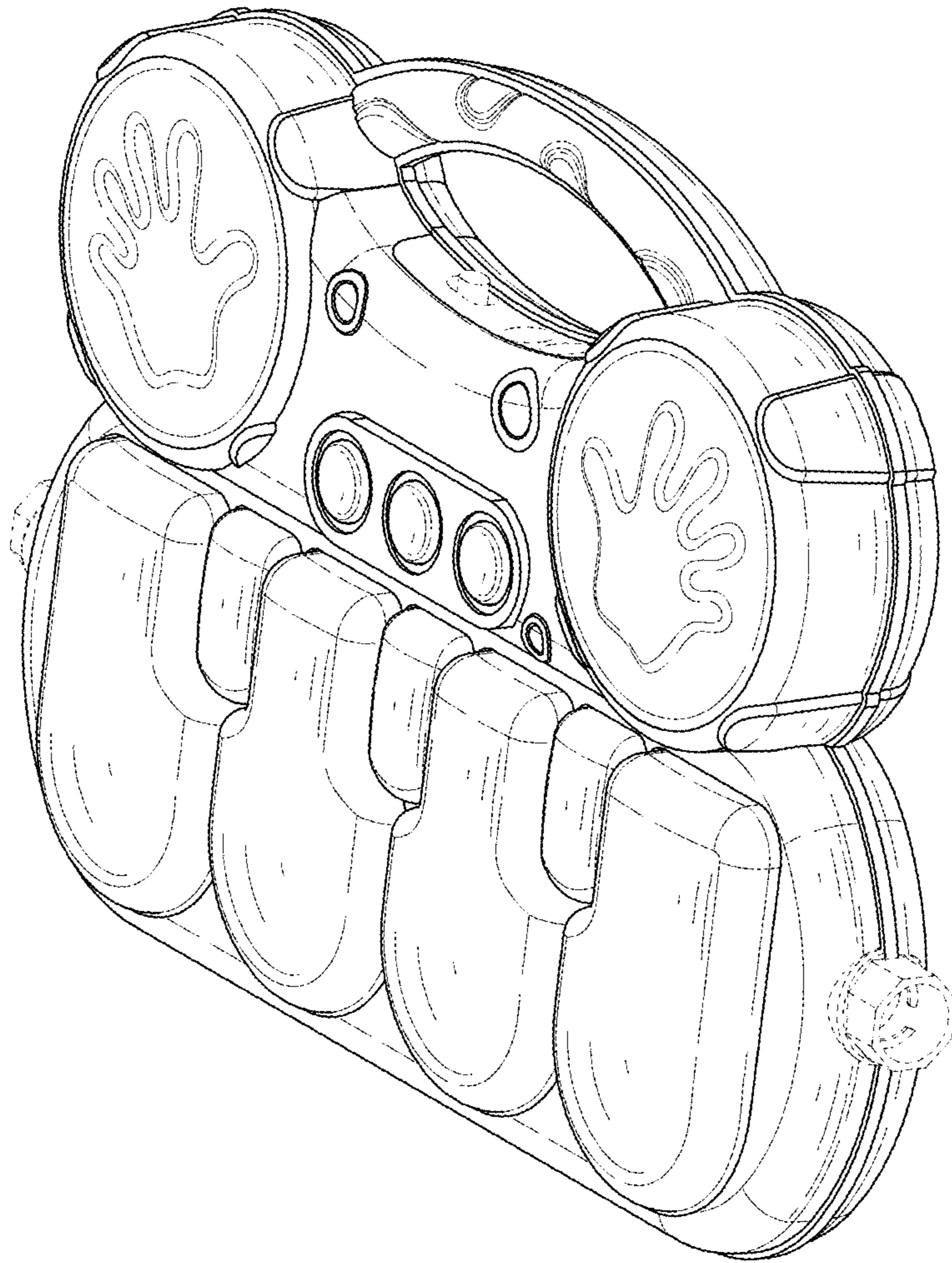

FIG. 1

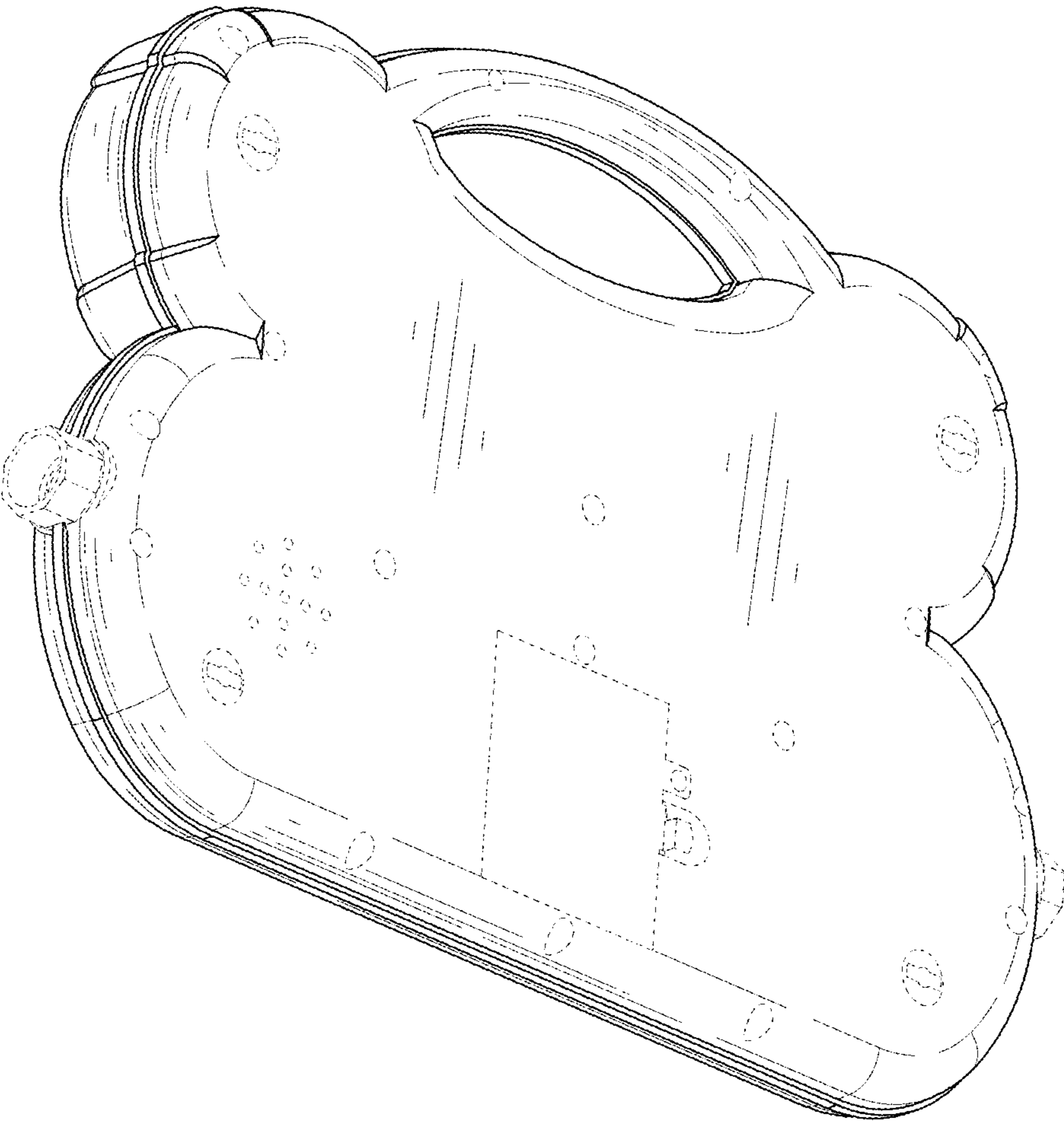

FIG. 2

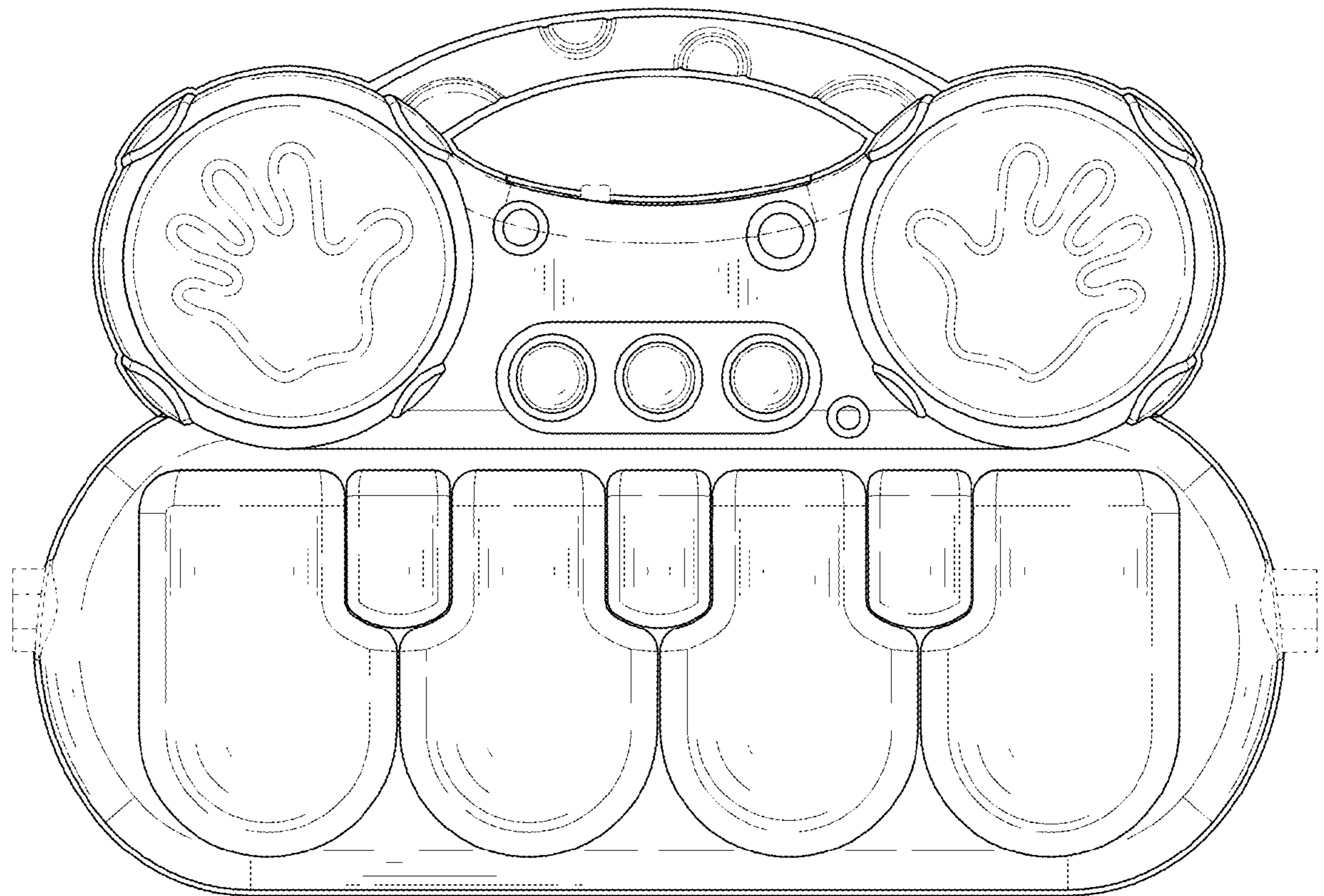

FIG. 3

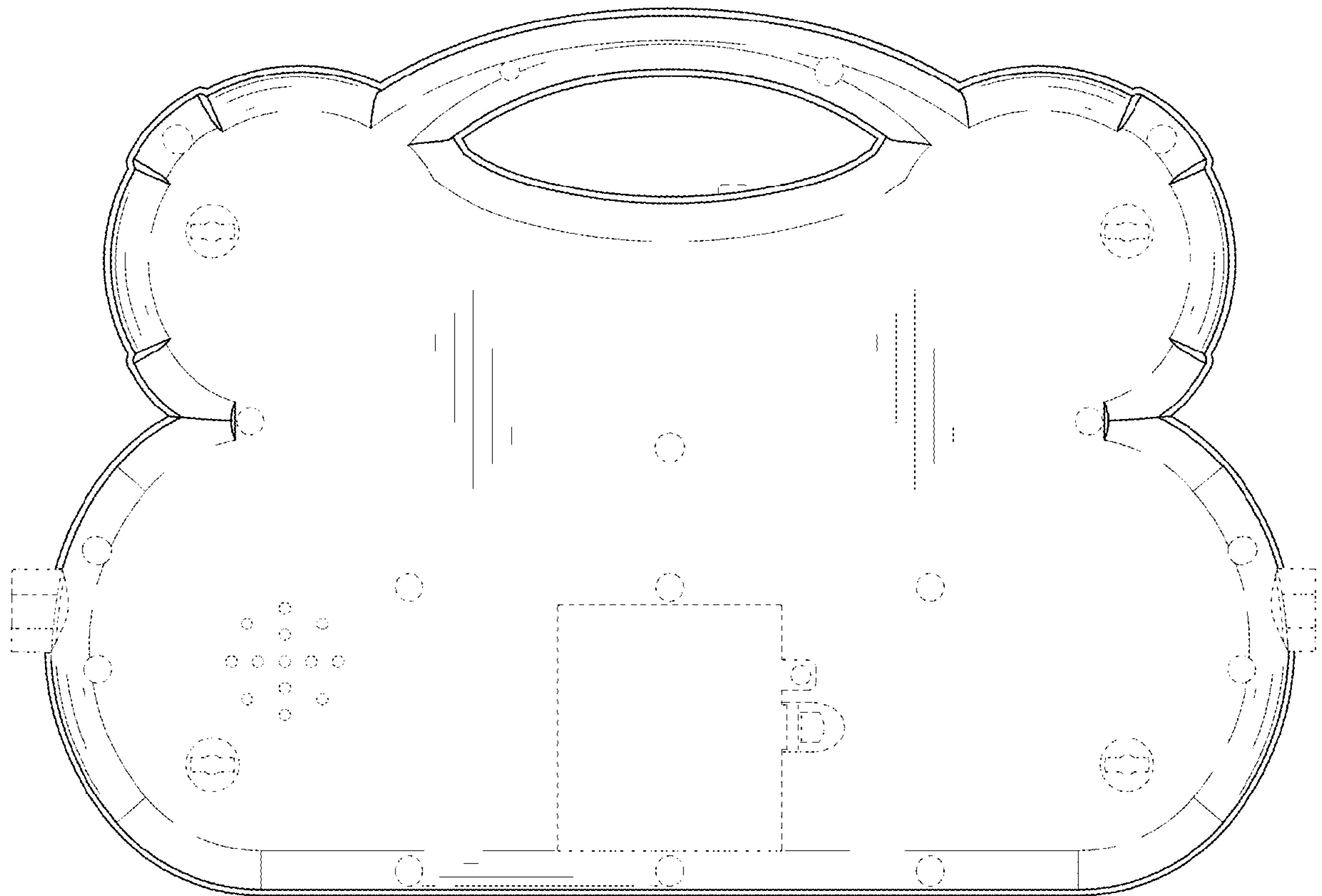

FIG. 4

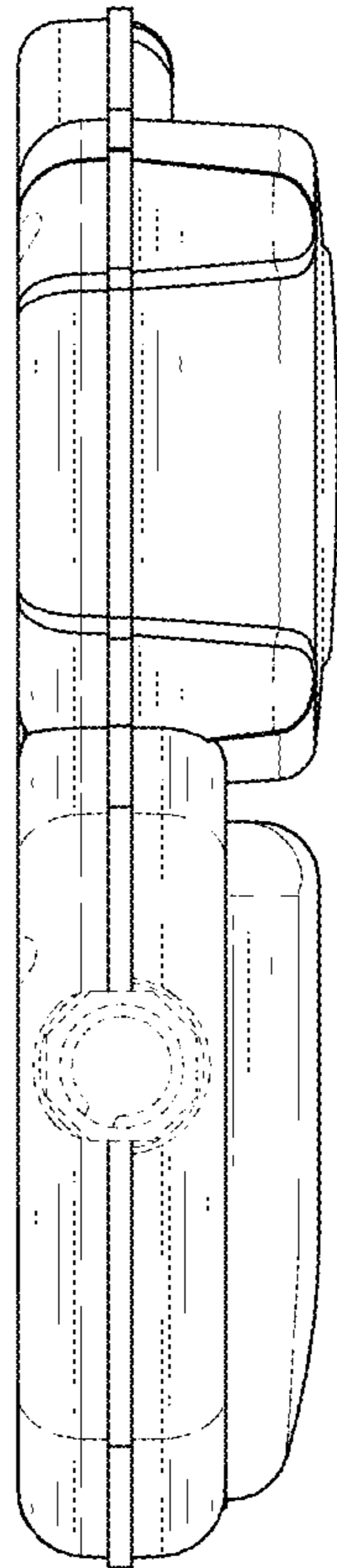

FIG. 5

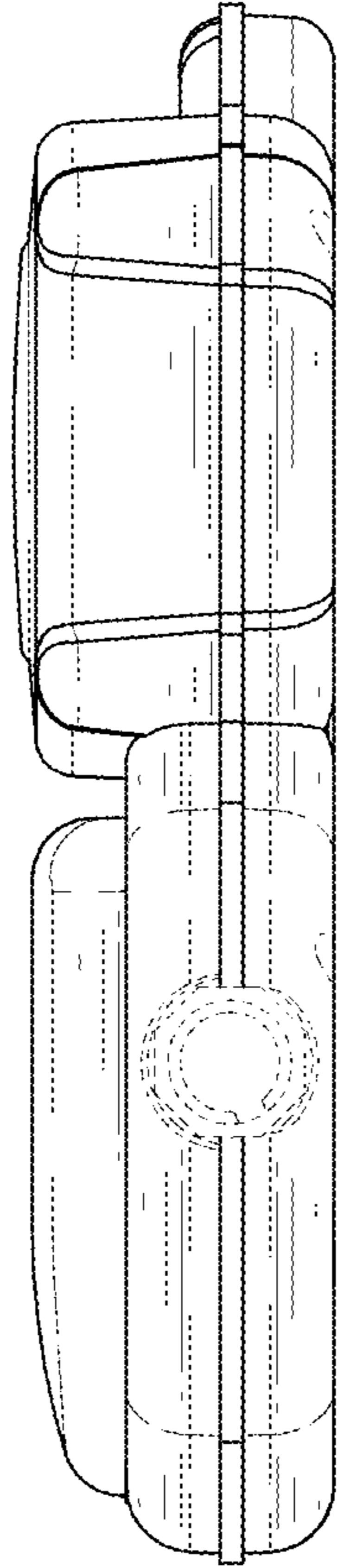

FIG. 6

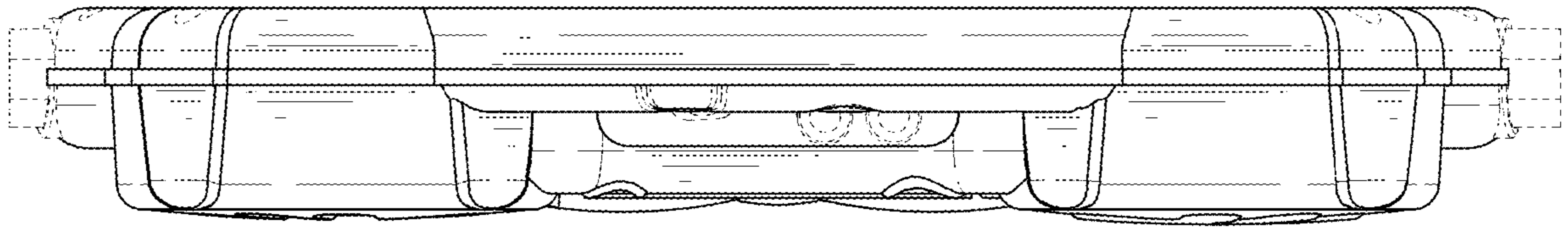

FIG. 7

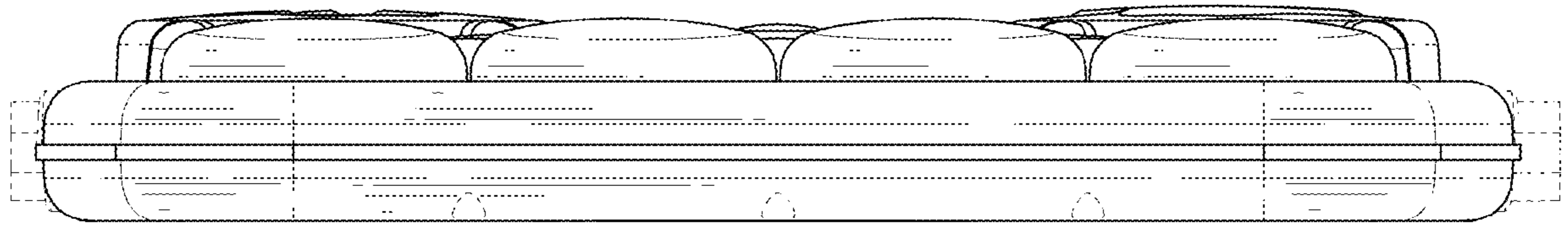

FIG. 8