



US00D973018S

(12) **United States Design Patent**  
**Yuan**

(10) **Patent No.:** **US D973,018 S**

(45) **Date of Patent:** **\*\* Dec. 20, 2022**

(54) **PORTABLE POWER STATION**

(71) Applicant: **SHENZHEN TAOTAOMAI ELECTRONIC COMMERCE CO., LTD.**, Shenzhen (CN)

(72) Inventor: **Fanghao Yuan**, Shenzhen (CN)

(73) Assignee: **SHENZHEN TAOTAOMAI ELECTRONIC COMMERCE CO., LTD.**, Shenzhen (CN)

(\*\*) Term: **15 Years**

(21) Appl. No.: **29/826,854**

(22) Filed: **Feb. 16, 2022**

(51) **LOC (13) Cl.** ..... **13-02**

(52) **U.S. Cl.**  
USPC ..... **D13/107; D13/109**

(58) **Field of Classification Search**  
USPC ..... D13/103, 104, 106, 107, 108, 109, 110, D13/112, 116, 118, 119; D14/432, 433, D14/434  
CPC ..... H02J 7/0027; H02J 15/00; F02N 11/12  
See application file for complete search history.

(56) **References Cited**

**U.S. PATENT DOCUMENTS**

D868,686 S	*	12/2019	Zhong	.....	D13/106
D870,042 S	*	12/2019	Chen	.....	D13/109
D902,857 S	*	11/2020	Jia	.....	D13/110
D911,273 S	*	2/2021	Sun	.....	D13/103
D911,935 S	*	3/2021	Alexander	.....	D13/107
D931,800 S	*	9/2021	Fang	.....	D13/103
D931,804 S		9/2021	Xiong		
D932,431 S		10/2021	Liu		

(Continued)

**OTHER PUBLICATIONS**

“Progeny Portable Power Station”. Found online May 19, 2021 at amazon.com. Reference dated Mar. 26, 2018. Retrieved from https://

www.amazon.com/dp/B08F7XNWW4/ref=sspa\_dk\_detail\_6 (Year: 2018).\*

(Continued)

*Primary Examiner* — Kendra Leslie Hamilton

*Assistant Examiner* — Amanda Christensen

(57) **CLAIM**

The ornamental design for a portable power station, as shown and described.

**DESCRIPTION**

FIG. 1 is a perspective view of a first embodiment of a portable power station showing my new design; FIG. 2 is another perspective view thereof; FIG. 3 is a front elevational view thereof; FIG. 4 is a rear elevational view thereof; FIG. 5 is a left side elevational view thereof; FIG. 6 is a right side elevational view thereof; FIG. 7 is a top plan view thereof; FIG. 8 is a bottom plan view thereof; FIG. 9 is a perspective view of the portable power station where the portable power station is in a configuration of use; FIG. 10 is a perspective view of a second embodiment of the portable power station; FIG. 11 is another perspective view thereof; FIG. 12 is a front elevational view thereof; FIG. 13 is a rear elevational view thereof; FIG. 14 is a left side elevational view thereof; FIG. 15 is a right side elevational view thereof; FIG. 16 is a top plan view thereof; FIG. 17 is a bottom plan view thereof; and, FIG. 18 is a perspective view of the portable power station where the portable power station is in a configuration of use. The broken lines in the drawings depict portions of the portable power station that form no part of the claimed design.

**1 Claim, 18 Drawing Sheets**

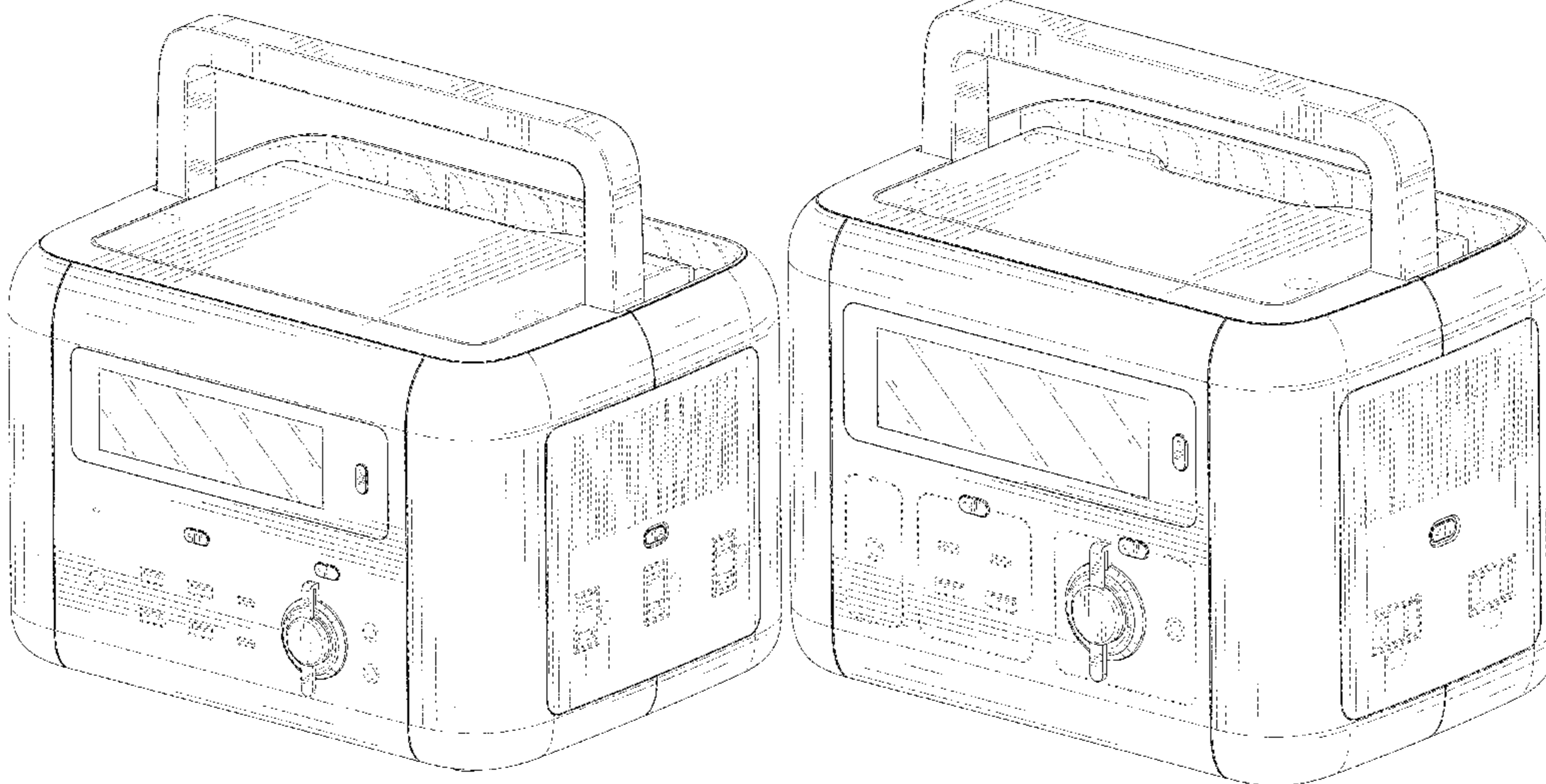

(56)

**References Cited**

U.S. PATENT DOCUMENTS

D937,207 S \* 11/2021 Zhen ..... D13/108  
D940,068 S \* 1/2022 Mao ..... D13/103  
D942,932 S \* 2/2022 Yin ..... D13/107  
D950,490 S \* 5/2022 Yu ..... D13/110  
2011/0197882 A1 \* 8/2011 Truschel ..... A61M 16/0057  
429/99  
2019/0013686 A1 \* 1/2019 Ma ..... G06F 3/01  
2022/0181892 A1 \* 6/2022 Tian ..... H02J 7/0048

OTHER PUBLICATIONS

“Baldr Portable Power Station”. Found online May 19, 2021 at amazon.com. Reference dated Jan. 17, 2020. Retrieved from [https://www.amazon.com/BALDR-Portable-Generators-Flashlight-Emergency/dp/B07YWWVRWD/ref=psdc\\_348967011\\_t5\\_B08TM3CMC1?th=1](https://www.amazon.com/BALDR-Portable-Generators-Flashlight-Emergency/dp/B07YWWVRWD/ref=psdc_348967011_t5_B08TM3CMC1?th=1). (Year: 2020).\*

“Shenzhen Poweroak Portable Generator”. Found online Aug. 24, 2021 at g-mark.org. Reference dated Jun. 1, 2019. Retrieved from <https://www.g-mark.org/award/describe/48551?locale=en>. (Year: 2019).\*

\* cited by examiner

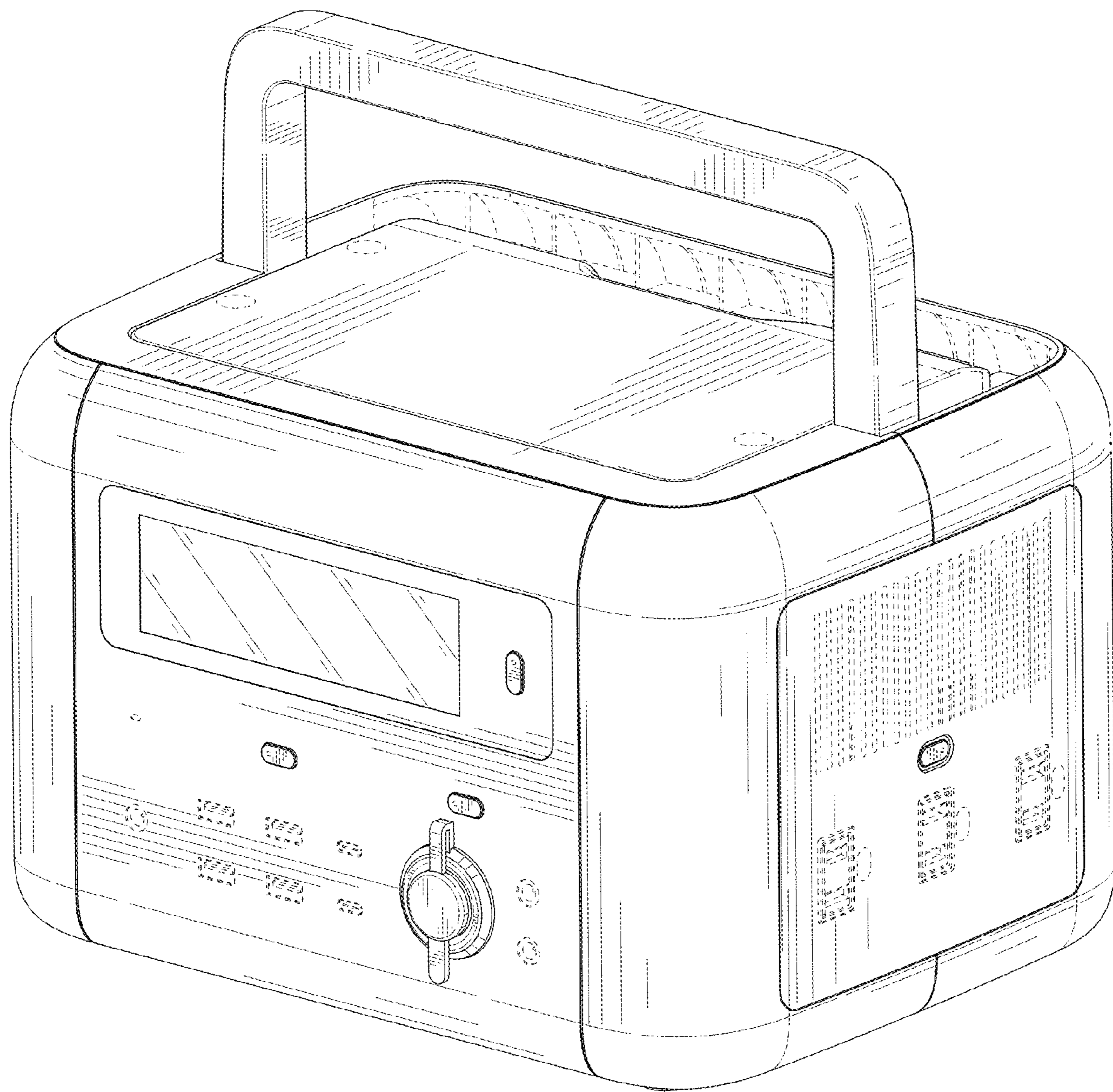

FIG. 1

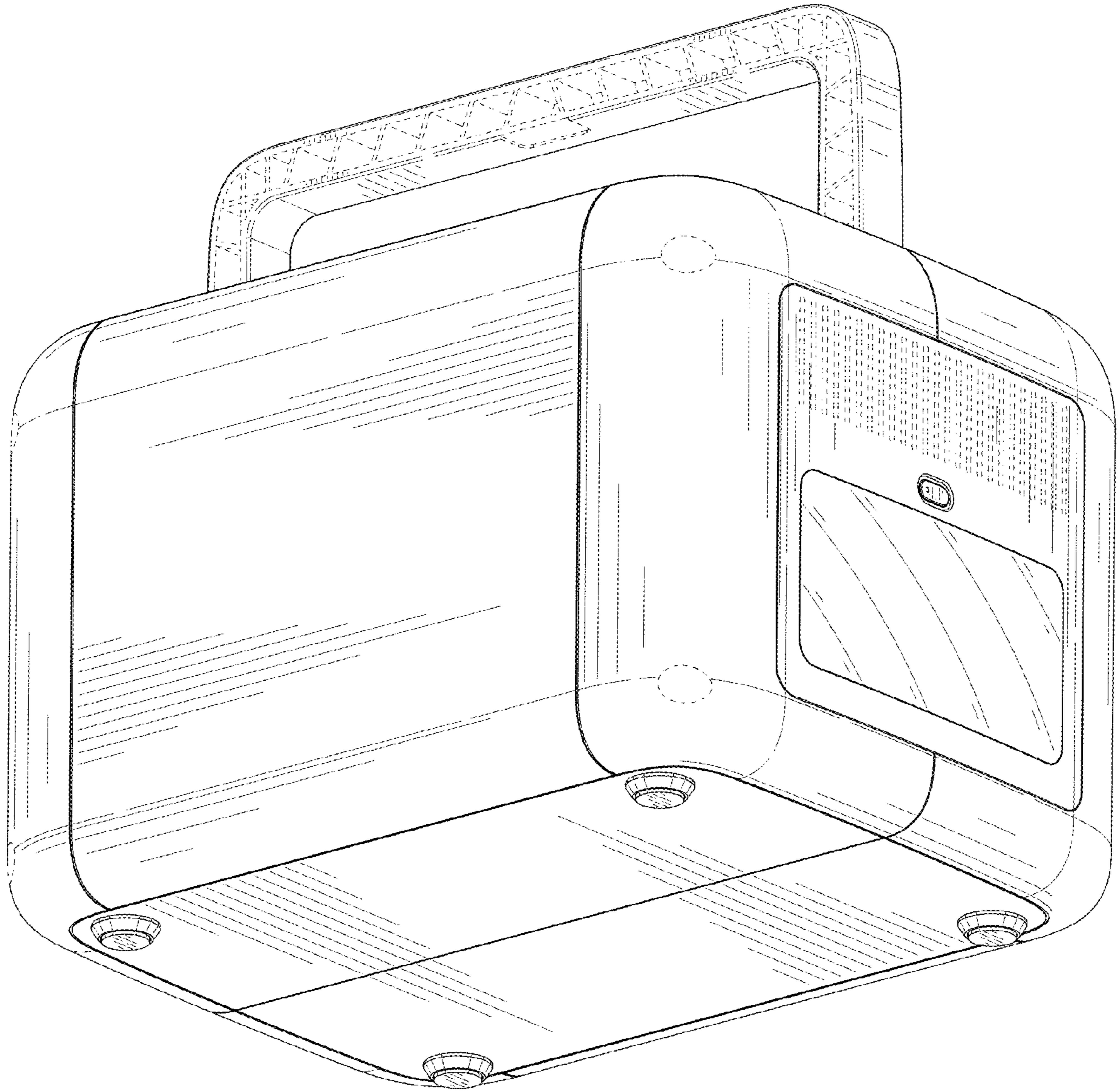

FIG. 2

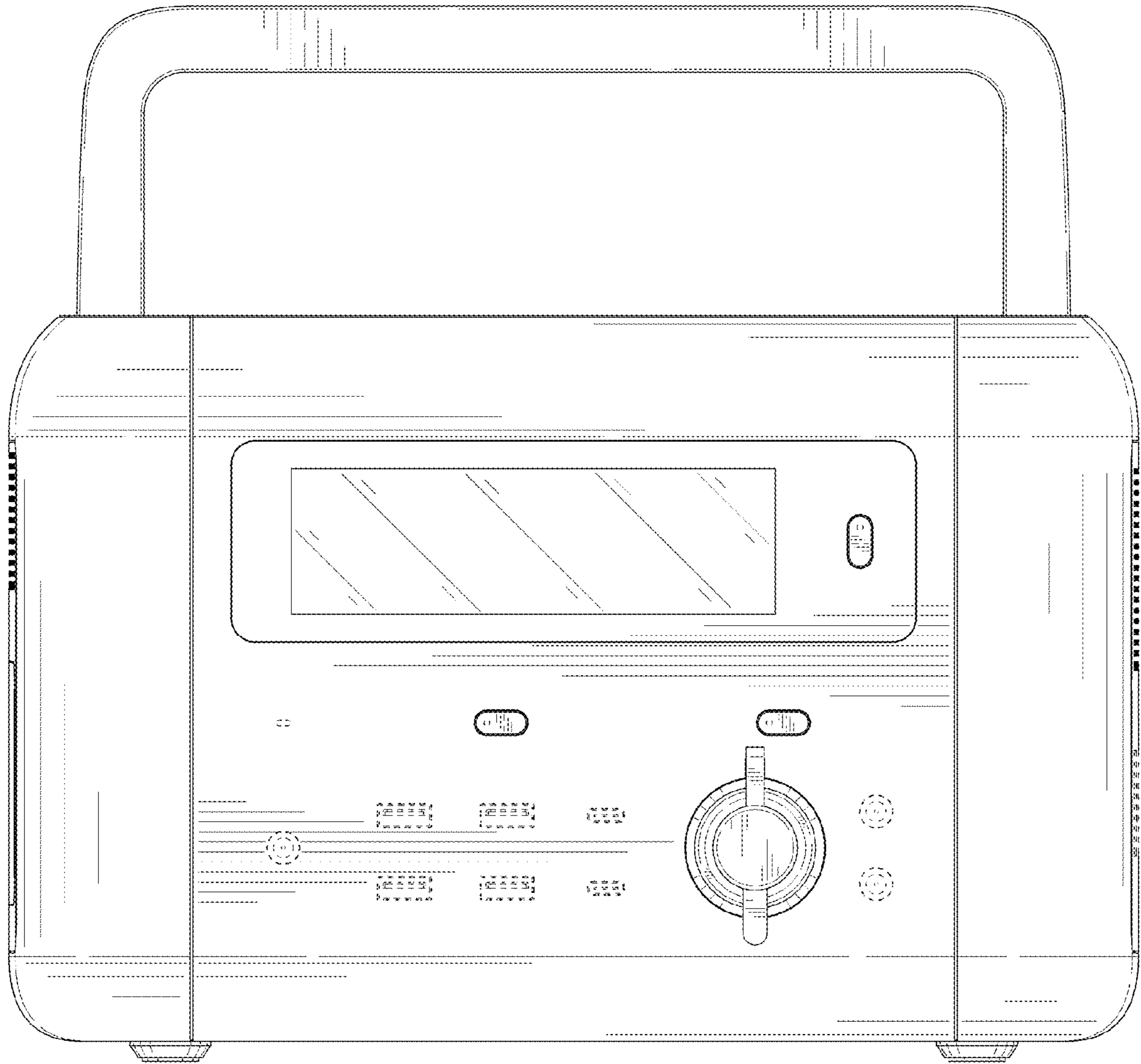

FIG. 3

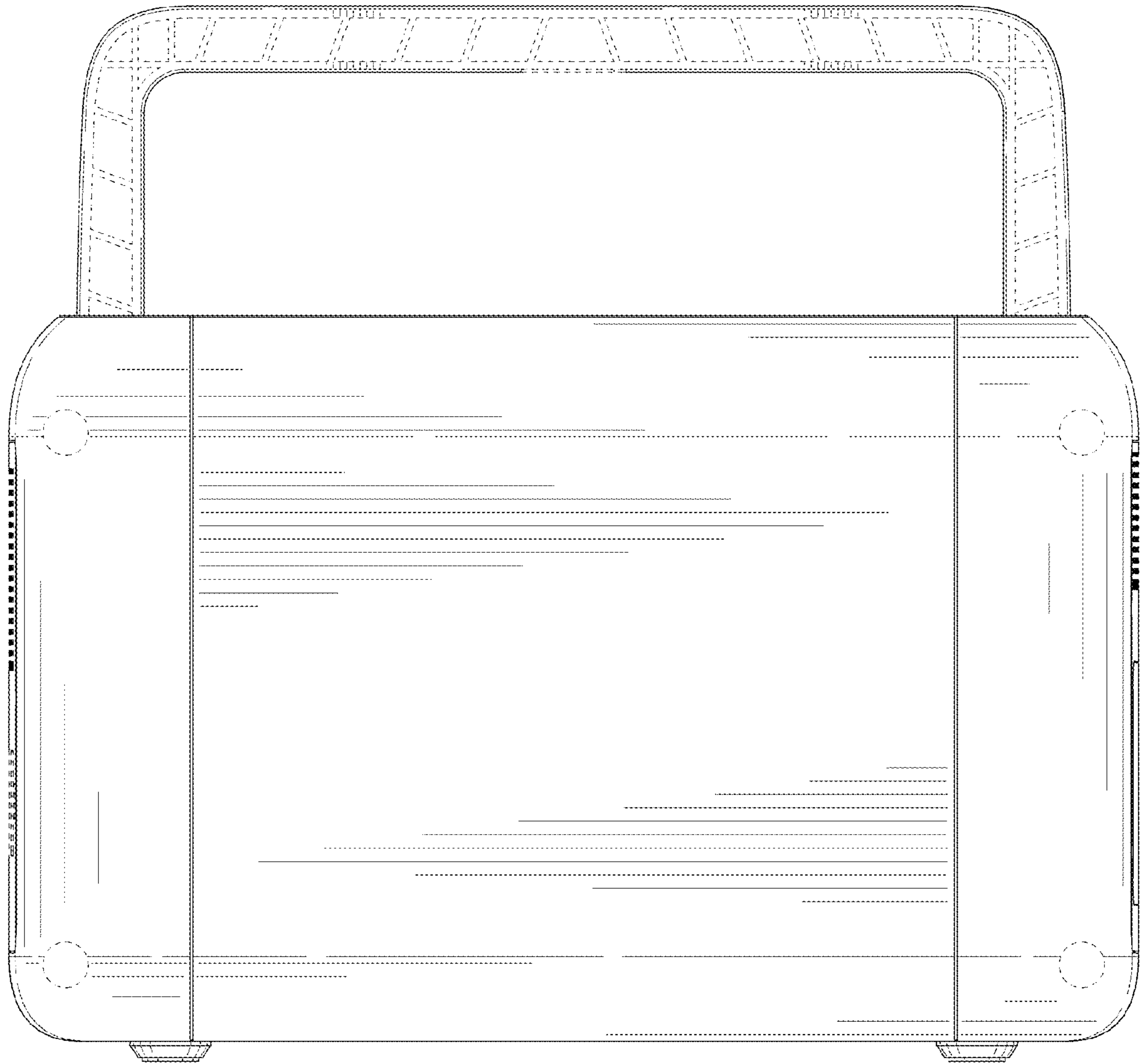

FIG. 4

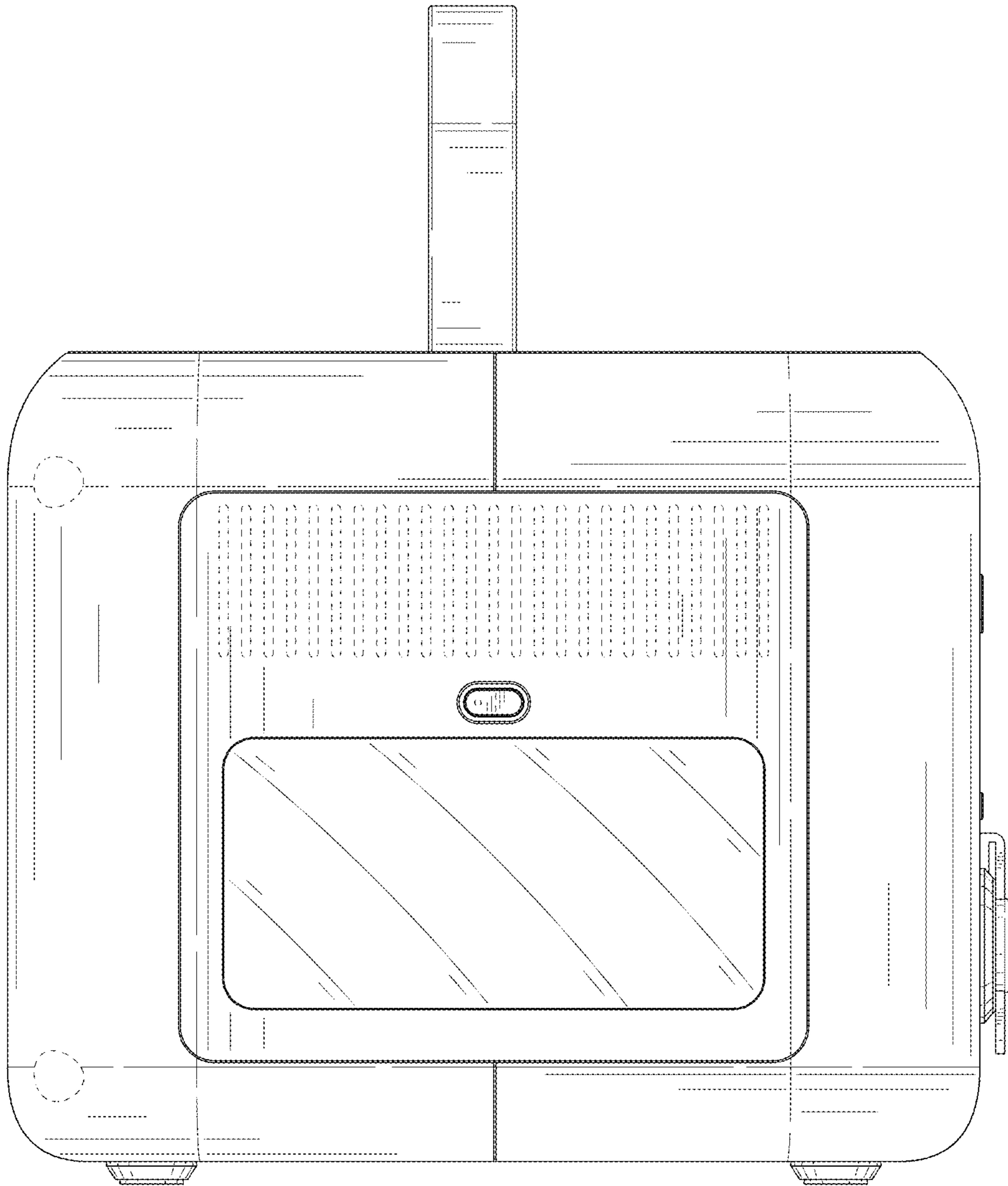

FIG. 5

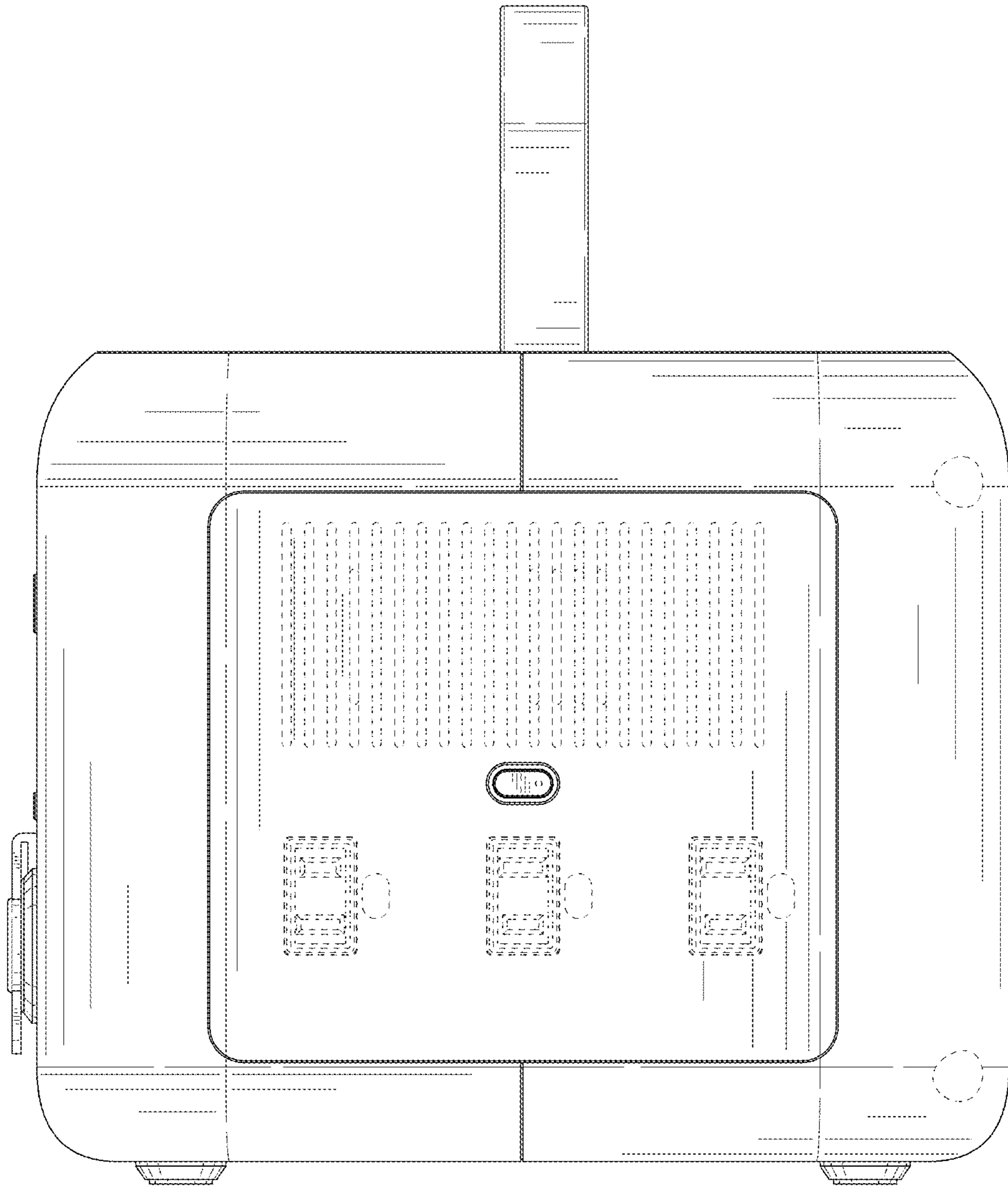

FIG. 6



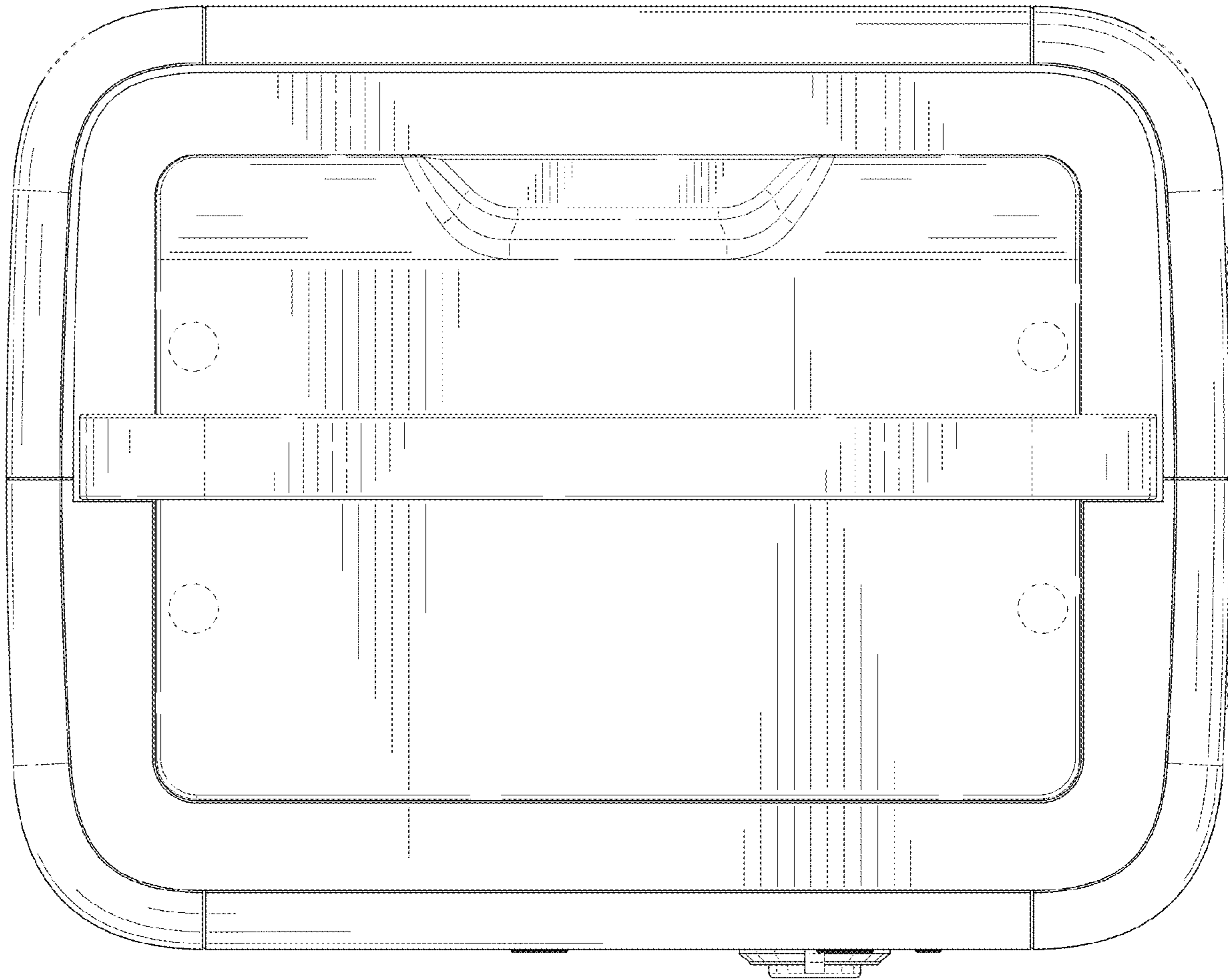

FIG. 7

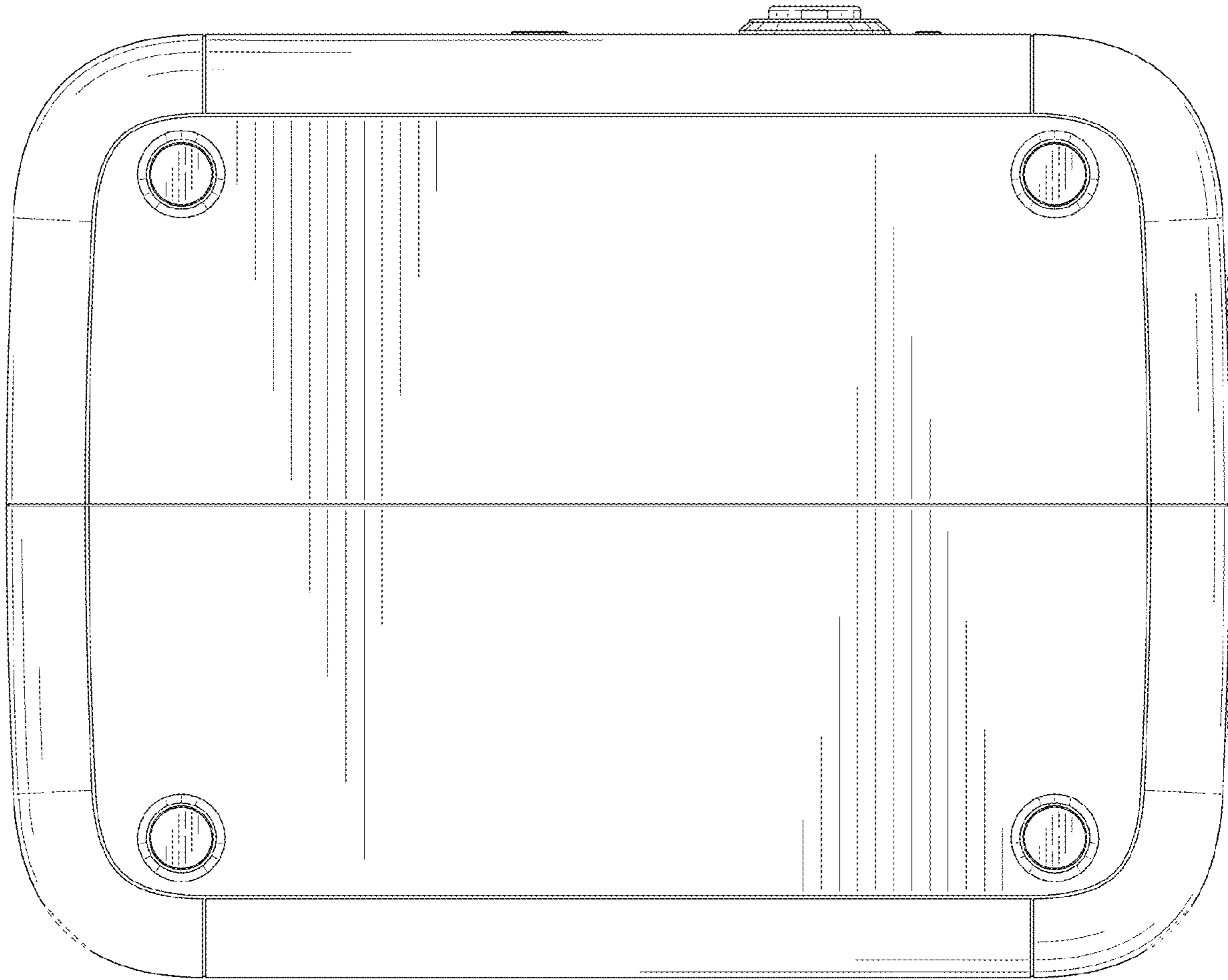

FIG. 8

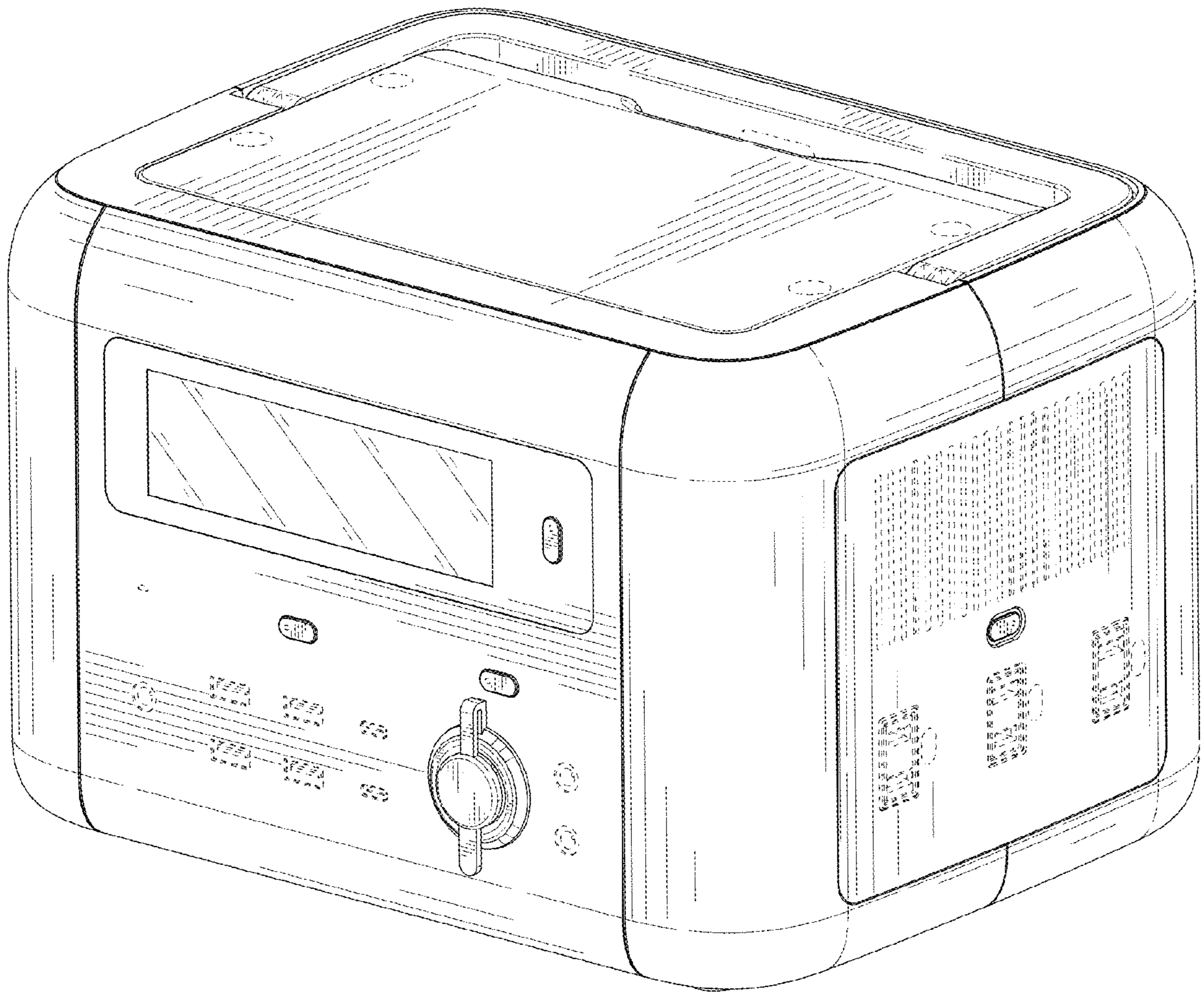

FIG. 9

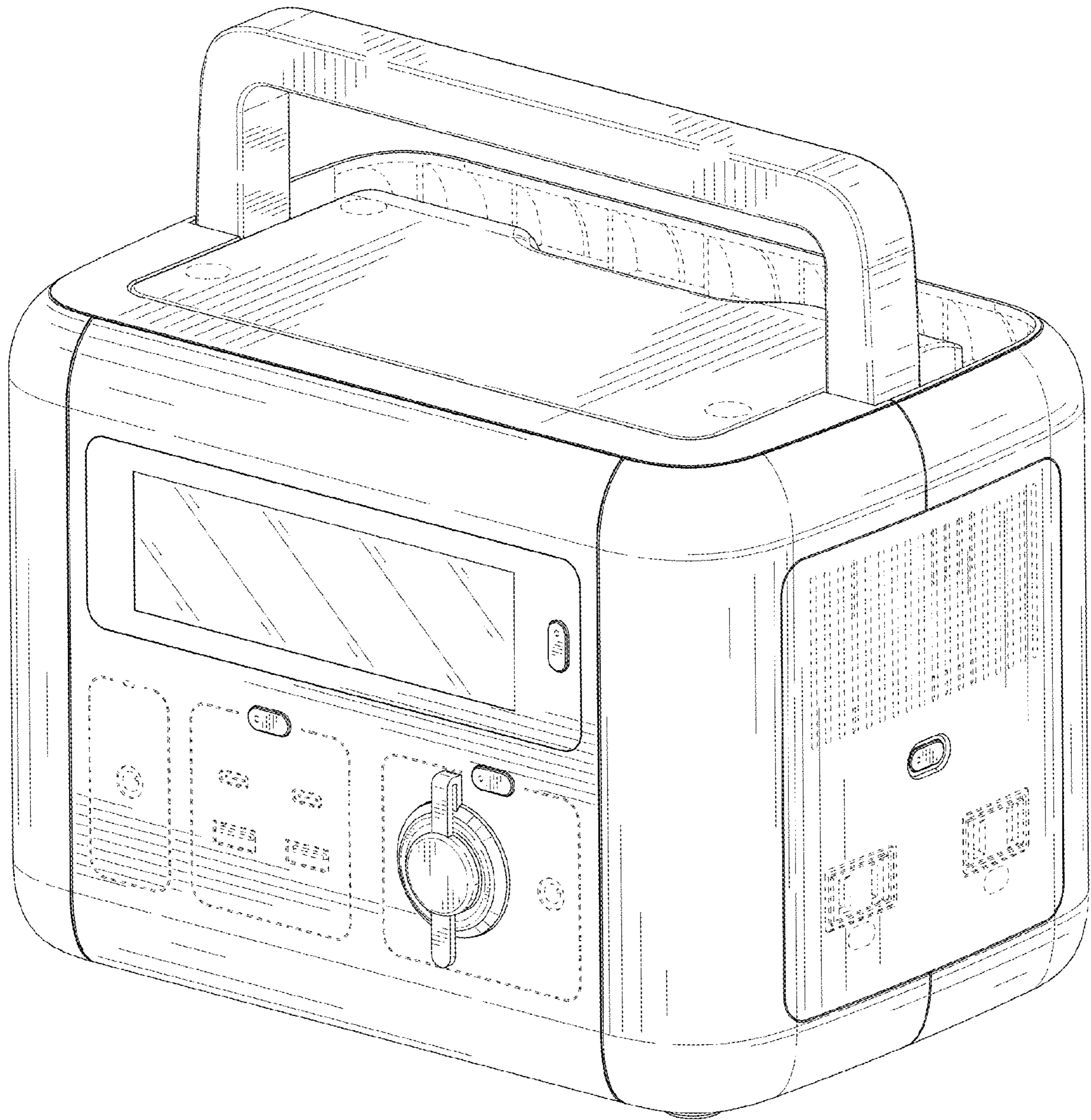

FIG. 10

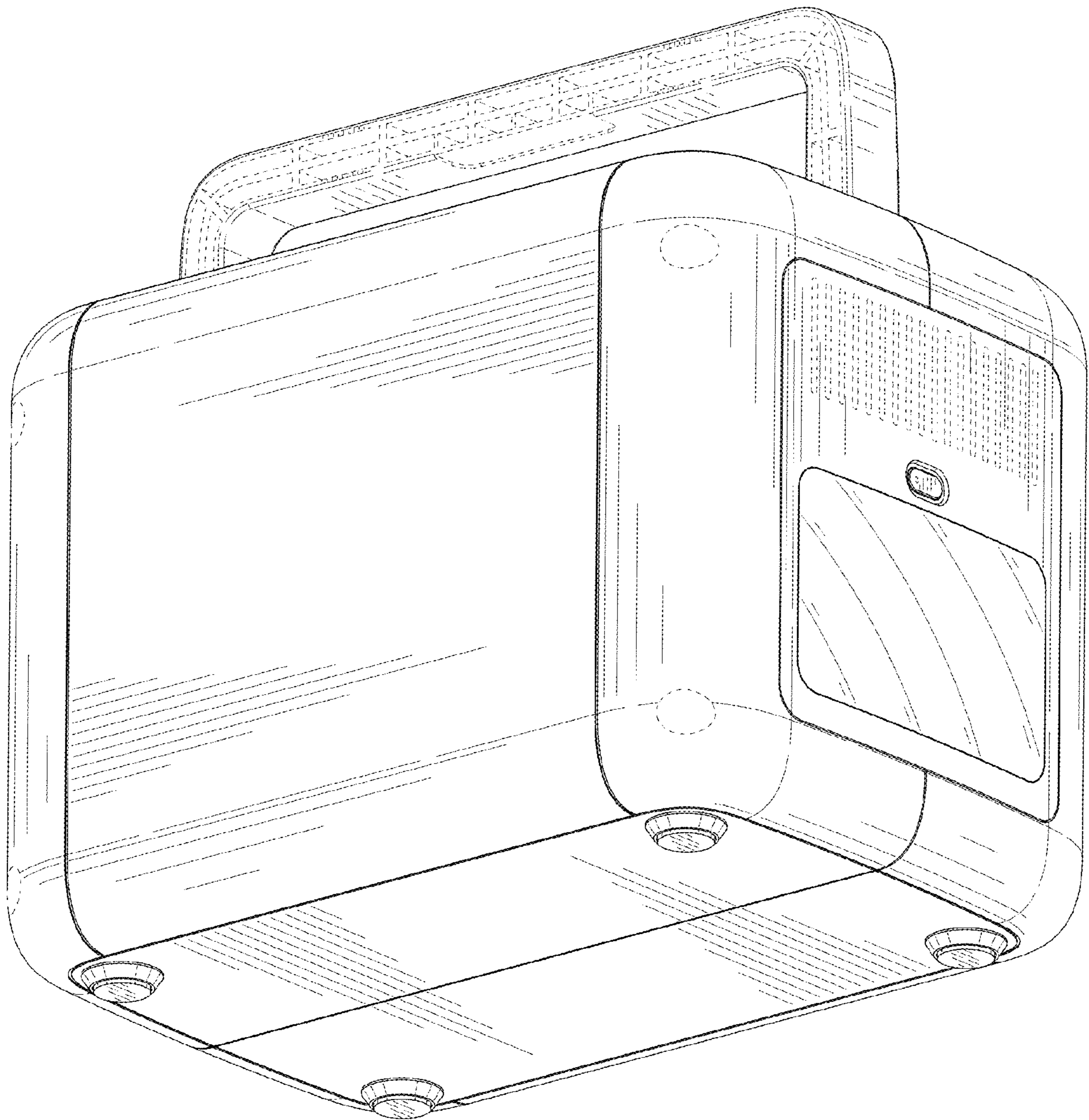

FIG. 11

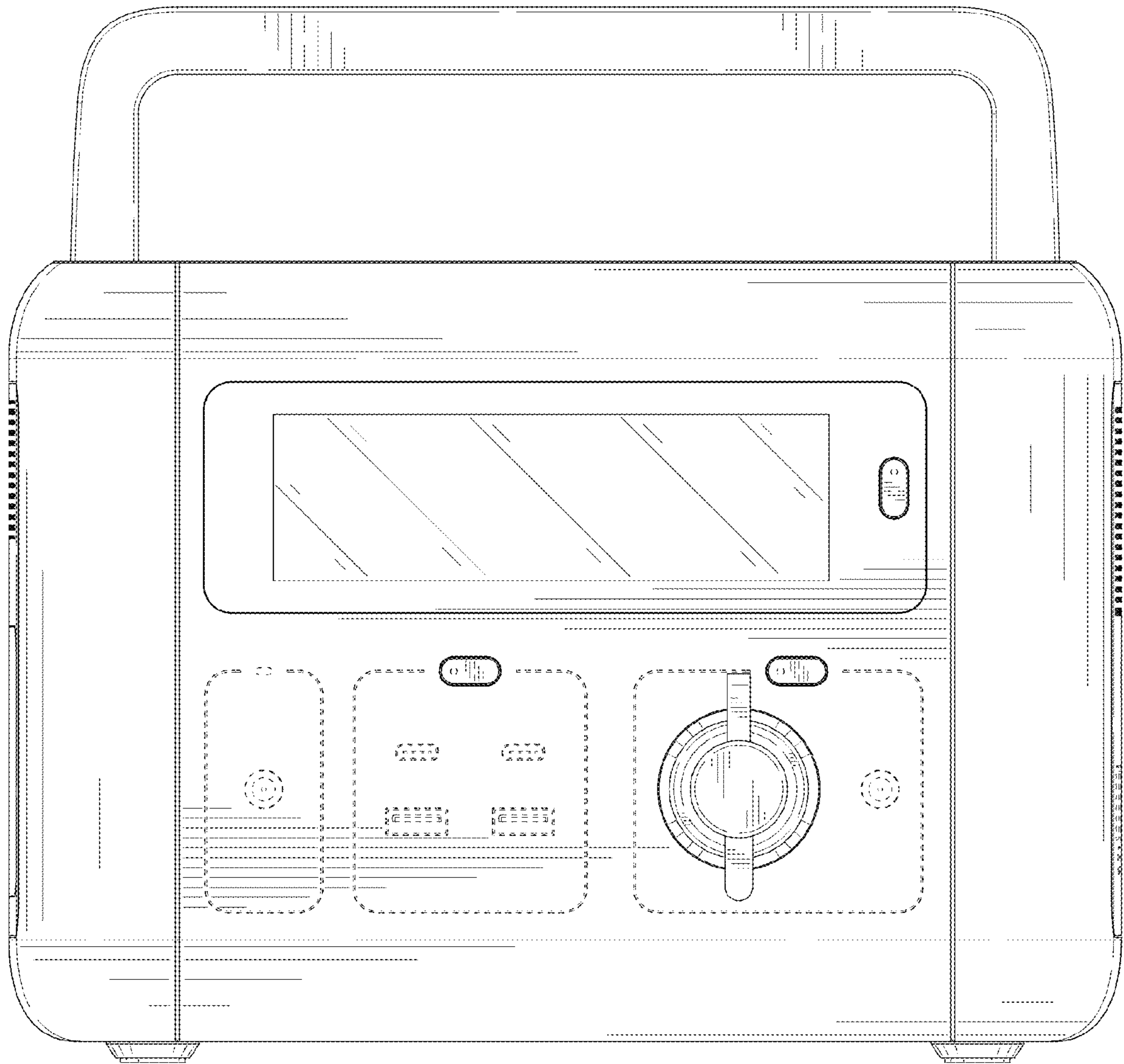

FIG. 12

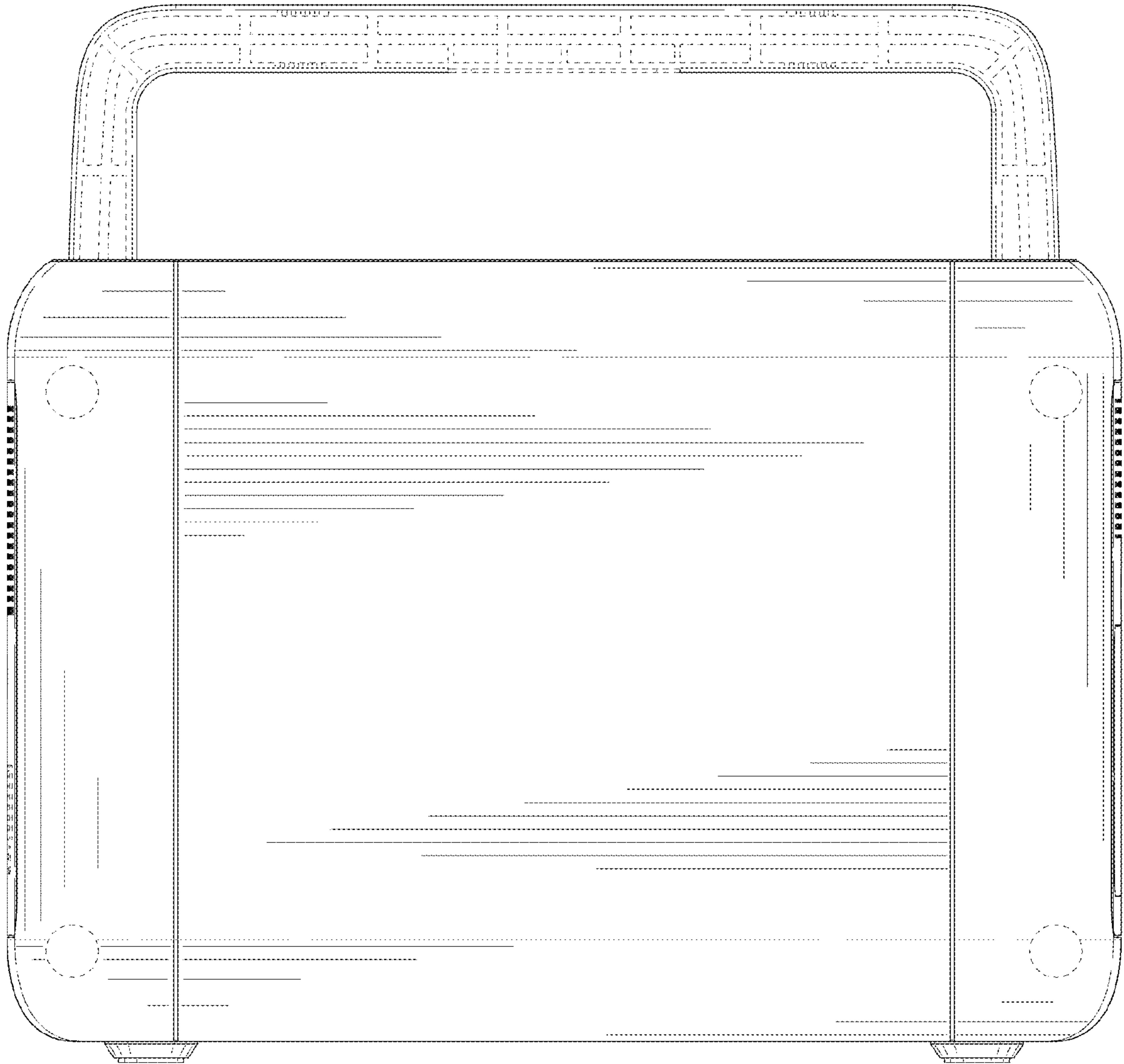

FIG. 13

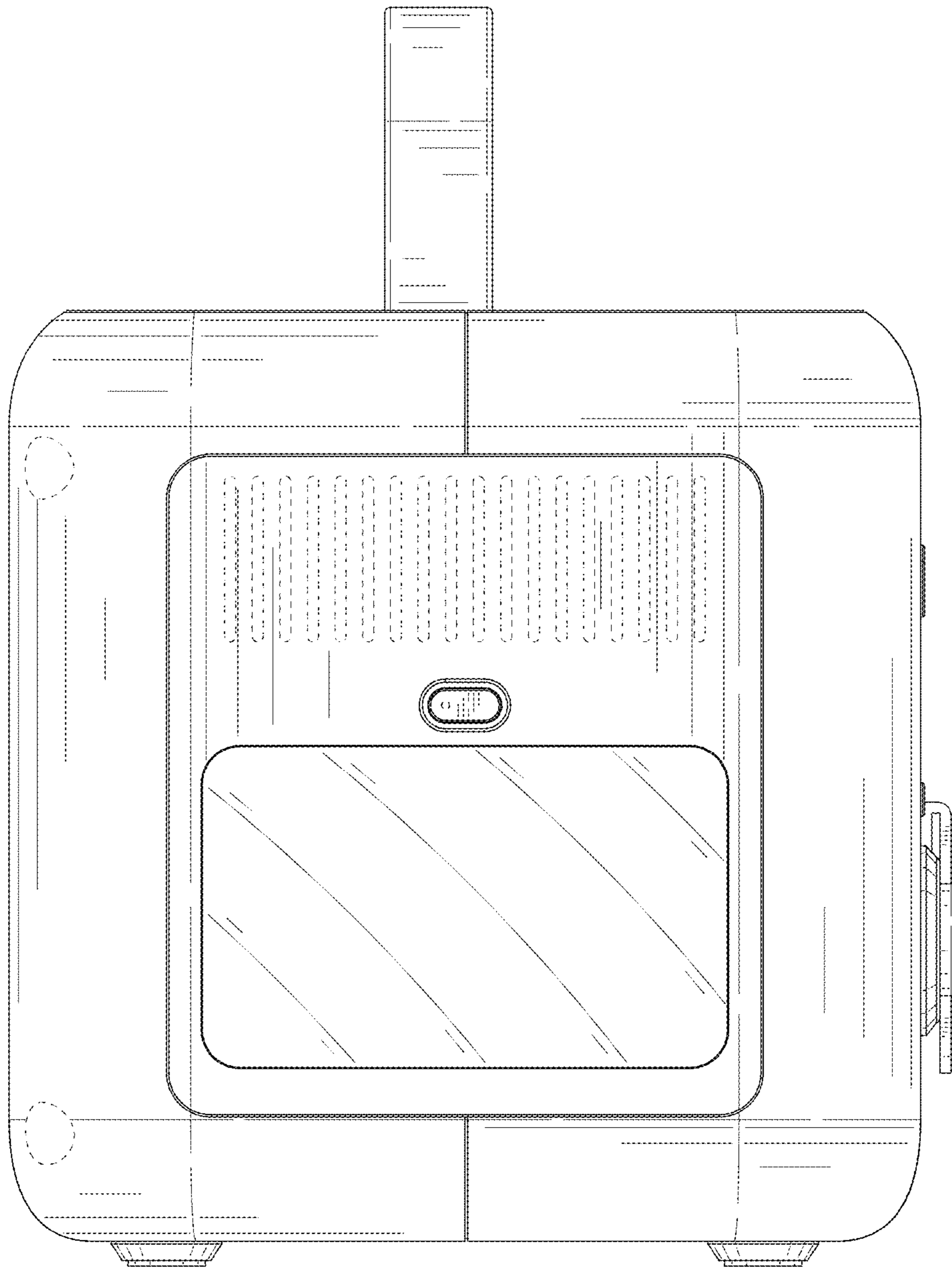

FIG. 14



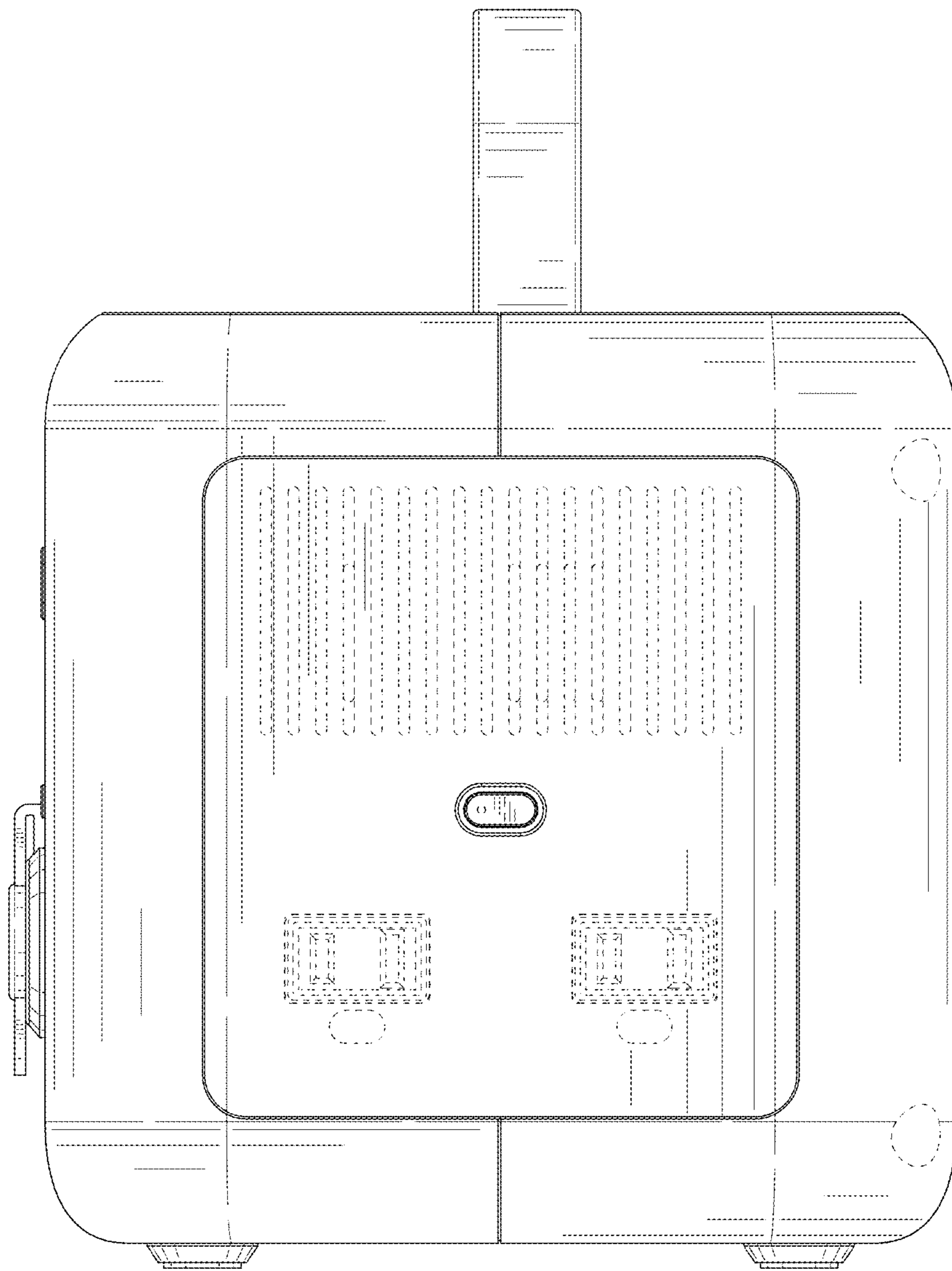

FIG. 15

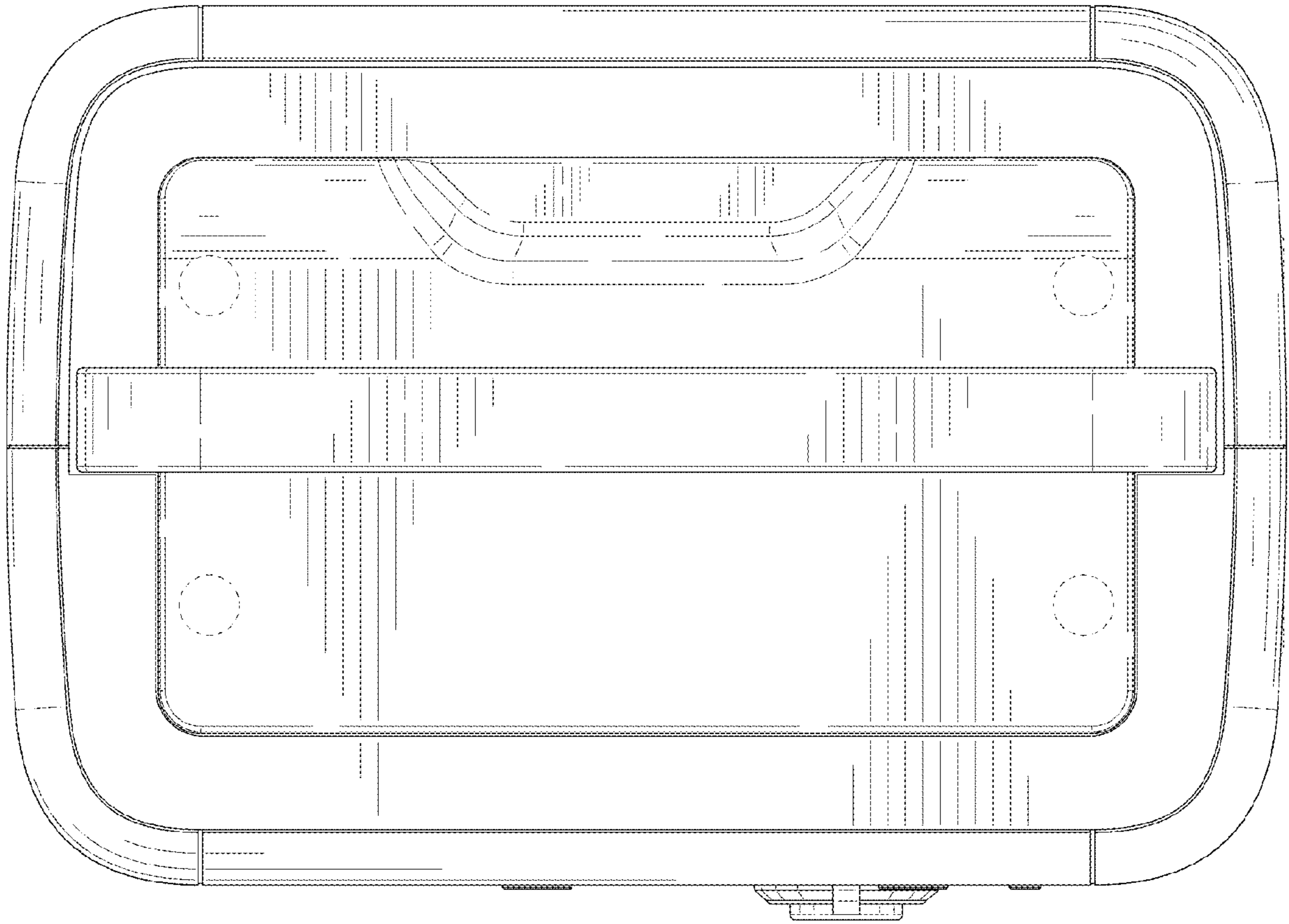

FIG. 16

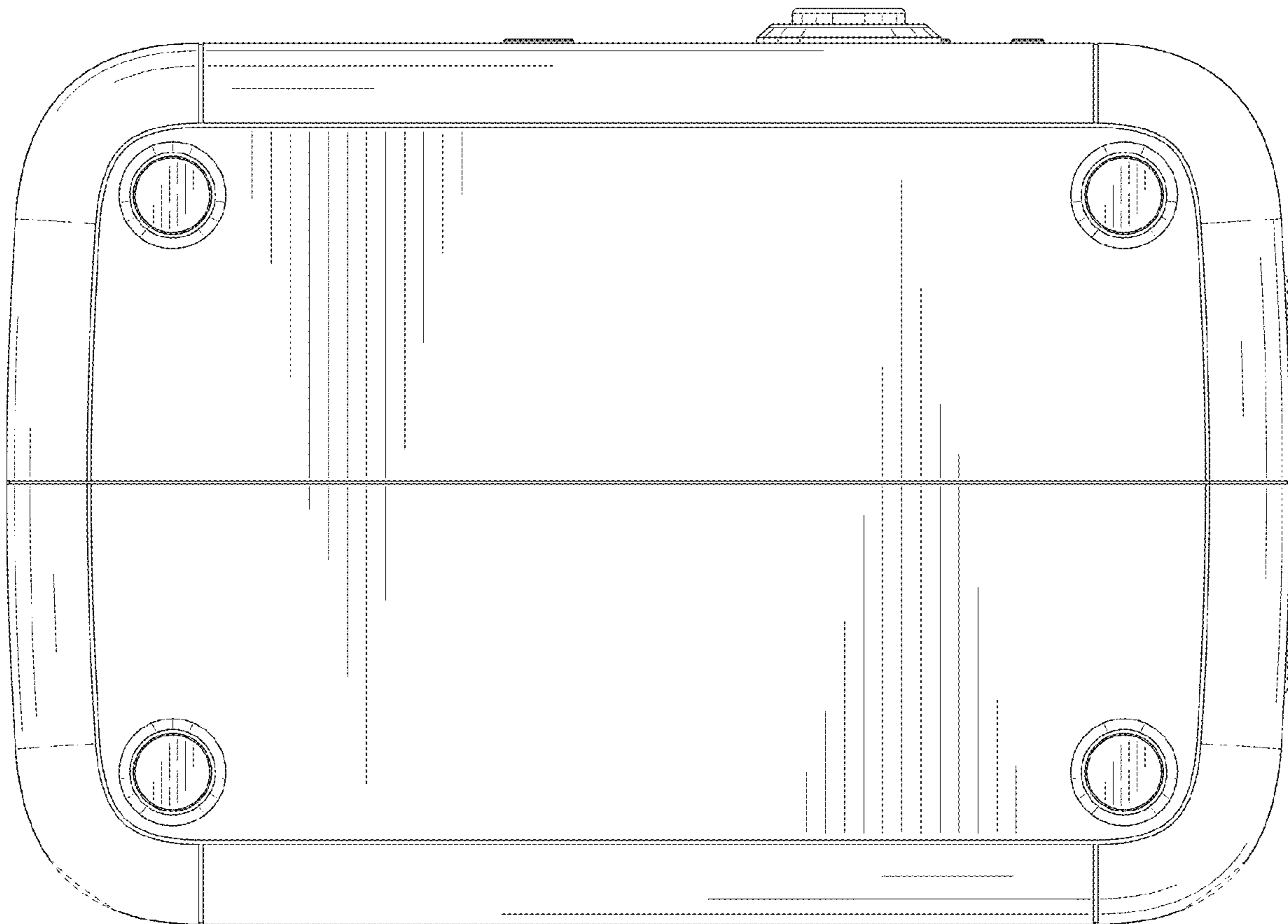

FIG. 17

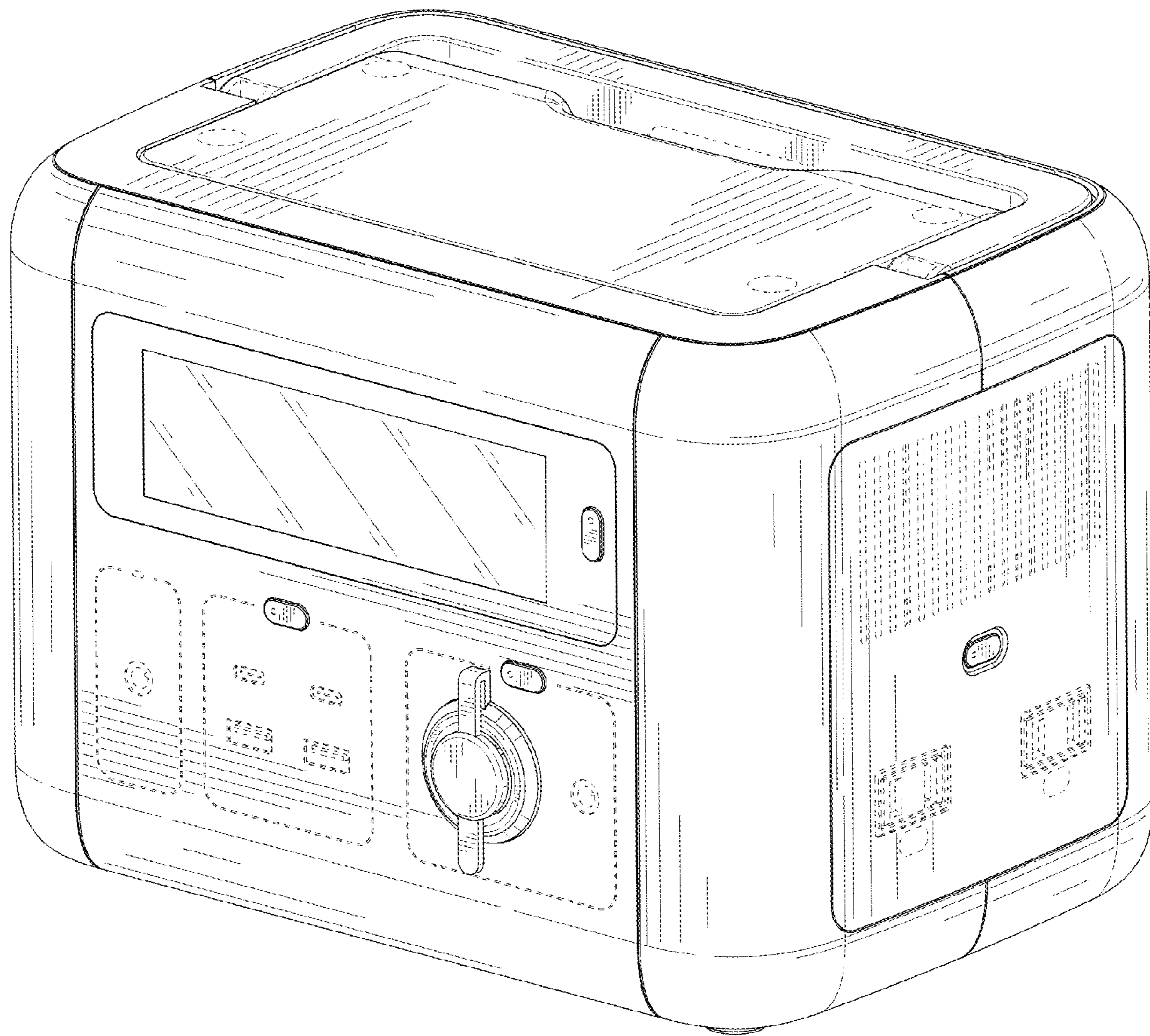

FIG. 18