



US00D972948S

(12) **United States Design Patent** (10) **Patent No.:** **US D972,948 S**
Mostov et al. (45) **Date of Patent:** **** Dec. 20, 2022**

(54) **GLOBAL POSITIONING DEVICE FOR TRACKING CARGO**

(71) Applicant: **Obshchestvo s ogranichennoy otvetstvennost'yu "KIRSEN"**, Saint Petersburg (RU)

(72) Inventors: **Kirill Mostov**, Saint Petersburg (RU); **Valeriy Alexeev**, Moscow (RU)

(73) Assignee: **Kirsen Integrated Solutions and Systems LLC**, Sparks, NV (US)

(**) Term: **15 Years**

(21) Appl. No.: **35/511,948**

(22) Filed: **Apr. 15, 2020**

(80) **Hague Agreement Data**

Int. Filing Date: **Apr. 15, 2020**

Int. Reg. No.: **DM/214459**

Int. Reg. Date: **Apr. 15, 2020**

Int. Reg. Pub. Date: **Jun. 4, 2021**

(51) **LOC (13) Cl.** **10-04**

(52) **U.S. Cl.**
USPC **D10/70**

(58) **Field of Classification Search**
USPC **D10/65, 70**
See application file for complete search history.

(56) **References Cited**

U.S. PATENT DOCUMENTS

D584,646 S * 1/2009 Sanguinetti D10/65
D611,361 S * 3/2010 Knight D10/70
D616,773 S 6/2010 Hou

D675,946 S * 2/2013 Chan D10/70
D688,576 S * 8/2013 Tsai D10/70
D693,248 S * 11/2013 Anderssen D10/70
D693,249 S * 11/2013 Anderssen D10/70
D693,709 S * 11/2013 Lee D10/70
D700,081 S * 2/2014 Balschweit D10/70
D719,857 S * 12/2014 Groener D10/70
D720,245 S * 12/2014 Neigher D10/70
D724,970 S * 3/2015 Hasegawa D10/70
D750,510 S * 3/2016 Lenz D10/70
D788,610 S * 6/2017 Venth D10/70
D797,584 S * 9/2017 Venth D10/70
D815,625 S * 4/2018 Wartmann D14/240
D823,703 S * 7/2018 Pan D10/65
D833,896 S * 11/2018 Fischer D10/65
D844,467 S * 4/2019 Maguire D10/65
D947,046 S * 3/2022 Lenz D10/65

* cited by examiner

Primary Examiner — George D. Kirschbaum
(74) *Attorney, Agent, or Firm* — Patentagar PLLC;
Alexander Rabinovich

(57) **CLAIM**

The ornamental design for a global positioning device for tracking cargo, as shown and described in the Embodiment on Figures 4.1-4.7.

DESCRIPTION

- 4. Global positioning device for tracking cargo
- 4.1 : Top
- 4.2 : Left
- 4.3 : Front
- 4.4 : Right
- 4.5 : Back
- 4.6 : Bottom
- 4.7 : Perspective

1 Claim, 28 Drawing Sheets

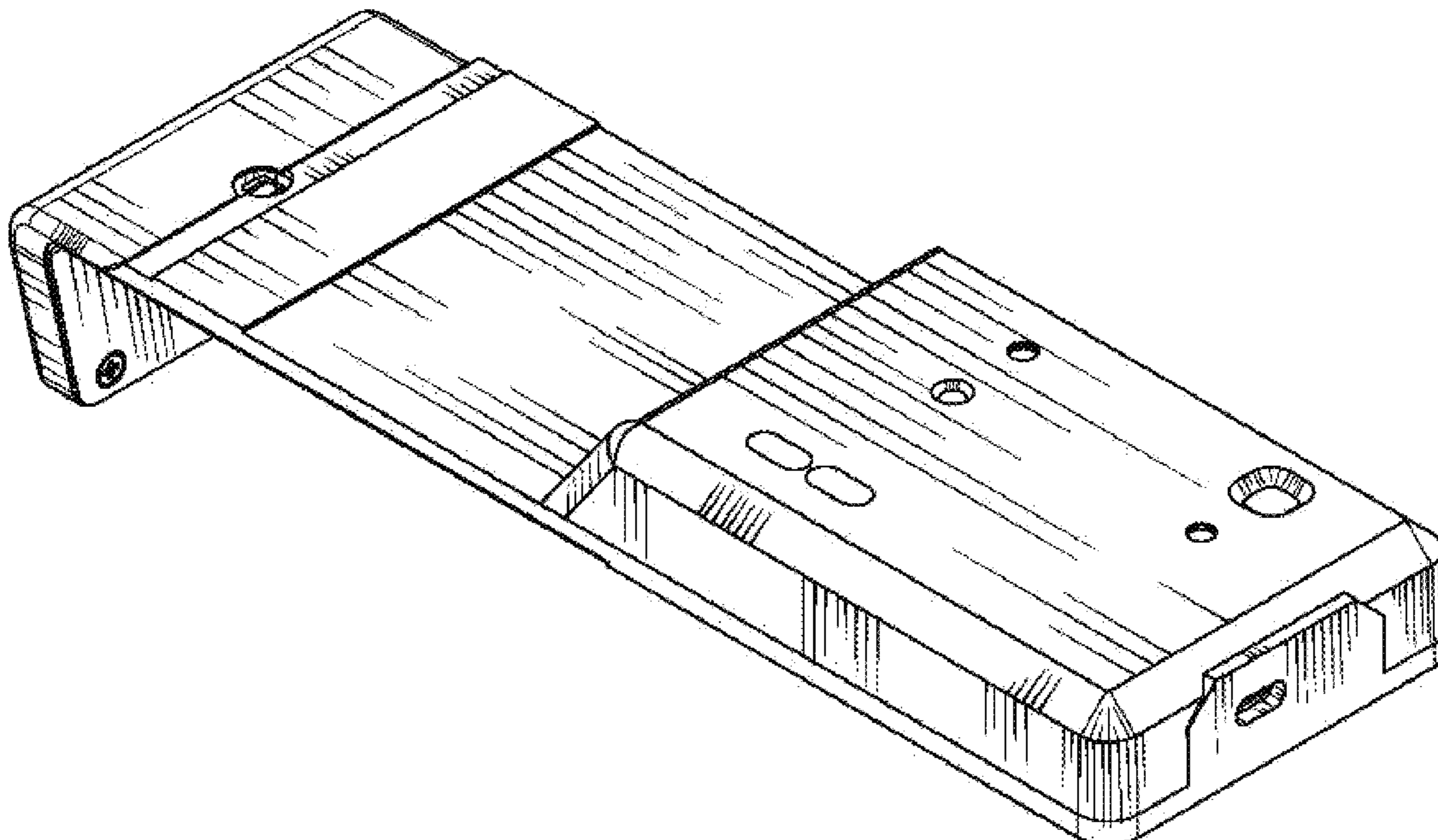

1.1

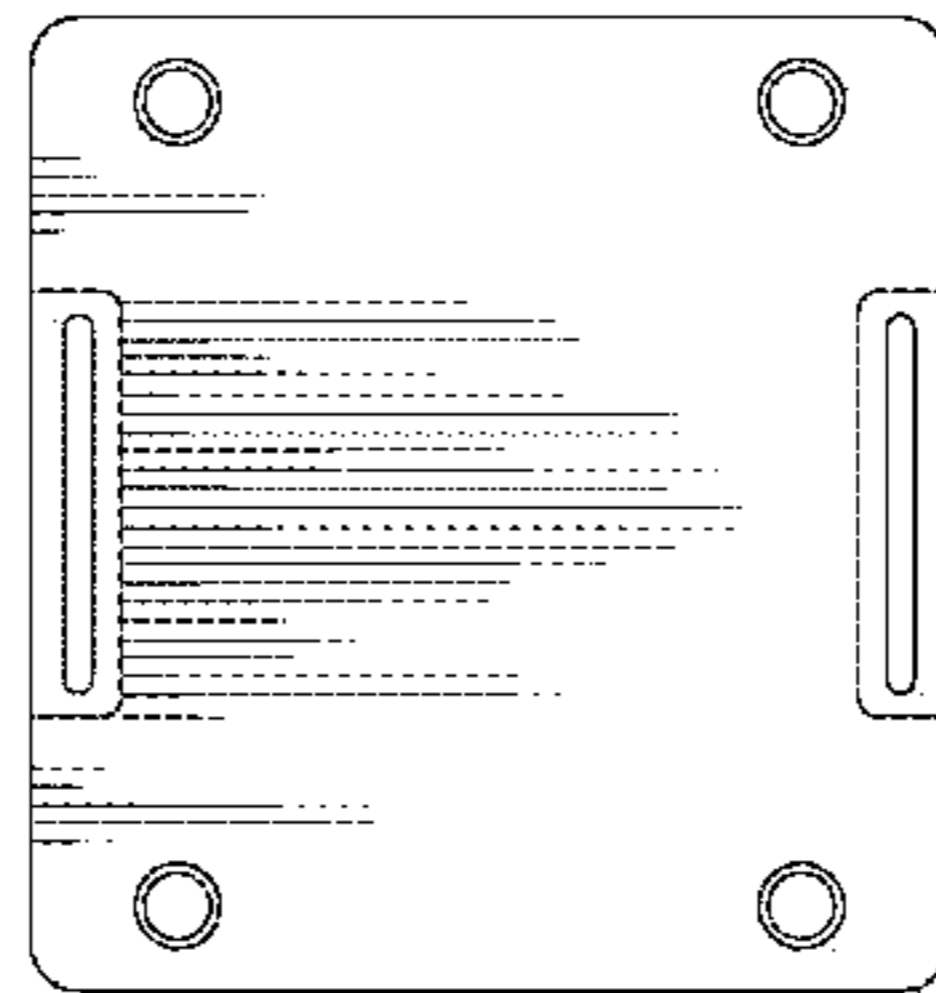

1.2

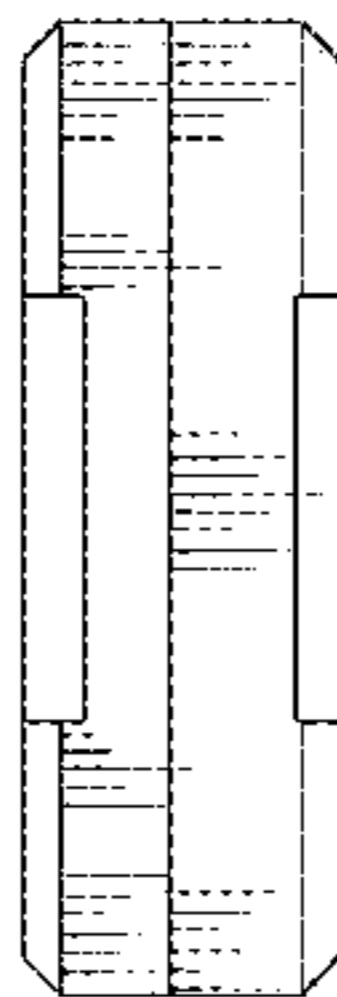

1.3

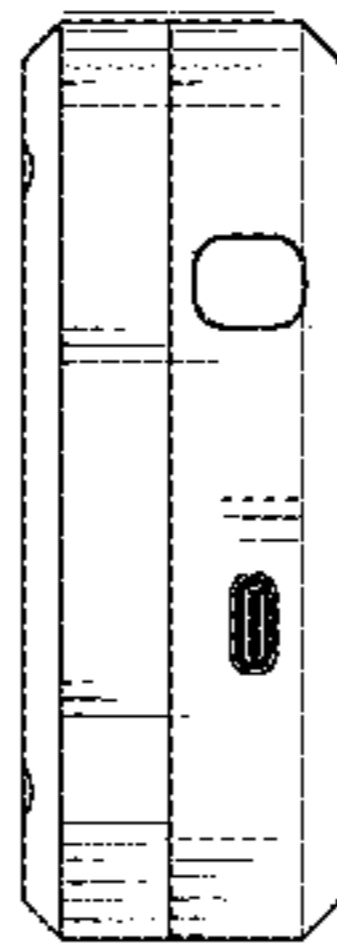

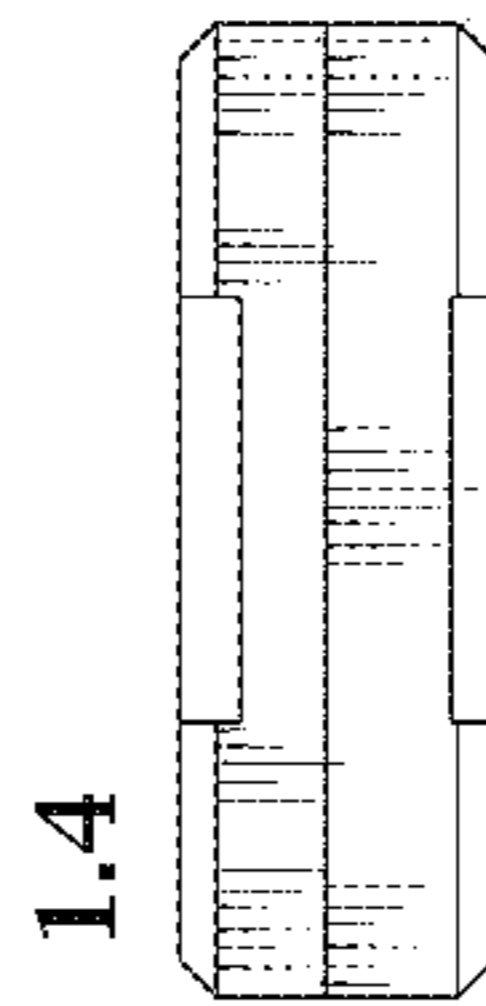

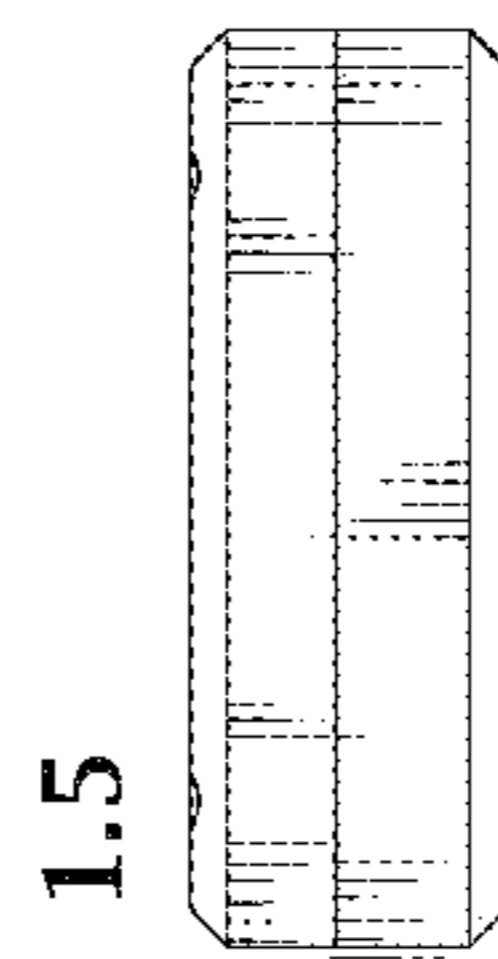

1.6

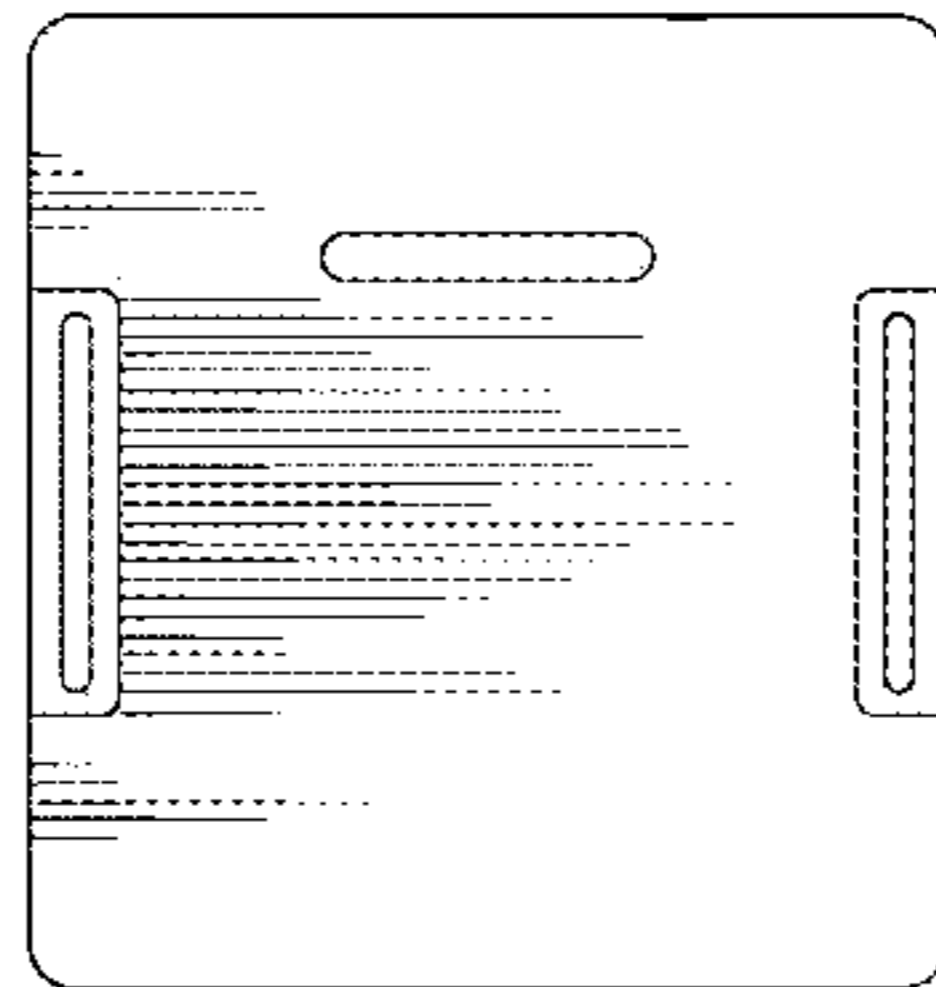

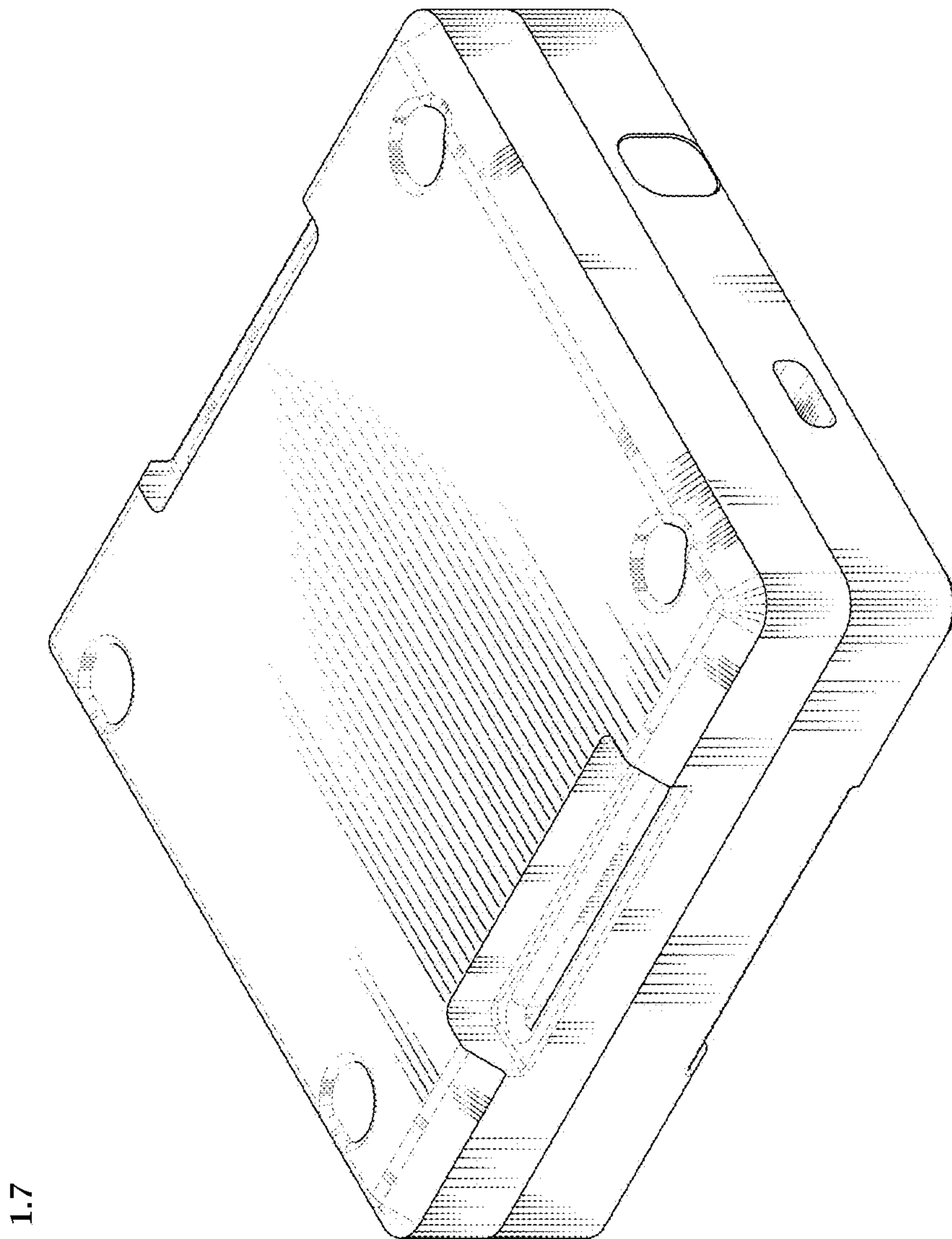

1.7

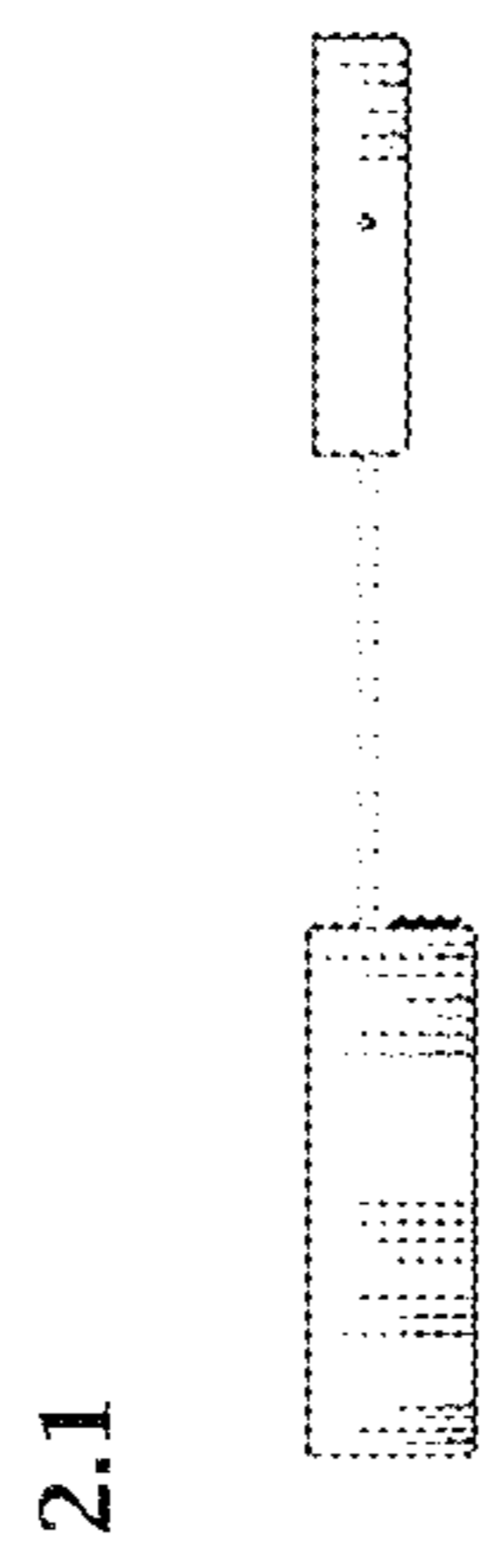

2.2



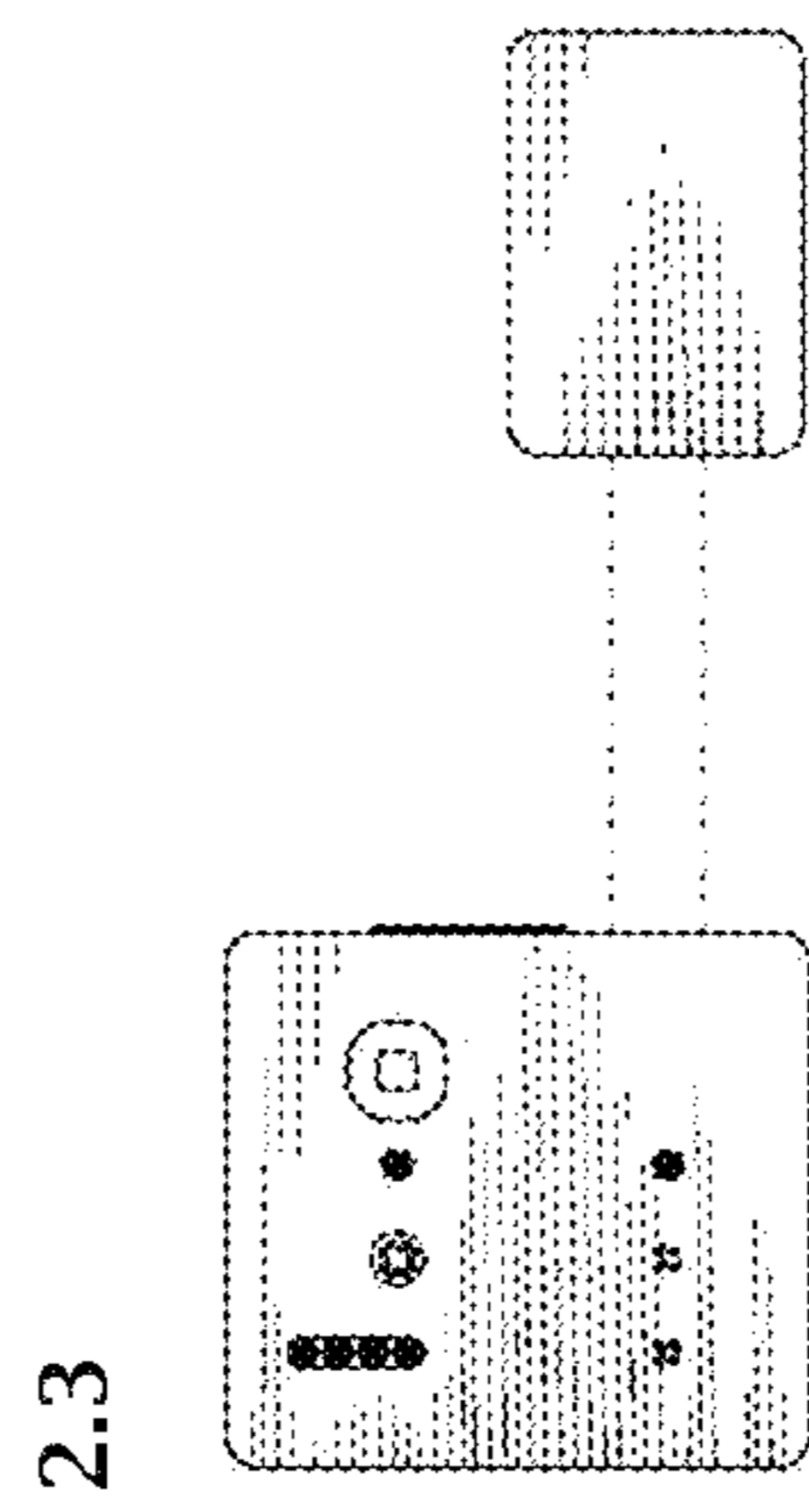

2.4

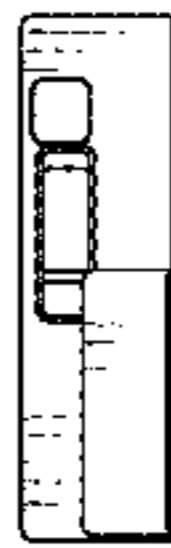

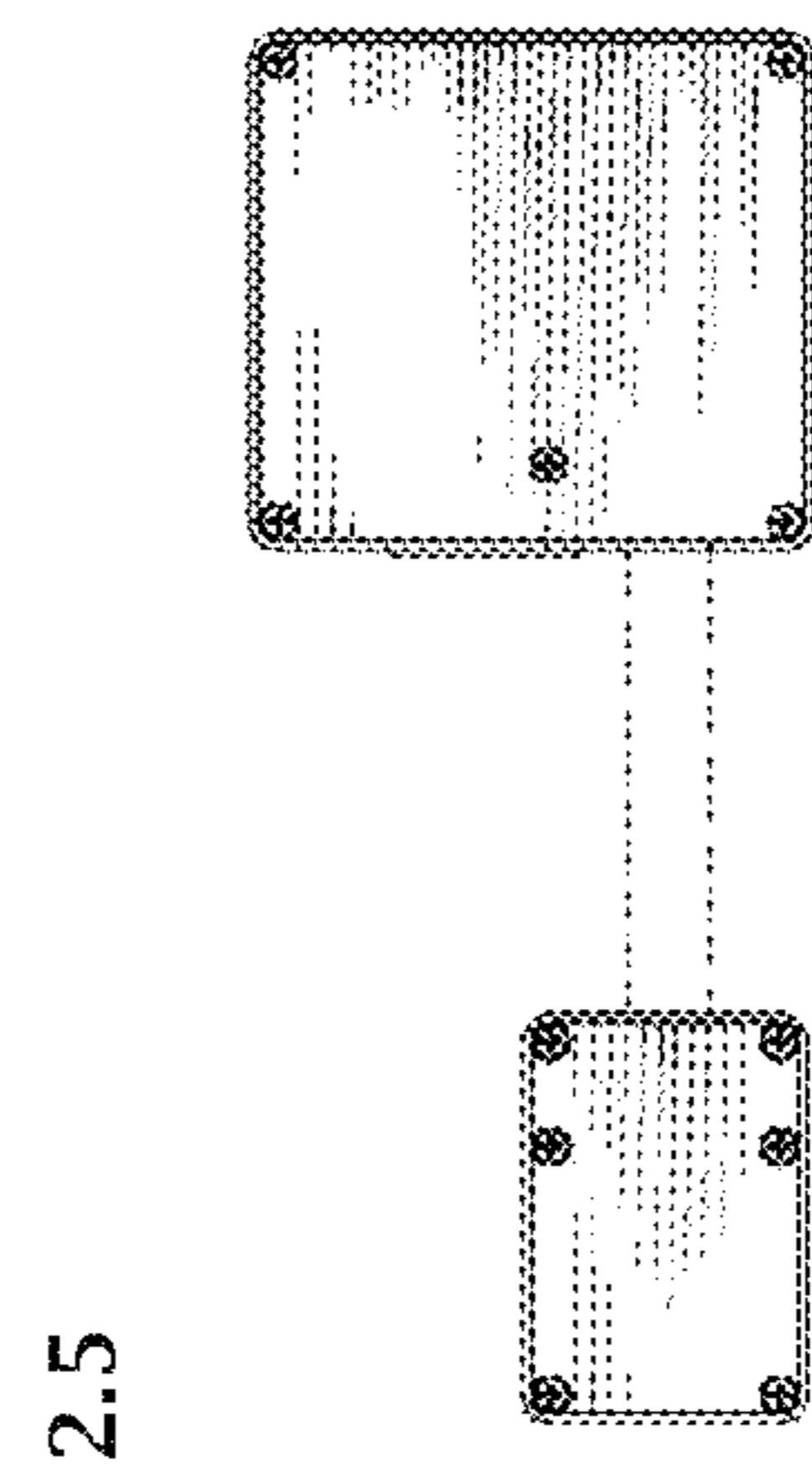

2.6

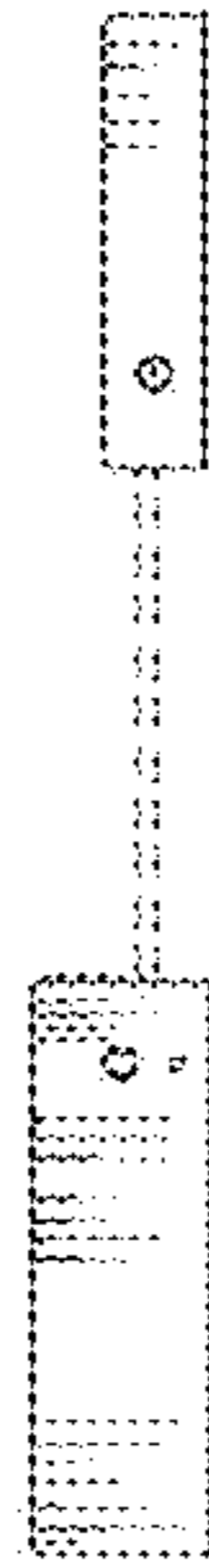

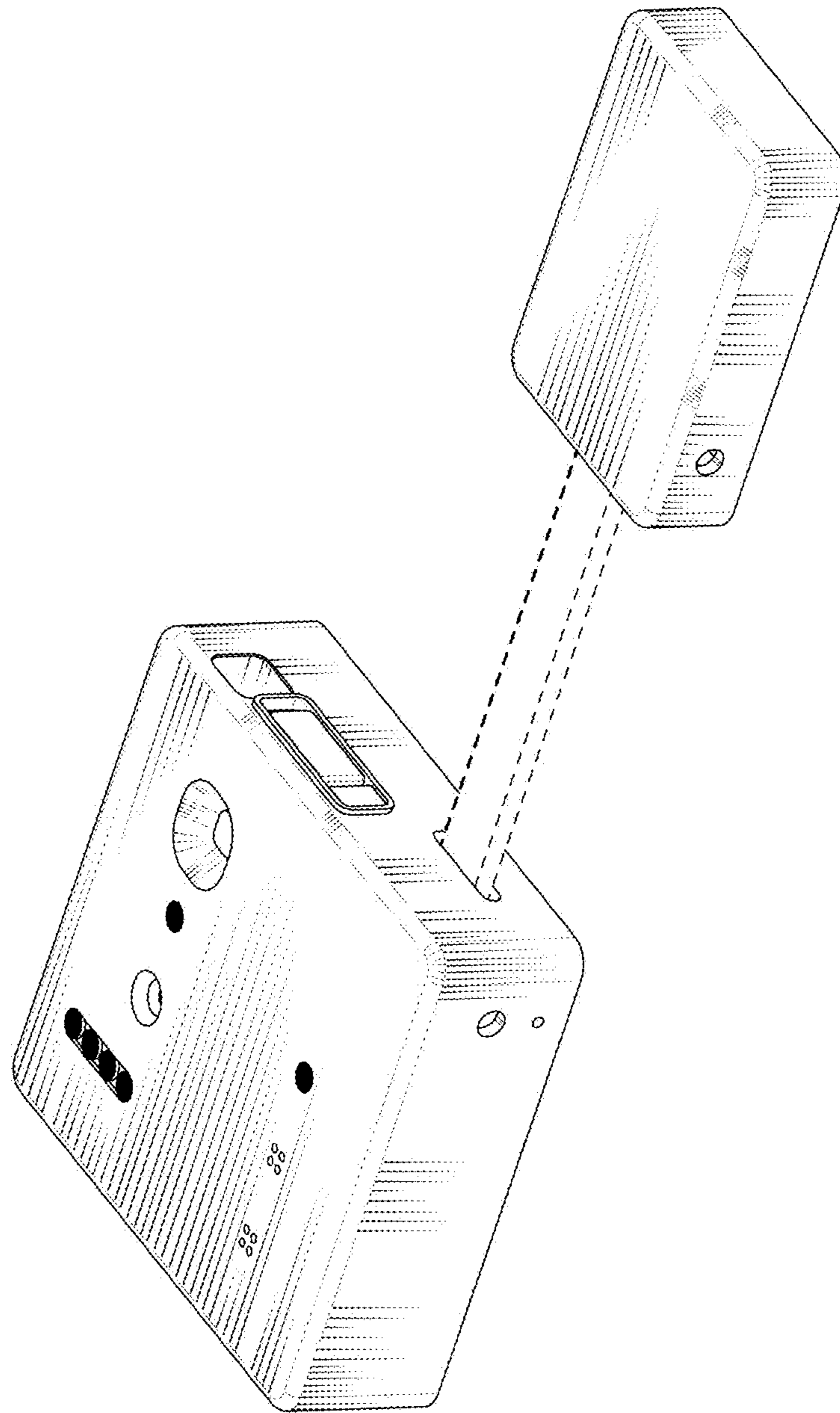

2.7

3.1

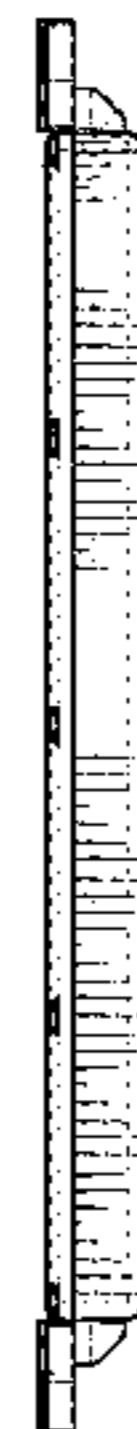

3.2

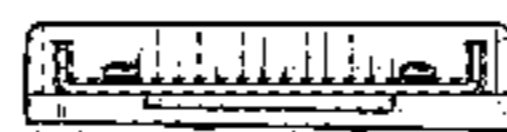

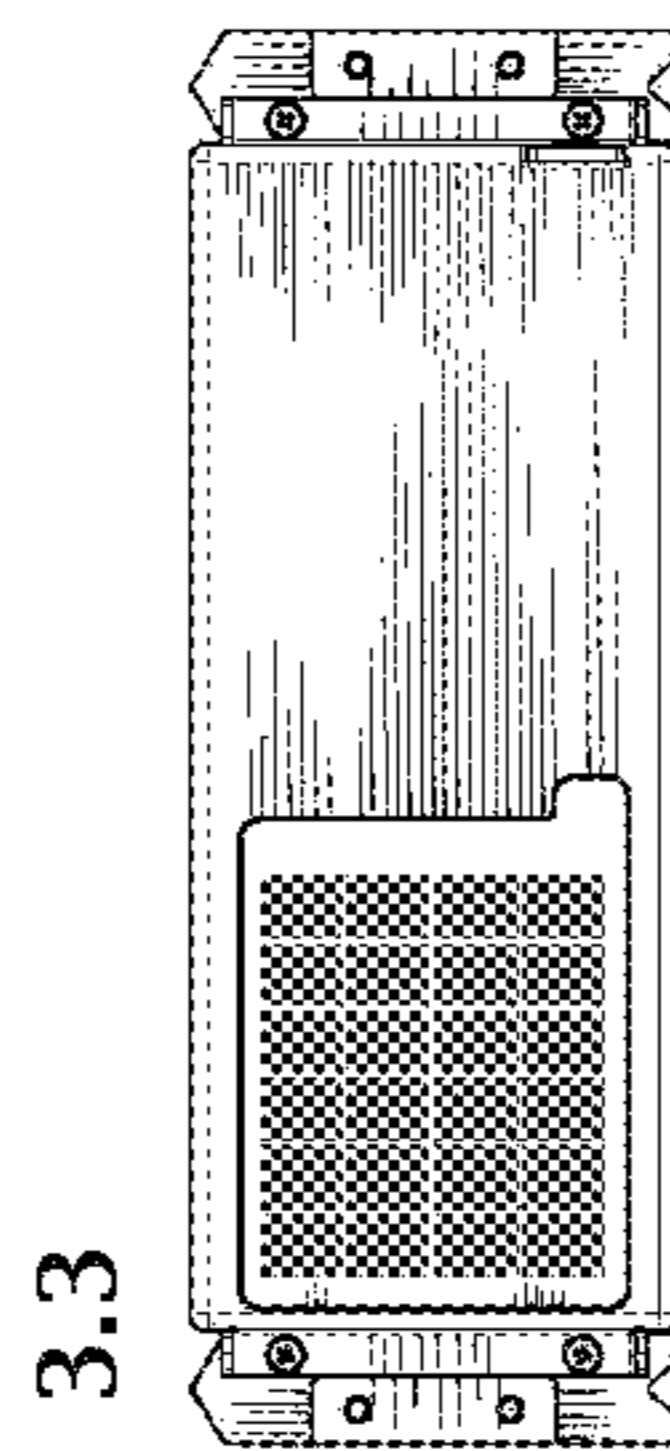

3.4

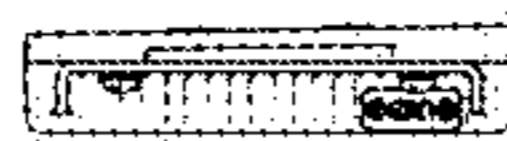

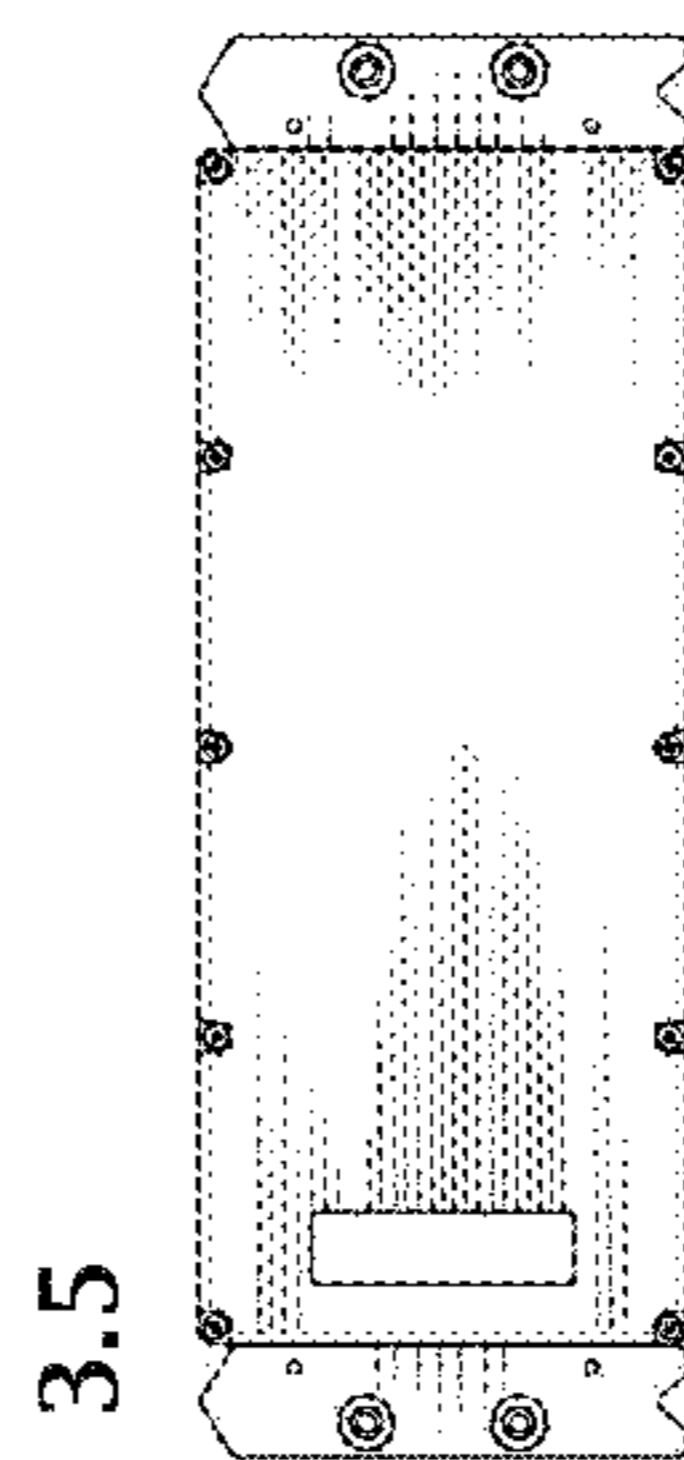

3.6



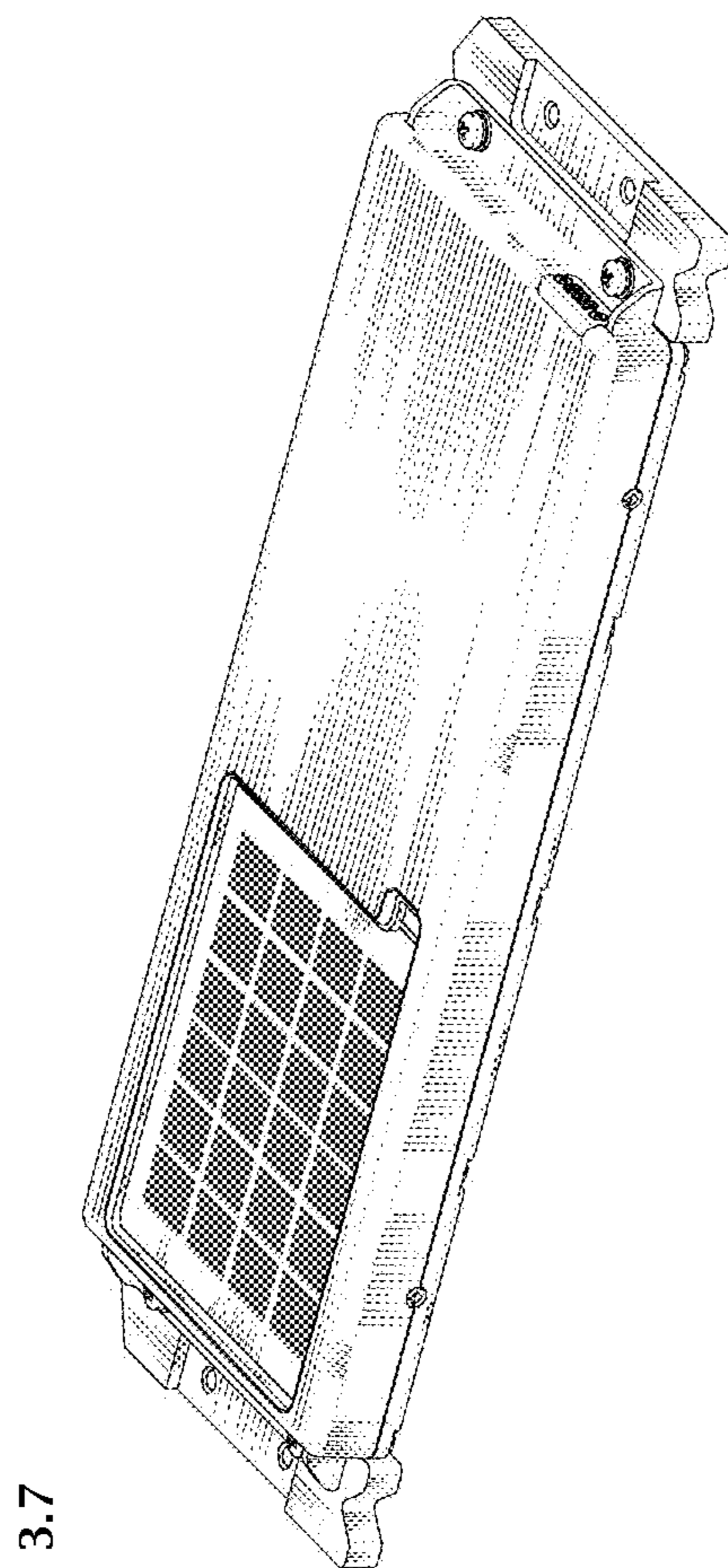

3.7

4.1

