



US00D972848S

(12) **United States Design Patent** (10) **Patent No.:** **US D972,848 S**  
**Li** (45) **Date of Patent:** **\*\* Dec. 20, 2022**

(54) **SHOWER BRUSH**  
(71) Applicant: **Chengdu Mocui Technology Co., Ltd.,**  
Sichuan (CN)  
(72) Inventor: **Shurui Li, Neijiang (CN)**  
(73) Assignee: **Chengdu Mocui Technology Co., Ltd.,**  
Sichuan (CN)

D943,286 S \* 2/2022 Xiao ..... D4/120  
D945,777 S \* 3/2022 Wang ..... D4/119  
D957,133 S \* 7/2022 Wei ..... D4/104

**FOREIGN PATENT DOCUMENTS**

CN 304516631 \* 2/2018  
CN 304982843 \* 1/2019  
CN 306436312 \* 4/2021

**OTHER PUBLICATIONS**

3Pcs Long Handle Shower Brush [on-line]. [Original date of publication unknown.] [Retrieved from the Internet on Aug. 10, 2022.] URL: <https://www.ebay.com/itm/265777737542?var=565562044735&mkevt=1&mkcid=1&mkrid=711-53200-19255-0&toolid=10050&campid=5338675951&customid=16601772143391779570010070301008005&amdata=enc%3A1AWBQDV9IQOimAceHda0oAA90> (Year: 2022).\*

\* cited by examiner

*Primary Examiner* — Karen E Eldridge Powers  
(74) *Attorney, Agent, or Firm* — ScienBiziP, P.C.

(57) **CLAIM**

The ornamental design for a shower brush, as shown and described.

**DESCRIPTION**

FIG. 1 is a front, bottom and left side perspective view of a shower brush showing my design;  
FIG. 2 is a front elevation view thereof.  
FIG. 3 is a rear elevation view thereof.  
FIG. 4 is a left side elevation view thereof.  
FIG. 5 is a right side elevation view thereof.  
FIG. 6 is a top plan view thereof; and,  
FIG. 7 is a bottom plan view thereof.

**1 Claim, 7 Drawing Sheets**

(\*\*) Term: **15 Years**  
(21) Appl. No.: **29/750,511**  
(22) Filed: **Sep. 14, 2020**  
(51) **LOC (13) Cl.** ..... **28-03**  
(52) **U.S. Cl.**  
USPC ..... **D4/134; D28/63**  
(58) **Field of Classification Search**  
USPC ..... D4/100, 102, 119, 120, 121, 122, 123,  
D4/127, 128, 129, 130, 132, 133, 134,  
D4/135, 136, 137, 138, 199; D30/158,  
D30/159; D24/211, 212, 213, 214, 215;  
D28/63  
CPC ..... A46B 5/02; A46B 7/023; A46B 7/026;  
A46B 9/02; A46B 2200/10; A46B  
5/0004; A46B 13/008; A46B 15/0055  
See application file for complete search history.

(56) **References Cited**

**U.S. PATENT DOCUMENTS**

D206,792 S \* 1/1967 Halberstadt ..... D4/120  
D227,623 S \* 7/1973 Spydevold ..... D4/134  
D523,642 S \* 6/2006 Hollinger ..... D4/134  
D825,192 S \* 8/2018 Duvall ..... A46B 5/0079  
D4/134  
D943,219 S \* 2/2022 Guo ..... D28/91.2

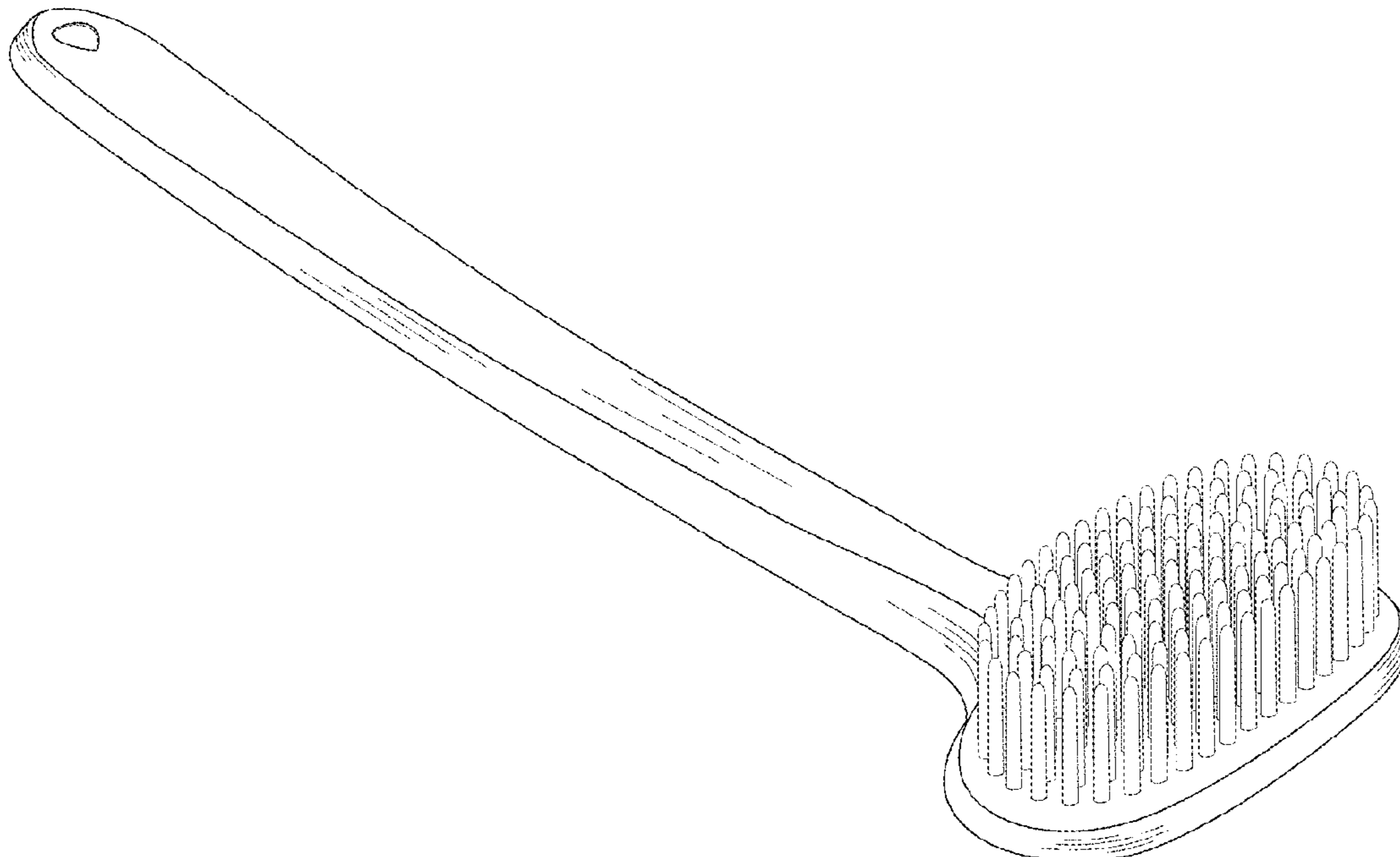

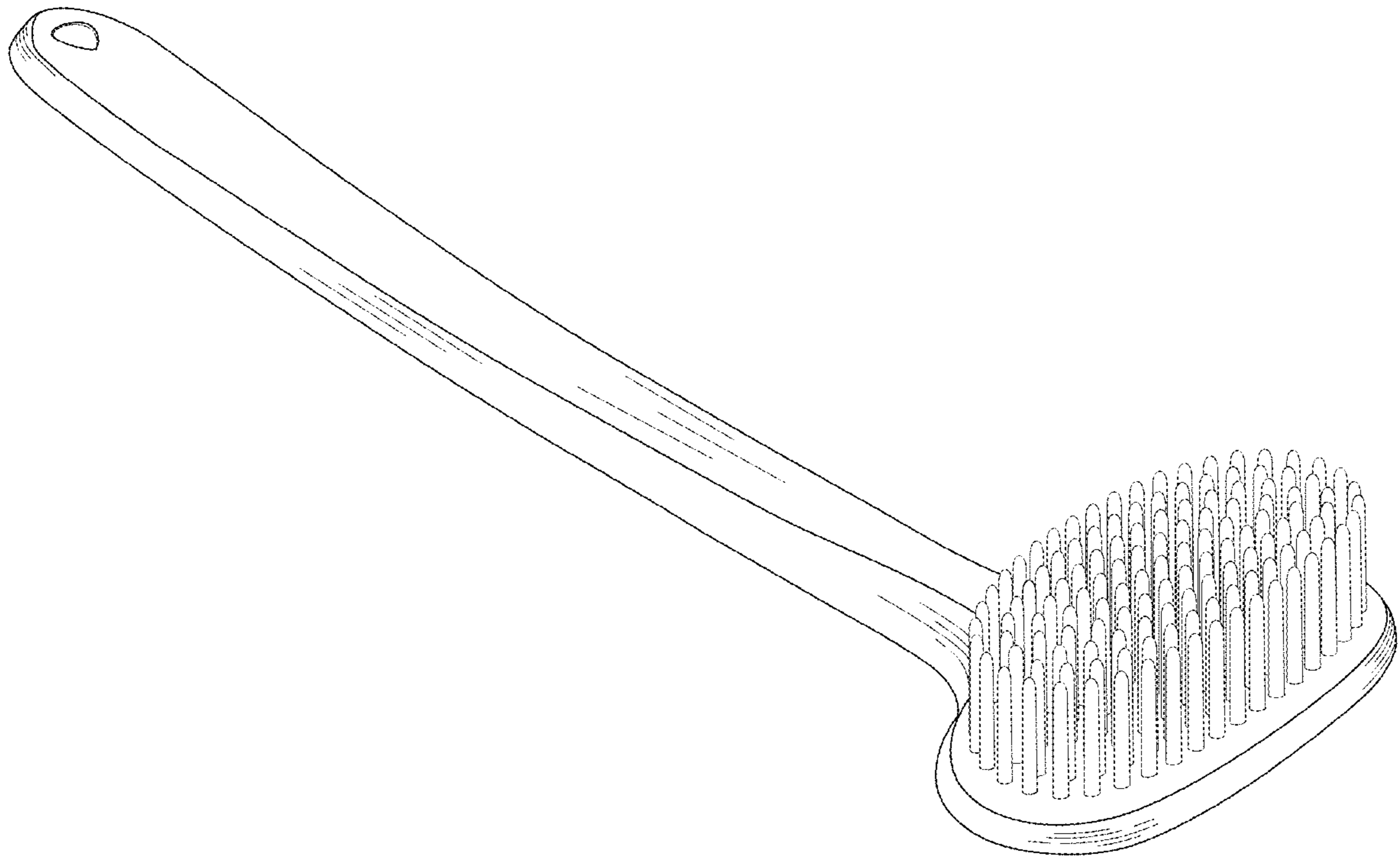

FIG. 1

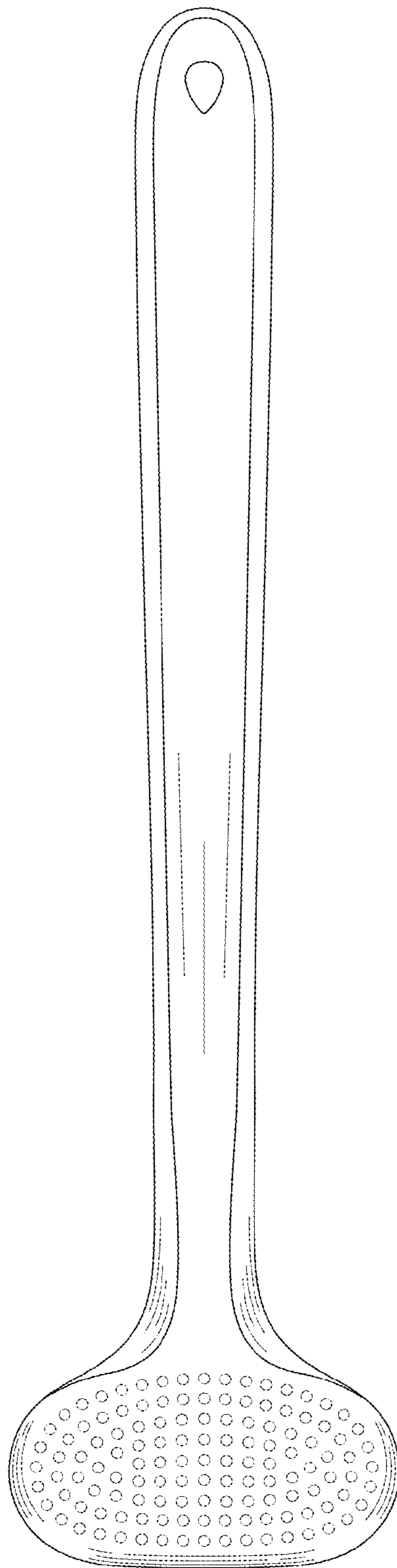

FIG. 2

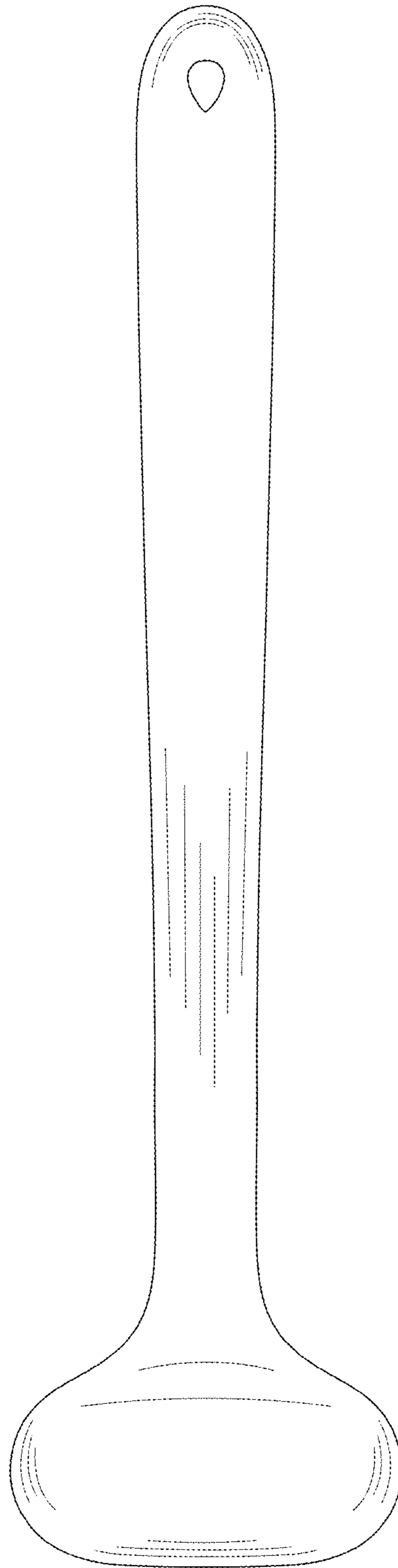

FIG.3

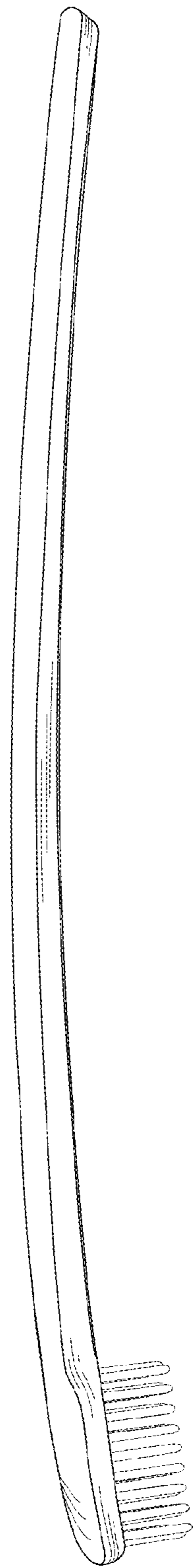

FIG. 4

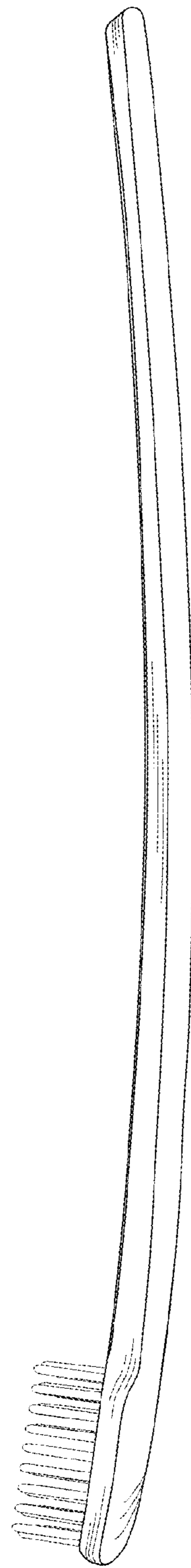

FIG.5

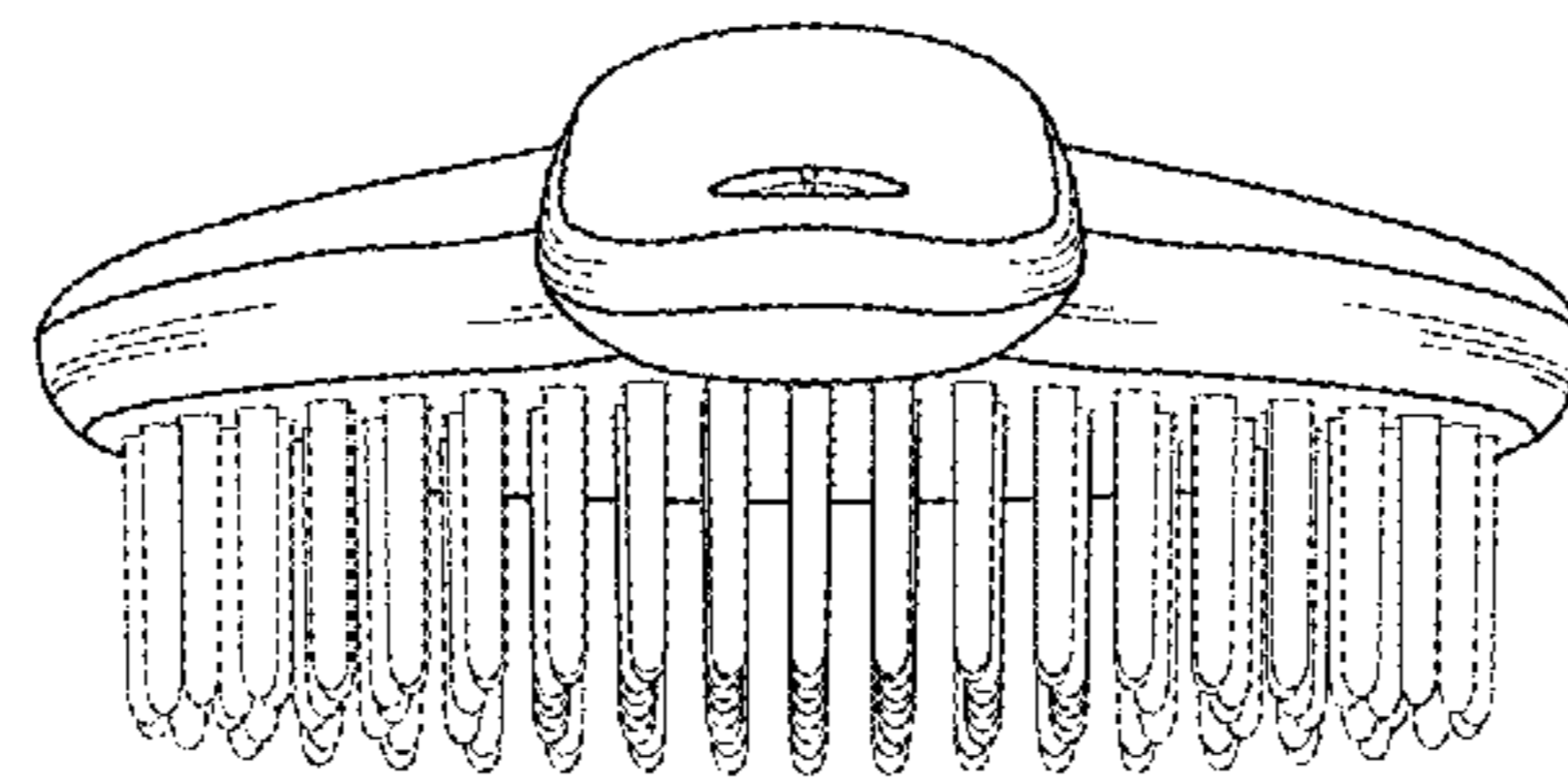

FIG.6

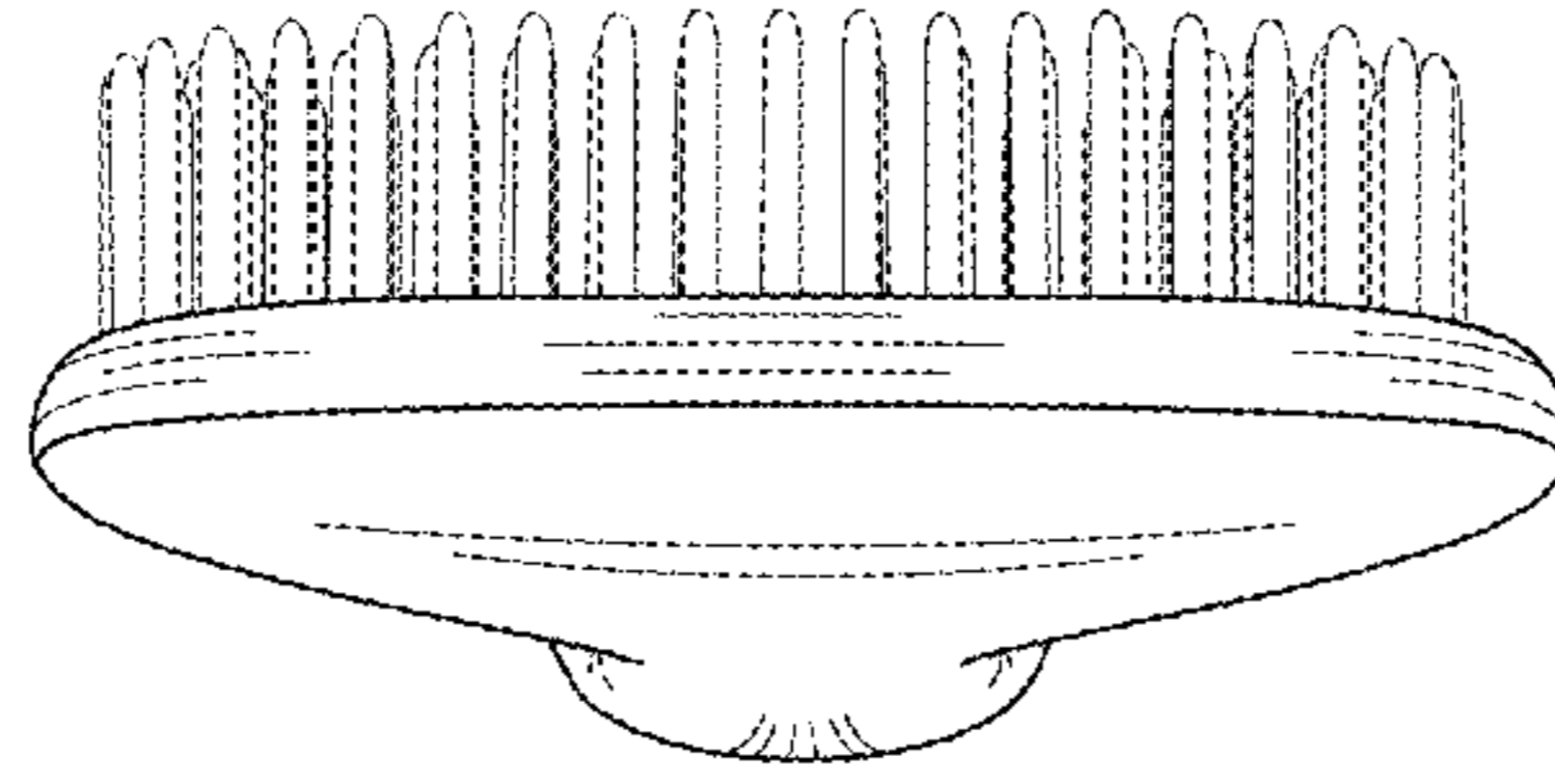

FIG.7





US00D972848C1

(12) **EX PARTE REEXAMINATION CERTIFICATE** (12545th)  
**United States Patent**  
**Li**

(10) **Number:** **US D972,848 C1**  
(45) **Certificate Issued:** **Mar. 20, 2024**

(54) **SHOWER BRUSH**

Appl. No.: **29/750,511**  
Filed: **Sep. 14, 2020**

(71) Applicant: **Chengdu Mocui Technology Co., Ltd.**,  
Sichuan (CN)

(51) **LOC (14) Cl.** ..... **28-03**

(72) Inventor: **Shurui Li**, Neijiang (CN)

(52) **U.S. Cl.**

USPC ..... **D4/134; D28/63**

(73) Assignee: **CHENGDU MOCUI TECHNOLOGY CO., LTD.**, Sichuan (CN)

(58) **Field of Classification Search**

None

See application file for complete search history.

(56) **References Cited**

**Reexamination Request:**

No. 90/015,232, May 23, 2023

To view the complete listing of prior art documents cited during the proceeding for Reexamination Control Number 90/015,232, please refer to the USPTO's Patent Electronic System.

**Reexamination Certificate for:**

Patent No.: **Des. 972,848**

Issued: **Dec. 20, 2022**

*Primary Examiner* — Darlington Ly

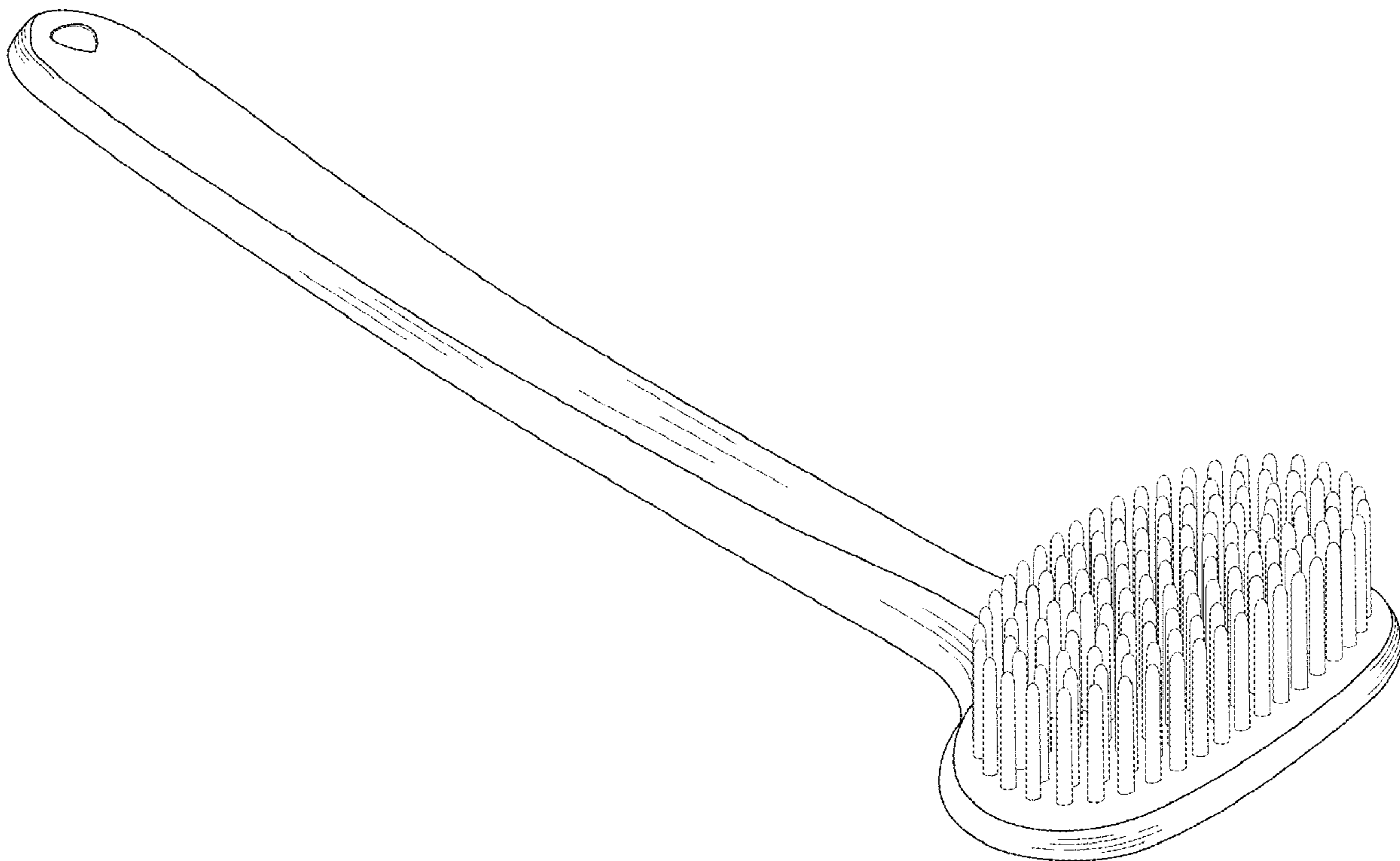

**1**  
**EX PARTE**  
**REEXAMINATION CERTIFICATE**

THE PATENT IS HEREBY AMENDED AS 5  
INDICATED BELOW.

AS A RESULT OF REEXAMINATION, IT HAS BEEN  
DETERMINED THAT:

The claim 1 is cancelled. 10

\* \* \* \* \*