



US00D972846S

(12) **United States Design Patent** (10) **Patent No.:** **US D972,846 S**
Altmann et al. (45) **Date of Patent:** **** Dec. 20, 2022**

(54) **TOOTHBRUSH HEAD**

OTHER PUBLICATIONS

(71) Applicant: **Braun GmbH**, Kronberg (DE)

All Office Actions; U.S. Appl. Nos. 29/606,819.

(72) Inventors: **Niclas Altmann**, Niddatal (DE); **Anke Renz**, Schwalbach (DE); **Bianka Becker-Salzsäuler**, Liederbach (DE); **Heidrun Schmelcher**, Oberursel (DE); **Fritz Schubert**, Bad Camberg (DE); **Ulrich Störkel**, Bad Nauheim (DE)

Primary Examiner — Cary M Robinson

(74) *Attorney, Agent, or Firm* — Vladimir Vitenberg

(57) **CLAIM**

The ornamental design for a toothbrush head, as shown and described.

(73) Assignee: **Braun GmbH**, Kronberg (DE)

DESCRIPTION

(**) Term: **15 Years**

(21) Appl. No.: **29/689,801**

(22) Filed: **May 1, 2019**

Related U.S. Application Data

(62) Division of application No. 29/606,819, filed on Jun. 7, 2017, now Pat. No. Des. 854,834.

(30) **Foreign Application Priority Data**

Oct. 7, 2016 (WO) 1039701

(51) **LOC (13) Cl.** **04-02**

(52) **U.S. Cl.**
USPC **D4/101; D4/113**

(58) **Field of Classification Search**
USPC D1/106, 199; D4/100–104, 108–111,
D4/127, 128, 132–136, 138, 199; D8/61;
(Continued)

(56) **References Cited**

U.S. PATENT DOCUMENTS

D354,168 S 1/1995 Hartwein
D476,156 S 6/2003 Ferber
(Continued)

FOREIGN PATENT DOCUMENTS

AU 201617042 S 1/2017

FIG. 1 is a perspective view of a first embodiment of a toothbrush head;
FIG. 2 is a front view thereof;
FIG. 3 is a right side view thereof;
FIG. 4 is a rear view thereof;
FIG. 5 is a left side view thereof;
FIG. 6 is a top plan view thereof;
FIG. 7 is a bottom view thereof.
FIG. 8 is a perspective view of a second embodiment of a toothbrush head;
FIG. 9 is a front view thereof;
FIG. 10 is a right side view thereof;
FIG. 11 is a rear view thereof;
FIG. 12 is a left side view thereof;
FIG. 13 is a top plan view thereof;
FIG. 14 is a bottom view thereof.
FIG. 15 is a perspective view of a third embodiment of a toothbrush head;
FIG. 16 is a front view thereof;
FIG. 17 is a right side view thereof;
FIG. 18 is a rear view thereof;
FIG. 19 is a left side view thereof;
FIG. 20 is a top plan view thereof;
FIG. 21 is a bottom view thereof.
FIG. 22 is a perspective view of a fourth embodiment of a toothbrush head;
FIG. 23 is a front view thereof;
FIG. 24 is a right side view thereof;
FIG. 25 is a rear view thereof;
FIG. 26 is a left side view thereof;

(Continued)

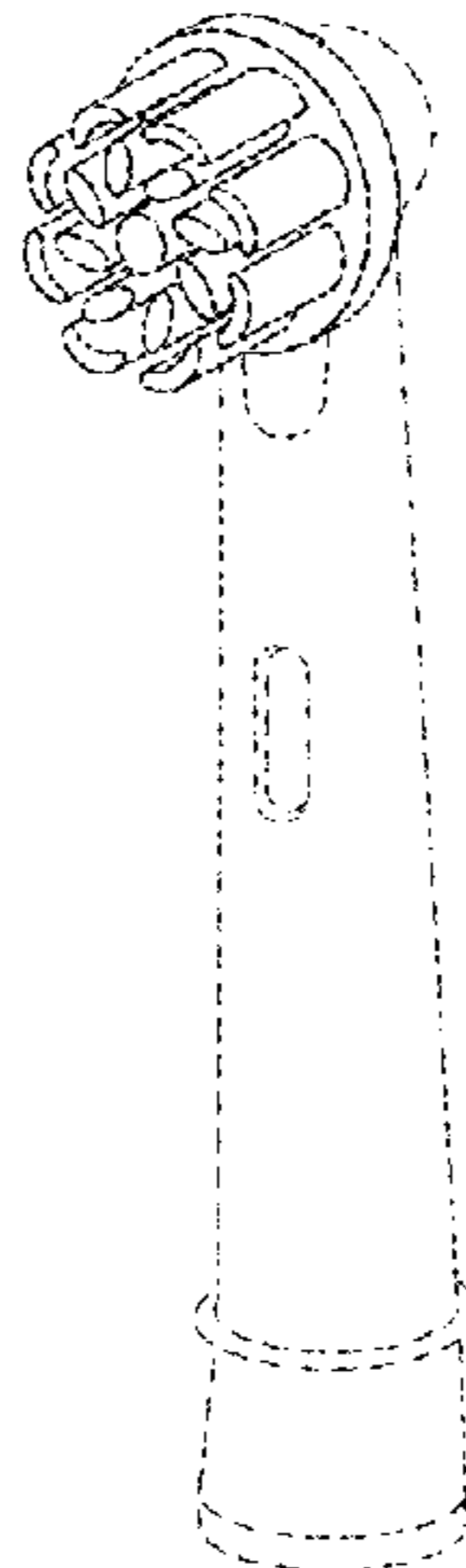

FIG. 27 is a top plan view thereof; and,
 FIG. 28 is a bottom view thereof.
 The broken lines in the drawings illustrate portions of the
 toothbrush head in which the design is embodied that form
 no part of the claimed design.

1 Claim, 4 Drawing Sheets

(58) **Field of Classification Search**

USPC D13/107, 108; D24/119, 146, 180;
 D30/158, 159
 CPC A46B 5/00; A46B 9/04; A46B 9/10; A46B
 7/00; A46B 2200/1066; A46B 2200/1073;
 A46B 2200/1086

See application file for complete search history.

(56) **References Cited**

U.S. PATENT DOCUMENTS

D480,875 S 10/2003 De
 D501,605 S 2/2005 Brown, Jr.
 D527,905 S 9/2006 Winkler
 D579,664 S 11/2008 Fisher
 D611,712 S 3/2010 Stoerkel
 D612,611 S 3/2010 Brown, Jr.
 D715,057 S 10/2014 Adriaenssen
 D751,821 S 3/2016 Since

D758,079 S 6/2016 Since
 D758,080 S 6/2016 Since
 D775,469 S 1/2017 Sikora
 D781,588 S 3/2017 Lee
 D814,195 S 4/2018 Sikora
 D819,974 S 6/2018 Johansson
 D824,174 S * 7/2018 Altmann D4/101
 D831,358 S 10/2018 Altmann
 D846,881 S * 4/2019 Altmann D4/101
 D854,834 S * 7/2019 Altmann D4/101
 D863,773 S * 10/2019 Hu D4/101
 D902,600 S * 11/2020 Altmann D4/101
 D907,368 S * 1/2021 Yang D4/101
 D907,369 S * 1/2021 Yang D4/101
 D908,363 S * 1/2021 Courtney D4/104
 11,103,054 B2 * 8/2021 Altmann A46B 9/06
 D932,778 S * 10/2021 Jing D4/102
 D933,368 S * 10/2021 Albay D4/101
 D935,189 S * 11/2021 He D4/101
 D935,190 S * 11/2021 He D4/101
 D935,191 S * 11/2021 He D4/101
 11,253,055 B2 * 2/2022 Schäfer A61C 17/3436
 D950,248 S * 5/2022 Albay D4/101
 D950,249 S * 5/2022 Albay D4/101
 D952,350 S * 5/2022 Altmann D4/101
 D953,039 S * 5/2022 Altmann D4/101
 D953,744 S * 6/2022 Altmann D4/101
 11,369,462 B2 * 6/2022 Fritsch A61C 17/222
 2017/0156835 A1 * 6/2017 Schaefer A61C 17/222
 2019/0125065 A1 * 5/2019 Altmann A46B 9/04

* cited by examiner

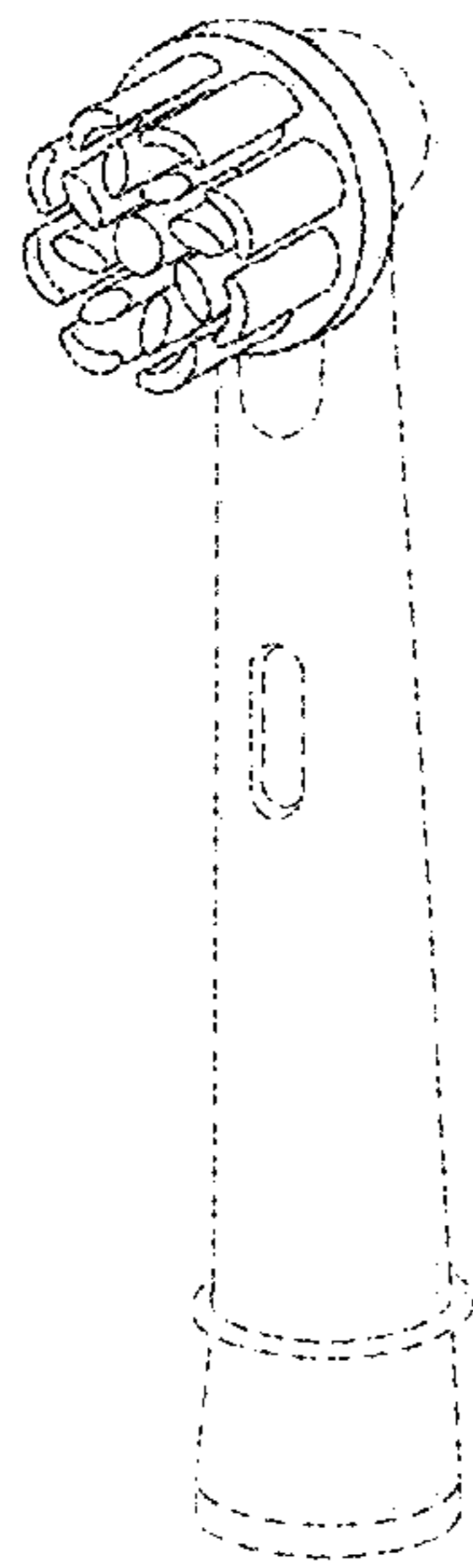

FIG. 1

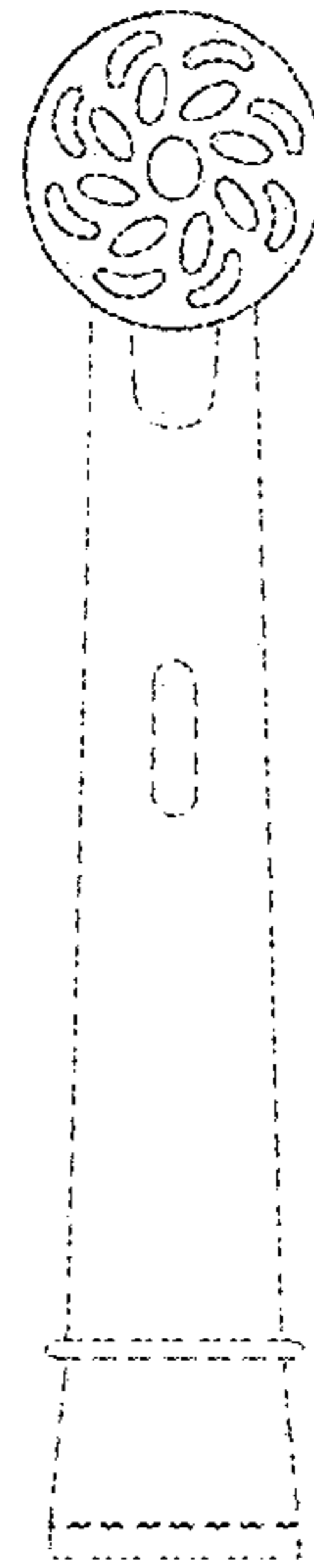

FIG. 2

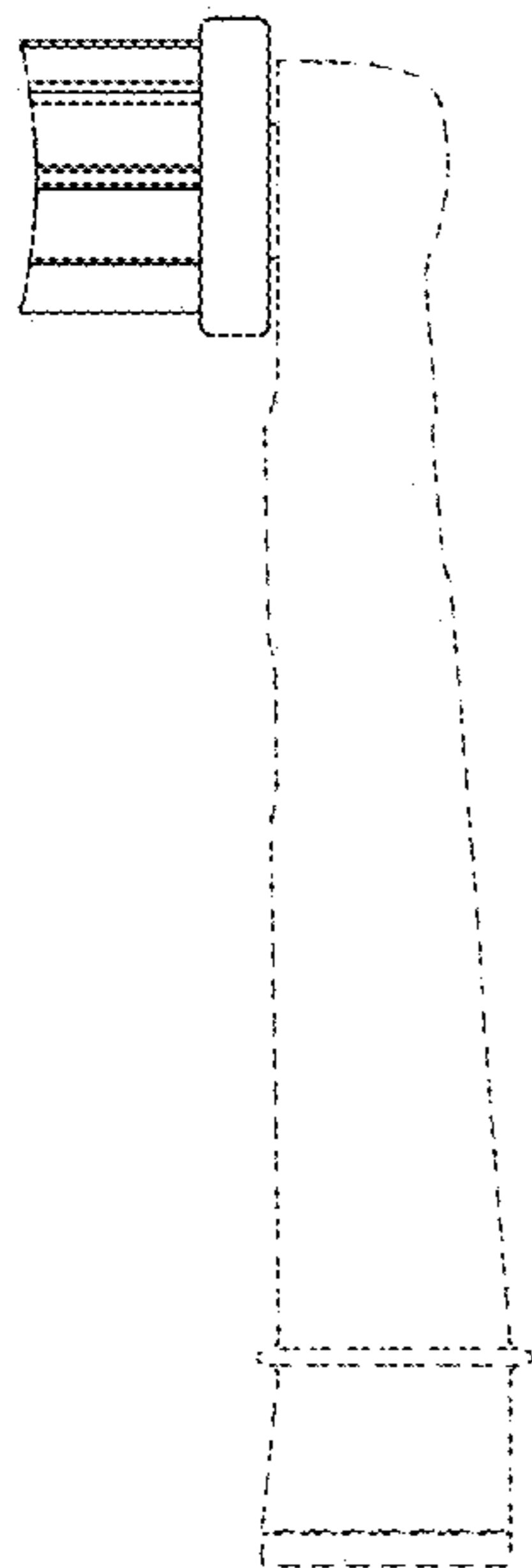

FIG. 3

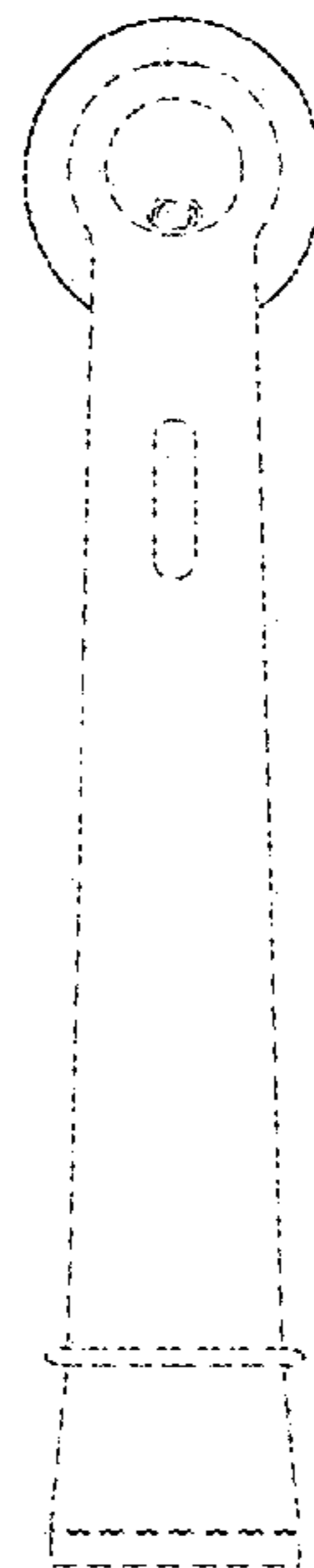

FIG. 4

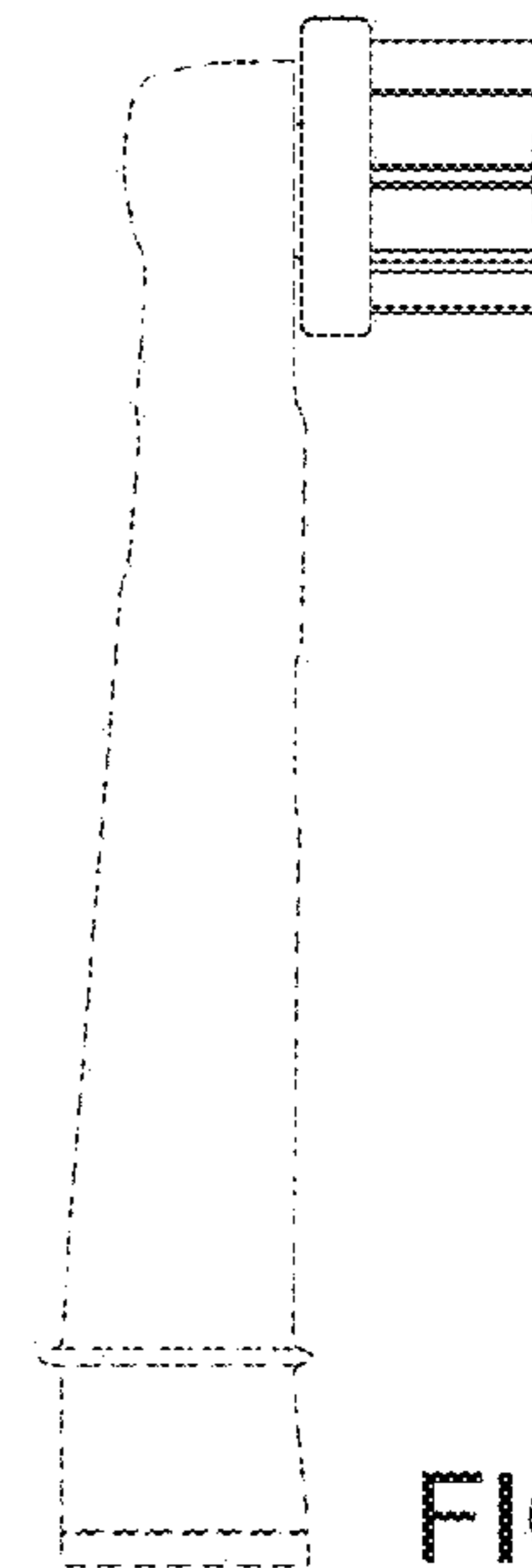

FIG. 5

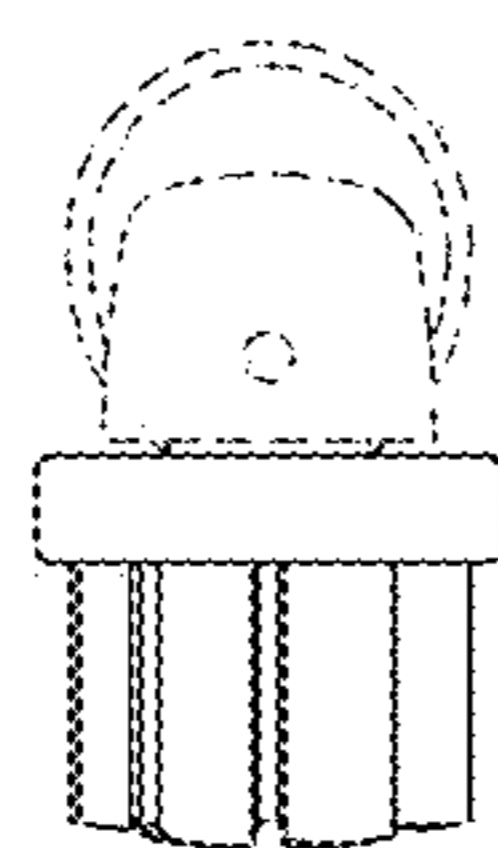

FIG. 6

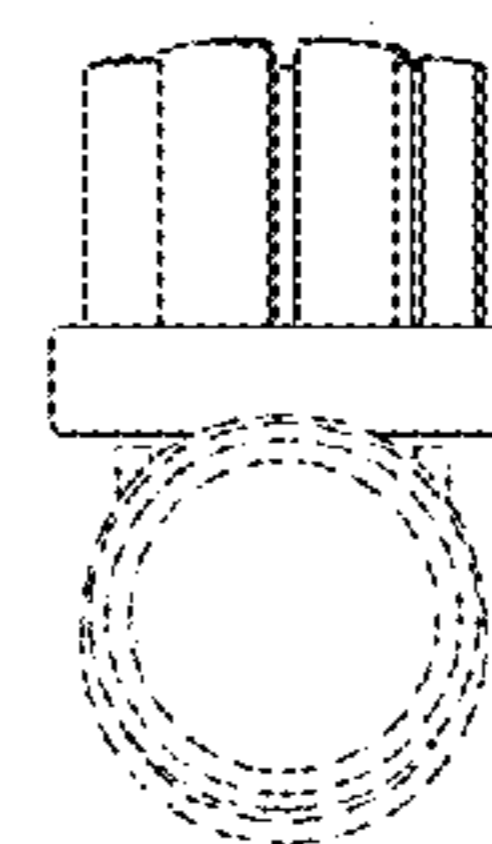

FIG. 7

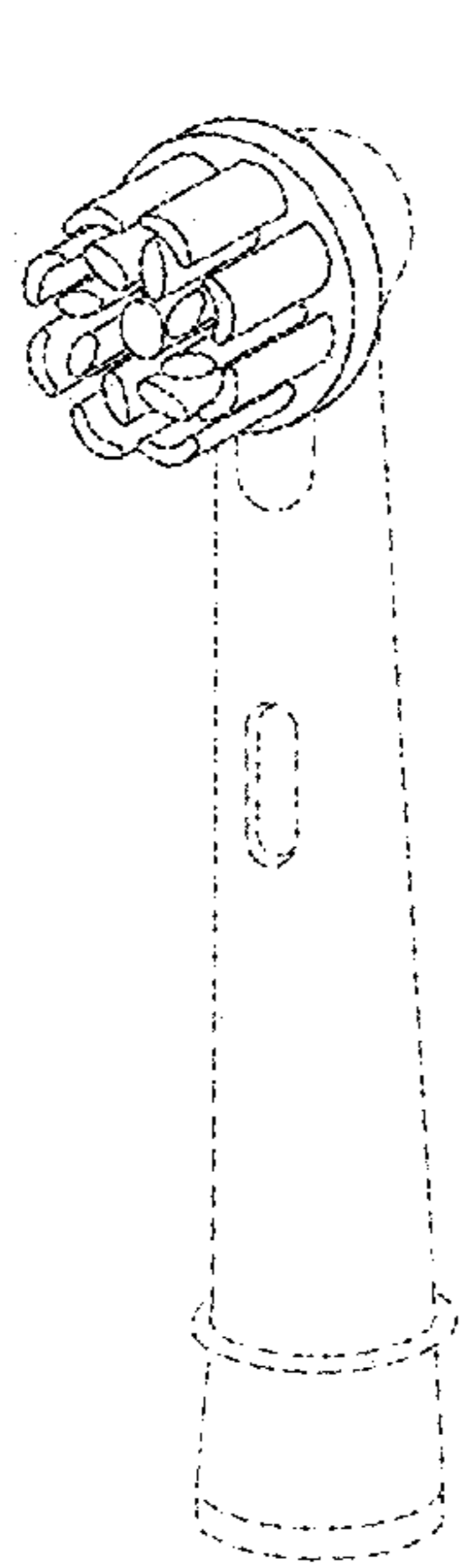

FIG. 8

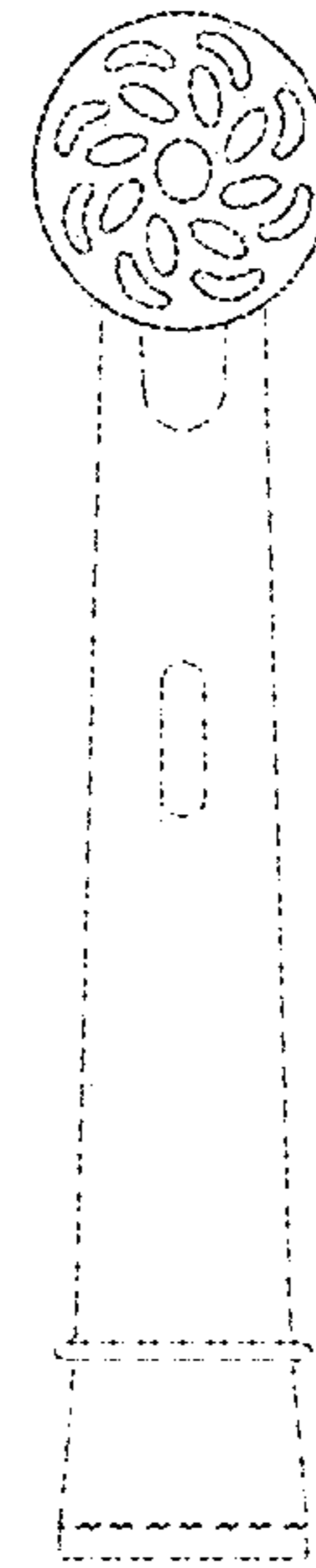

FIG. 9

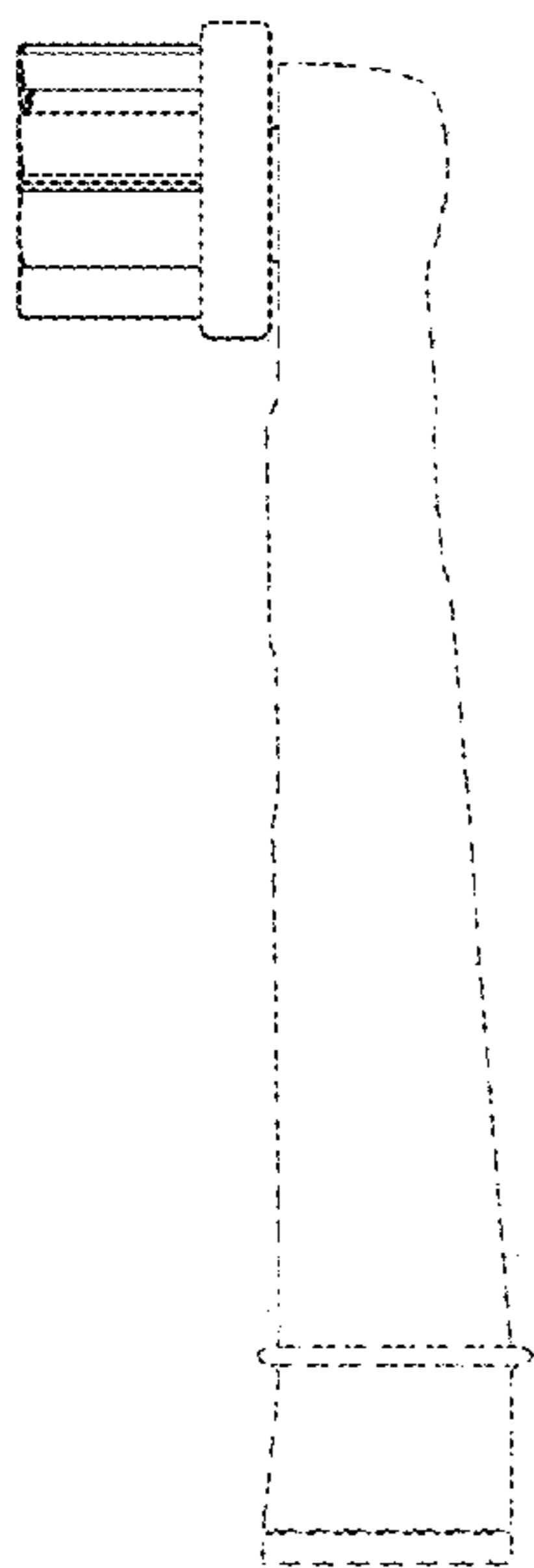

FIG. 10

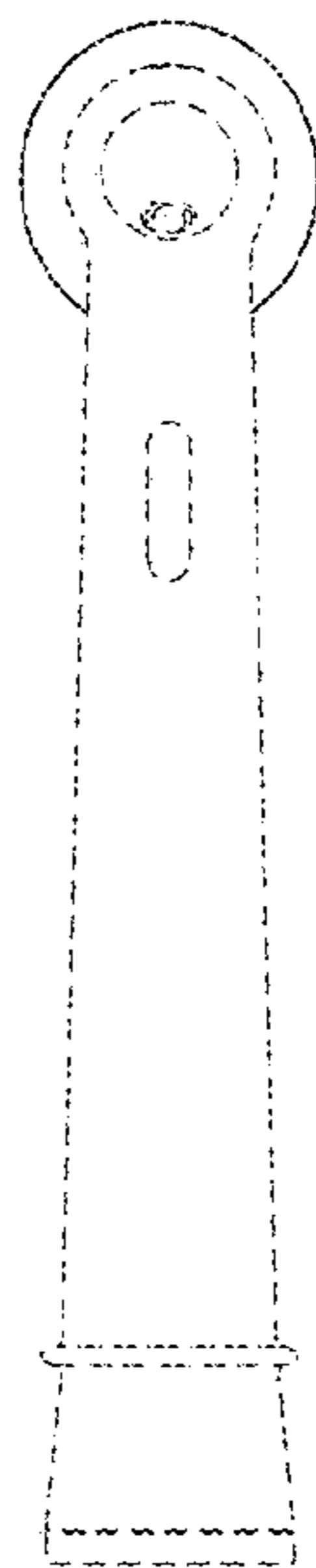

FIG. 11

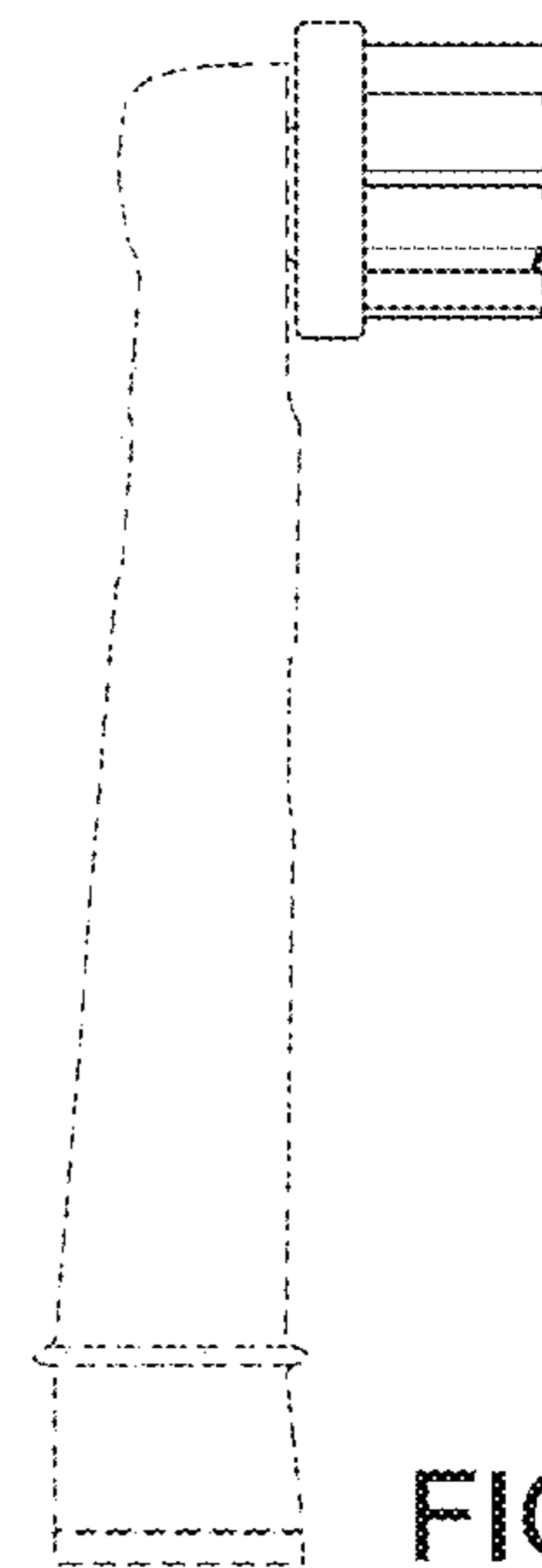

FIG. 12

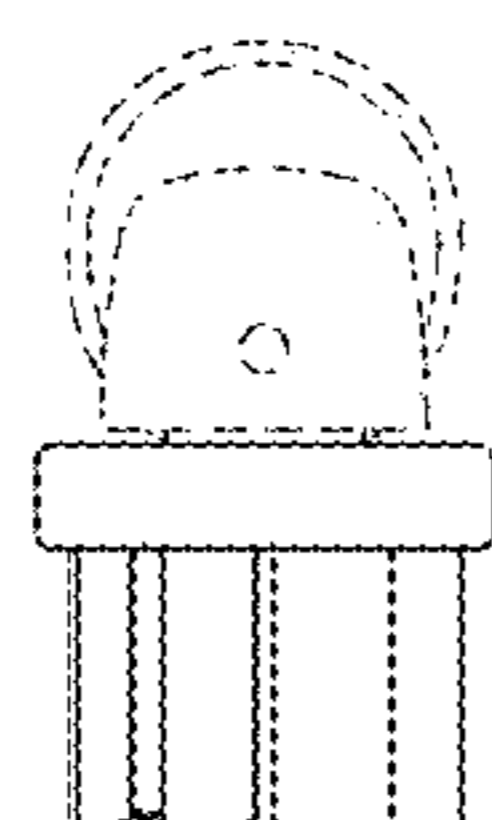

FIG. 13

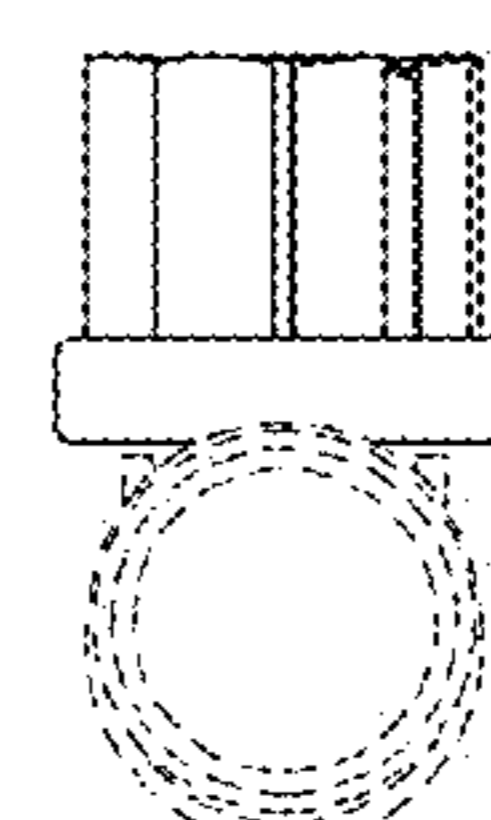

FIG. 14

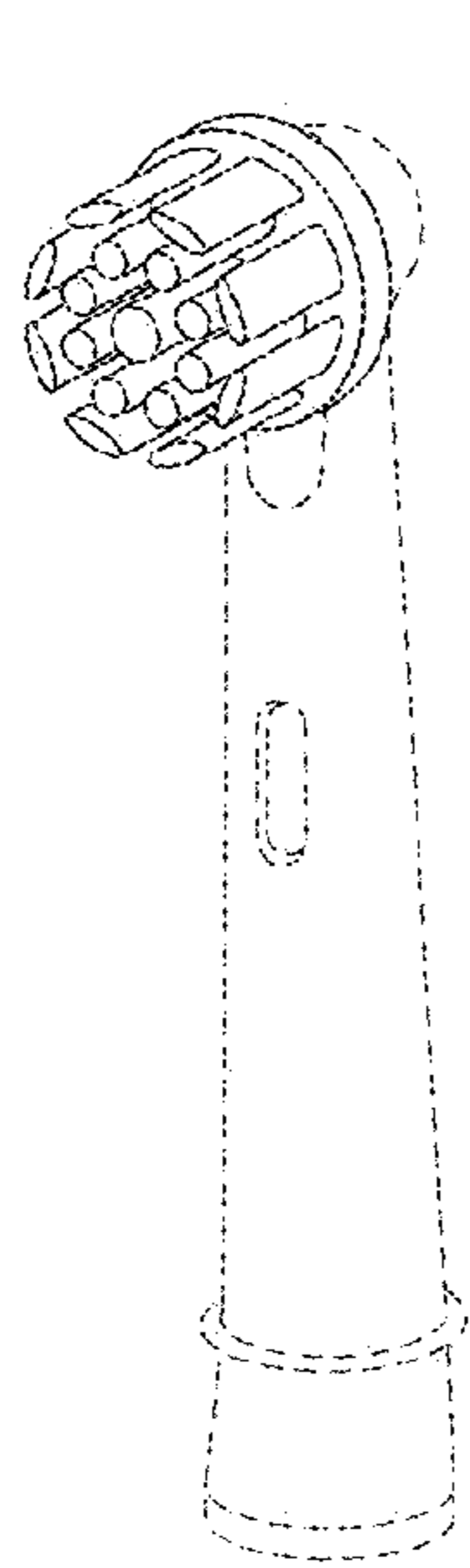

FIG. 15

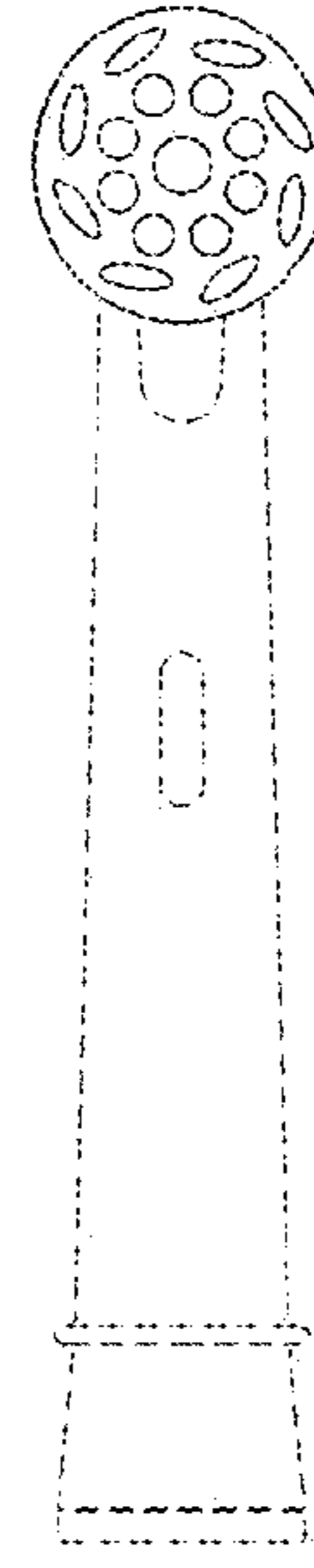

FIG. 16

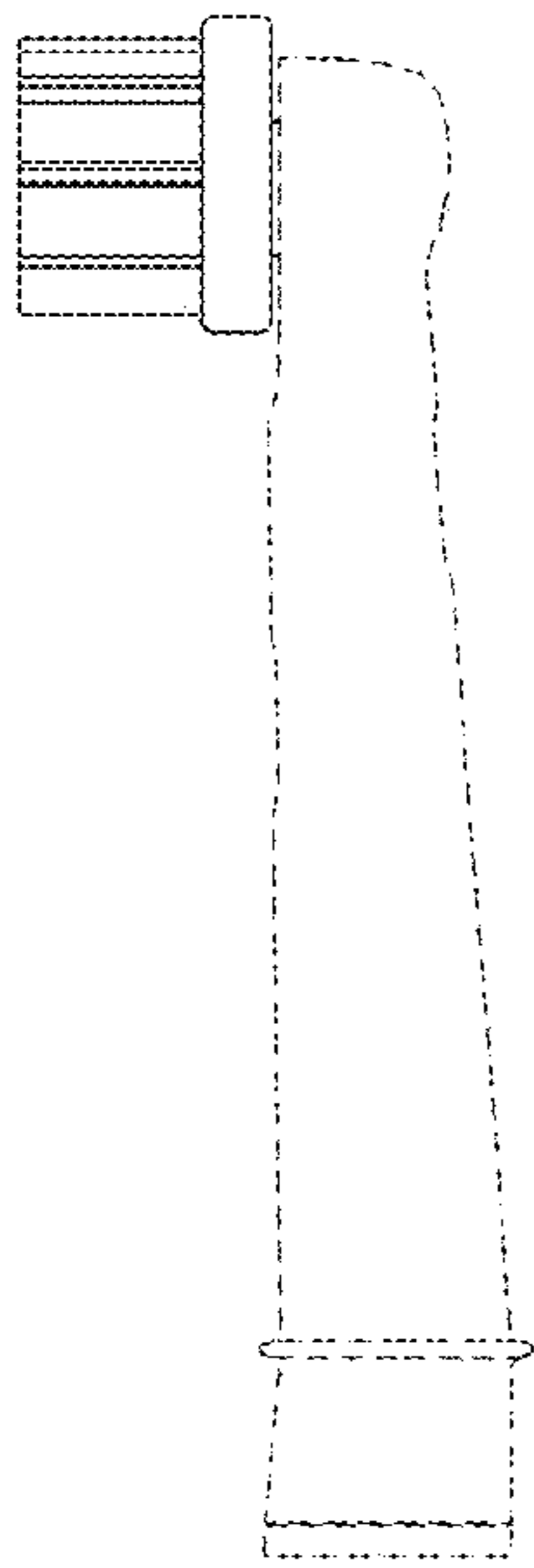

FIG. 17

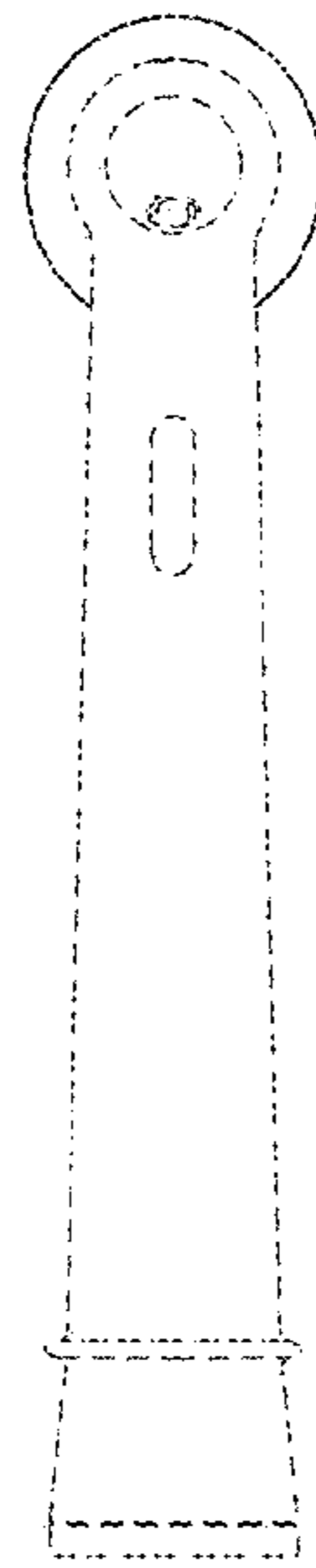

FIG. 18

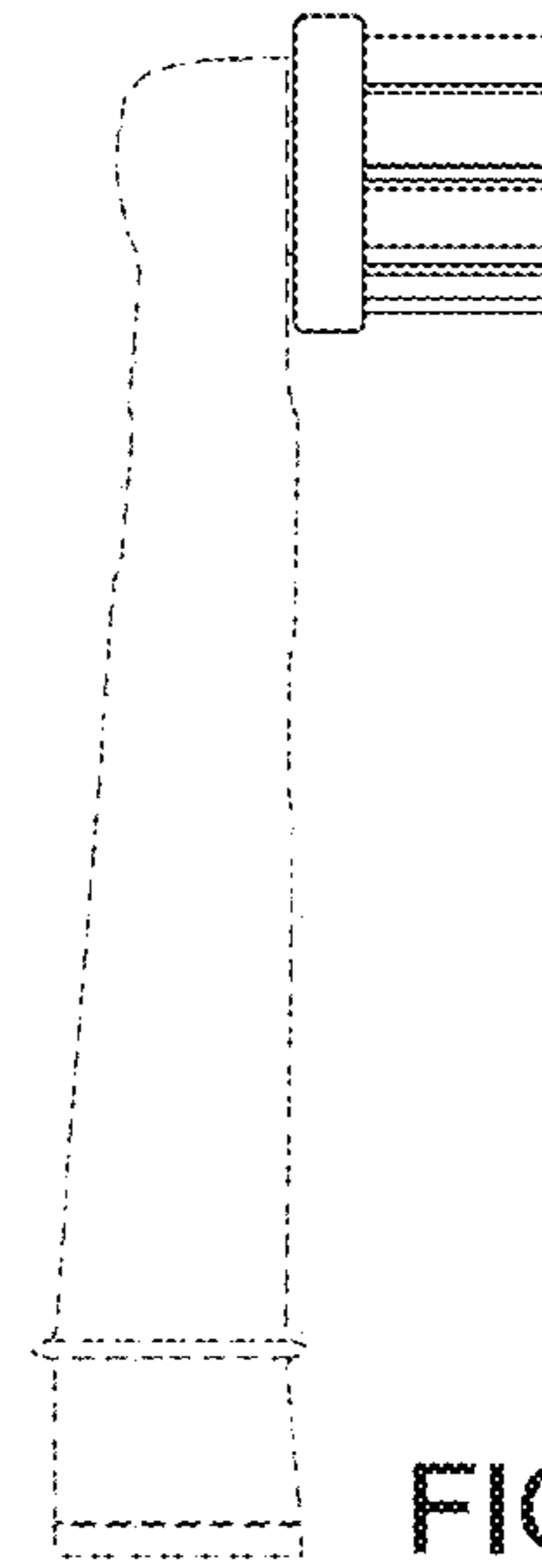

FIG. 19

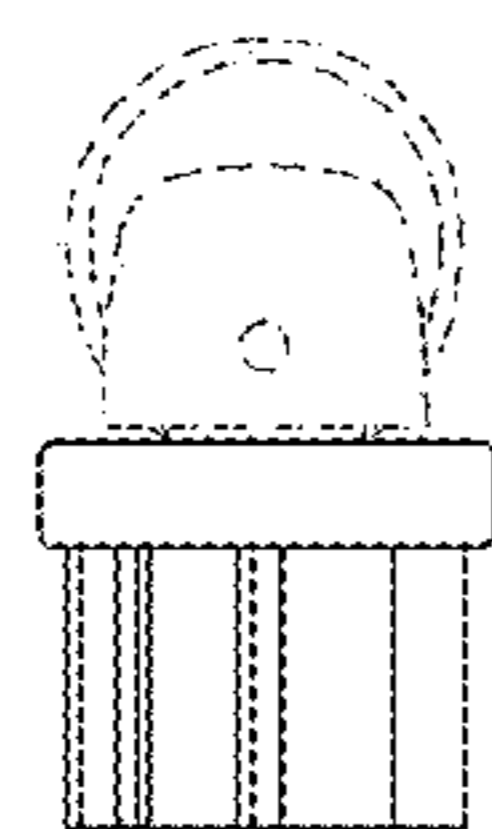

FIG. 20

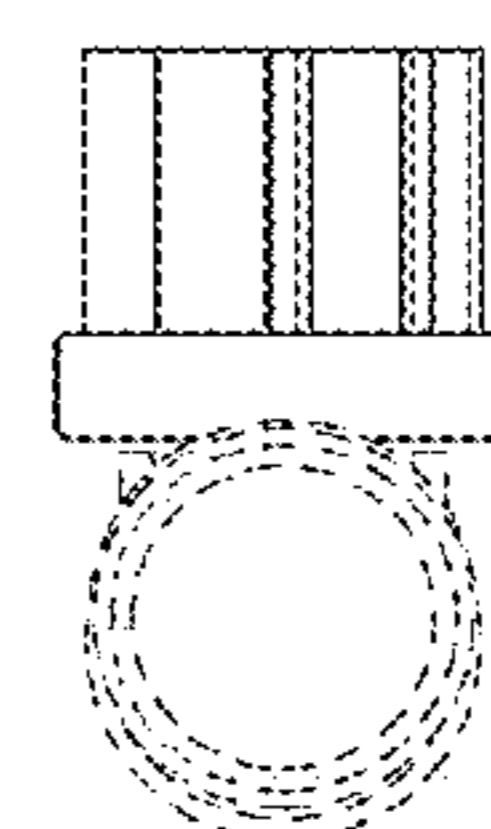

FIG. 21

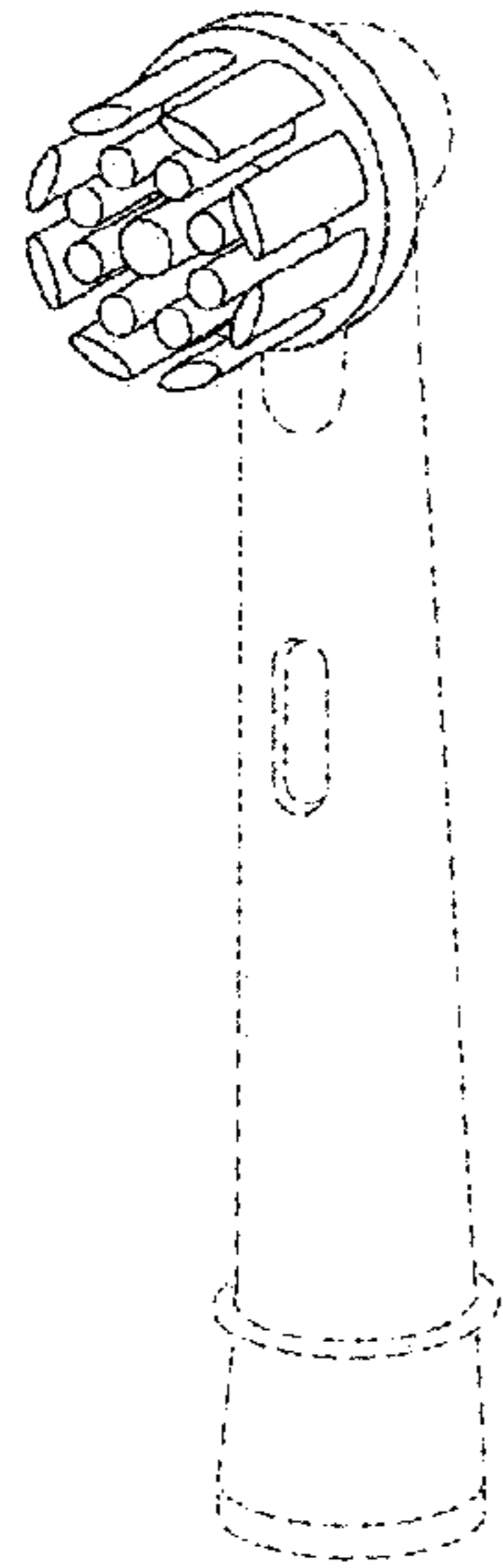

FIG. 22

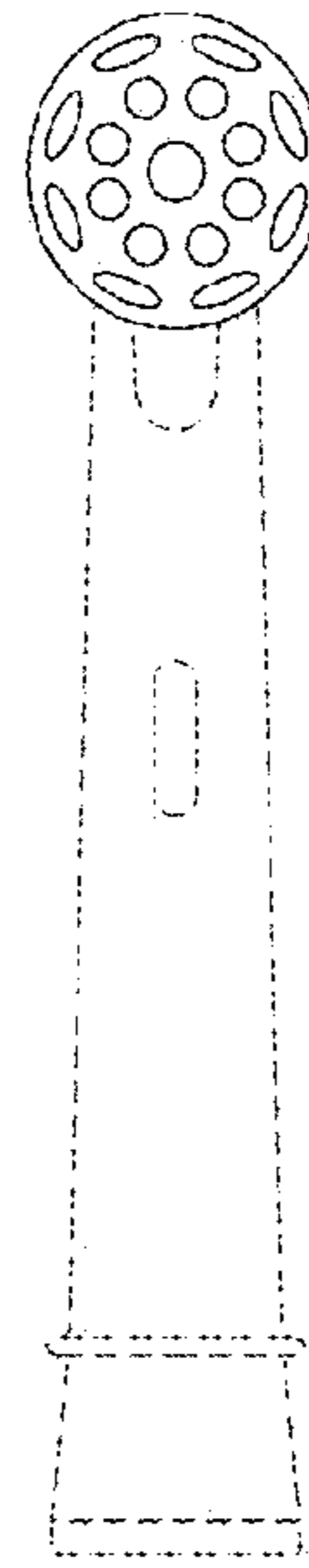

FIG. 23

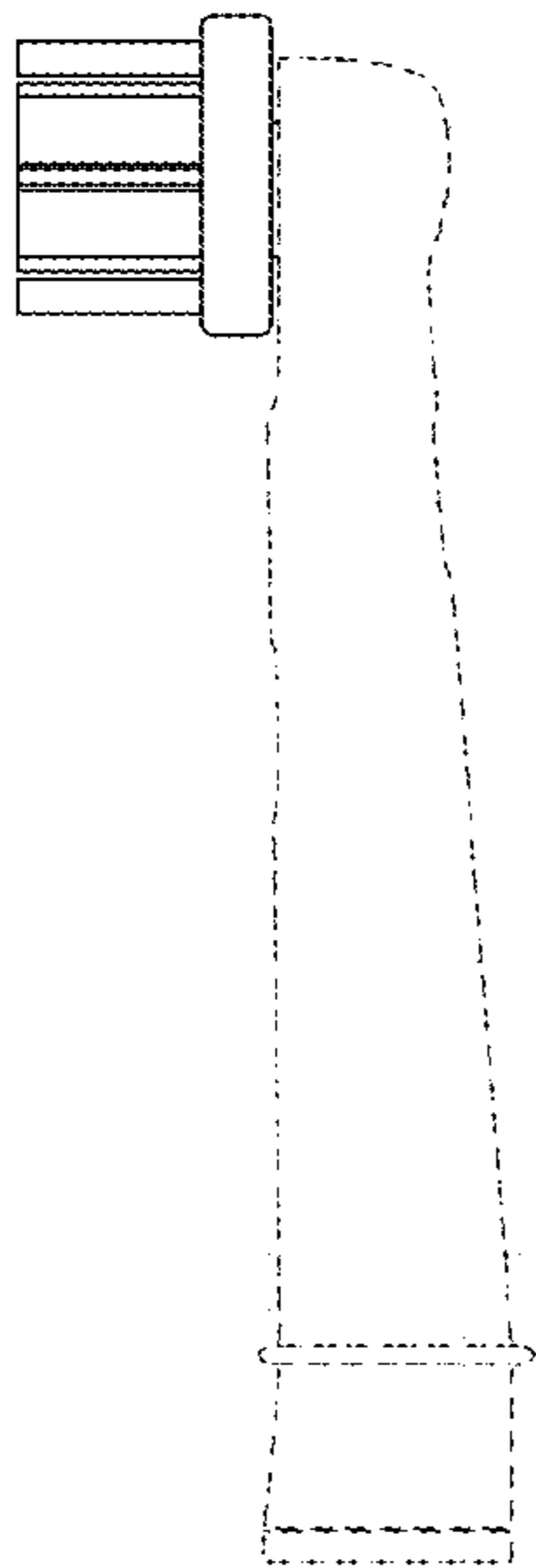

FIG. 24

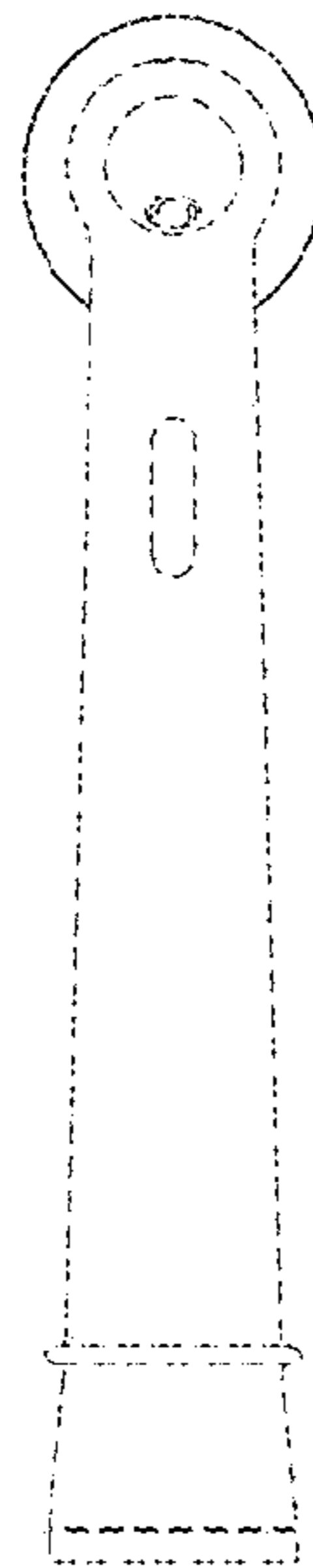

FIG. 25

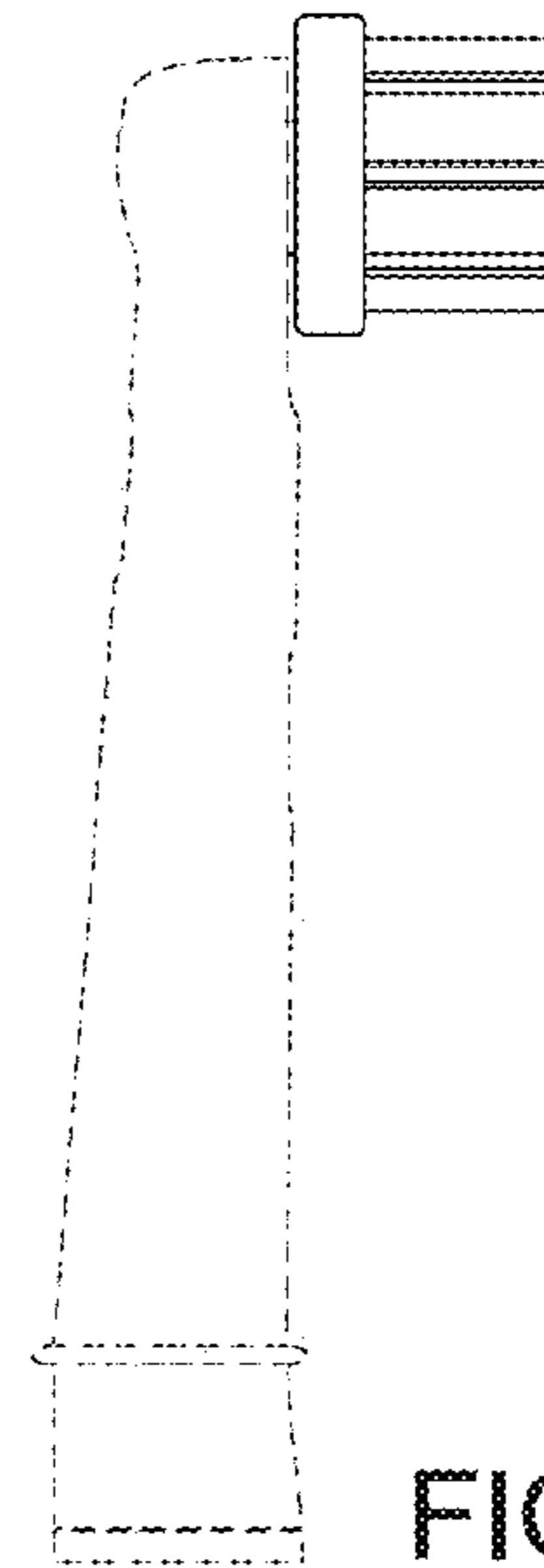

FIG. 26

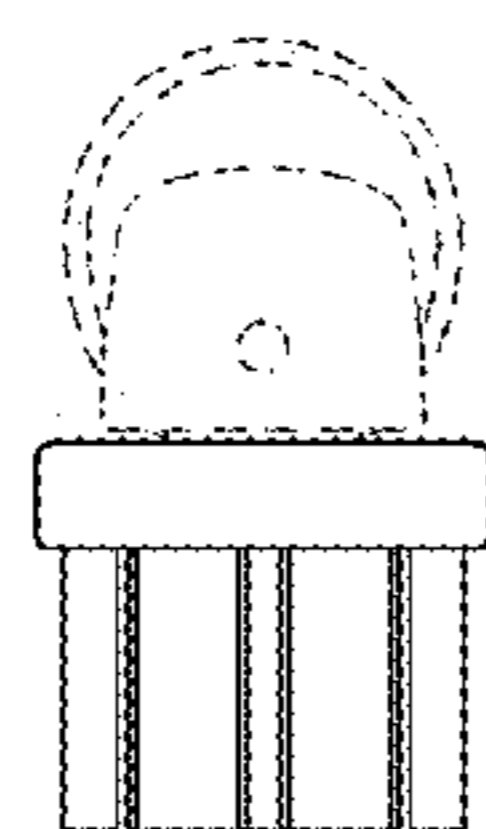

FIG. 27

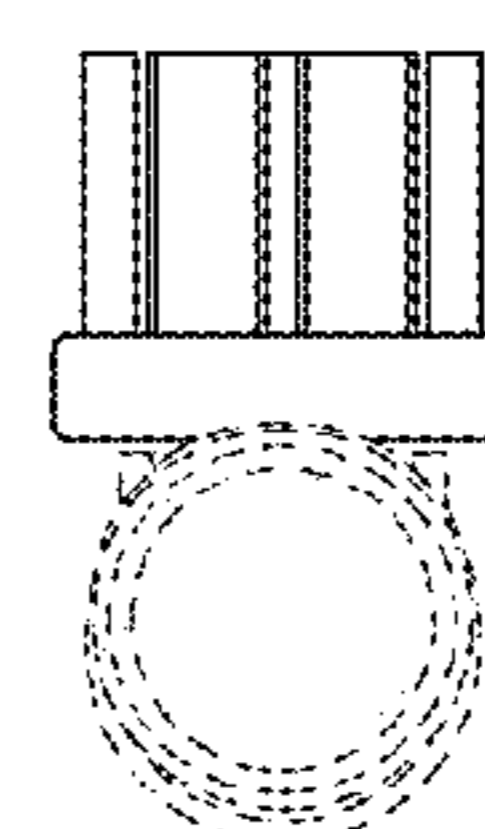

FIG. 28