



US00D972837S

(12) **United States Design Patent** (10) **Patent No.:** **US D972,837 S**
Choi (45) **Date of Patent:** **** Dec. 20, 2022**

(54) **BACKPACK**

(71) Applicant: **Aer Designs LLC**, Union City, CA (US)

(72) Inventor: **Allen Choi**, Fremont, CA (US)

(73) Assignee: **Aer Designs LLC**, Union City, CA (US)

(**) Term: **15 Years**

(21) Appl. No.: **29/773,438**

(22) Filed: **Mar. 9, 2021**

(51) **LOC (13) Cl.** **03-01**

(52) **U.S. Cl.**
USPC **D3/216**

(58) **Field of Classification Search**
USPC D3/214–226, 230–233, 242–244, 254
CPC A45F 3/00; A45F 3/005; A45F 3/02; A45F 3/04; A45F 3/042; A45F 3/047; A45F 3/06; A45F 3/08; A45F 3/10; A45F 2003/001; A45F 2003/002; A45F 2003/003; A45F 2003/006; A45F 2003/007; A45F 2003/008; A45F 2003/025; A45F 2003/045; A45F 2200/00; A45F 2200/05; A45F 2200/0525; A45F 2200/0533

See application file for complete search history.

(56) **References Cited**

U.S. PATENT DOCUMENTS

D390,352 S * 2/1998 Lane D3/216
D443,758 S * 6/2001 Stylianou D3/226
D457,307 S * 5/2002 Pukall D3/217
D457,723 S * 5/2002 Tyler D3/263
D460,614 S * 7/2002 Reimers D3/217
D463,114 S * 9/2002 Carter D3/218
D472,373 S * 4/2003 Hillman A45F 5/02
D3/218

D485,678 S * 1/2004 Haro D3/217
D511,620 S * 11/2005 Van Himbeek D3/217
D674,183 S * 1/2013 Iacchetti D3/216
D742,632 S * 11/2015 Amago D3/217
D748,910 S * 2/2016 Ford D3/217
D784,685 S * 4/2017 Newson D3/217

(Continued)

FOREIGN PATENT DOCUMENTS

CN 307038702 * 12/2021
CN 307185306 * 3/2022

(Continued)

OTHER PUBLICATIONS

Slim Pack, available at aersf.com, earliest customer review date Mar. 13, 2020 [online], site visited Apr. 27, 2022, available from the internet URL: <https://www.aersf.com/slim-pack-black> (Year: 2020).*

(Continued)

Primary Examiner — Messina L Smith
Assistant Examiner — Jillian Mazzola
(74) *Attorney, Agent, or Firm* — Kwan & Olynick LLP

(57) **CLAIM**

The ornamental design for a backpack, as shown and described.

DESCRIPTION

FIG. 1 is a rear, left, and top perspective view of a backpack showing the new design;
FIG. 2 is a rear view thereof;
FIG. 3 is a front view thereof;
FIG. 4 is a bottom view thereof;
FIG. 5 is a top view thereof;
FIG. 6 is a right view thereof; and,
FIG. 7 is a left view thereof.

The broken lines showing zipper structures depict portions of the backpack that form no part of the claimed design.

1 Claim, 3 Drawing Sheets

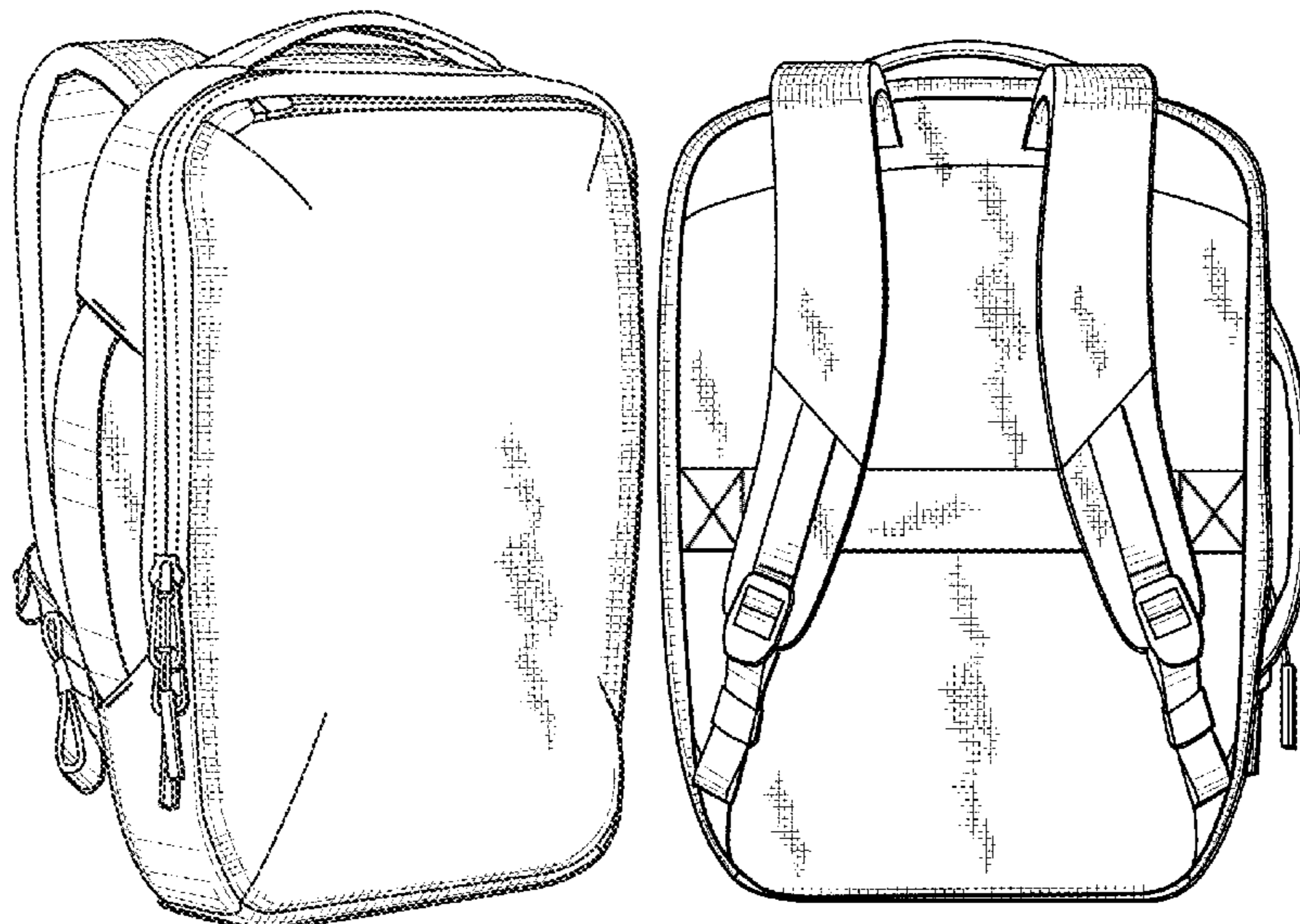

(56)

References Cited

U.S. PATENT DOCUMENTS

D789,682 S * 6/2017 Maeng D3/217
 D811,728 S * 3/2018 Sheikh D3/217
 D819,328 S * 6/2018 Muhlenkamp, IV D3/217
 D821,742 S * 7/2018 Jusic D3/217
 D828,996 S * 9/2018 Molnar D3/218
 D828,997 S * 9/2018 Lehan D3/226
 D829,436 S * 10/2018 Benzon D3/217
 D836,326 S * 12/2018 Skaff D3/217
 D847,494 S * 5/2019 Tang D3/217
 D849,399 S * 5/2019 Christophe D3/217
 D858,093 S * 9/2019 Cunha D3/217
 D860,639 S * 9/2019 Thibadeau D3/217
 D869,149 S * 12/2019 Okungbaiye D3/217
 D875,734 S * 2/2020 Collins D14/344
 D877,494 S * 3/2020 Roure D3/217
 D895,271 S * 9/2020 Enriquez D3/217
 D898,350 S * 10/2020 Peng D3/217
 D901,878 S * 11/2020 Ji D3/217
 D917,160 S * 4/2021 Guyon D3/217
 D922,062 S * 6/2021 Shi D3/217
 D925,907 S * 7/2021 Bai D3/217
 D939,206 S * 12/2021 Baires D3/217
 D946,266 S * 3/2022 Zhou D3/217
 2005/0133399 A1 * 6/2005 Fidrych A45F 3/04
 206/545

FOREIGN PATENT DOCUMENTS

JP D1700443 * 11/2021
 RU 00112231 * 11/2018

OTHER PUBLICATIONS

Aer-Slim-Pack.jpg-a, available at carryology.com, posted Mar. 8, 2020 [online], site visited Apr. 27, 2022, available from the internet URL: <https://www.carryology.com/projects/carry-giveaway/carry-giveaway-aer-work-collection-2020/attachment/aer-slim-pack-jpg-a/> (Year: 2020).*

Cotopaxi Allpa 35 L Travel Pack, available at rei.com, earliest customer review date Apr. 2019 [online], site visited Apr. 27, 2022, available from the internet URL: https://www.rei.com/product/168622/cotopaxi-allpa-35-l-travel-pack?cm_mmc=aff_AL--133155--160935--NA&avad=160935_b2849aa59 (Year: 2019).*

Arctic Hunter Multifunctional Durable Business Laptop Backpack, available at amazon.in, earliest date available Jul. 16, 2018 [online], site visited Apr. 27, 2022, available from the internet URL: <https://www.amazon.in/Arctic-Hunter-Nylon-Laptop-Backpack/dp/B07FPPYNB9> (Year: 2018).*

Maxtop Deep Storage Laptop Backpack, available at amazon.com, earliest date available Jun. 25, 2019 [online], site visited Apr. 27, 2022, available from the internet URL: <https://www.amazon.com/Backpack-Charging-Resistant-Business-Computer/dp/B07XCB51BP/> (Year: 2019).*

* cited by examiner

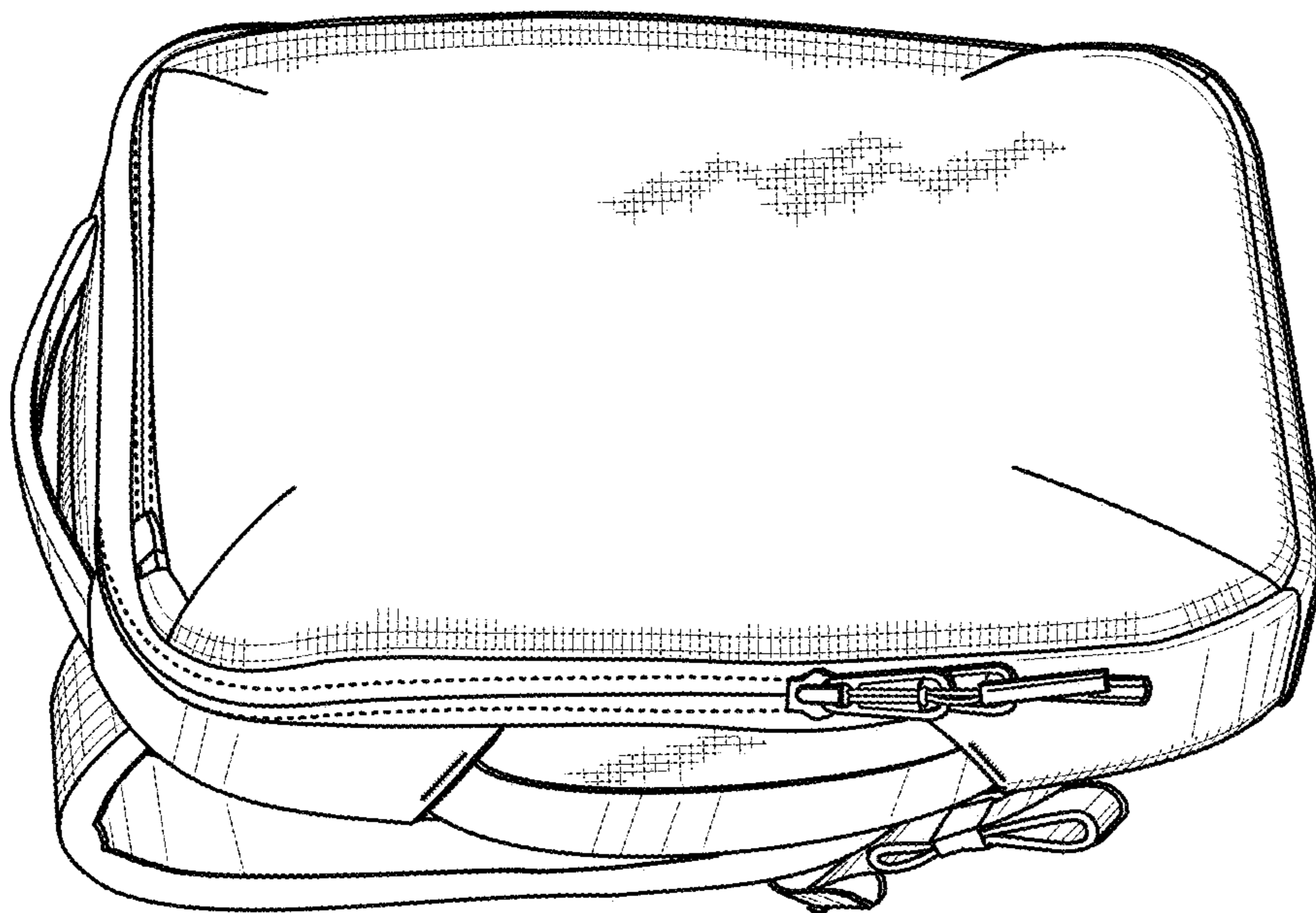

FIG. 1

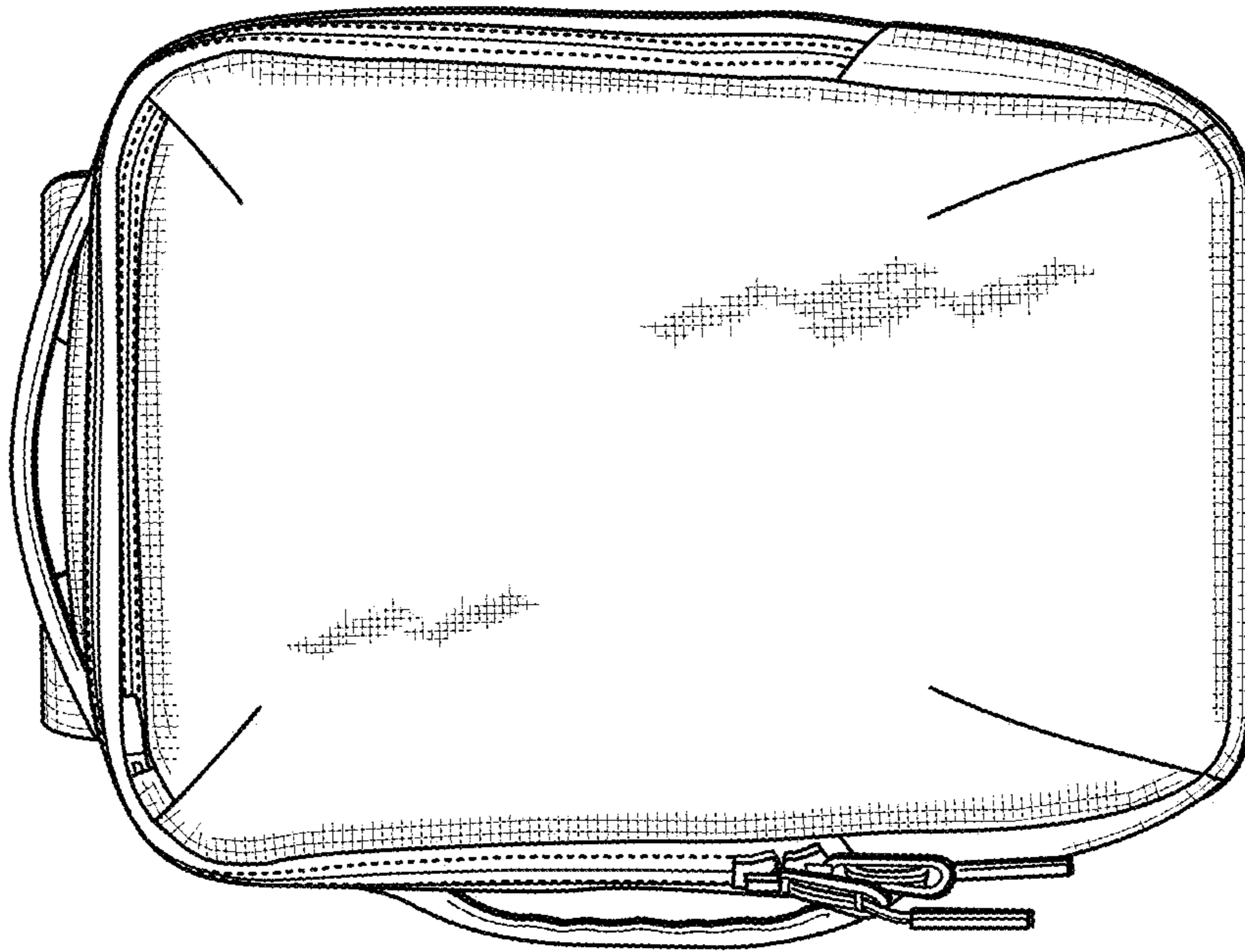

FIG. 2

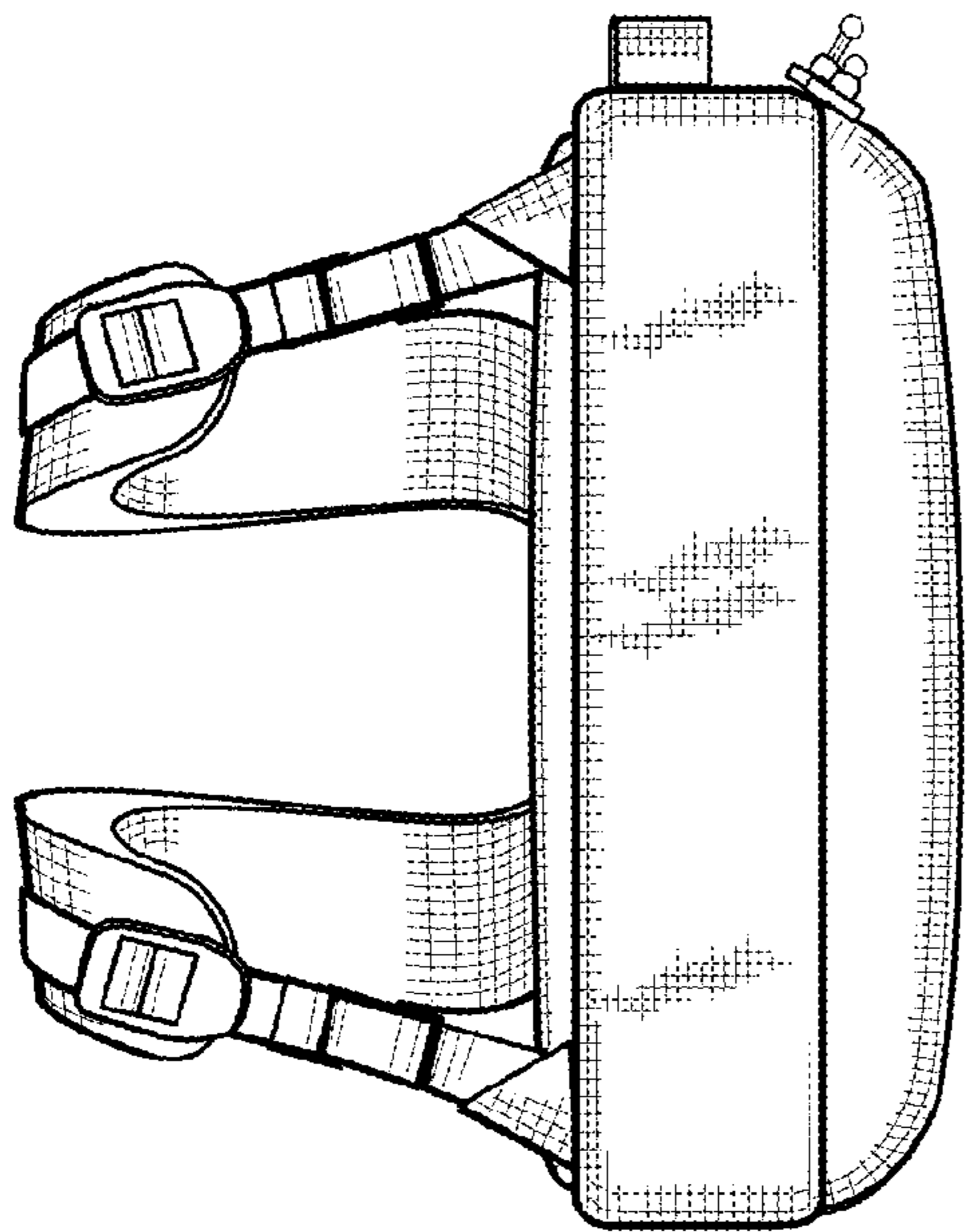

FIG. 4

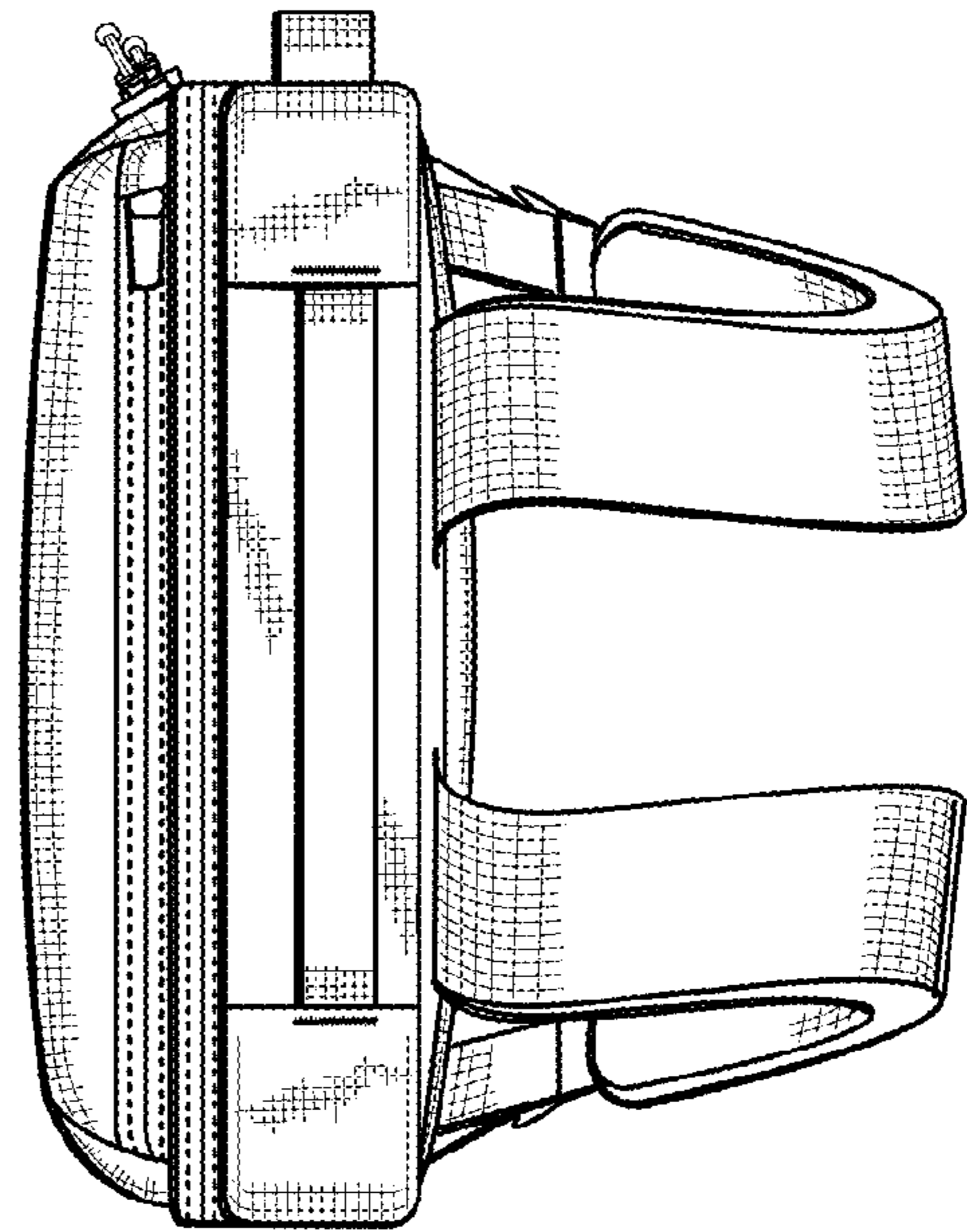

FIG. 5

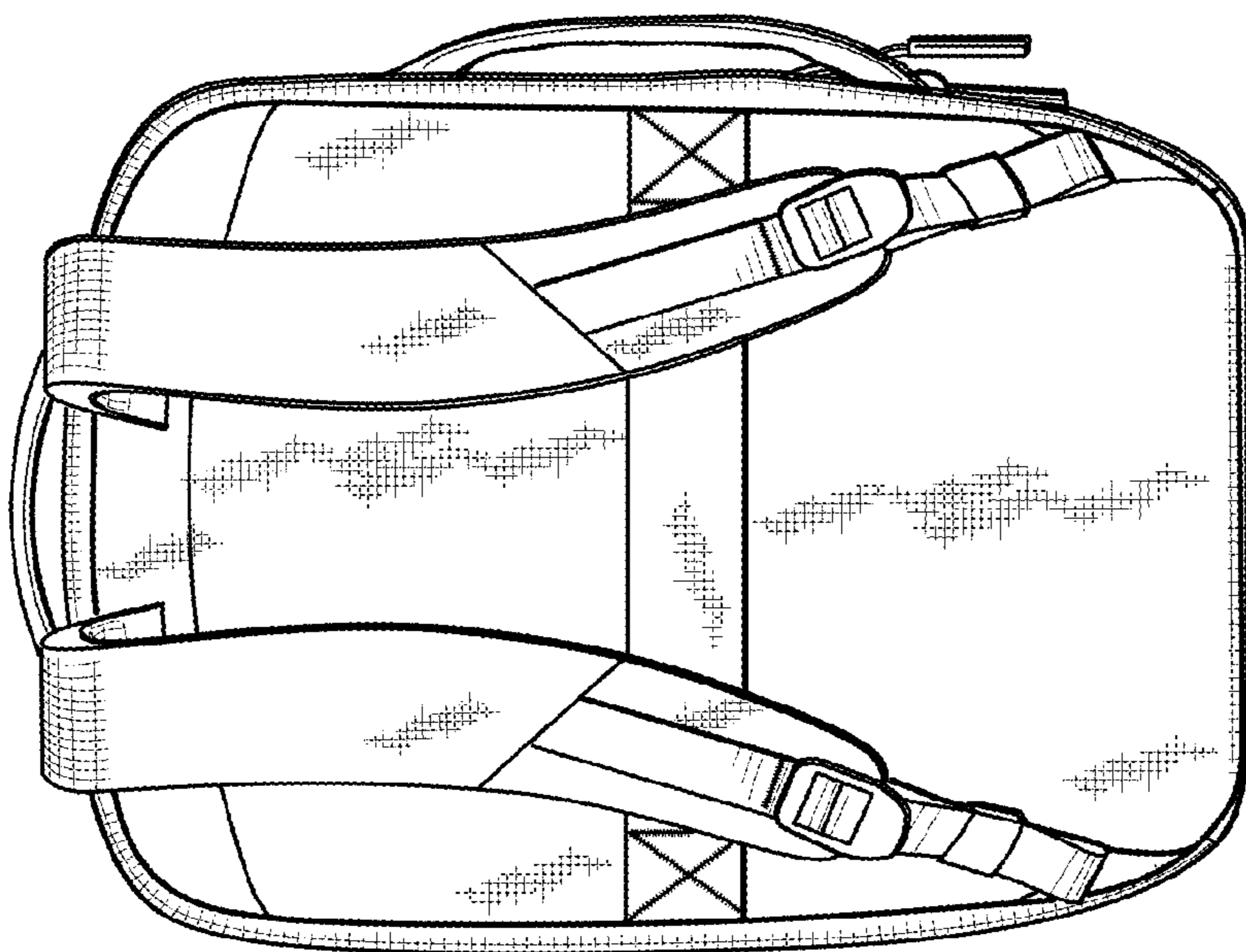

FIG. 3

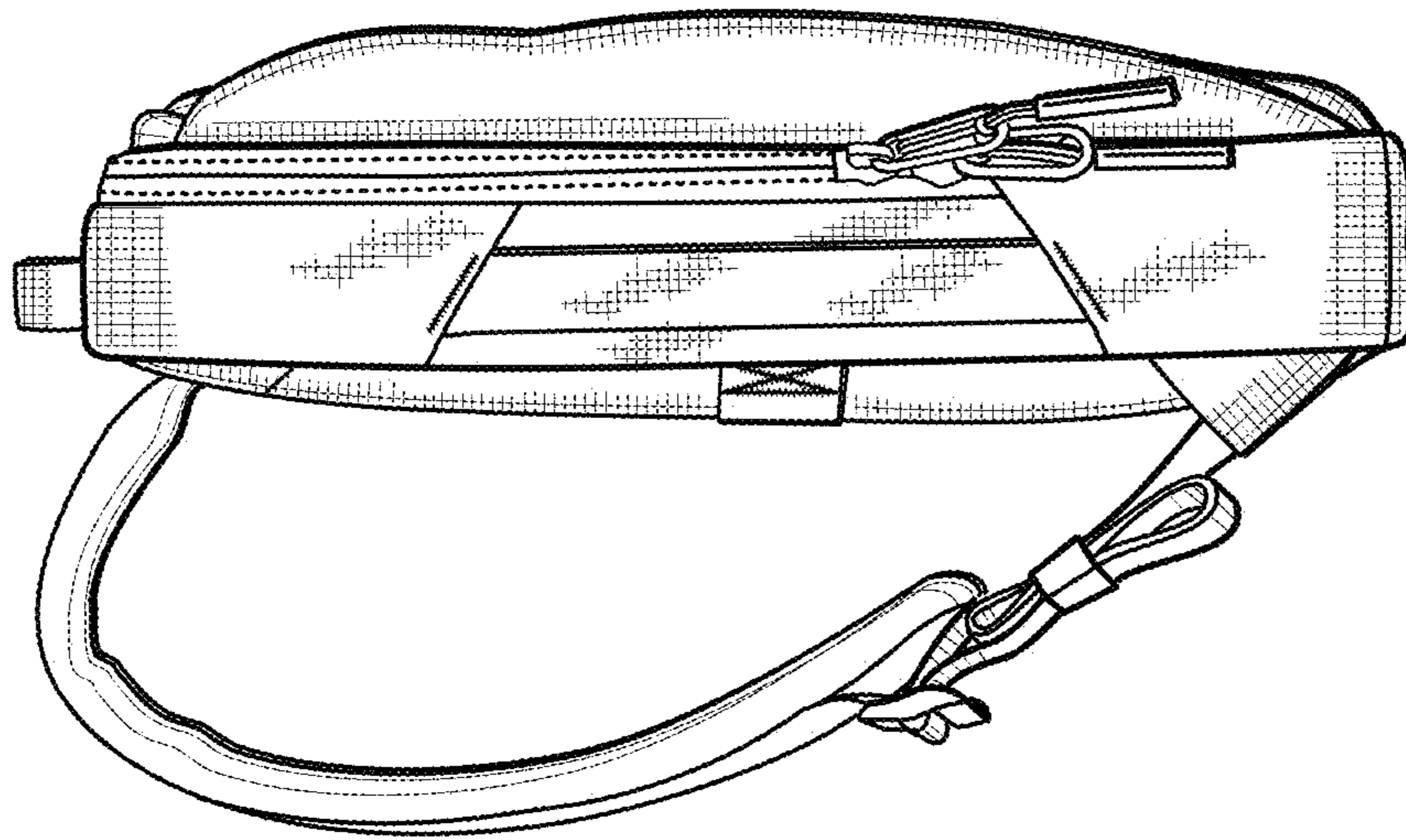

FIG. 7

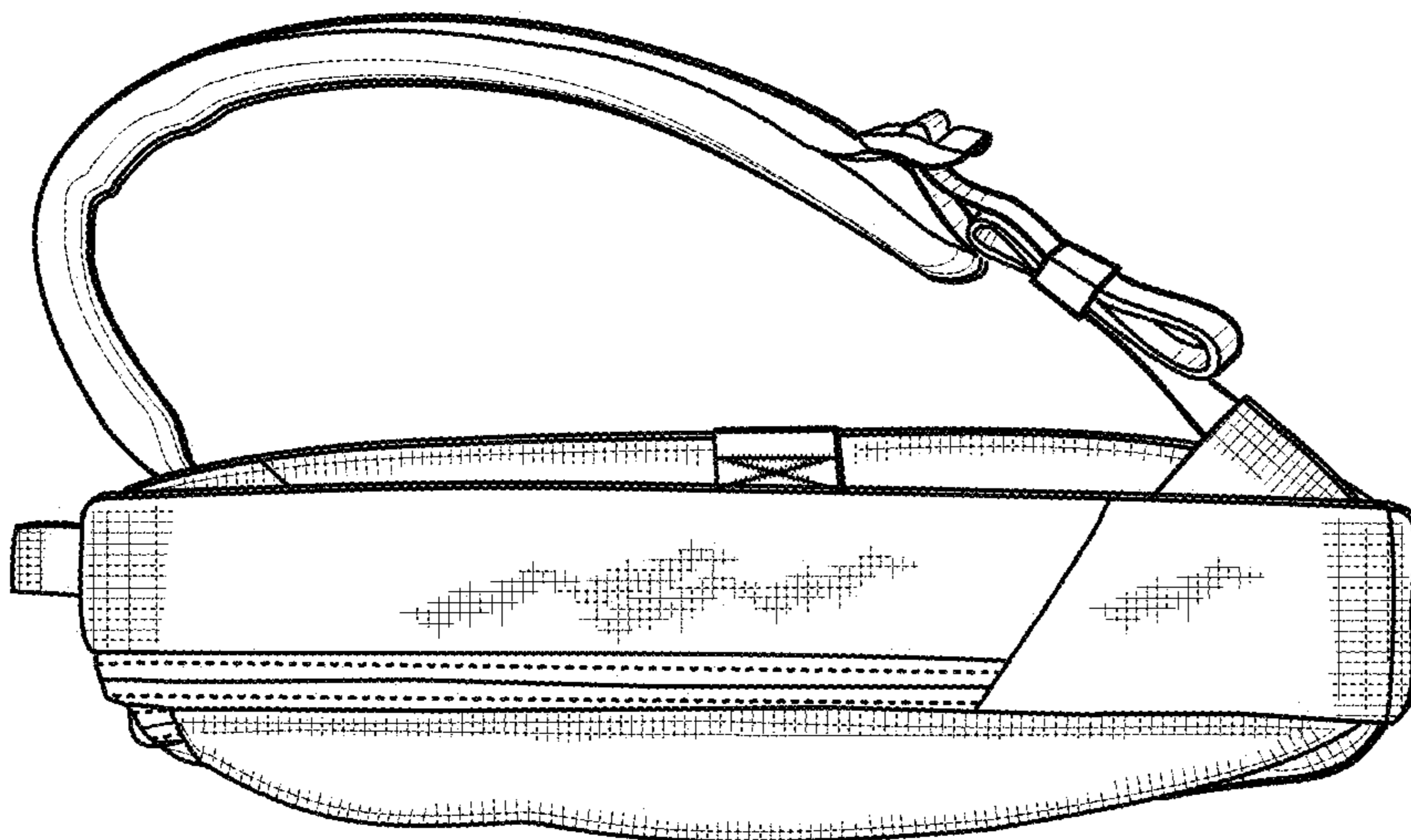

FIG. 6