



US00D972794S

(12) **United States Design Patent** (10) **Patent No.:** **US D972,794 S**
Chen (45) **Date of Patent:** **** Dec. 13, 2022**

(54) **DRYING MACHINE**

OTHER PUBLICATIONS

(71) Applicant: **Zhejiang Weibin 3D Technology Co., Ltd.**, Hangzhou (CN)

Kingkar DPF Cleaning machine operation video, announced in YouTube on May 28, 2020 [online], [site visited Apr. 20, 2022], Available from the internet URL: <https://www.youtube.com/watch?v=E7korg0q6IU> (Year: 2020).*

(72) Inventor: **Liang Chen**, Hangzhou (CN)

500W Laser Cleaning Machine For Rust And Painting Removal, announced in YouTube on Aug. 5, 2020 [online], [site visited Apr. 20, 2022], Available from the internet URL: <https://www.youtube.com/watch?v=BKxpobj6r0w> (Year: 2020).*

(**) Term: **15 Years**

* cited by examiner

(21) Appl. No.: **29/718,498**

(22) Filed: **Dec. 25, 2019**

(51) **LOC (13) Cl.** **15-05**

(52) **U.S. Cl.**
USPC **D32/1**

(58) **Field of Classification Search**

USPC D32/1, 5, 8, 15, 21; D15/122, 199
CPC .. B08B 3/12; B08B 5/00; B08B 7/005; B08B 7/026; B08B 7/0057; B08B 2209/005; F26B 9/06; F26B 21/14; F26B 25/16

See application file for complete search history.

Primary Examiner — Jennifer Rivard

Assistant Examiner — Jennylou M Binas

(74) *Attorney, Agent, or Firm* — Rumit R. Kanakia

(57) **CLAIM**

The ornamental design for a drying machine, as shown and described.

(56) **References Cited**

U.S. PATENT DOCUMENTS

D201,633 S *	7/1965	Little	D32/8
D233,252 S *	10/1974	Utzinger	D10/91
D287,655 S *	1/1987	Schmitz	D32/15
D307,654 S *	5/1990	Weirsman	D32/1
D433,147 S *	10/2000	Florkey	D24/217
D560,952 S *	2/2008	Lee	D7/323
D682,490 S *	5/2013	Goetzke	D32/1
D683,503 S *	5/2013	Helm	D32/1
D688,839 S *	8/2013	Helm	D32/1
D862,814 S *	10/2019	Chang	D32/1
D922,605 S *	6/2021	Berkeley	D24/217

FOREIGN PATENT DOCUMENTS

CN	305545877	*	1/2020
CN	307244810	*	4/2022
CN	307267016	*	4/2022

DESCRIPTION

FIG. 1 is a first perspective view of a drying machine showing my new design;
FIG. 2 is a second perspective view thereof;
FIG. 3 is a front view thereof;
FIG. 4 is a back view thereof;
FIG. 5 is a left side view thereof;
FIG. 6 is a right side view thereof;
FIG. 7 is a top view thereof; and,
FIG. 8 is a bottom view thereof.
The broken lines shown in the drawings depict portions of the drying machine that form no part of the claimed design.

1 Claim, 8 Drawing Sheets

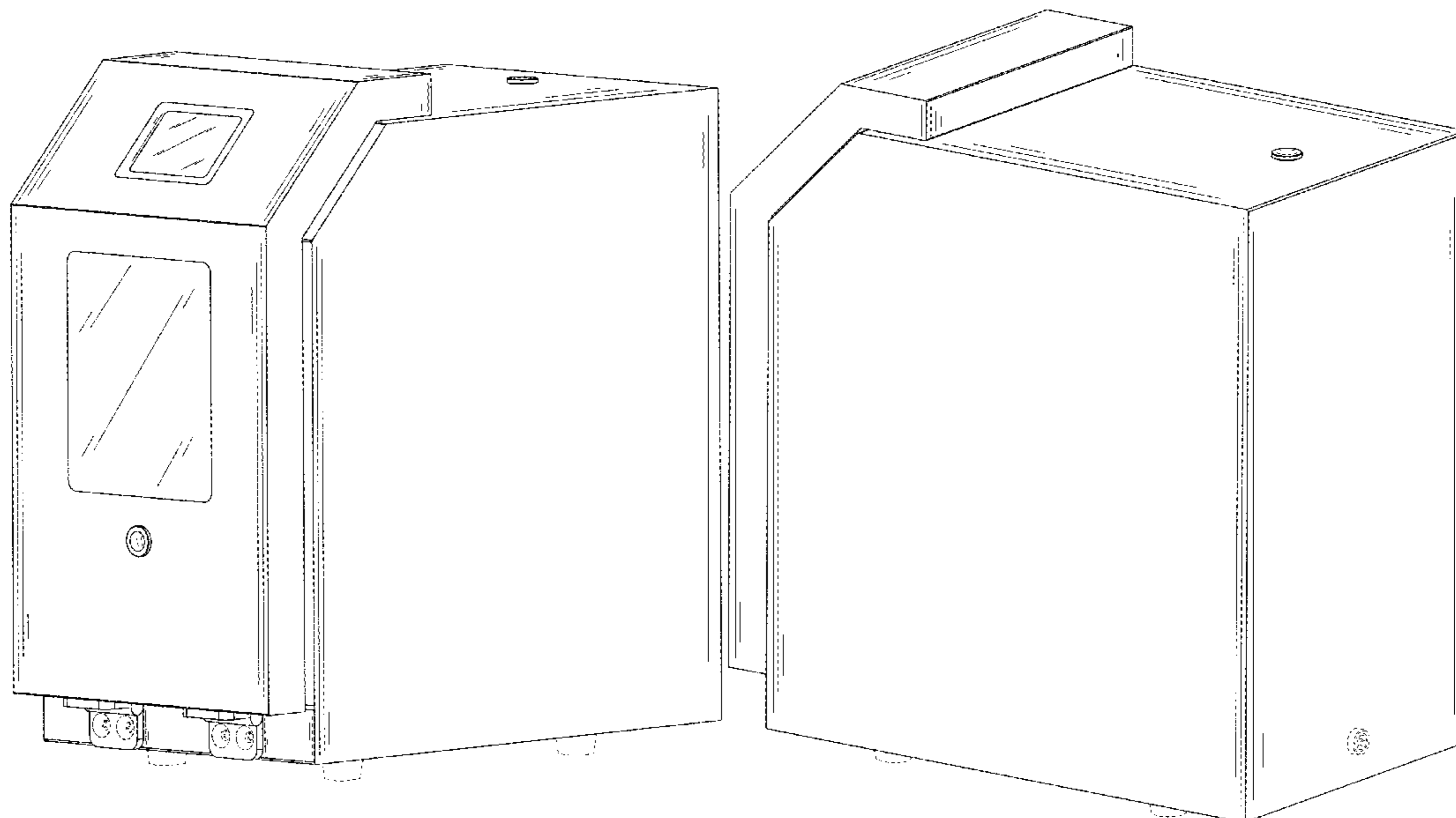

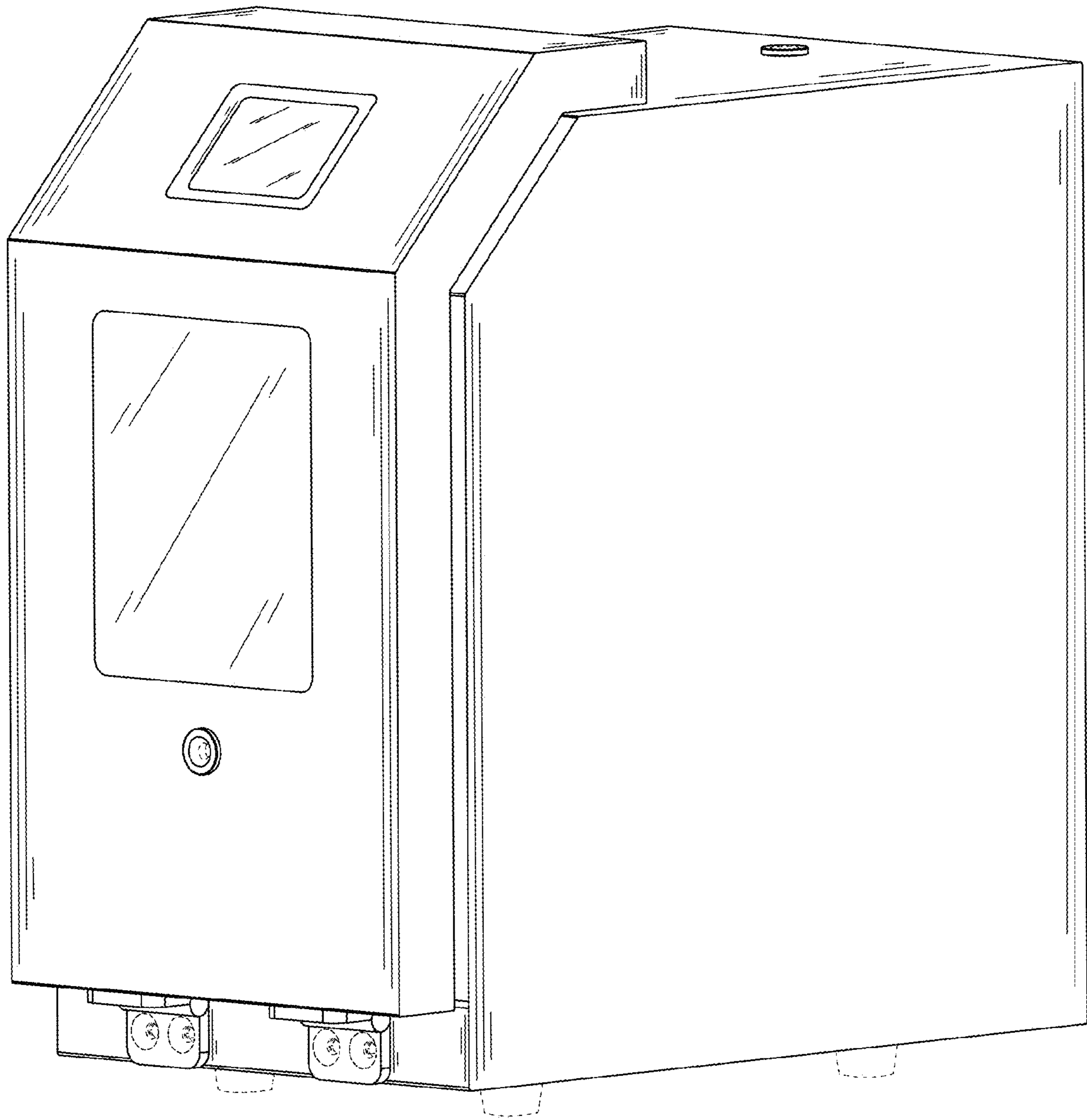

FIG. 1

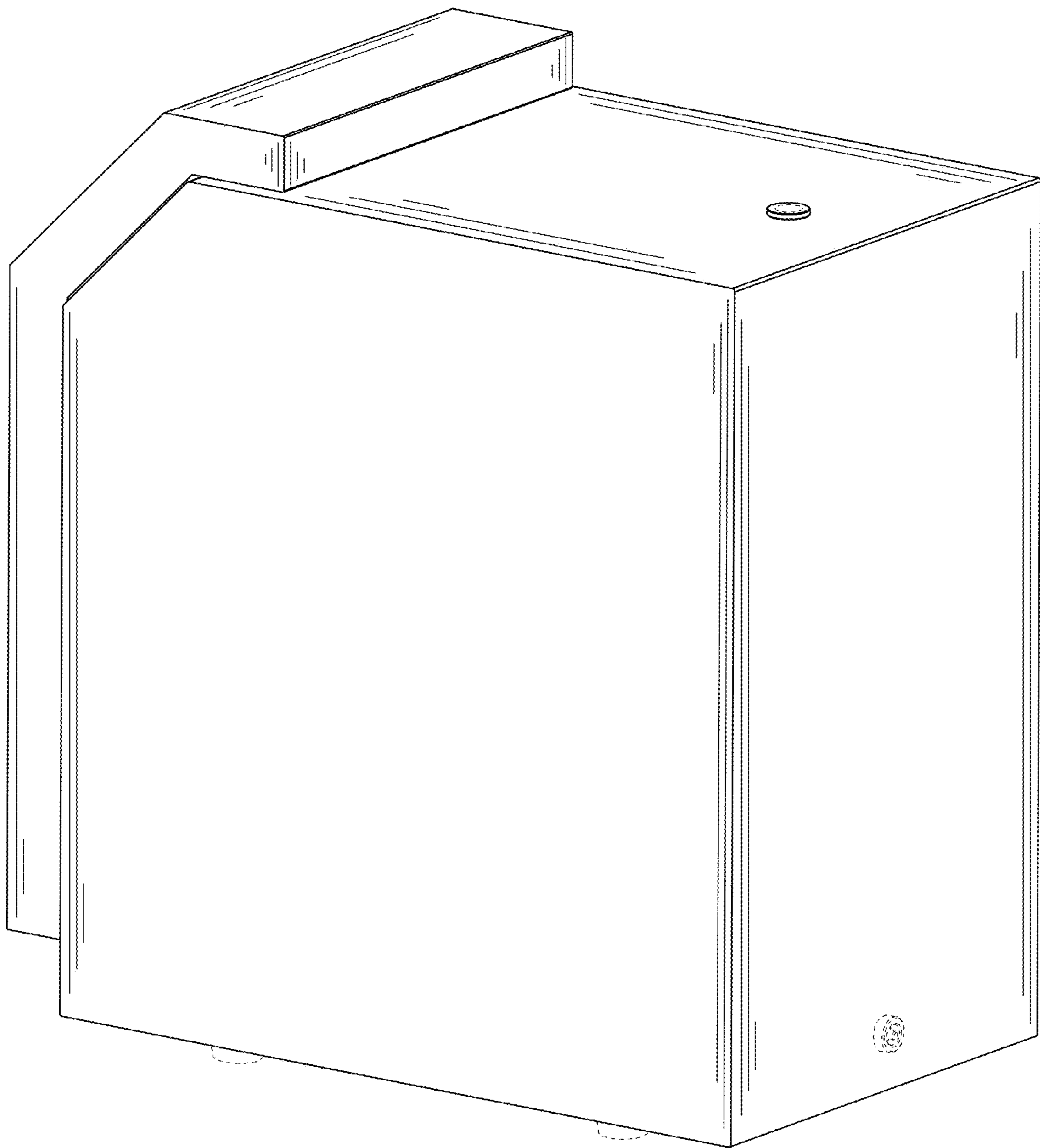

FIG. 2

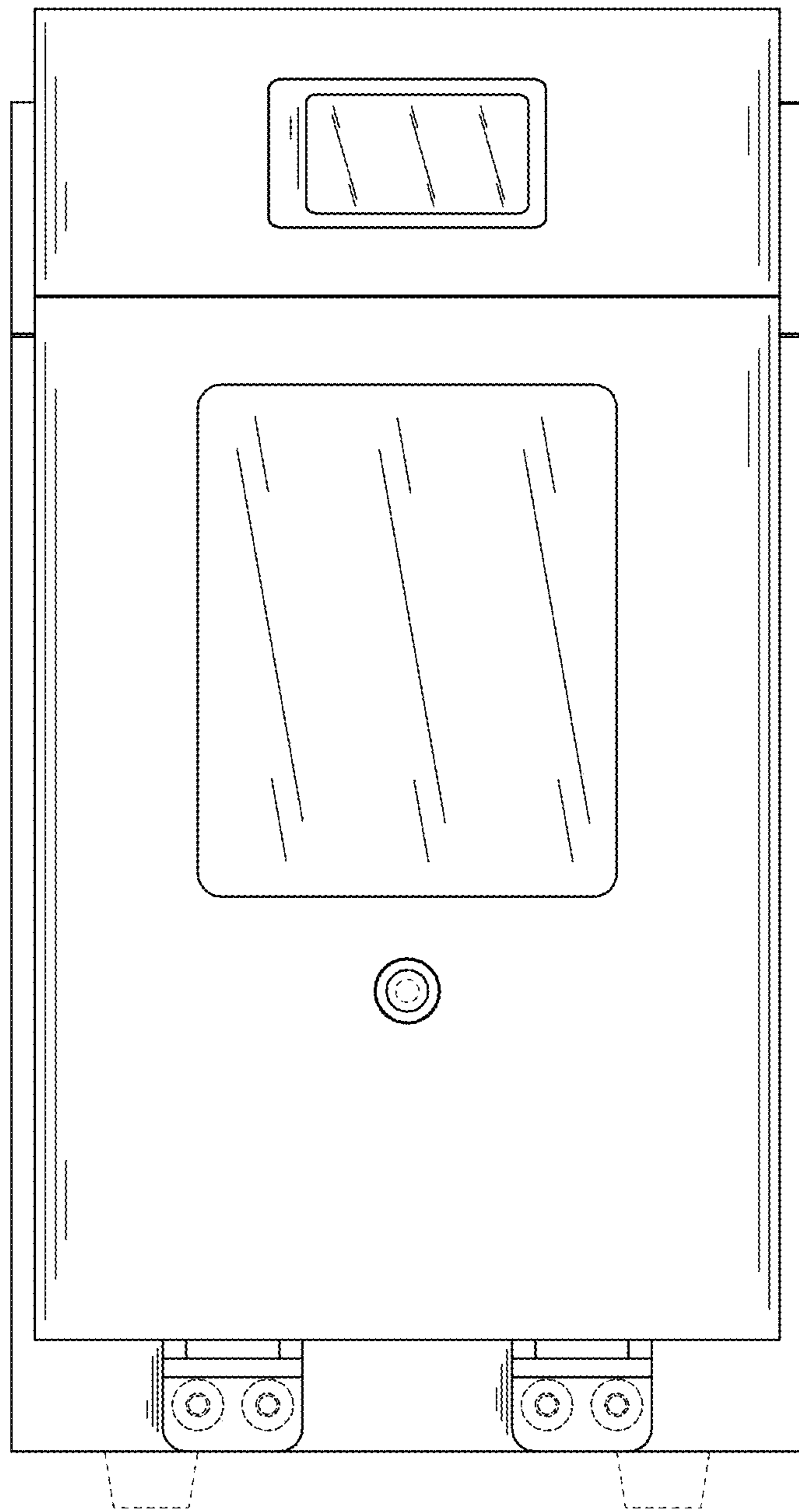

FIG. 3

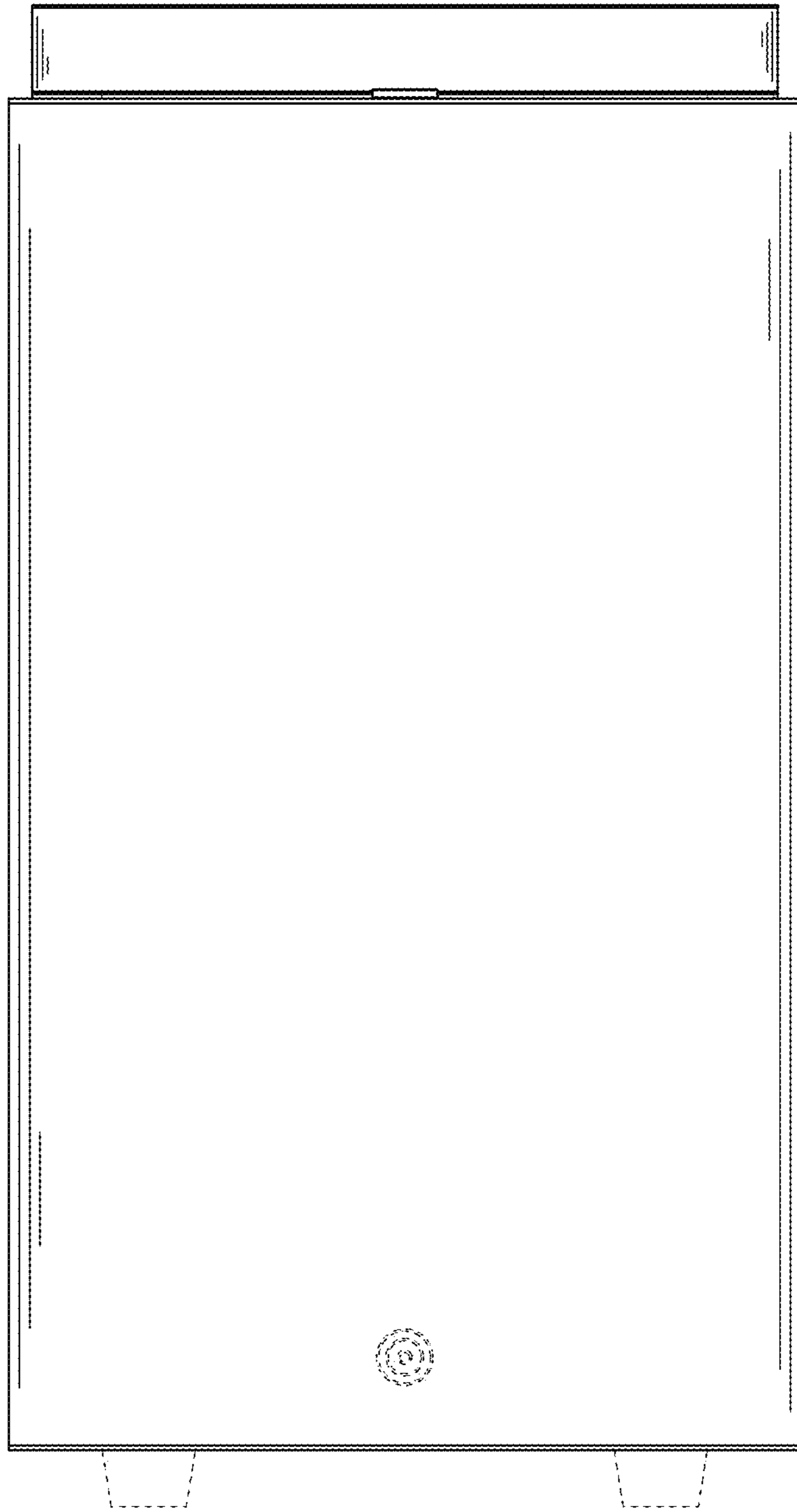

FIG. 4

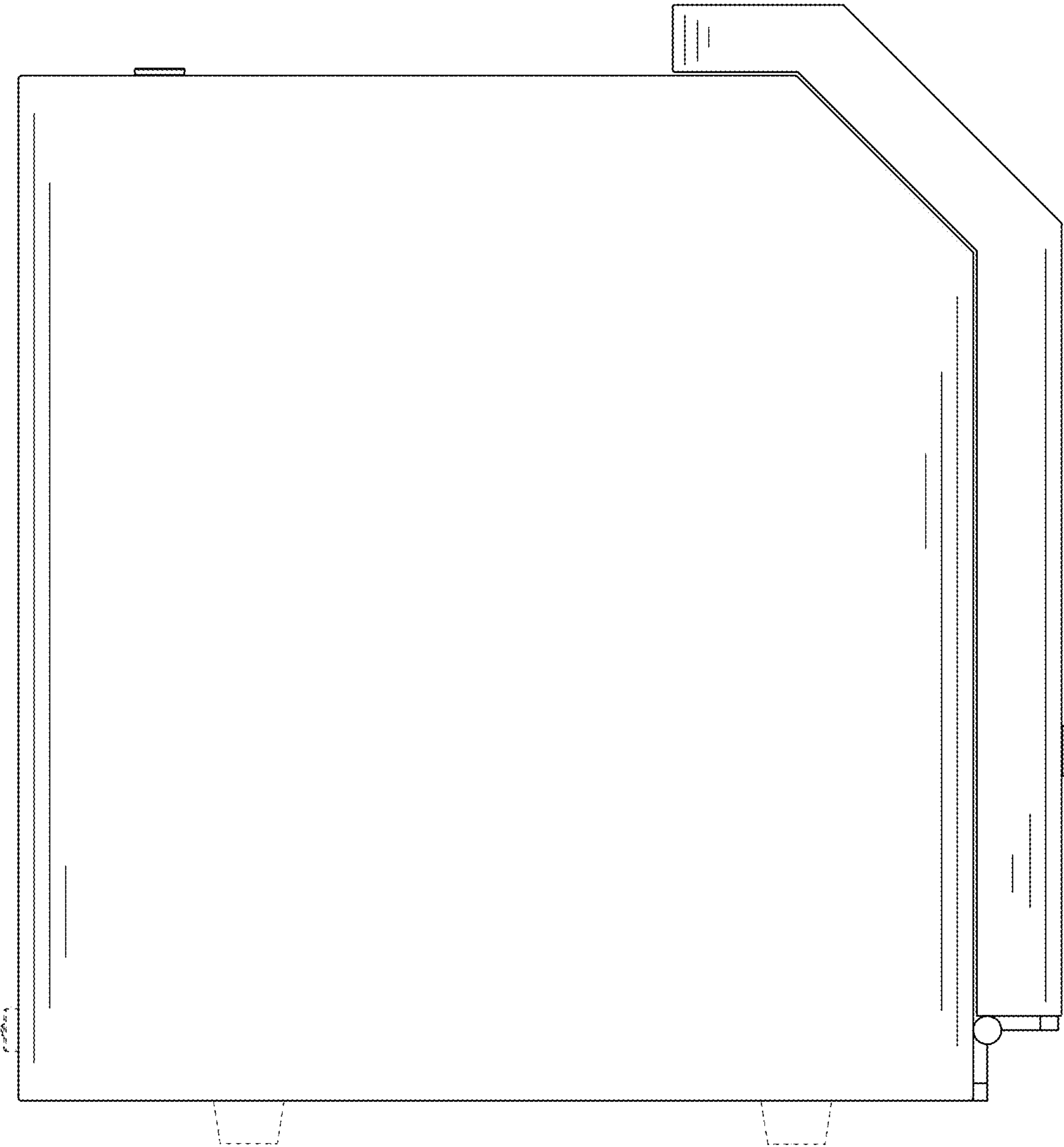

FIG. 5

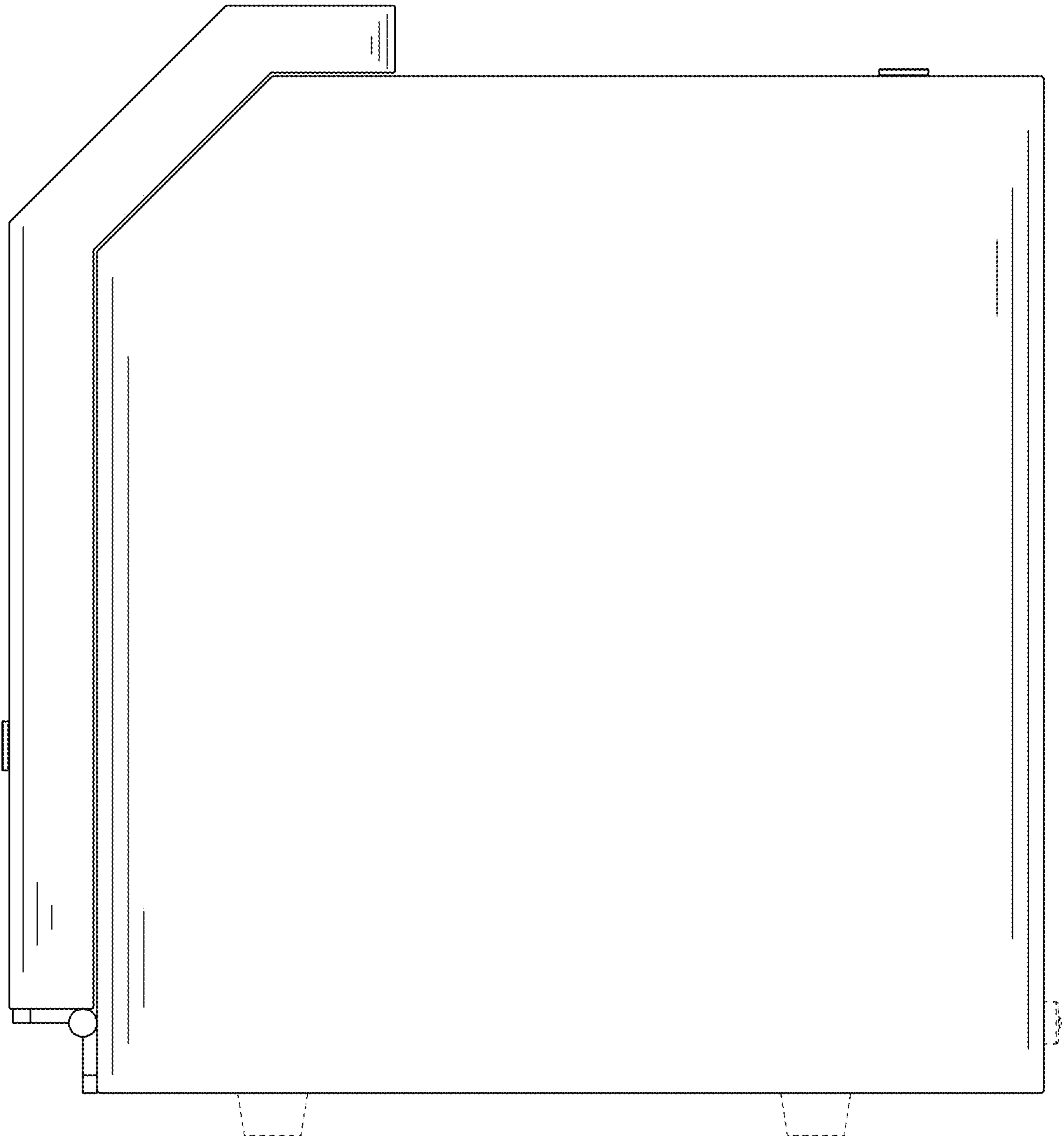

FIG. 6

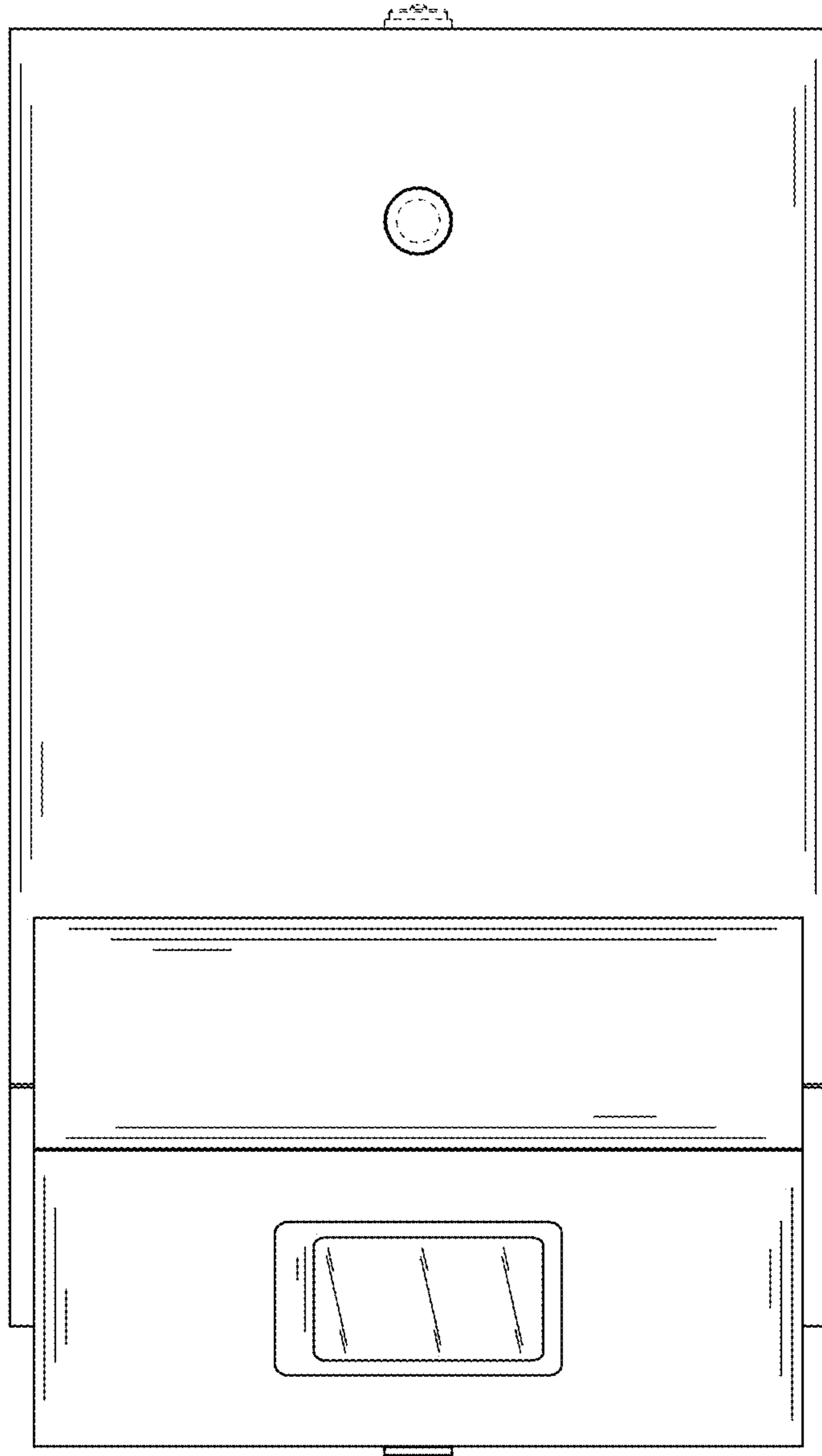

FIG. 7

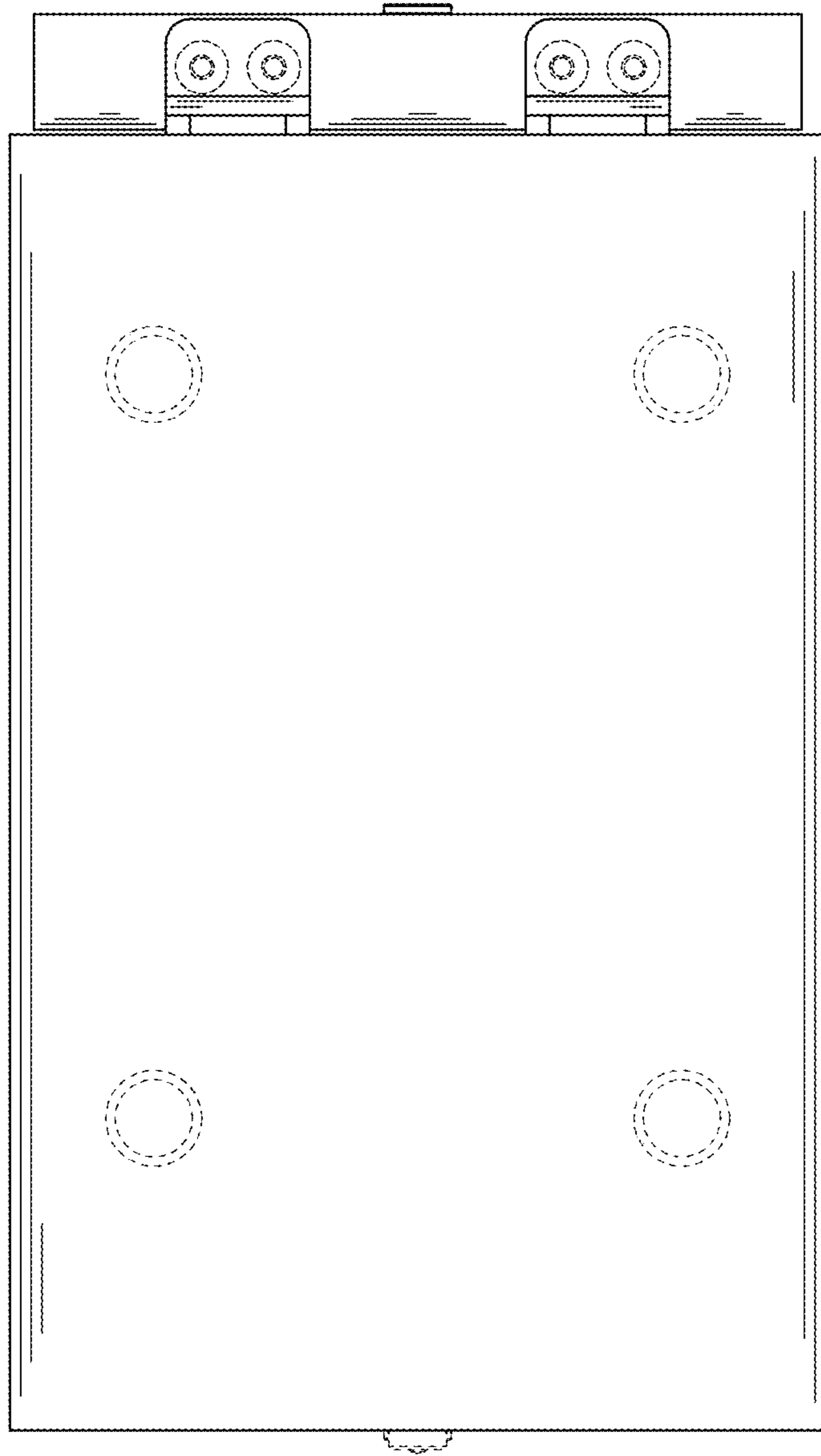

FIG. 8