



US00D972643S

(12) **United States Design Patent** (10) **Patent No.:** **US D972,643 S**  
**Lu** (45) **Date of Patent:** **\*\* Dec. 13, 2022**

(54) **REMOTE GAME CONTROLLER**  
(71) Applicant: **Shenzhen YiDianTong Ecommerce Co., Ltd, Shenzhen (CN)**  
(72) Inventor: **Ping Lu, Shenzhen (CN)**  
(\*\*) Term: **15 Years**  
(21) Appl. No.: **29/759,370**

D577,025 S \* 9/2008 Ashida ..... D21/333  
D594,066 S \* 6/2009 Oikawa ..... D21/333  
D594,067 S \* 6/2009 Oikawa ..... D21/333  
7,774,155 B2 \* 8/2010 Sato ..... A63F 13/428  
345/169  
D636,772 S \* 4/2011 Cheng ..... D21/333  
D638,841 S \* 5/2011 Musick, Jr. .... D21/333  
D644,695 S \* 9/2011 Falc ..... D14/218  
8,267,786 B2 \* 9/2012 Ikeda ..... A63F 13/2145  
463/36

(Continued)

(22) Filed: **Nov. 23, 2020**  
(51) **LOC (13) Cl.** ..... **21-01**  
(52) **U.S. Cl.**  
USPC ..... **D21/333**  
(58) **Field of Classification Search**  
USPC ..... D21/325, 326, 327, 333, 324, 328, 332,  
D21/566, 329, 330, 694; D14/401, 400,  
D14/454, 412, 496, 416, 418, 413, 203.3,  
D14/203.5, 218, 415, 252, 414, 419, 457,  
D14/203, 203.1, 203.7, 204, 217, 240,  
D14/253, 333, 342, 357, 358, 388, 403,  
D14/434, 455, 456, 410, 492, 258, 301,  
D14/393, 432, 489  
CPC ..... G06F 1/1666; G06F 17/00; G06F 19/00;  
A63F 9/24; A63F 13/00; A63F 13/23;  
A63F 13/235; A63F 13/24; A63F 13/26;  
A63F 13/843; A63F 13/98; A63F 13/323;  
A63F 2009/2488; A63F 2009/2407; A63F  
2250/52; A63F 2300/00; A63F  
2300/1031; A63F 2300/8088; A63F  
2300/1025  
See application file for complete search history.

**OTHER PUBLICATIONS**

Wii Gesture Remote Controller and Nunchuck Joystick. Date First Available: Mar. 26, 2020. Retrieved from internet: <<https://www.amazon.com/dp/B086DRBQMV?th=1>> [site visited Mar. 10, 2022] (Year: 2020).\*

(Continued)

*Primary Examiner* — Katherine Glennon  
*Assistant Examiner* — Yuan Yuan  
(74) *Attorney, Agent, or Firm* — Rumit Ranjit Kanakia

(57) **CLAIM**

The ornamental design for a remote game controller, as shown and described.

**DESCRIPTION**

FIG. 1 is a perspective view of a remote game controller showing my new design;  
FIG. 2 is a front view thereof;  
FIG. 3 is a back view thereof;  
FIG. 4 is a left side view thereof;  
FIG. 5 is a right side view thereof;  
FIG. 6 is a top view thereof; and,  
FIG. 7 is a bottom view thereof.  
The broken lines shown in the drawings depict portions of the remote game controller that form no part of the claimed design.

**1 Claim, 7 Drawing Sheets**

(56) **References Cited**

**U.S. PATENT DOCUMENTS**

D559,254 S \* 1/2008 Ashida ..... D21/333  
D559,847 S \* 1/2008 Ashida ..... D21/333  
D563,409 S \* 3/2008 Liu ..... D21/333  
D575,284 S \* 8/2008 Ashida ..... D21/333  
D575,285 S \* 8/2008 Ashida ..... D21/333  
D576,624 S \* 9/2008 Ashida ..... D21/333



(56)

**References Cited**

U.S. PATENT DOCUMENTS

8,308,563 B2 \* 11/2012 Ikeda ..... A63F 13/42  
463/36  
8,313,379 B2 \* 11/2012 Ikeda ..... A63F 13/98  
345/158  
8,550,915 B2 \* 10/2013 Ashida ..... A63F 13/02  
345/161  
D728,029 S \* 4/2015 Ray ..... D21/324  
2007/0052177 A1 \* 3/2007 Ikeda ..... A63F 13/24  
273/317  
2008/0171596 A1 \* 7/2008 Hsu ..... A63F 13/212  
463/39  
2009/0048021 A1 \* 2/2009 Lian, Jr. .... G06F 3/0346  
455/352  
2009/0082108 A1 \* 3/2009 Ye ..... A63F 13/06  
463/39

OTHER PUBLICATIONS

Luxmo Premium 2 in 1 Wii Controller Motion Plus. Date First Available: Feb. 18, 2020. Retrieved from internet: <<https://www.amazon.com/LUXMO-PREMIUM-Controller-Controllers-Replacement/dp/B084ZZCXK1>> [site visited Mar. 10, 2022] (Year: 2020).\*

\* cited by examiner

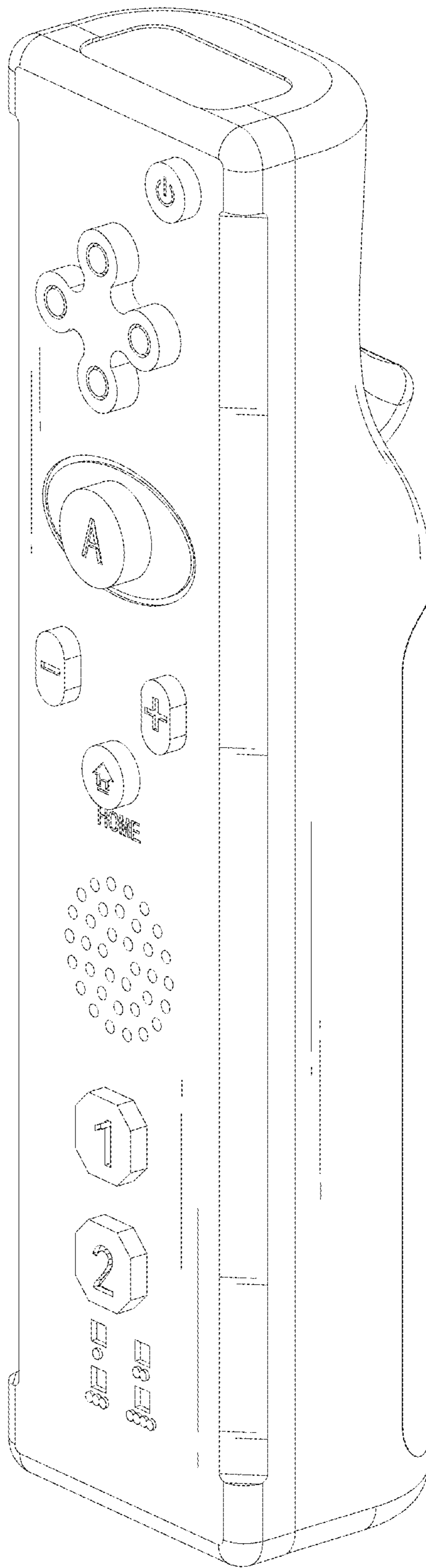

FIG. 1

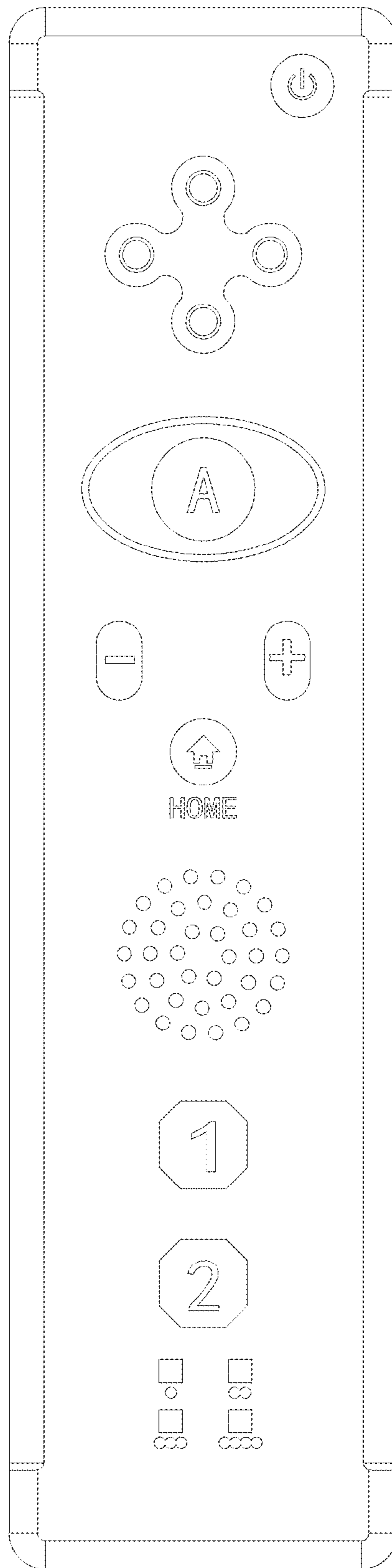

FIG.2

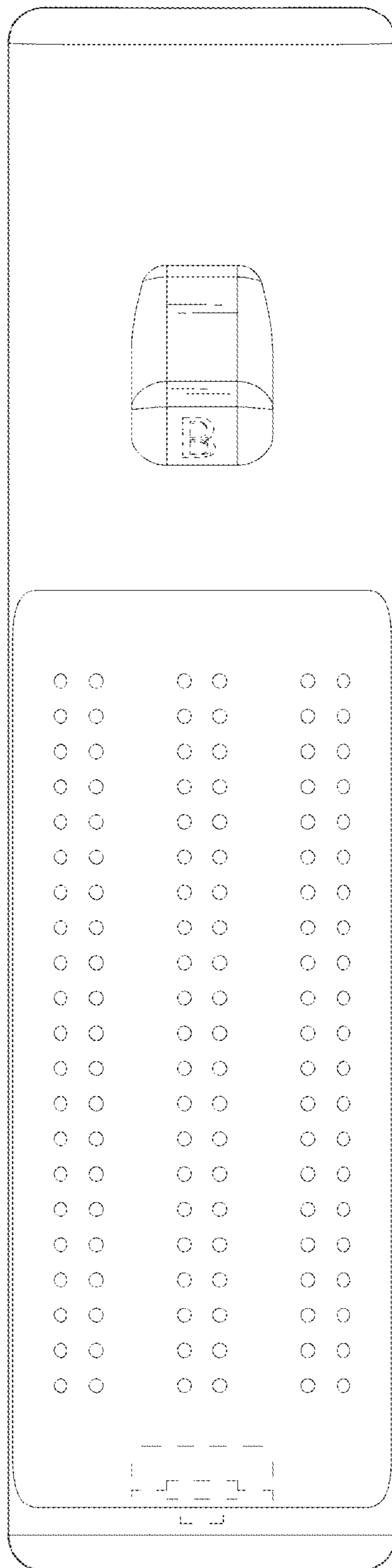

FIG. 3

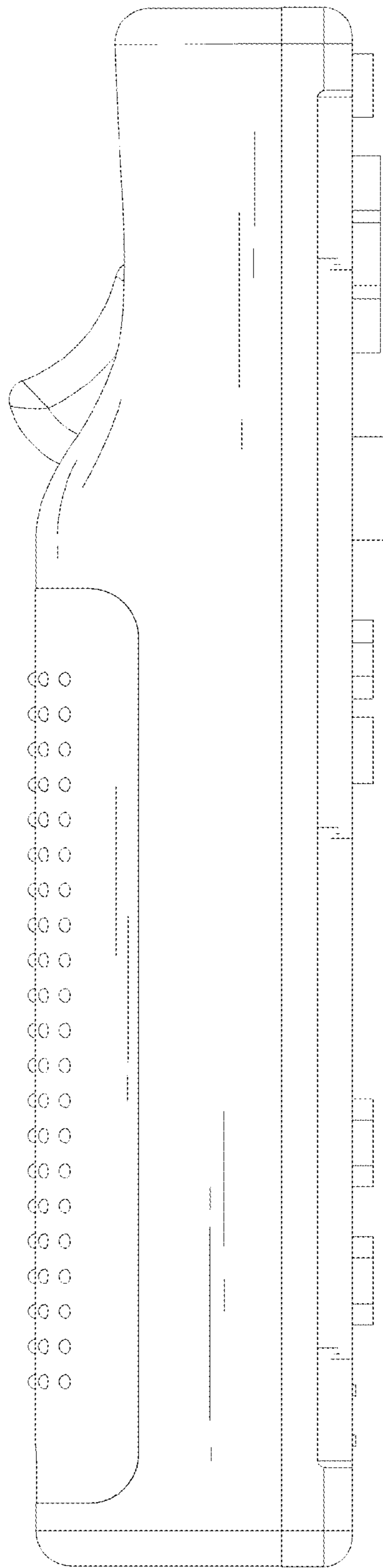

FIG. 4



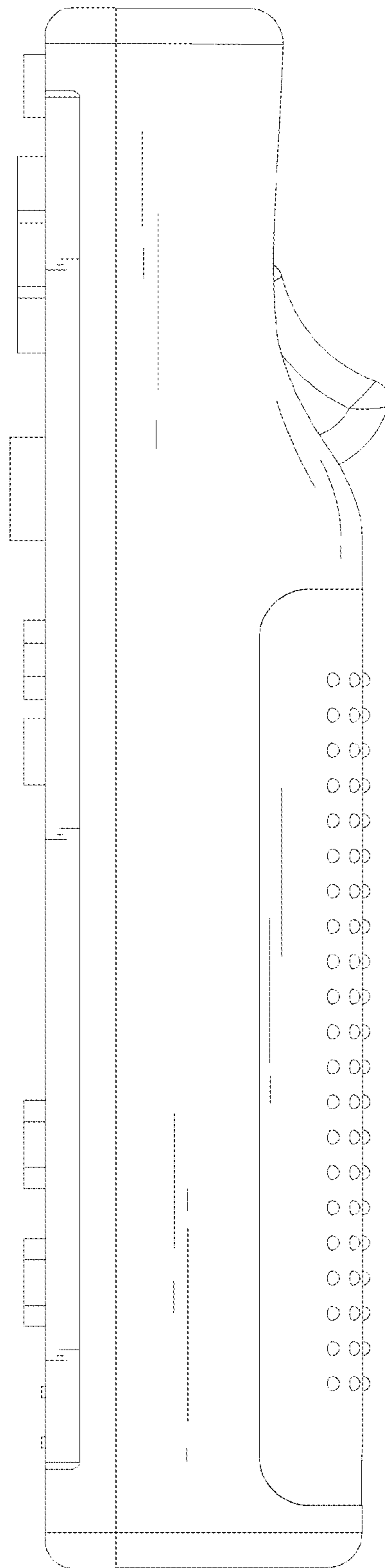

FIG. 5

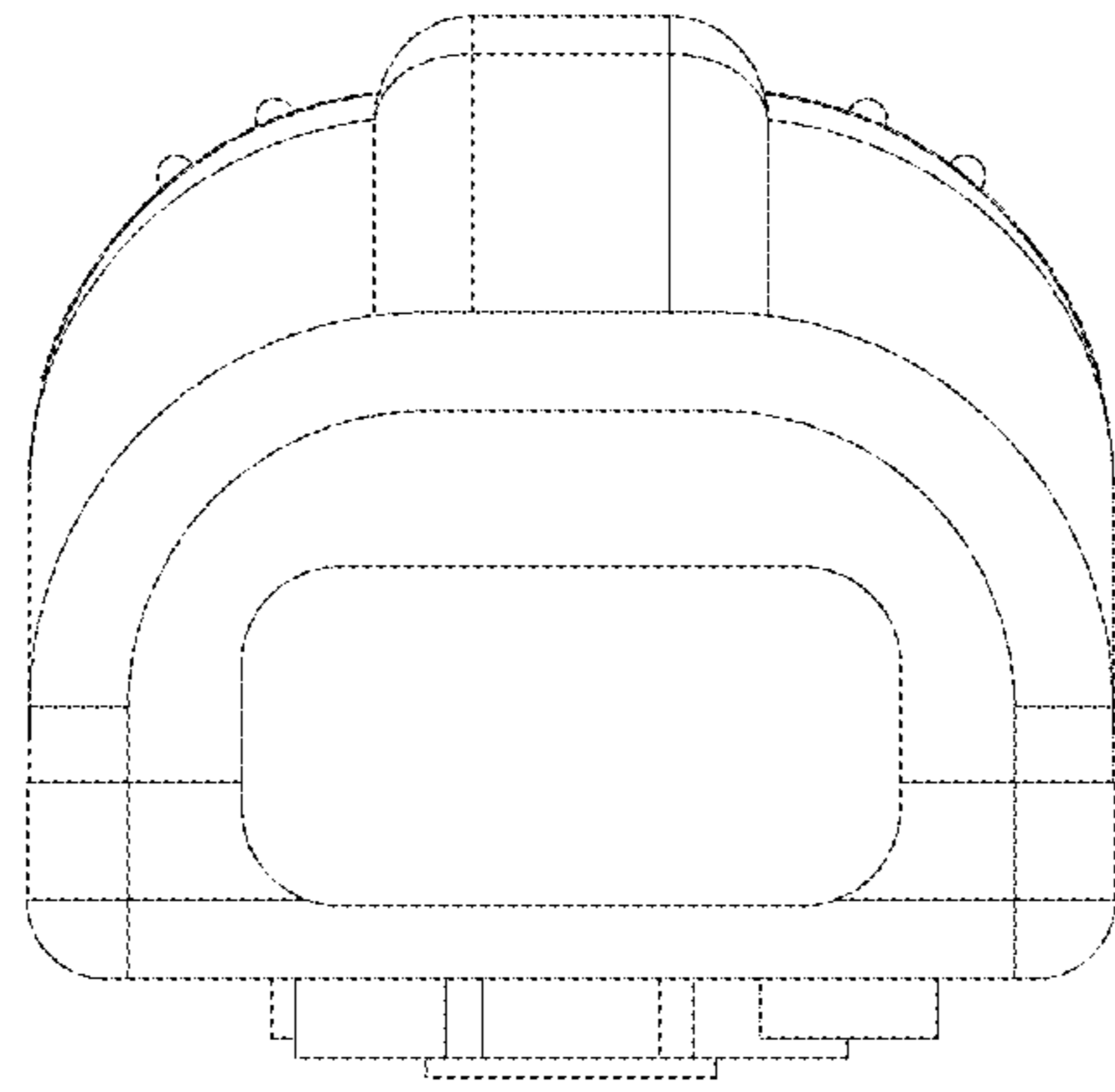

FIG. 6



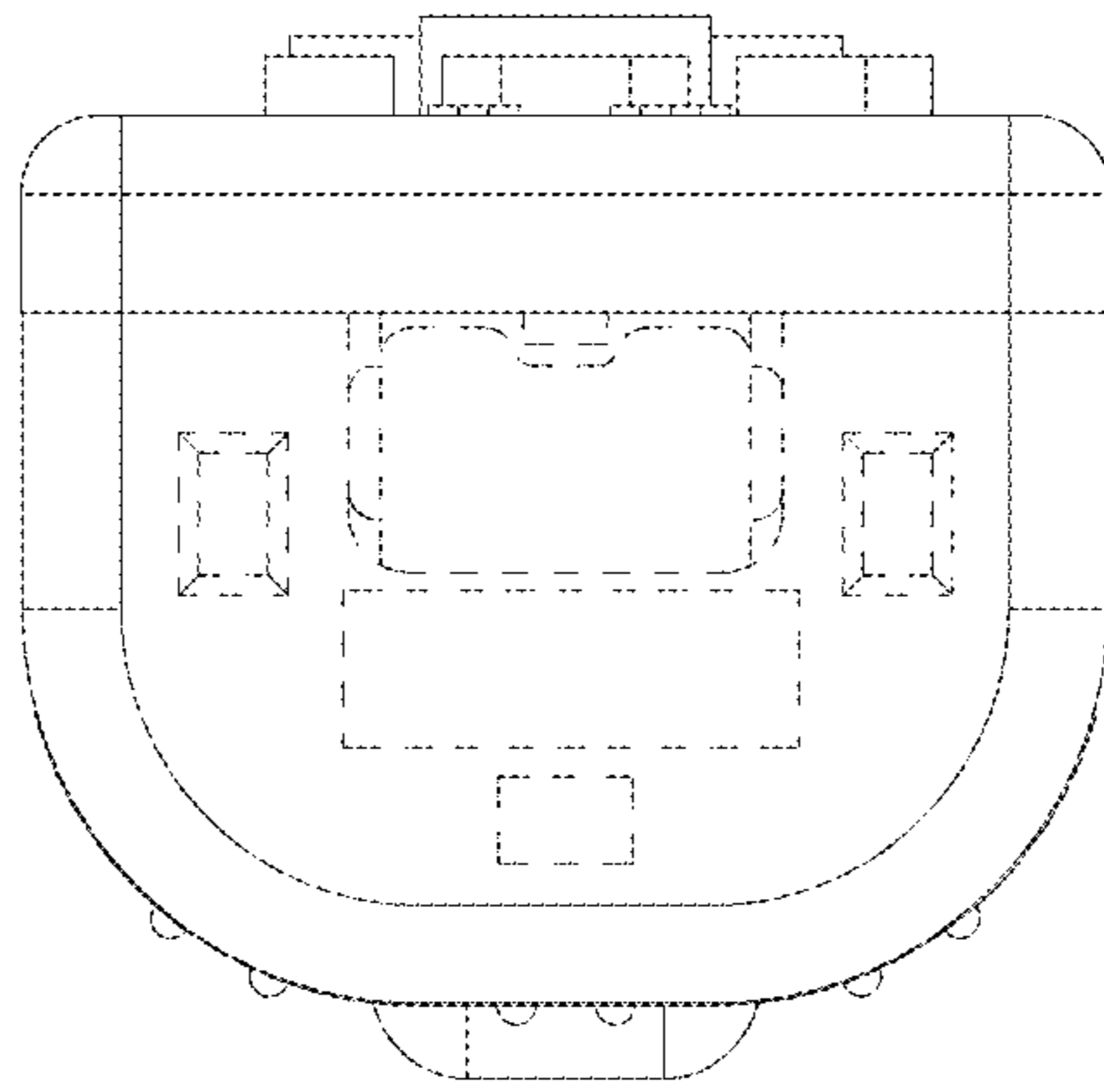

FIG. 7