



US00D972563S

(12) **United States Design Patent** (10) **Patent No.:** **US D972,563 S**
Wu (45) **Date of Patent:** **** Dec. 13, 2022**

(54) **STYLUS**
(71) Applicant: **Jing Wu**, Guangdong Province (CN)
(72) Inventor: **Jing Wu**, Guangdong Province (CN)
(**) Term: **15 Years**
(21) Appl. No.: **29/791,217**
(22) Filed: **Jan. 5, 2022**
(51) **LOC (13) Cl.** **14-02**
(52) **U.S. Cl.**
USPC **D14/411**
(58) **Field of Classification Search**
USPC D14/411
CPC G06F 3/0383; G06F 3/03545; H01Q 1/362
See application file for complete search history.

D944,799 S * 3/2022 Huang D14/411
D944,800 S * 3/2022 Huang D14/411
D956,871 S * 7/2022 Vadenne D19/186
2014/0104187 A1 * 4/2014 Bakken G06F 3/03545
345/173
2017/0139492 A1 * 5/2017 Chang G06F 3/03545
2019/0056806 A1 * 2/2019 Yeh G06F 3/0383
2020/0097102 A1 * 3/2020 Zhang H01Q 1/362

FOREIGN PATENT DOCUMENTS

JP D1710718 * 9/2020

OTHER PUBLICATIONS

QGeem Stylus Pen, Qgeem tineye image date Aug. 2, 2022, <https://www.qgeem.com/products/stylus-pen-for-ipad-qgeem-ipad-pencil-with-palm-rejection-compatible-with-2018-2021-apple-ipad-pro-11-12-9-inch-ipad-6th-7th-8th-g>; https://tineye.com/search/76835ce87f3fb8aa41043eb0cc6d4630a5583cff?sort=score&order=desc&page=2.*

* cited by examiner

Primary Examiner — John R Yeh

(57) **CLAIM**

The ornamental design for a stylus, as shown and described.

DESCRIPTION

FIG. 1 is a perspective view of a stylus, showing my new design;
FIG. 2 is another perspective view;
FIG. 3 is a front view thereof;
FIG. 4 is a rear view thereof;
FIG. 5 is a left side view thereof;
FIG. 6 is a right side view thereof;
FIG. 7 is a top plan view thereof; and,
FIG. 8 is a bottom plan view thereof.

1 Claim, 8 Drawing Sheets

(56) **References Cited**

U.S. PATENT DOCUMENTS

D322,250 S * 12/1991 Valls D19/180
D356,306 S * 3/1995 Ady D14/411
D465,806 S * 11/2002 Hu D14/411
D641,755 S * 7/2011 Rashid D14/411
D681,038 S * 4/2013 Tomohiro D14/411
D709,949 S 7/2014 Fleming
D717,301 S * 11/2014 Groene D19/934
D771,630 S * 11/2016 Akana D14/411
D772,875 S 11/2016 Kim et al.
D825,566 S * 8/2018 Peterson D14/411
D861,689 S * 10/2019 Nishizawa D14/411
D887,412 S * 6/2020 Nishizawa D14/411
D892,800 S * 8/2020 Xu D14/411
D896,810 S * 9/2020 Akana D14/411
D908,703 S * 1/2021 Huang D14/411
D909,379 S * 2/2021 Liu D14/411
D909,380 S * 2/2021 Liu D14/411
D914,683 S * 3/2021 Son D14/411
D921,628 S * 6/2021 Huang D14/411
D921,632 S * 6/2021 Huang D14/411
D921,633 S * 6/2021 Huang D14/411

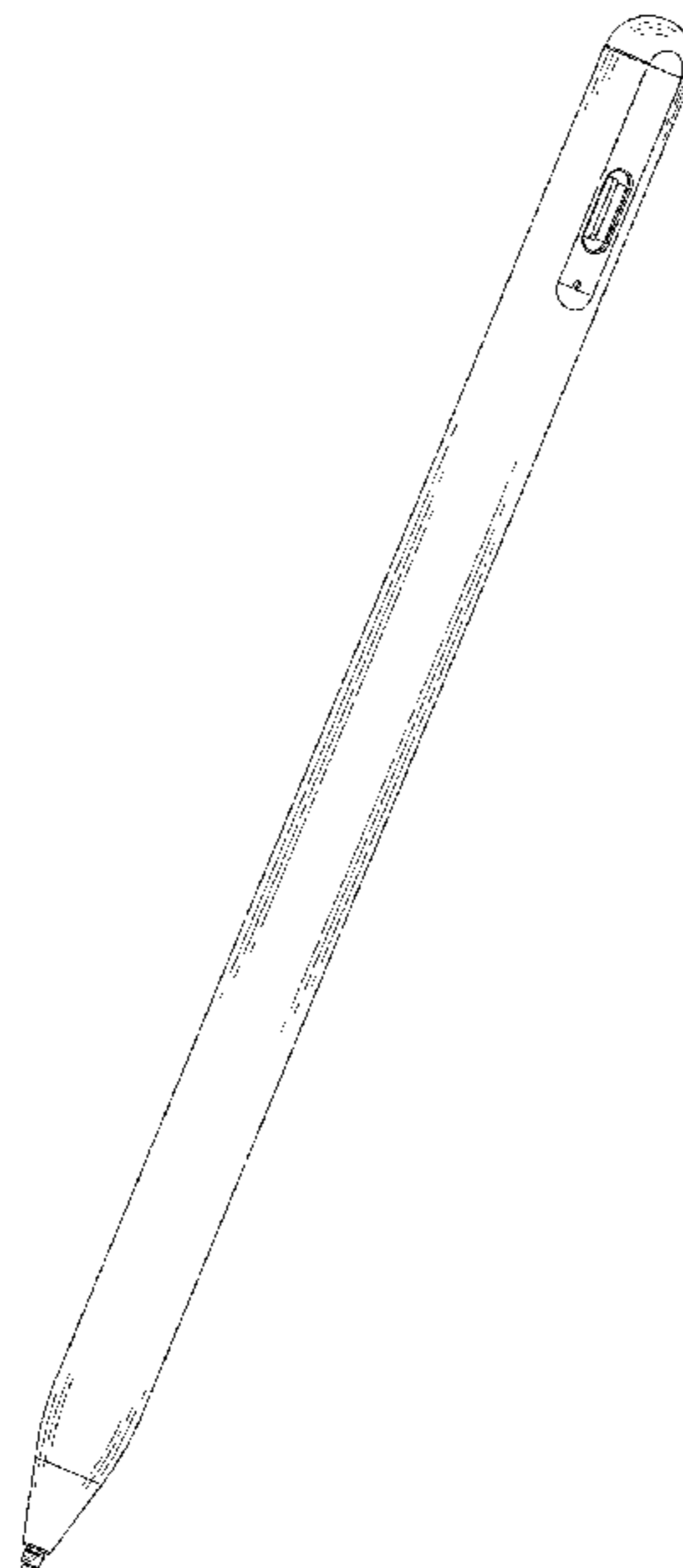

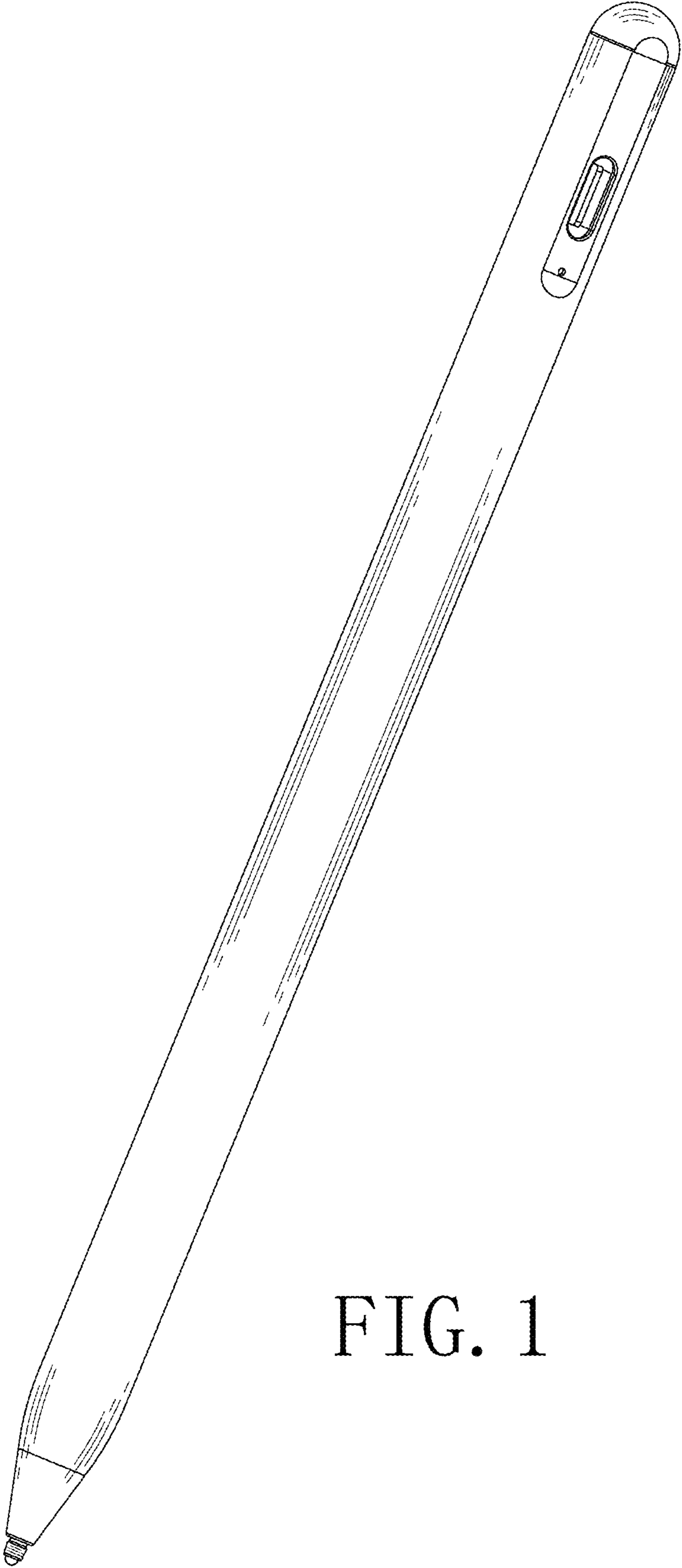

FIG. 1

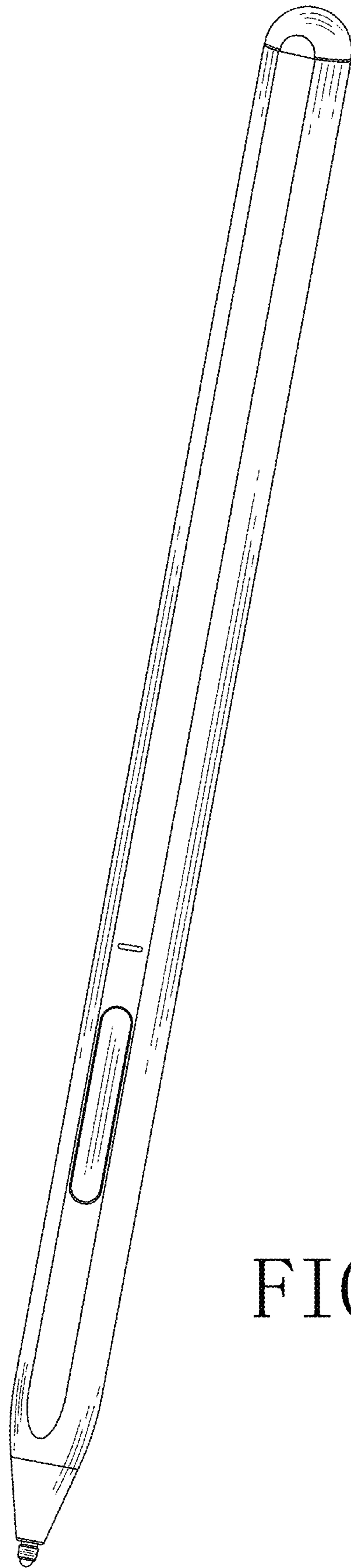

FIG. 2



FIG. 3

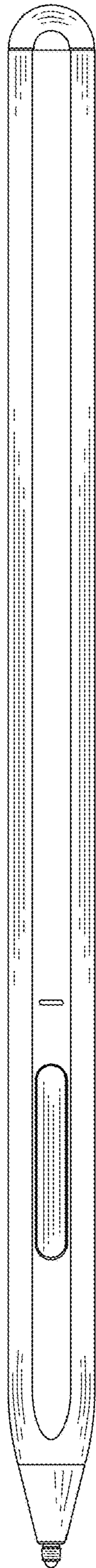

FIG. 4

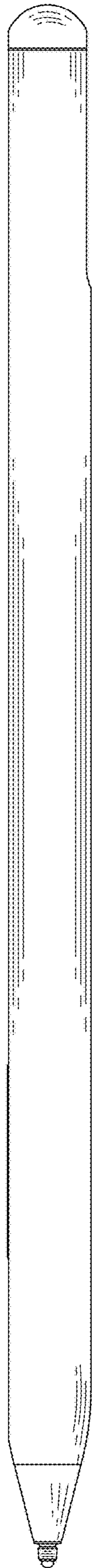

FIG. 5

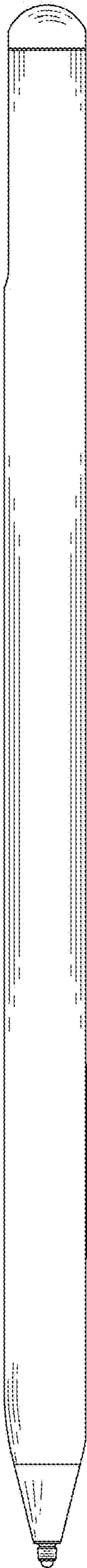

FIG. 6

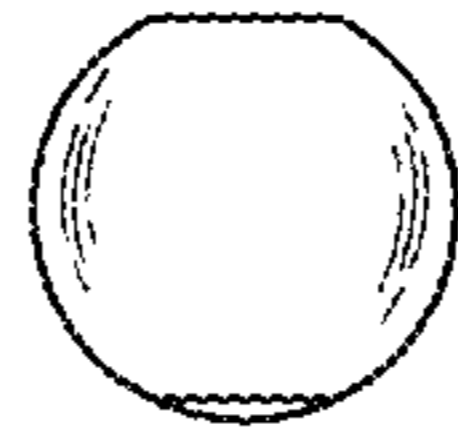

FIG. 7

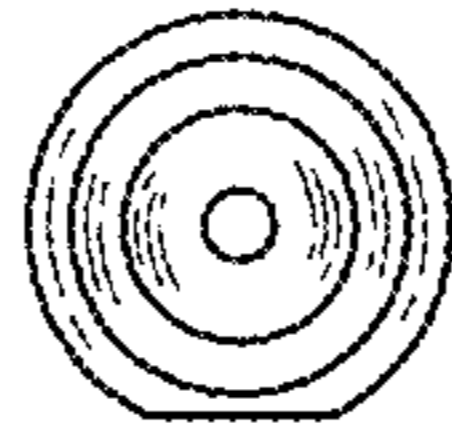

FIG. 8