



US00D972552S

(12) **United States Design Patent** (10) **Patent No.:** **US D972,552 S**  
**Son et al.** (45) **Date of Patent:** **\*\* Dec. 13, 2022**

(54) **MULTIMEDIA KIOSK**

(56) **References Cited**

(71) Applicant: **LG ELECTRONICS INC.**, Seoul (KR)

U.S. PATENT DOCUMENTS

(72) Inventors: **Sanghyeun Son**, Seoul (KR); **Seungmo Kang**, Seoul (KR); **Inkoo Shim**, Seoul (KR); **Taeil Kim**, Seoul (KR)

D711,870 S *	8/2014	Johnson .....	D14/307
D842,296 S *	3/2019	Gross .....	D14/307
D857,007 S *	8/2019	Pitallano .....	D14/307
D873,262 S *	1/2020	Fernando .....	D14/307
D888,705 S *	6/2020	Saito .....	D14/307
D900,089 S *	10/2020	Harris .....	D14/307
D900,804 S *	11/2020	Mugica .....	D14/307
D924,223 S *	7/2021	You .....	D14/307
D950,545 S *	5/2022	Harvey .....	D14/307
D962,219 S *	8/2022	Jung .....	D14/307

(73) Assignee: **LG ELECTRONICS INC.**, Seoul (KR)

(\*\*) Term: **15 Years**

\* cited by examiner

(21) Appl. No.: **35/512,777**

*Primary Examiner* — Austin Murphy

(22) Filed: **Apr. 22, 2021**

(74) *Attorney, Agent, or Firm* — Birch, Stewart, Kolasch & Birch, LLP

(80) **Hague Agreement Data**

Int. Filing Date: **Apr. 22, 2021**  
Int. Reg. No.: **DM/214322**  
Int. Reg. Date: **Apr. 22, 2021**  
Int. Reg. Pub. Date: **Oct. 22, 2021**

(57) **CLAIM**

The ornamental design for a multimedia kiosk, as shown and described.

(30) **Foreign Application Priority Data**

**DESCRIPTION**

Nov. 20, 2020 (KR) ..... 30-2020-0056558

(51) **LOC (13) Cl.** ..... **14-02**

(52) **U.S. Cl.**  
USPC ..... **D14/307**

(58) **Field of Classification Search**  
USPC ..... D14/302-307, 900-902; D13/163;  
D20/10; D21/332, 325, 369, 370;  
D99/28; D6/397, 466; 194/206;  
361/679.01, 679.02, 679.04, 679.21,  
361/679.57, 725  
CPC ..... G06Q 20/18; G06Q 20/10; G06Q 20/123;  
G06Q 20/20; G06Q 30/02; G06Q 30/06;  
A47F 9/047

- 1. Multimedia kiosk
- 1.1 : Perspective
- 1.2 : Rear perspective view
- 1.3 : Front
- 1.4 : Back
- 1.5 : Left
- 1.6 : Right
- 1.7 : Top
- 1.8 : Bottom

The subject design is a multimedia kiosk that can be installed where the user wants to receive necessary information and use a webcam and microphone according to their convenience.

See application file for complete search history.

**1 Claim, 8 Drawing Sheets**

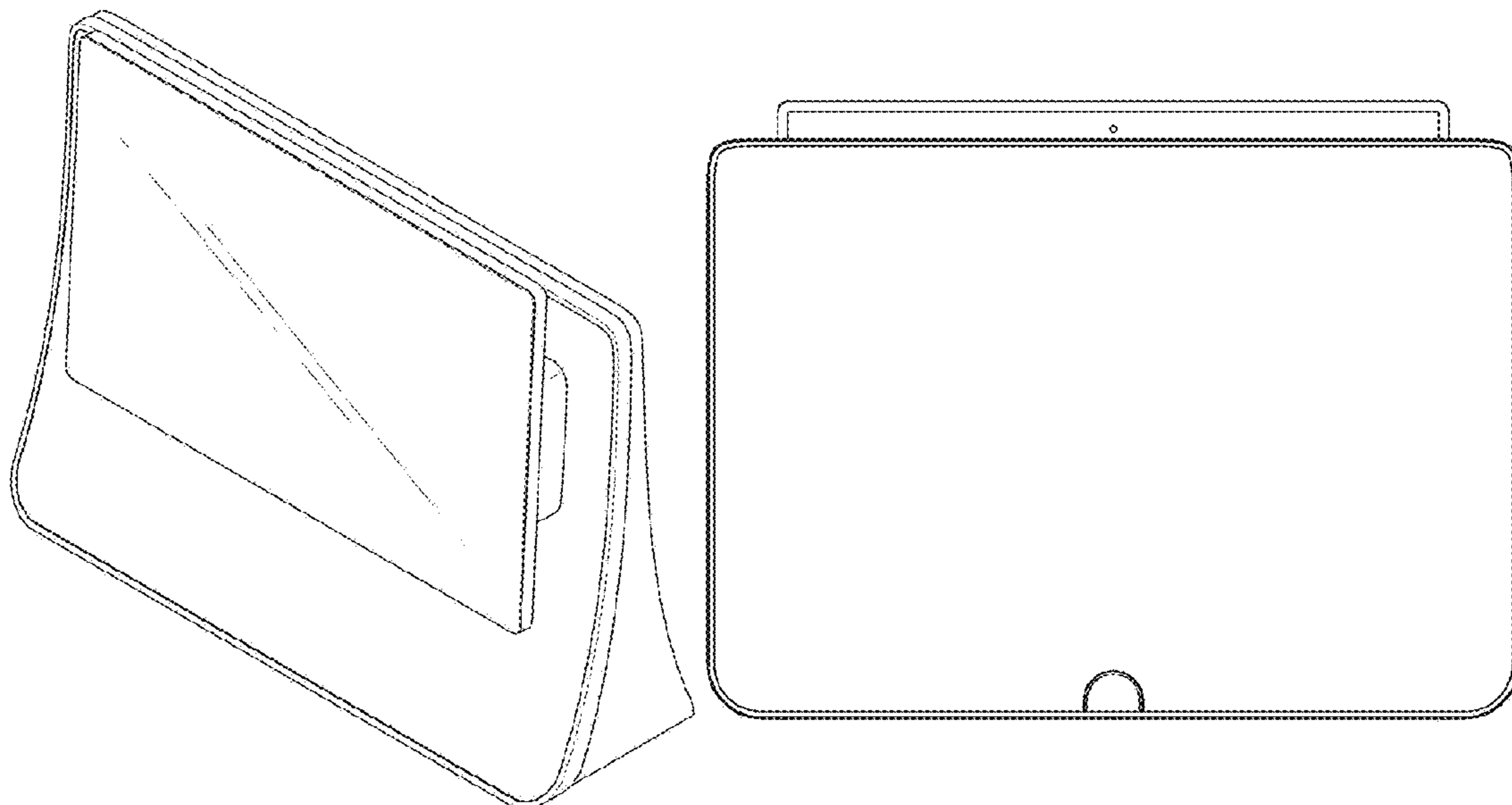

1.1

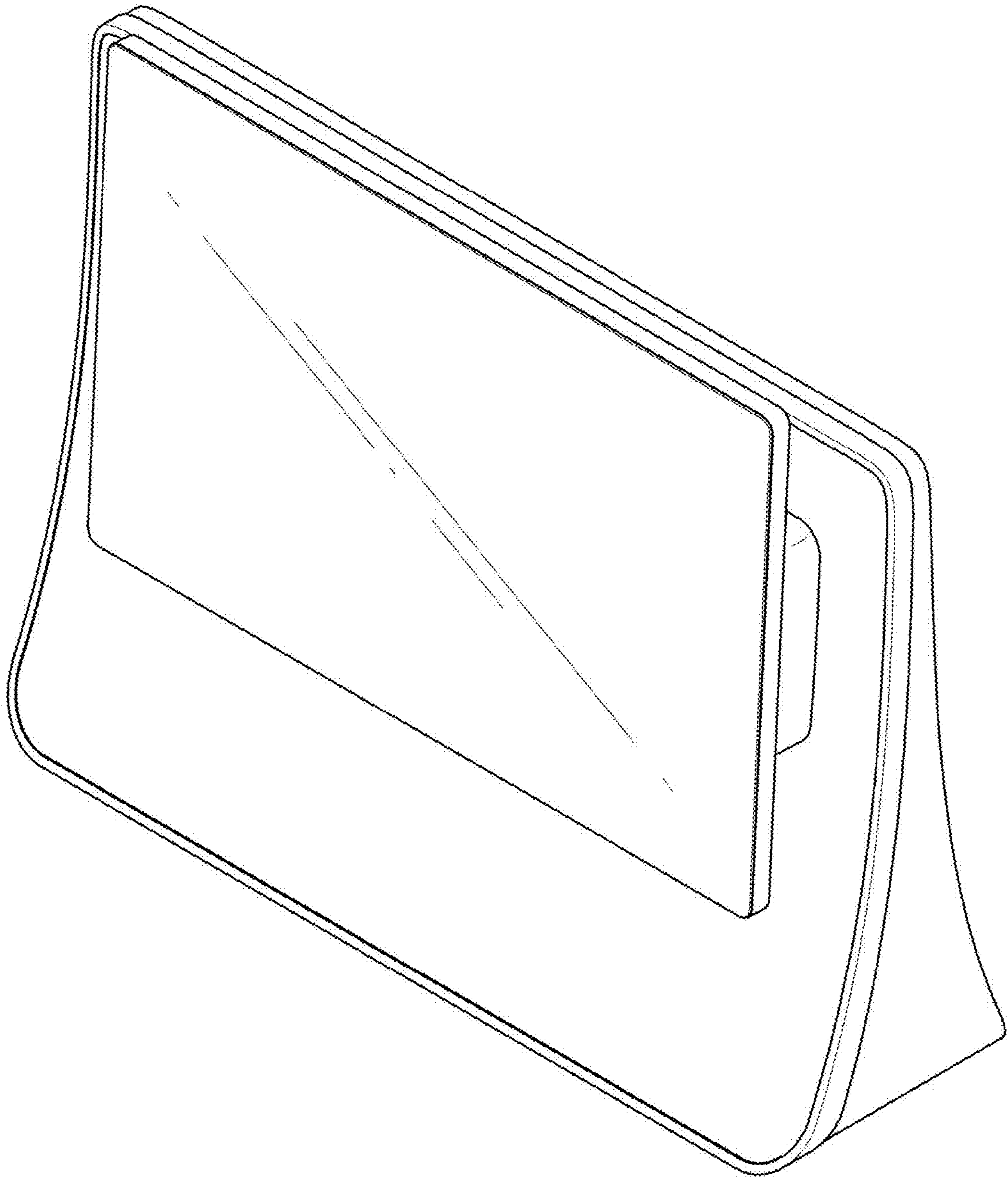

1.2

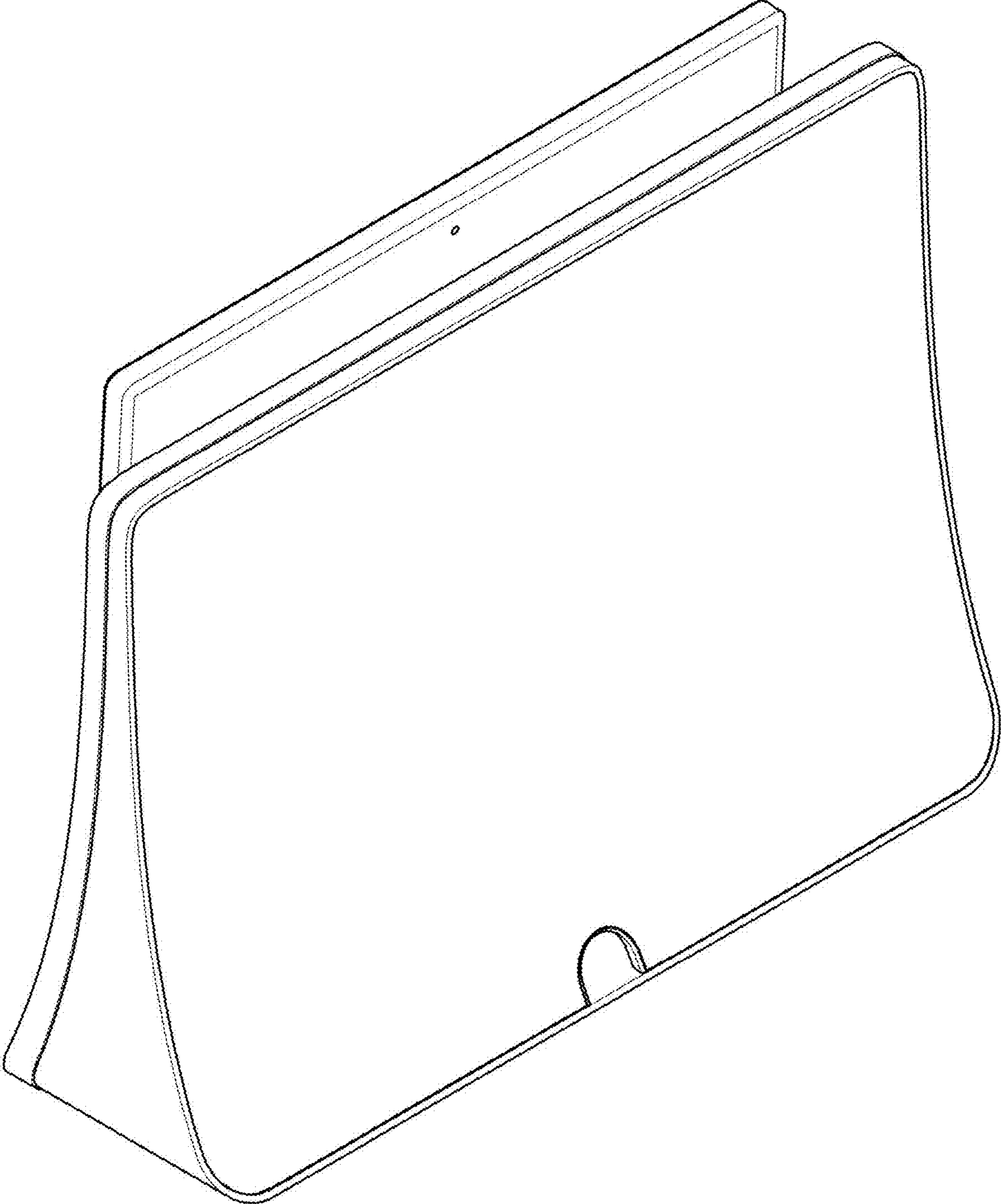

1.3

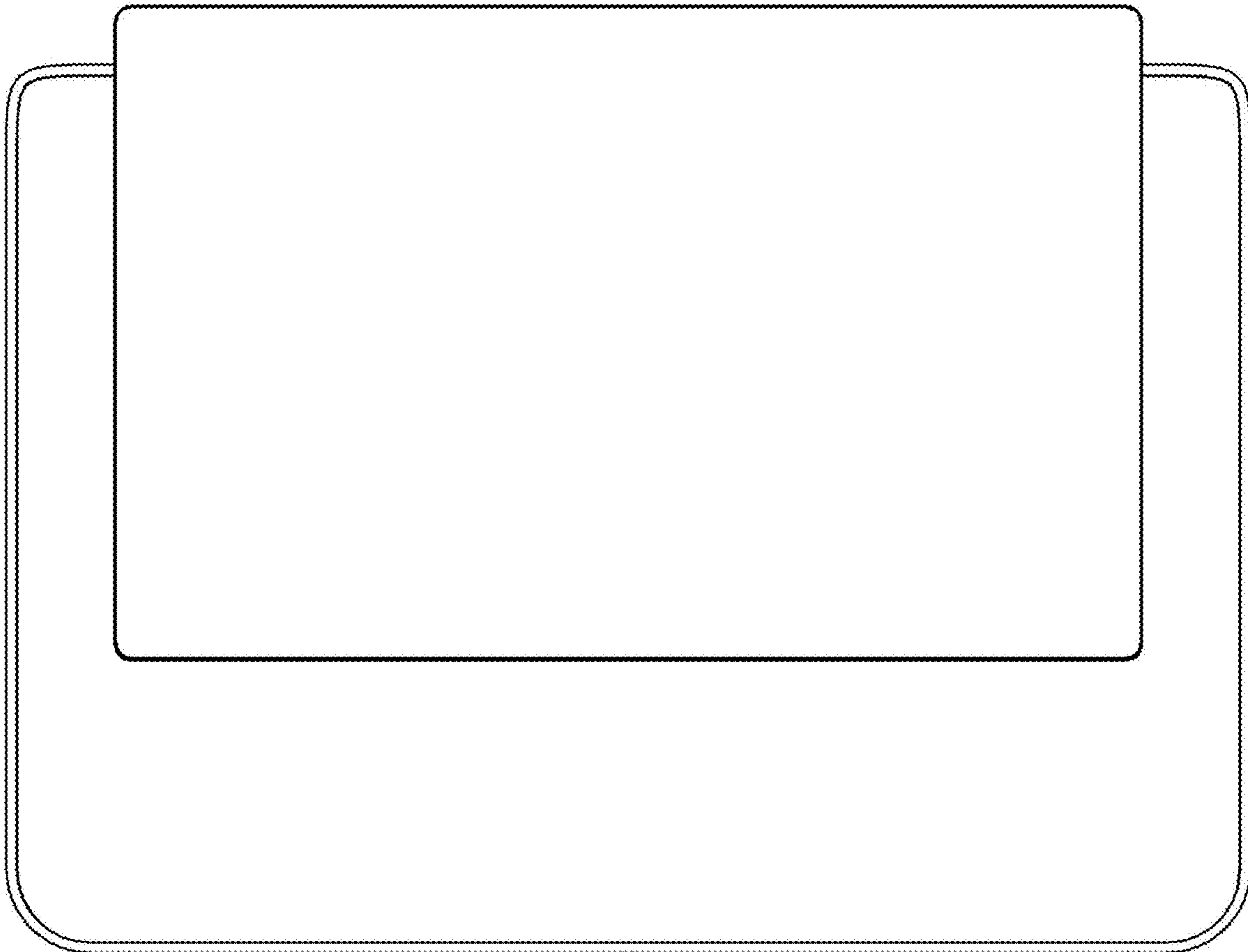

1.4

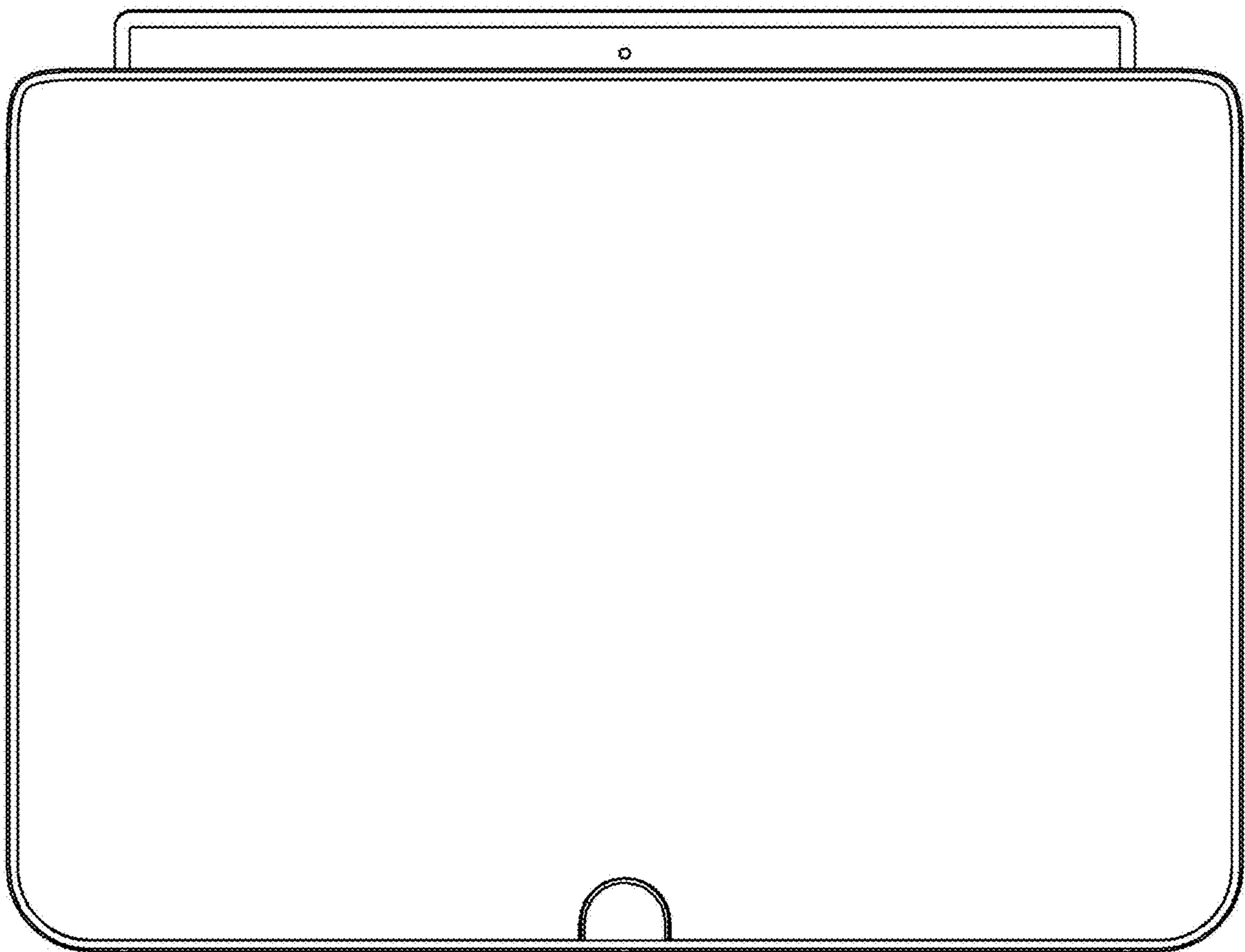



1.5

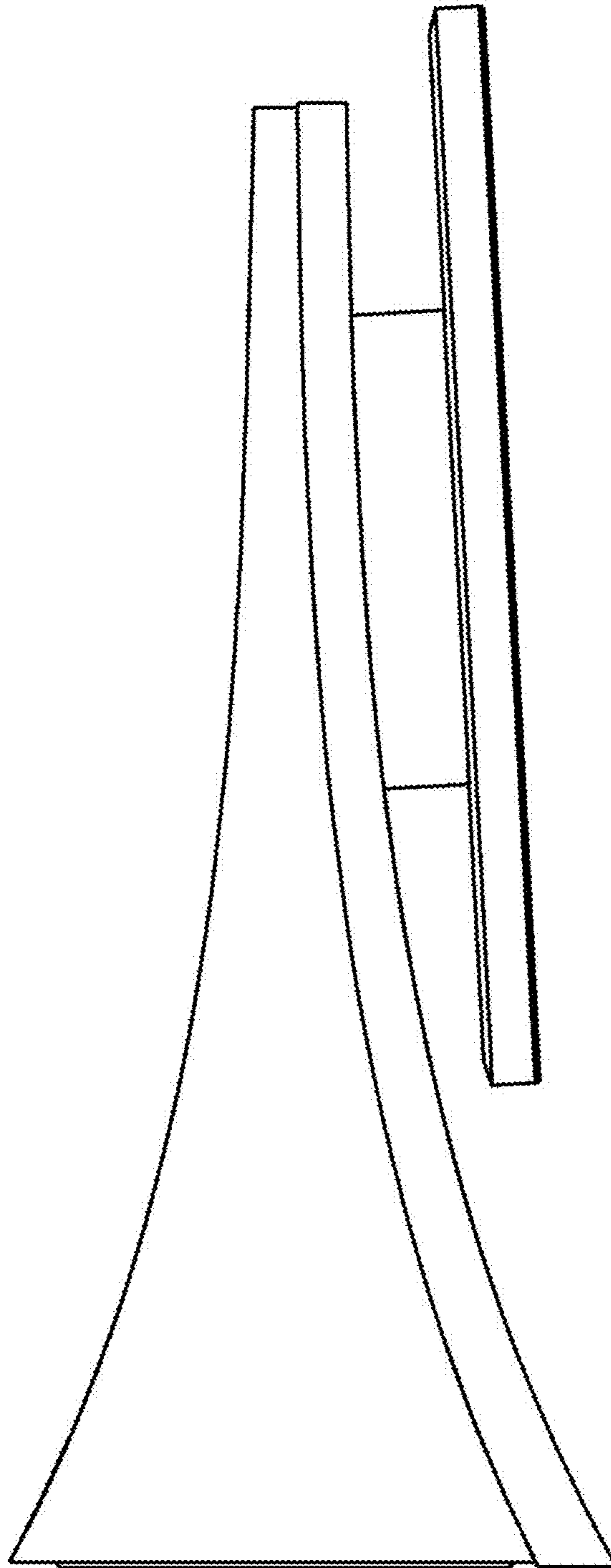

1.6

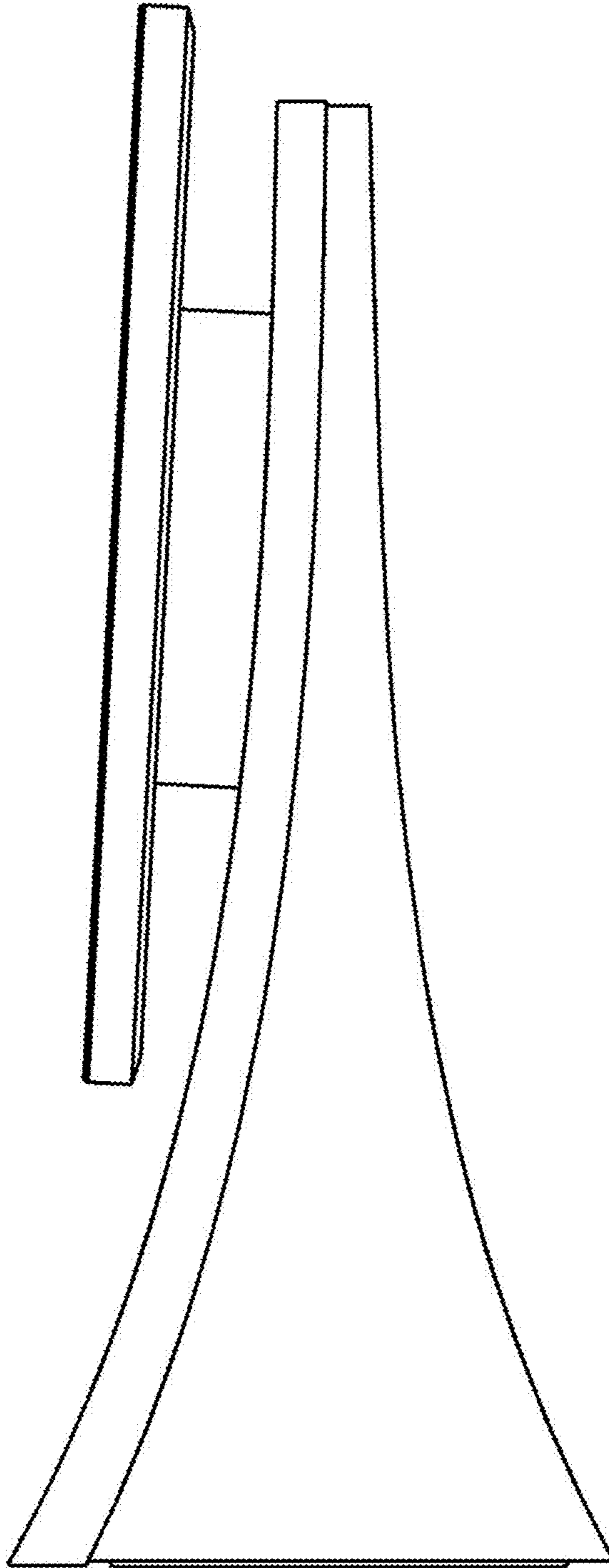

1.7

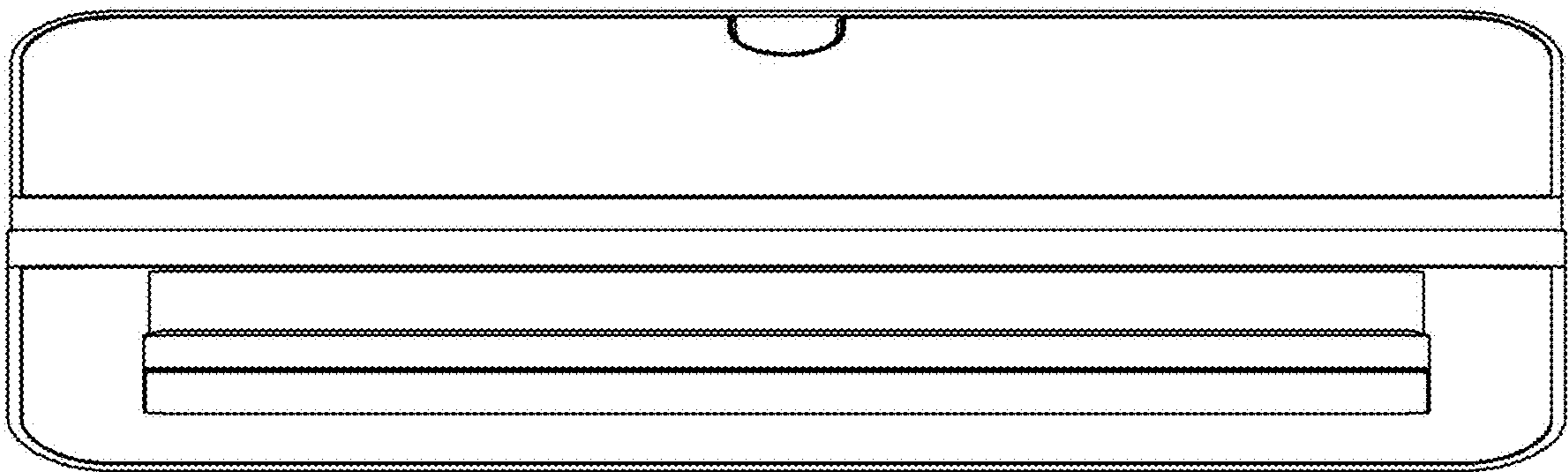



1.8

