



US00D972551S

(12) **United States Design Patent** (10) **Patent No.:** **US D972,551 S**
Yoo (45) **Date of Patent:** **** Dec. 13, 2022**

(54) **MOBILE PHONE HOLDER**
(71) Applicant: **MOMOSTICK CO., LTD.**, Incheon (KR)
(72) Inventor: **Hyun Joo Yoo**, Incheon (KR)
(**) Term: **15 Years**
(21) Appl. No.: **35/512,791**
(22) Filed: **Apr. 29, 2021**
(80) **Hague Agreement Data**
Int. Filing Date: **Apr. 29, 2021**
Int. Reg. No.: **DM/215801**
Int. Reg. Date: **Apr. 29, 2021**
Int. Reg. Pub. Date: **Oct. 29, 2021**

(30) **Foreign Application Priority Data**
Oct. 30, 2020 (KR) 30-2020-0052236
(51) **LOC (13) Cl.** **14-03**
(52) **U.S. Cl.**
USPC **D14/253; D3/218**
(58) **Field of Classification Search**
USPC D14/217, 250–253, 440, 447; D3/218
CPC A45F 2200/0525; A45F 2005/1006; A45F 2005/008; A45F 2200/0516; A45F 3/14; A45F 5/00; A45F 5/10
See application file for complete search history.

(56) **References Cited**
U.S. PATENT DOCUMENTS
D669,267 S * 10/2012 Mecchella D3/289
D689,479 S * 9/2013 Softer D14/253
D703,647 S * 4/2014 Kim D14/250
D705,767 S * 5/2014 Yoon D14/250
D721,373 S * 1/2015 Logereau D14/432
D723,569 S * 3/2015 Peng D14/440
D725,659 S * 3/2015 Tussy D14/440

D738,872 S * 9/2015 Erickson-Davis D3/218
D756,339 S * 5/2016 Tussy D14/250
D778,275 S * 2/2017 Gabriel D14/250
D794,007 S * 8/2017 Zhang D14/250
D814,212 S * 4/2018 Tuang D6/566
D817,316 S * 5/2018 Srour D14/251
D826,236 S * 8/2018 Chang D14/439
D830,367 S * 10/2018 Chang D14/440
D831,635 S * 10/2018 Gibson D14/250
10,201,221 B1 * 2/2019 Chang A45F 5/10
D842,290 S * 3/2019 Robertson D14/251
D845,955 S * 4/2019 Zhong D14/439
D863,287 S * 10/2019 Srour D14/251

(Continued)

Primary Examiner — Janice Hallmark

(57) **CLAIM**
The ornamental design for a mobile phone holder, as shown and described.

DESCRIPTION

1. Mobile phone holder
1.1 : Perspective
1.2 : Front
1.3 : Back
1.4 : Left
1.5 : Right
1.6 : Top
1.7 : Bottom
1.8 : Perspective
1.9 : Perspective
This article is a mobile phone holder which can be attached onto the back side of a mobile phone or the back side of a mobile phone case; the part to be protected is displayed as a solid line and the part to be unprotected is displayed as a dotted line; a boundary between the part to be protected and the part to be unprotected is displayed as an alternated long and short dash line; **1.9** is a perspective view showing use. The dotted lines in Fig. **1.9** showing a mobile phone case illustrate environmental subject matter and form no part of the claimed design.

1 Claim, 9 Drawing Sheets

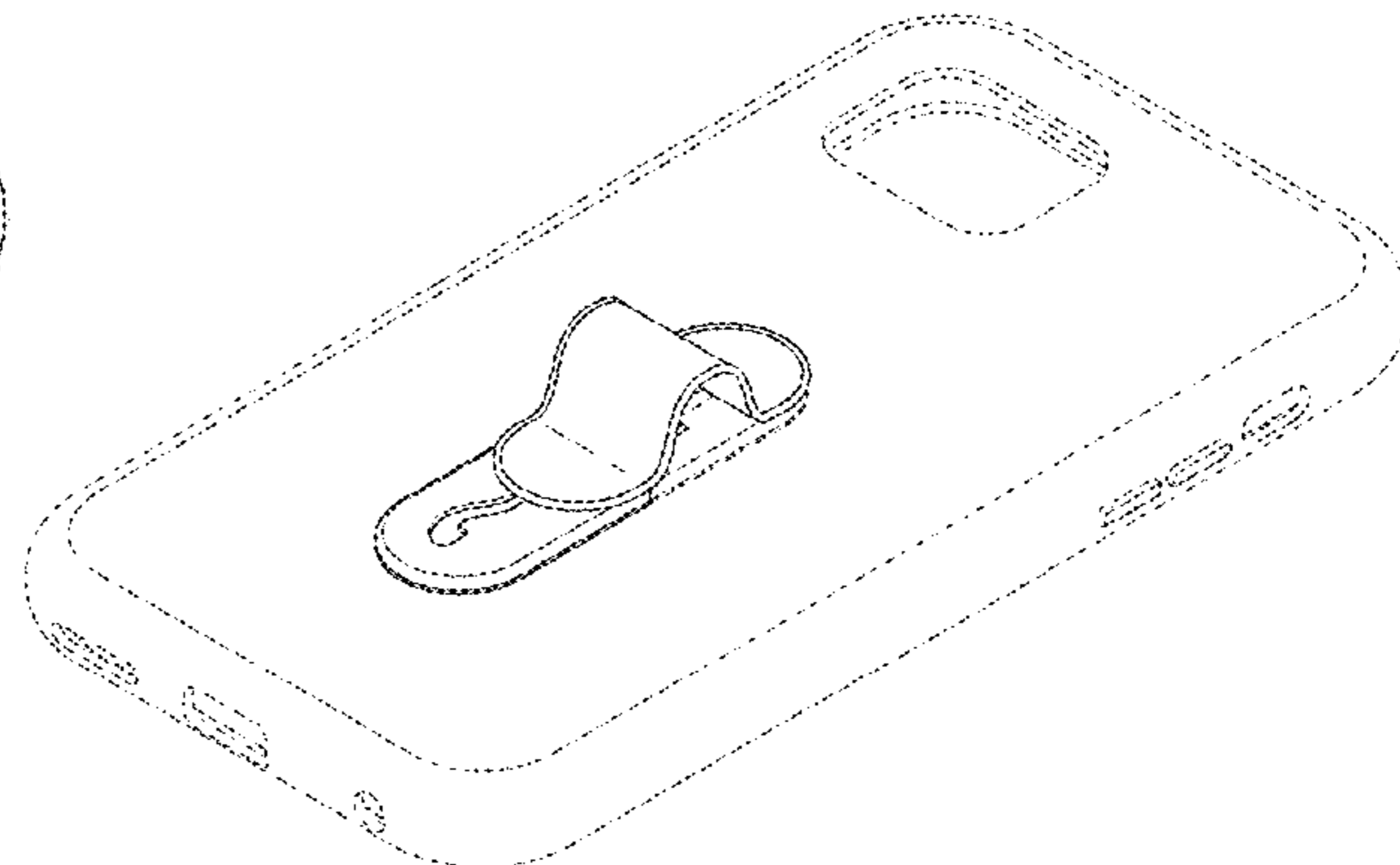
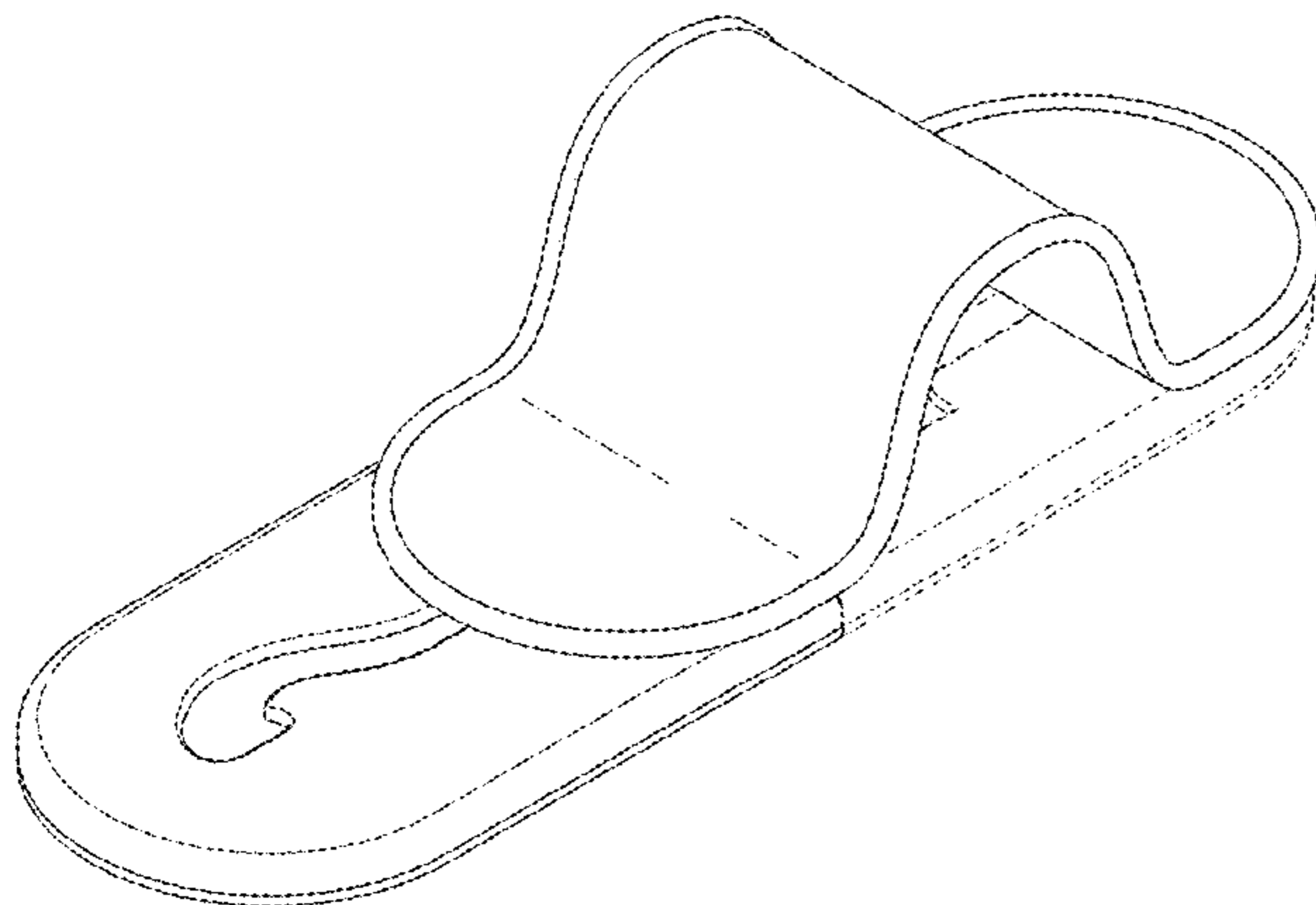

(56)

References Cited

U.S. PATENT DOCUMENTS

D877,154 S * 3/2020 Hummel D14/447
10,610,004 B1 * 4/2020 Yeo A45C 11/182
D883,272 S * 5/2020 Park D14/253
10,694,837 B1 * 6/2020 Altschul H04M 1/04
D894,167 S * 8/2020 Feller D14/251
D894,889 S * 9/2020 Feller D14/251
D916,073 S * 4/2021 Li D14/253
D925,543 S * 7/2021 Ma D14/440
D929,382 S * 8/2021 Gwyn D14/251
D932,482 S * 10/2021 Del Toro D14/253
D933,645 S * 10/2021 Tsang D14/250
D937,250 S * 11/2021 Jakobuco D14/250
D946,562 S * 3/2022 Emery D3/249
D950,238 S * 5/2022 Yeo D3/218
D950,540 S * 5/2022 Yeo D3/218
D952,623 S * 5/2022 Britt H04M 1/18
D14/250
D959,418 S * 8/2022 Huang D3/218
2009/0270050 A1 * 10/2009 Brown A45F 5/00
455/90.3

2010/0222118 A1 * 9/2010 Interdanato A45F 5/00
455/575.6
2014/0077515 A1 * 3/2014 Rasmussen A45F 5/102
294/169
2015/0011269 A1 * 1/2015 Liu H04M 1/0202
455/575.1
2015/0214992 A1 * 7/2015 Gant A45F 5/10
455/575.6
2015/0365125 A1 * 12/2015 Murphy A45F 5/00
455/575.6
2016/0036480 A1 * 2/2016 Hirsch A45F 5/00
455/575.6
2016/0134733 A1 * 5/2016 Murphy A45F 5/00
455/575.6
2016/0345715 A1 * 12/2016 Lin A45C 11/00
2018/0116381 A1 * 5/2018 Koshak G03B 17/563
2018/0234126 A1 * 8/2018 Yeo H04B 1/3888
2018/0241860 A1 * 8/2018 Park H04M 1/04
2019/0055062 A1 * 2/2019 Winn H04B 1/3888
2019/0090621 A1 * 3/2019 Yoo A45F 5/00
2020/0028951 A1 * 1/2020 Hummel H04M 1/04
2020/0093231 A1 * 3/2020 Mora F16M 11/10
2021/0059370 A1 * 3/2021 Del Toro F16M 11/10
2021/0315339 A1 * 10/2021 Yoon H04M 1/04

* cited by examiner

1.1

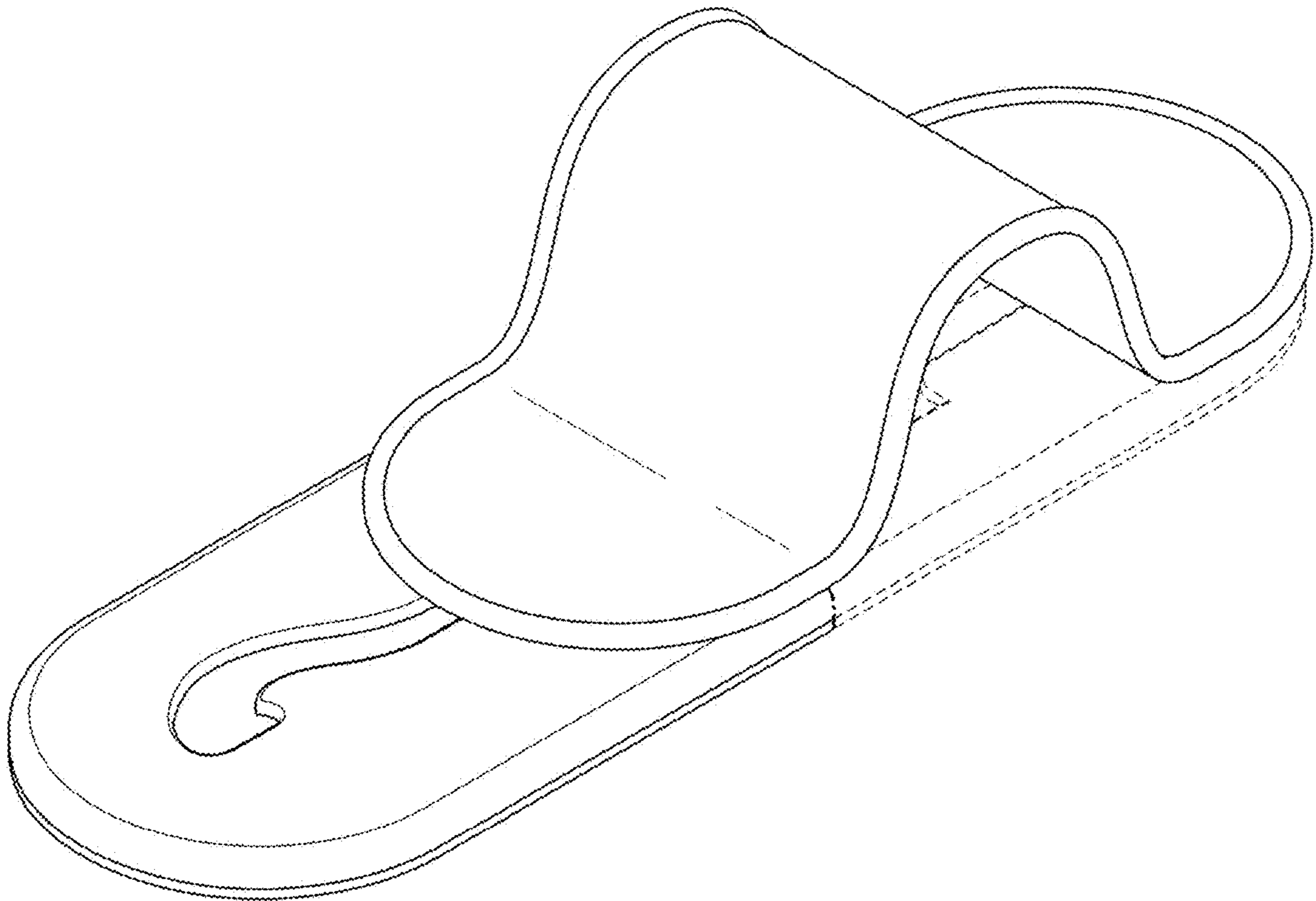

1.2

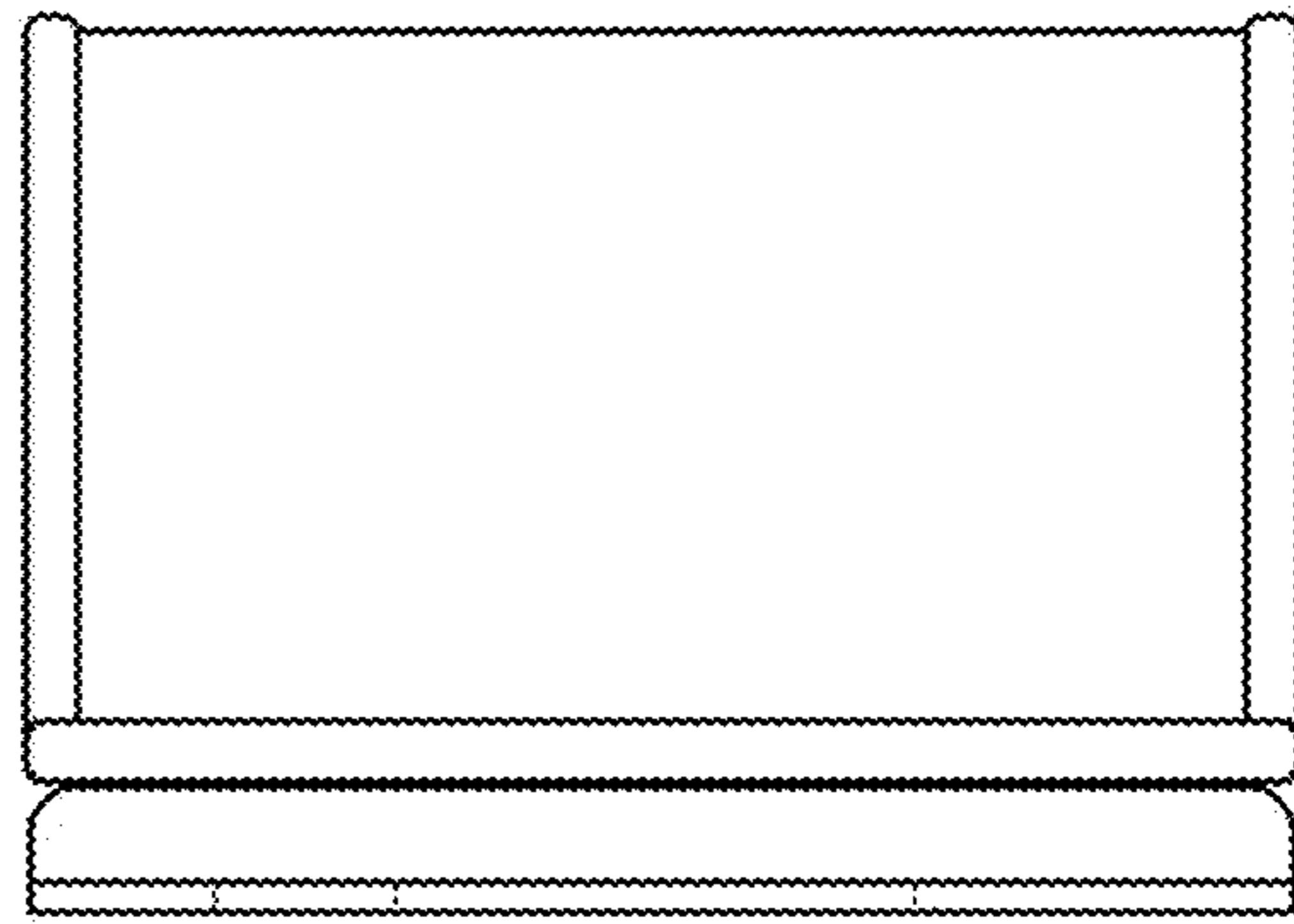

1.3

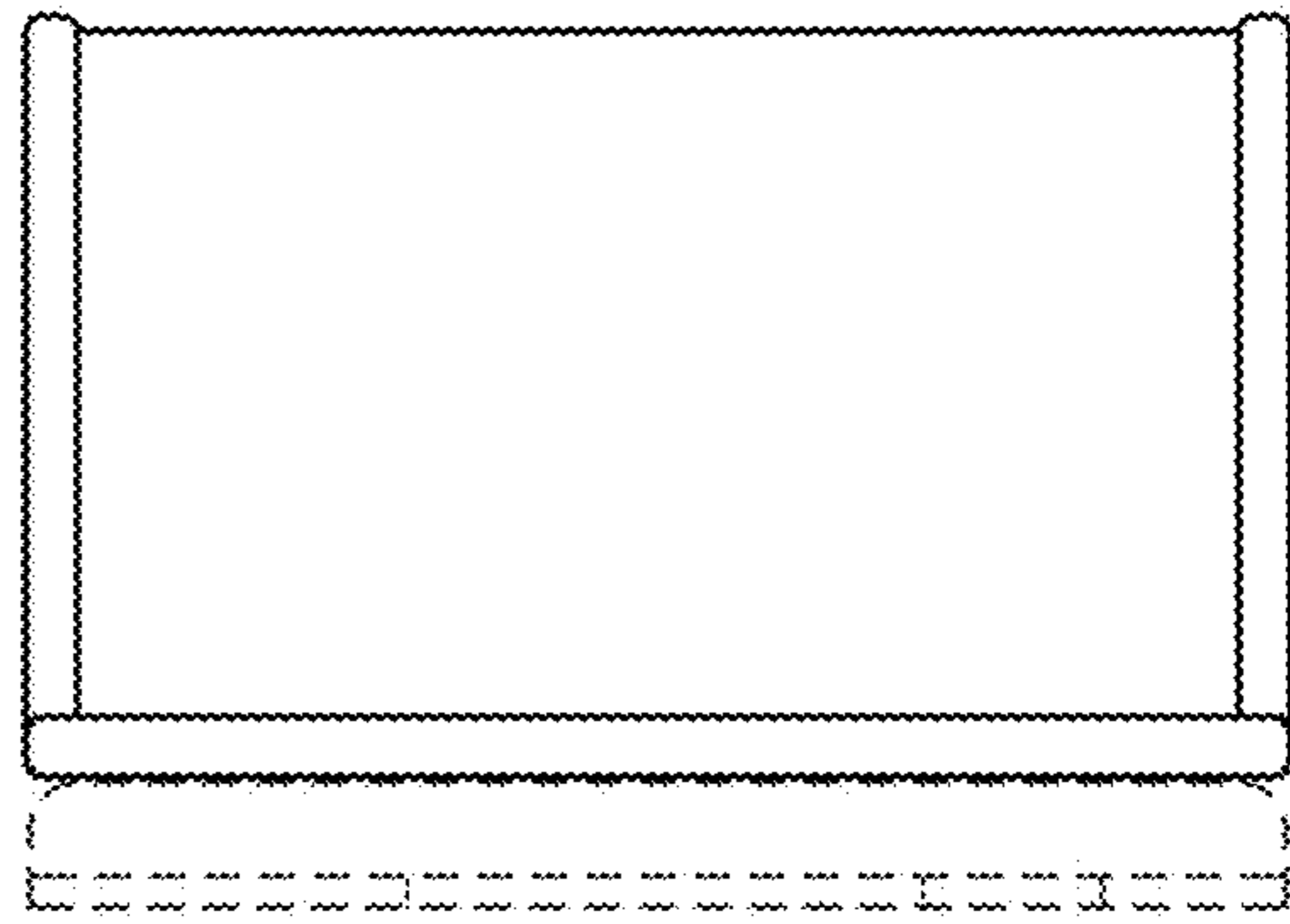

1.4

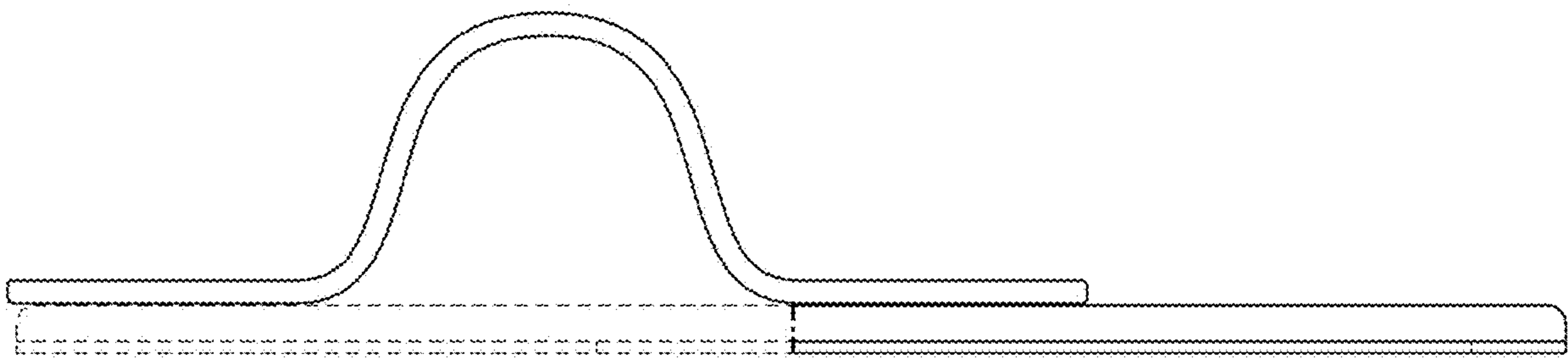

1.5

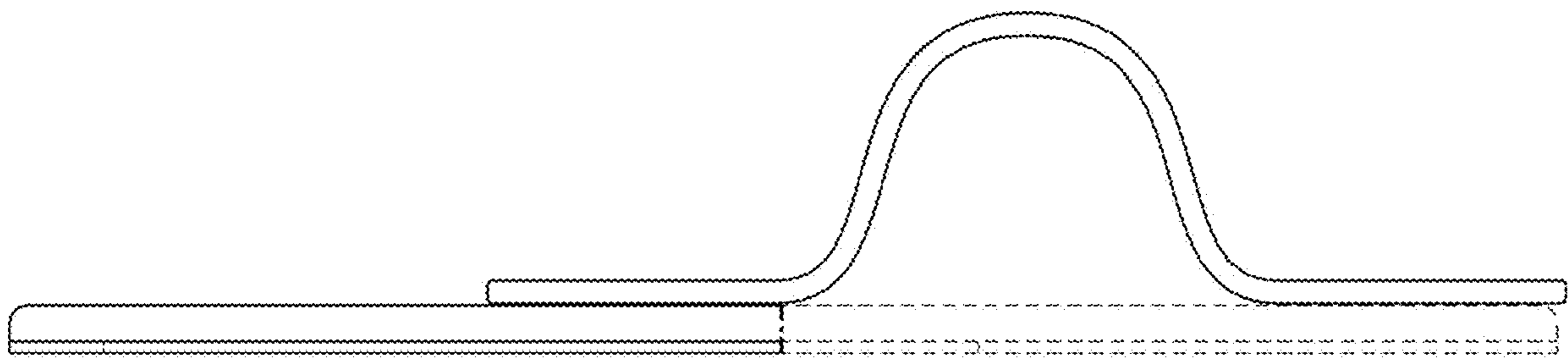

1.6

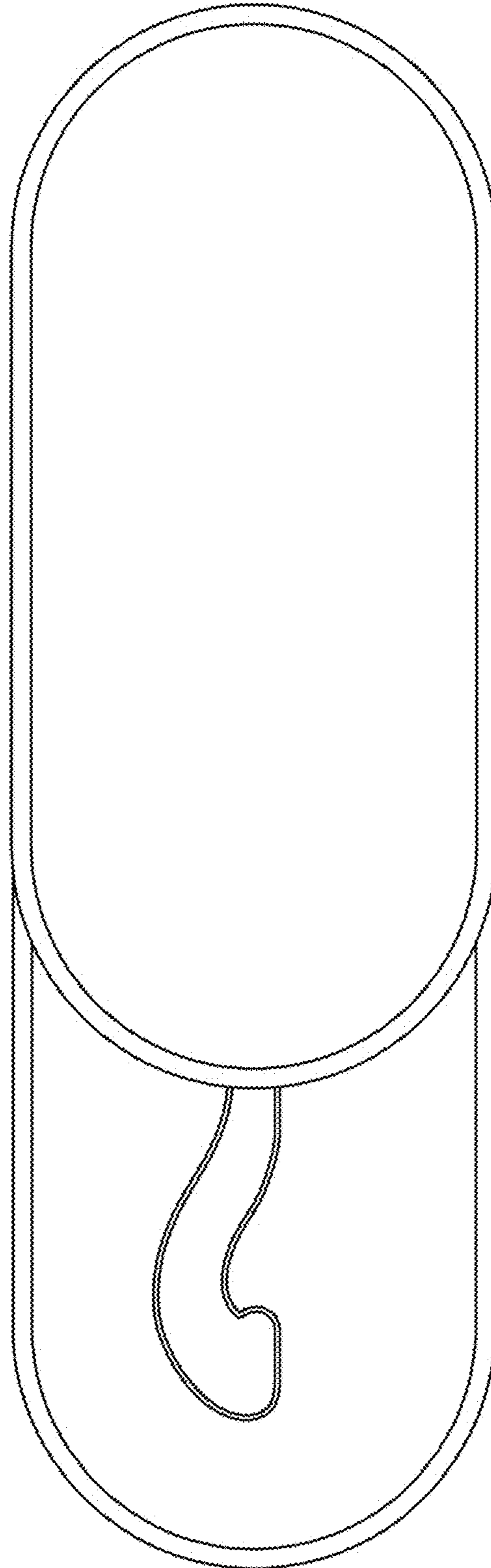

1.7

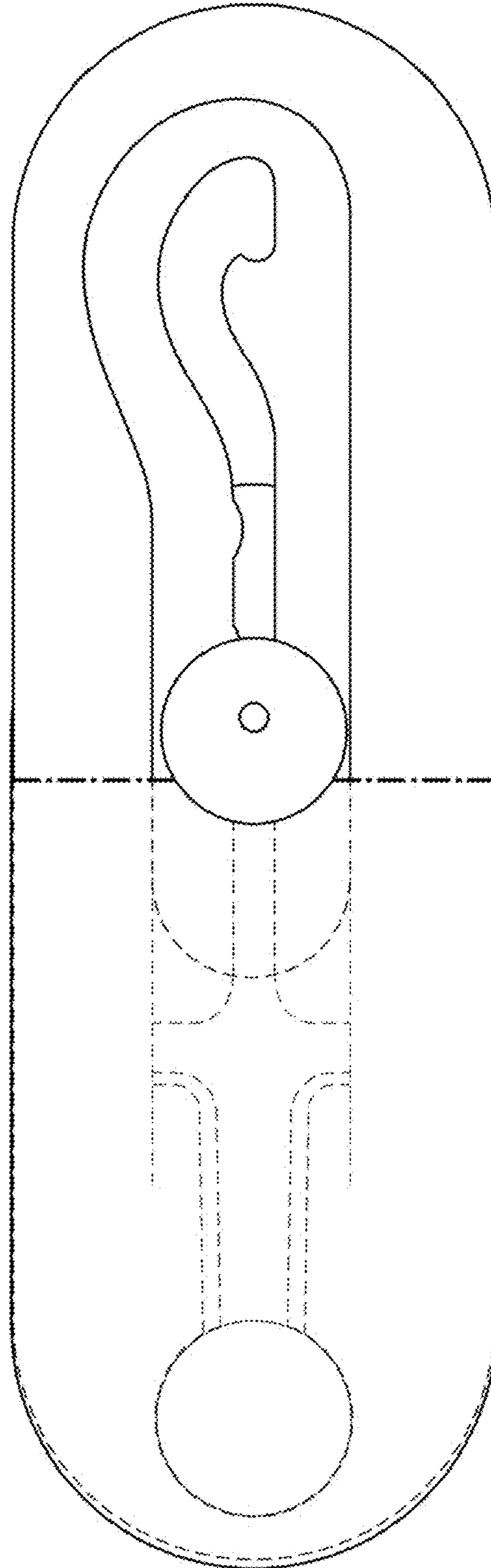

1.8

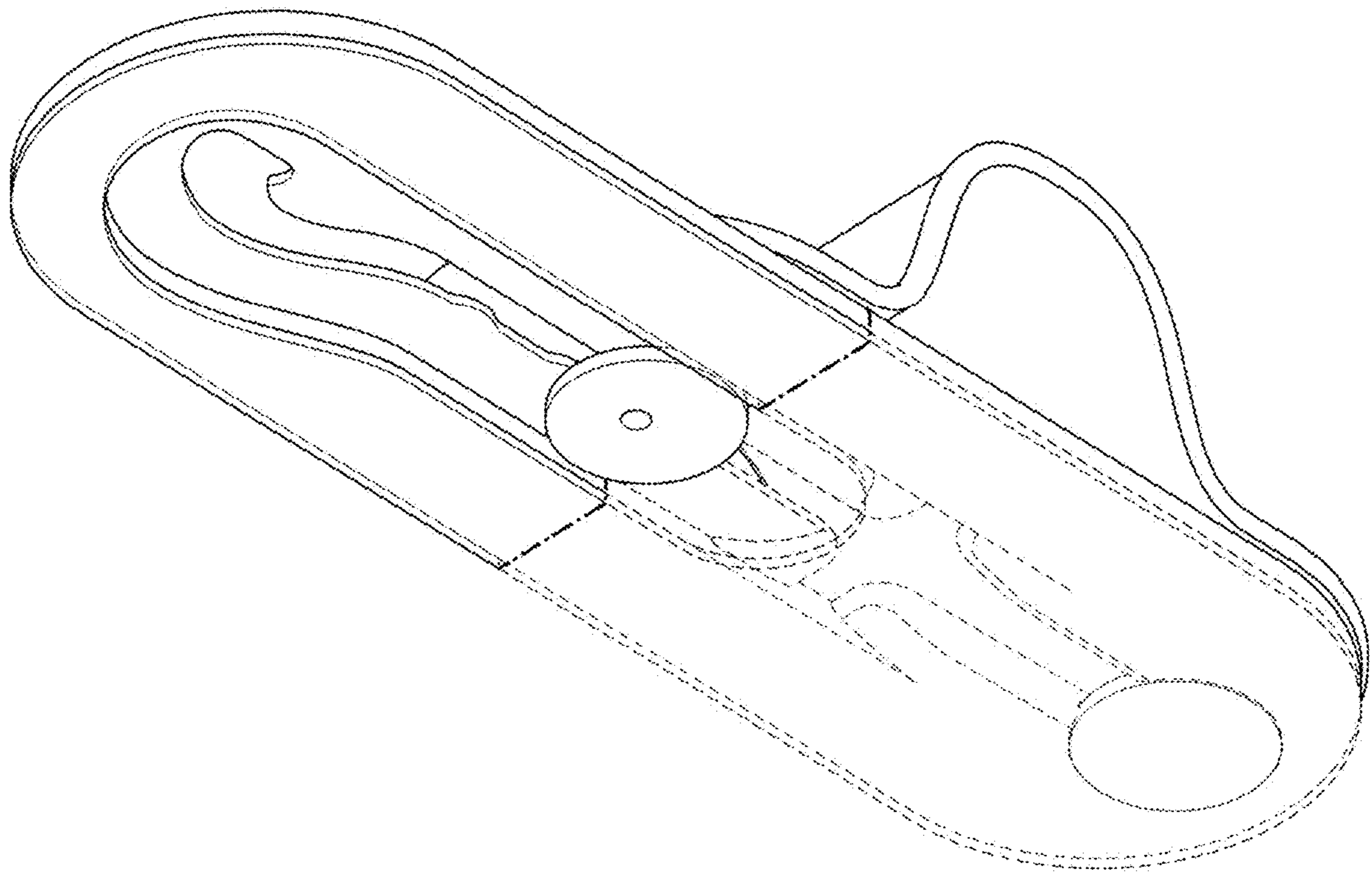

1.9

