



US00D972522S

(12) **United States Design Patent** (10) **Patent No.:** **US D972,522 S**
Hung (45) **Date of Patent:** **** Dec. 13, 2022**

(54) **MOBILE PHONE**

FOREIGN PATENT DOCUMENTS

(71) Applicant: **HMD Global Oy**, Espoo (FI)

CN 306402468 * 3/2021
WO WOD213515-001 * 4/2021

(72) Inventor: **Cheng-Li Hung**, Tainan (TW)

(73) Assignee: **HMD Global Oy**, Espoo (FI)

(**) Term: **15 Years**

(21) Appl. No.: **29/750,594**

(22) Filed: **Sep. 15, 2020**

(51) **LOC (13) Cl.** **14-03**

(52) **U.S. Cl.**

USPC **D14/138 G**

(58) **Field of Classification Search**

USPC D14/496, 138 R, 138 AA, 138 AB,
D14/138 AC, 138 AD, 138 C, 138 G,
D14/203.1, 203.3, 203.4, 203.7, 299;
D13/103, 107; D10/50

CPC G06F 3/041; G06F 3/0412; G06F 3/0488;
G06F 3/04883; G06F 1/1613; G06F
1/1686; G06F 1/1626; G06F 2200/1633;
H04M 1/0283; H04M 1/0279; H04M
1/0202; H04M 1/0266; H04M 1/027

See application file for complete search history.

(56) **References Cited**

U.S. PATENT DOCUMENTS

D697,887 S * 1/2014 Yin D14/138 G
D716,279 S * 10/2014 Ou D14/248
D815,633 S * 4/2018 Akana D14/341
D818,498 S * 5/2018 Akana D14/511
D829,679 S * 10/2018 Cho D14/138 G
D831,015 S * 10/2018 Choe D14/248
D898,692 S * 10/2020 Lee D14/138 AD
D929,357 S * 8/2021 Guo D14/138 G

OTHER PUBLICATIONS

Nokia 6.2, www.amazon.com, Oct. 14, 2019. <https://www.amazon.com/Nokia-6-2-Unlocked-Smartphone-T-Mobile/dp/B07XW28MHX?th=1> (Year: 2019).*

Nokia 8 V 5G UW review, www.tomsguide.com, Nov. 12, 2020. <https://www.tomsguide.com/reviews/nokia-8-v-5g-uw-review> (Year: 2020).*

(Continued)

Primary Examiner — Llorellys Martinez

Assistant Examiner — Kwabena A. Ankobiah

(74) *Attorney, Agent, or Firm* — ScienBiziP, P.C.

(57) **CLAIM**

The ornamental design for a mobile phone, as shown and described.

DESCRIPTION

FIG. 1 is a front perspective view of a mobile phone showing my design.

FIG. 2 is a bottom rear perspective view of the mobile phone.

FIG. 3 is a front elevation view thereof.

FIG. 4 is a rear elevation view thereof.

FIG. 5 is a left side elevation view thereof.

FIG. 6 is a right side elevation view thereof.

FIG. 7 is a top plan view thereof.

FIG. 8 is a bottom plan view thereof; and,

FIG. 9 is an enlarged view thereof, taken from encircled portion 9 in FIG. 1.

The broken lines in the drawings illustrate portions of the mobile phone, that form no part of the claimed design. The dash-dot broken lines in FIGS. 1 and 9 encircling a portion of the mobile phone form no part of the claimed design.

1 Claim, 9 Drawing Sheets

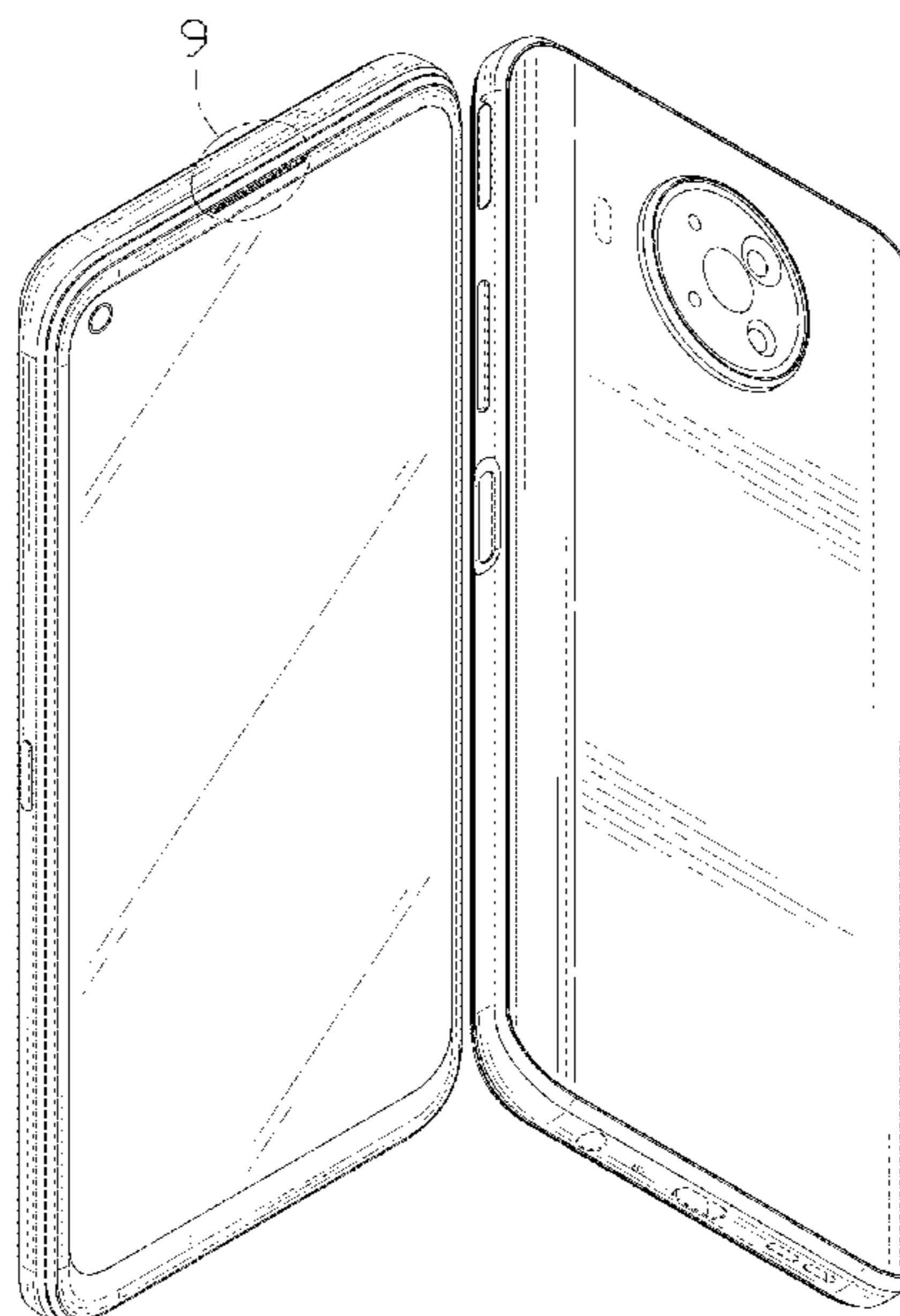

(56)

References Cited

OTHER PUBLICATIONS

Nokia 8 V 5G UW Unboxing, www.youtube.com, Nov. 10, 2020.

<https://www.youtube.com/watch?v=NAahiZOqS24> (Year: 2020).*

Nokia 8.3 5G review:, www.pocket-lint.com, Sep. 22, 2020. <https://www.pocket-lint.com/phones/reviews/nokia/153887-nokia-8-3-5g-review> (Year: 2020).*

* cited by examiner

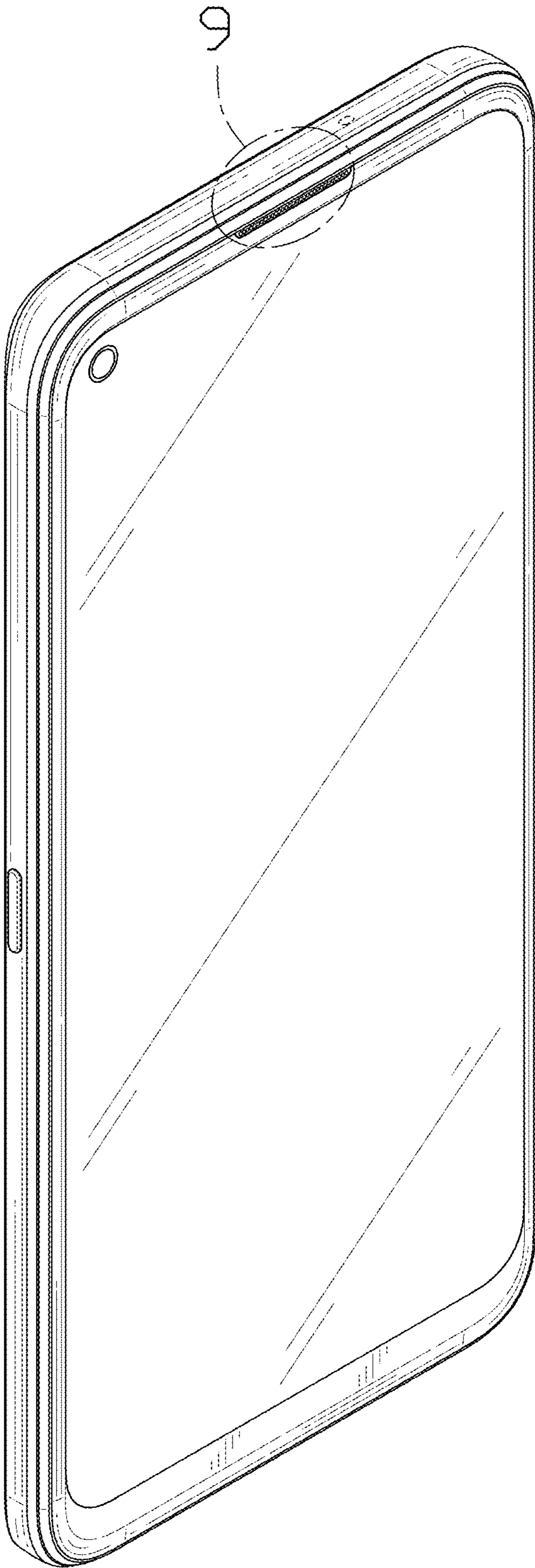

FIG. 1

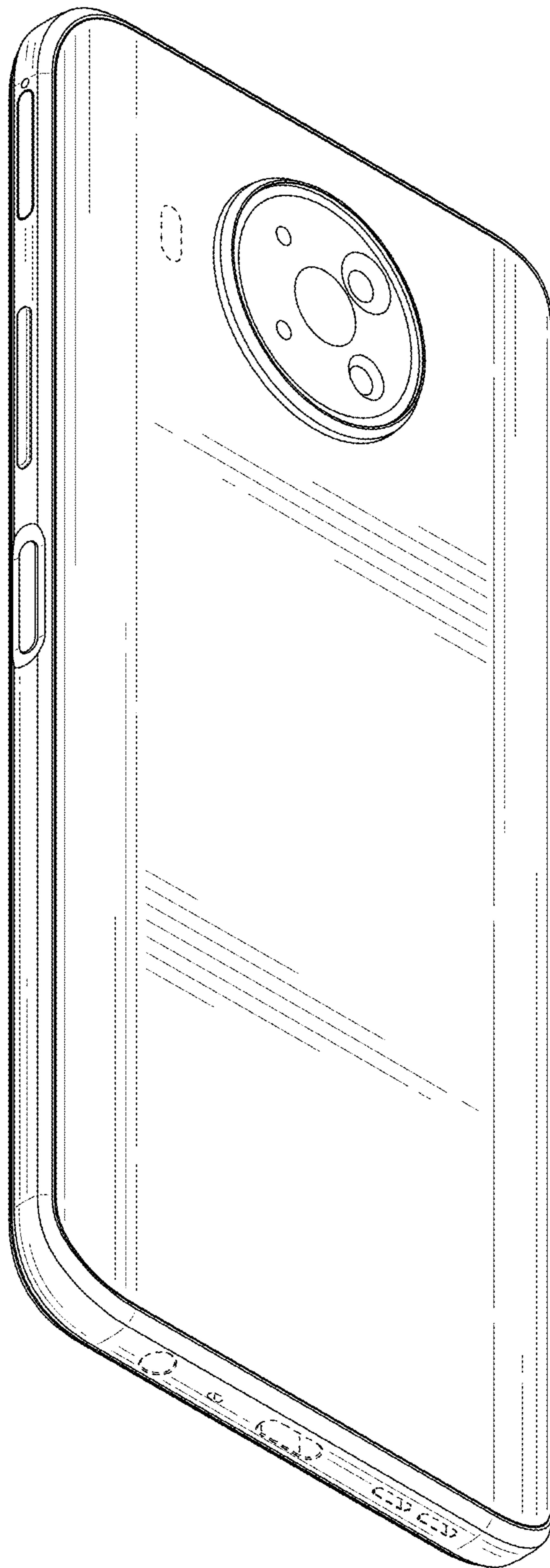

FIG. 2

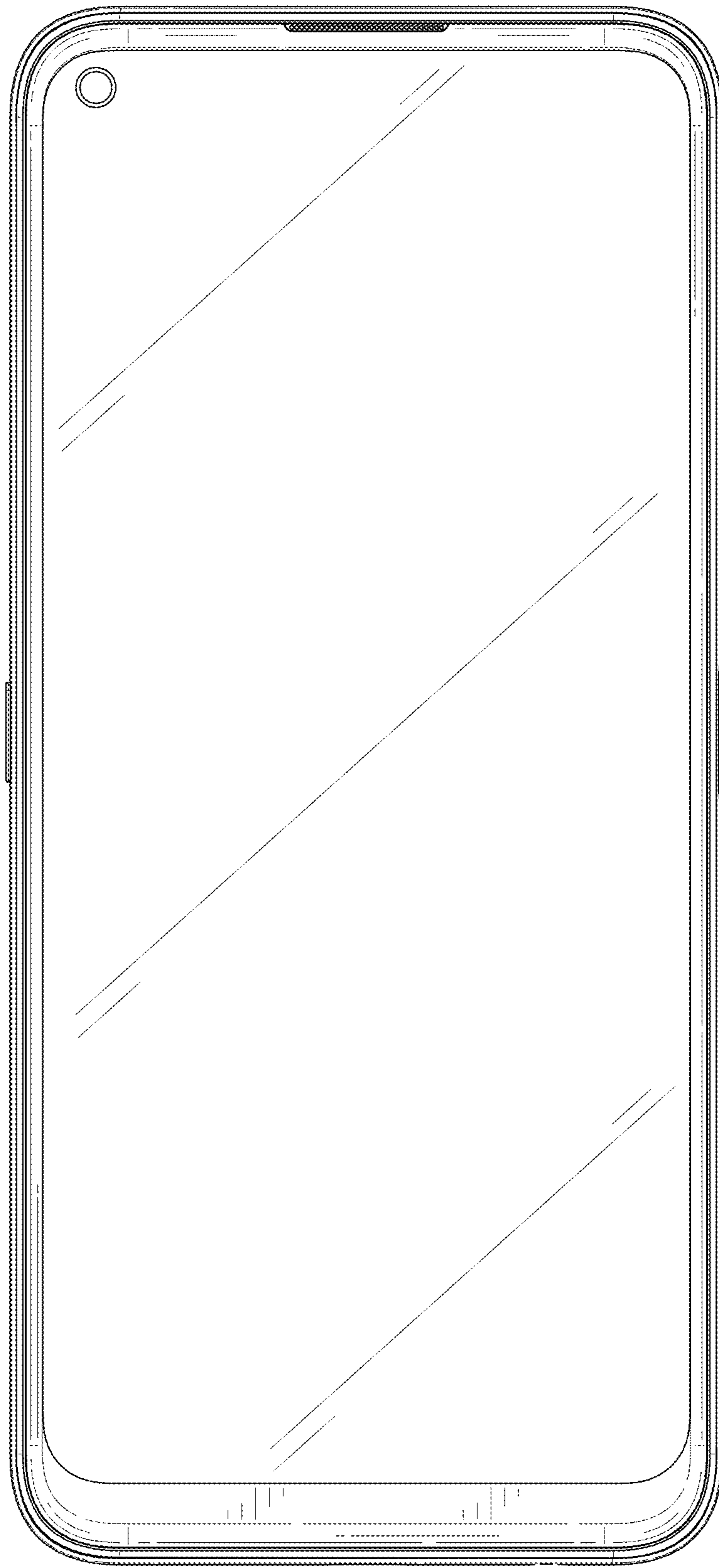

FIG. 3

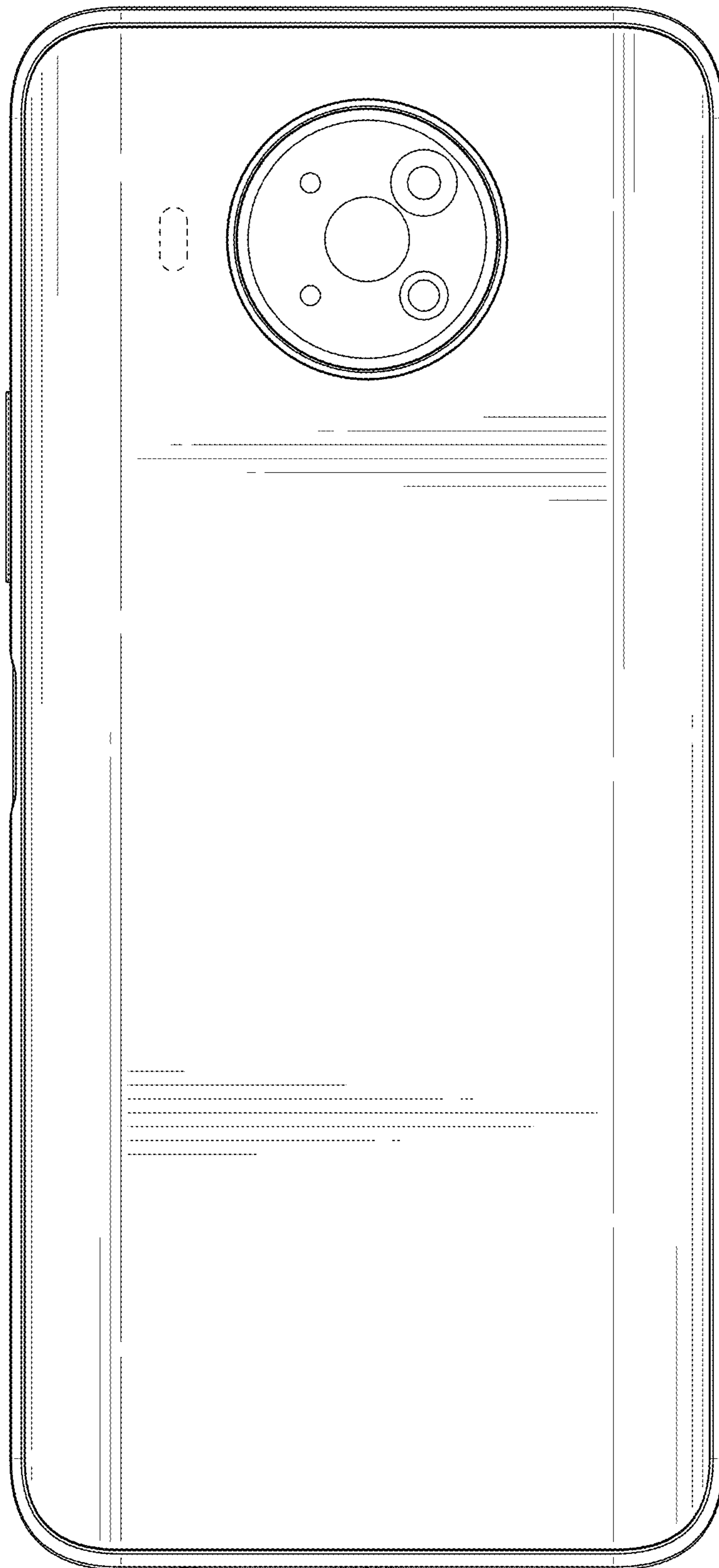

FIG. 4

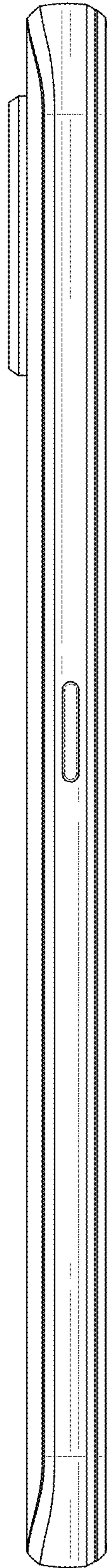

FIG. 5

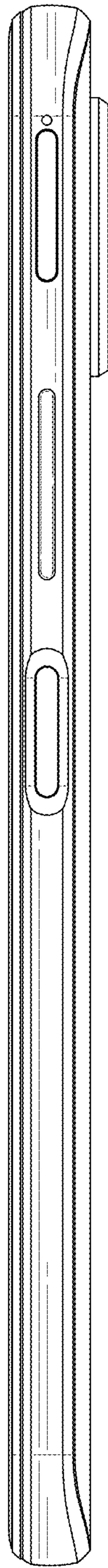

FIG. 6

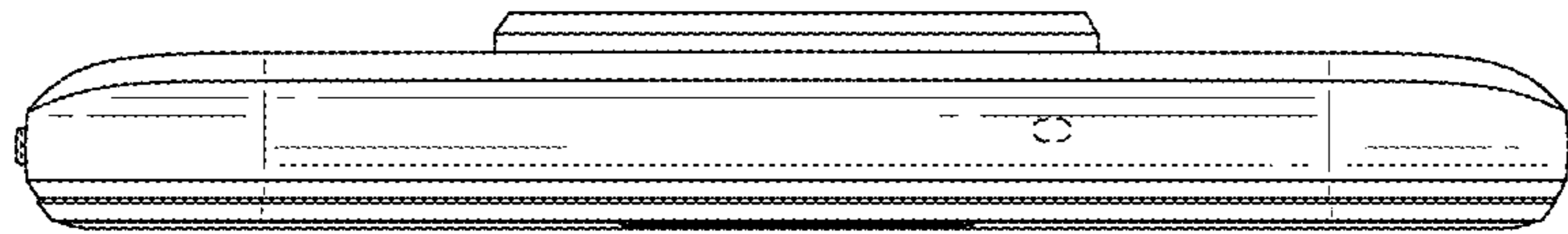

FIG. 7

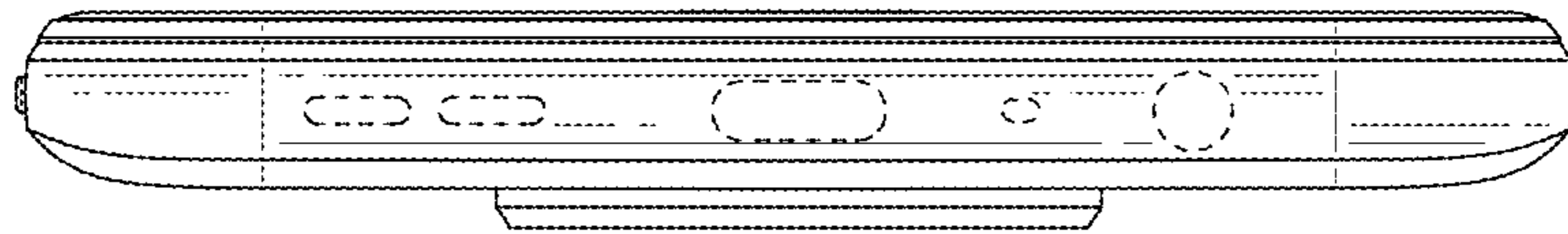

FIG. 8

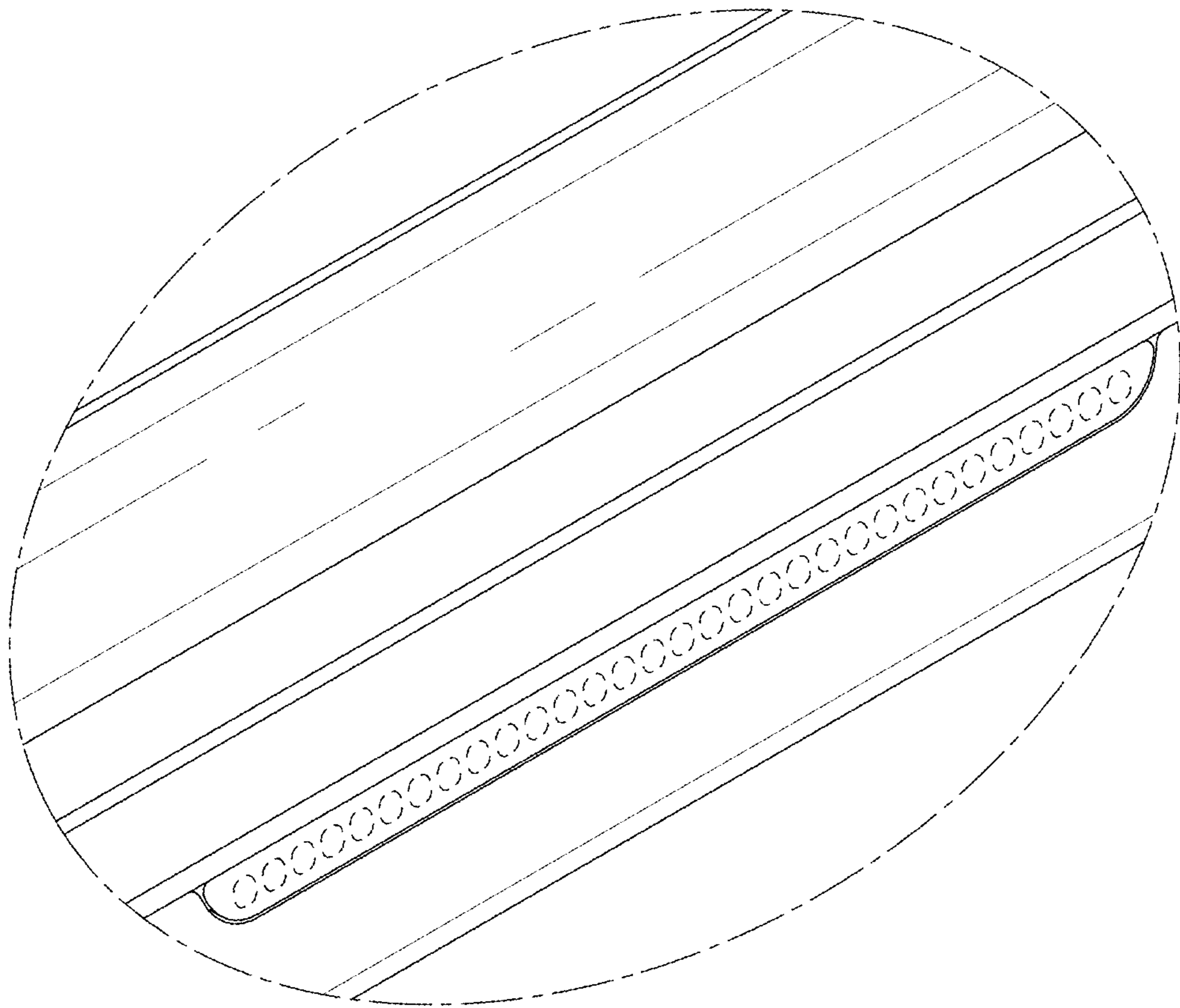

FIG. 9

UNITED STATES PATENT AND TRADEMARK OFFICE
CERTIFICATE OF CORRECTION

PATENT NO. : D972,522 S
APPLICATION NO. : 29/750594
DATED : December 13, 2022
INVENTOR(S) : Cheng-Li Hung

Page 1 of 1

It is certified that error appears in the above-identified patent and that said Letters Patent is hereby corrected as shown below:

On the Title Page

Column 1, Please add Item (30) regarding "Foreign Application Priority Data" with the following:

(30) Foreign Application Priority Data

Mar. 17, 2020 (EM) 007757745-0001

Signed and Sealed this
Twenty-third Day of May, 2023
Katherine Kelly Vidal

Katherine Kelly Vidal
Director of the United States Patent and Trademark Office