



US00D972445S

(12) **United States Design Patent**  
**Yatsugi-Kang**

(10) **Patent No.:** **US D972,445 S**

(45) **Date of Patent:** **\*\* Dec. 13, 2022**

- (54) **RING**
- (71) Applicant: **Harry Winston SA**, Plan-les-Ouates (CH)
- (72) Inventor: **Rie Yatsugi-Kang**, New York, NY (US)
- (73) Assignee: **Harry Winston SA**, Plan-les-Ouates (CH)

2,763,140 A *	9/1956	Lutrario .....	A44C 9/00 63/27
D747,657 S *	1/2016	Abdourahim .....	D10/38
D791,637 S *	7/2017	Yatsugi-Kang .....	D11/34
D875,593 S *	2/2020	Yatsugi-Kang .....	D11/42
D877,644 S *	3/2020	Yatsugi-Kang .....	D11/34
D938,852 S *	12/2021	Riviere .....	D11/34
D942,303 S *	2/2022	Yatsugi-Kang .....	D11/34
D946,458 S *	3/2022	Riviere .....	D11/34
D953,921 S *	6/2022	Yatsugi-Kang .....	D11/34

- (\*\*) Term: **15 Years**
- (21) Appl. No.: **29/798,879**
- (22) Filed: **Jul. 12, 2021**

(30) **Foreign Application Priority Data**  
 Jan. 21, 2021 (WO) ..... WIPO101186

(51) **LOC (13) Cl.** ..... **11-01**  
 (52) **U.S. Cl.**  
 USPC ..... **D11/34**

(58) **Field of Classification Search**  
 USPC ..... D11/1, 7, 8, 26-39, 79, 91, 92  
 CPC ..... A44C 9/00; A44C 9/0007; A44C 9/0014;  
 A44C 9/0023; A44C 9/003; A44C  
 9/0038; A44C 9/0046; A44C 9/0053;  
 A44C 9/0061; A44C 9/0069; A44C  
 9/0076; A44C 9/0084; A44C 9/0092;  
 A44C 9/02; A44C 17/0258; A44C  
 17/0266; A44C 17/0275; A44C 17/0283;  
 A44C 17/02; A44C 17/0208; A44C  
 17/0216; A44C 17/0225; A44C 17/0233;  
 A44C 17/0241; A44C 17/025; A44C  
 17/0288; A44C 17/0291; A44C 1/00;  
 A44C 15/00; A44C 15/0005; A44C  
 15/001; A44C 15/005  
 See application file for complete search history.

(56) **References Cited**  
 U.S. PATENT DOCUMENTS  
 D79,258 S \* 8/1929 Sandler ..... D11/32  
 1,877,442 A \* 9/1932 Armstrong ..... A44C 17/04  
 63/26

**OTHER PUBLICATIONS**

[Online] <https://www.harrywinston.com/en/products/winston-candy/winston-candy-pink-spinel-ring-with-sapphires-tsavorite-garnets-and-diamonds-575867>. Retrieved Aug. 26, 2022.\*  
 [Online] <https://mlchicagosocial.com/harry-winston-bridal-couture-engagement-ring-collection-chicago>. Retrieved Aug. 26, 2022.\*

\* cited by examiner

*Primary Examiner* — Melanie Pellegrini  
 (74) *Attorney, Agent, or Firm* — Blank Rome LLP

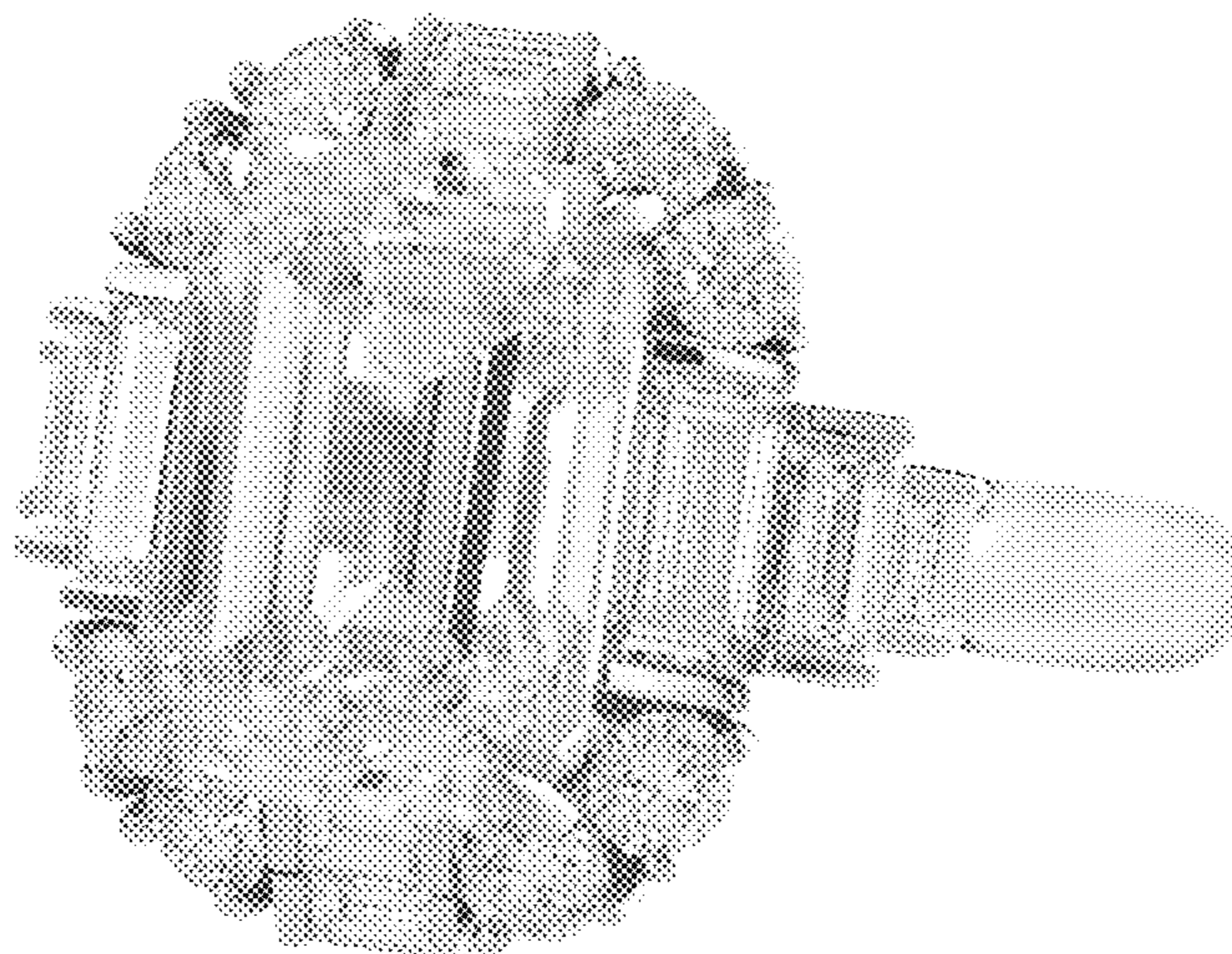
(57) **CLAIM**

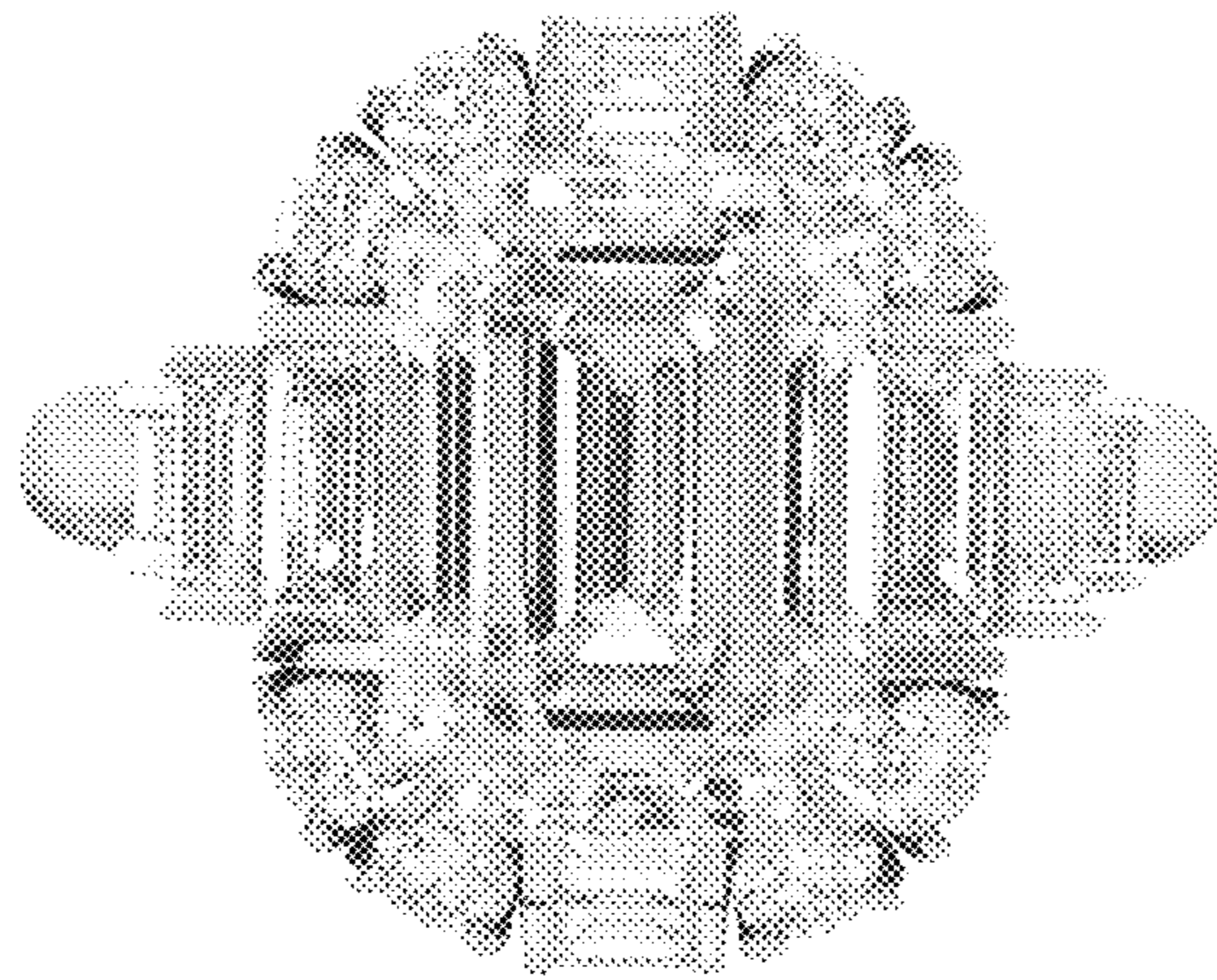
The ornamental design for a ring, as shown and described.

**DESCRIPTION**

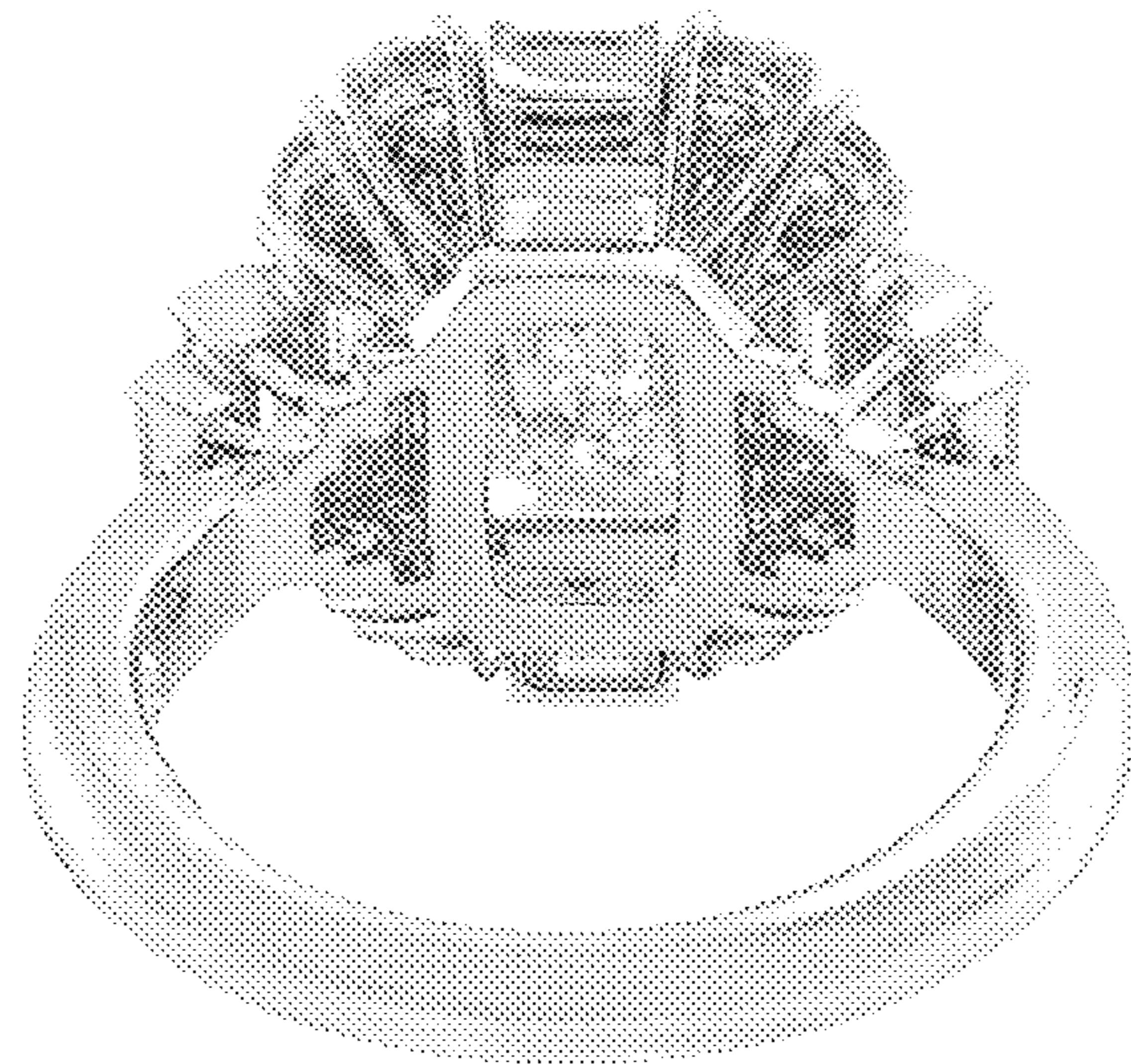
FIG. 1 is a top view of a ring of my new design;  
 FIG. 2 is a bottom perspective view thereof;  
 FIG. 3 is a right side view thereof;  
 FIG. 4 is a left side view thereof;  
 FIG. 5 is a front view thereof;  
 FIG. 6 is a rear view thereof;  
 FIG. 7 is a top right perspective view thereof; and,  
 FIG. 8 is a bottom left perspective view thereof.

**1 Claim, 8 Drawing Sheets**

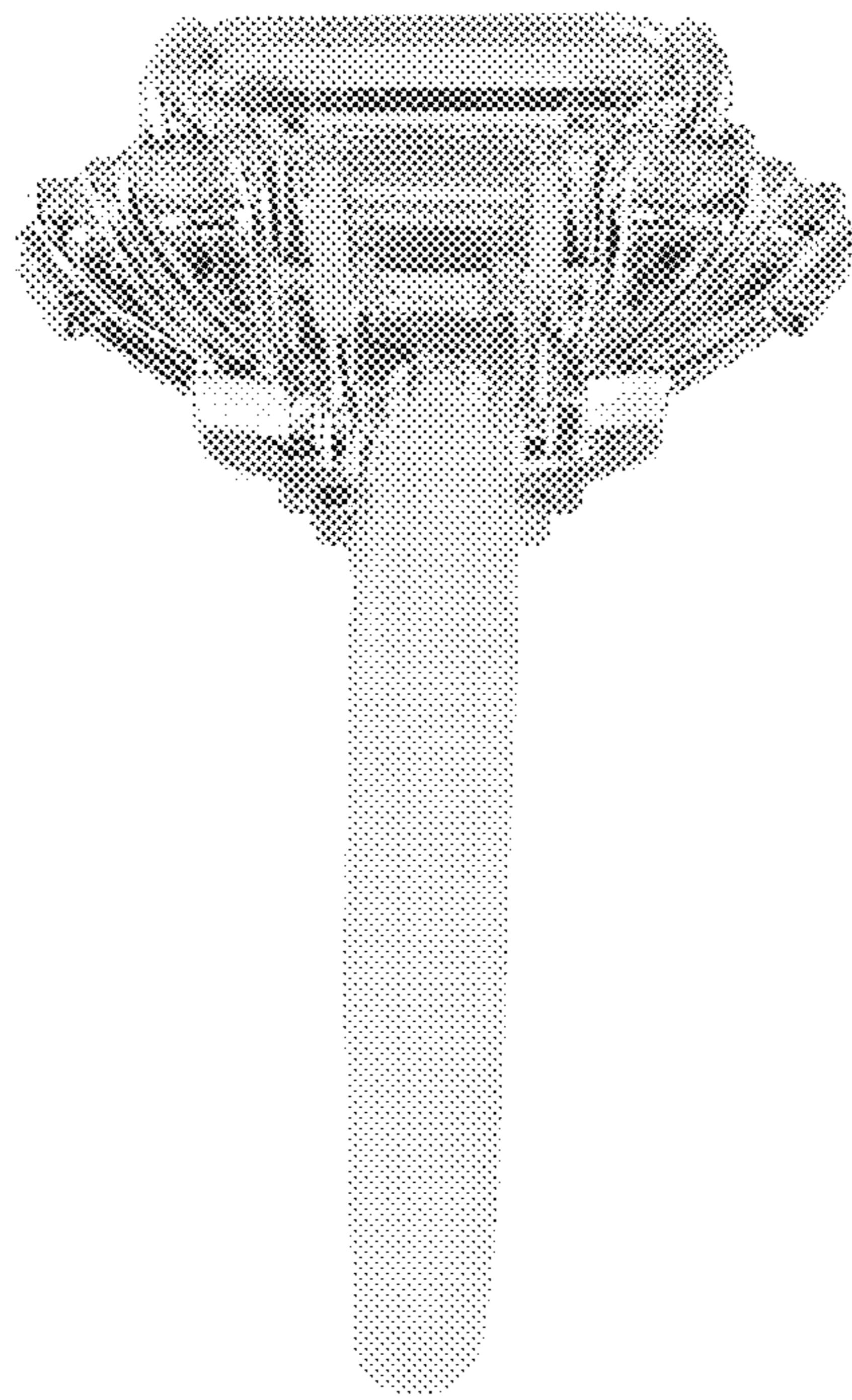




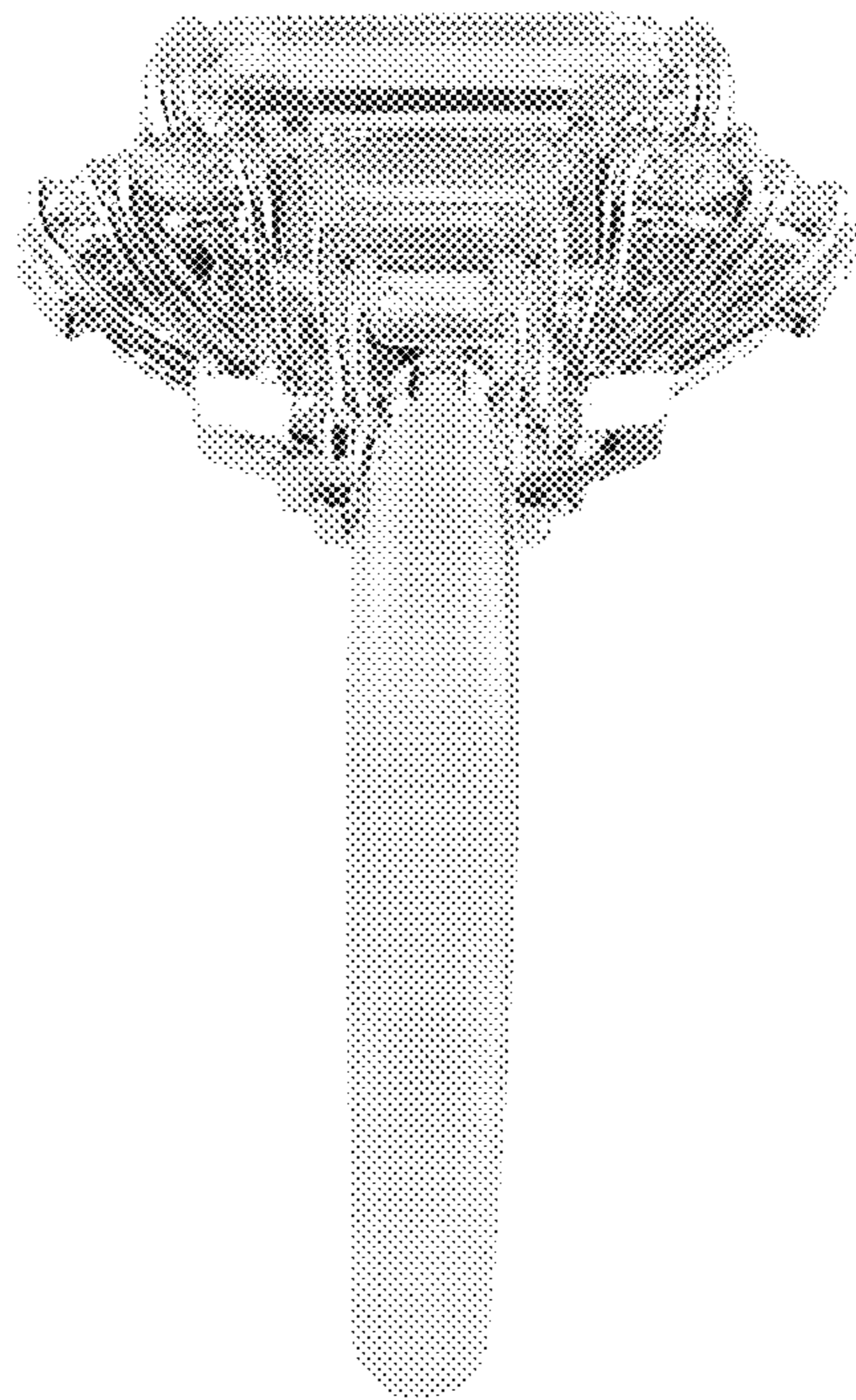
***FIG. 1***



**FIG. 2**



**FIG. 3**



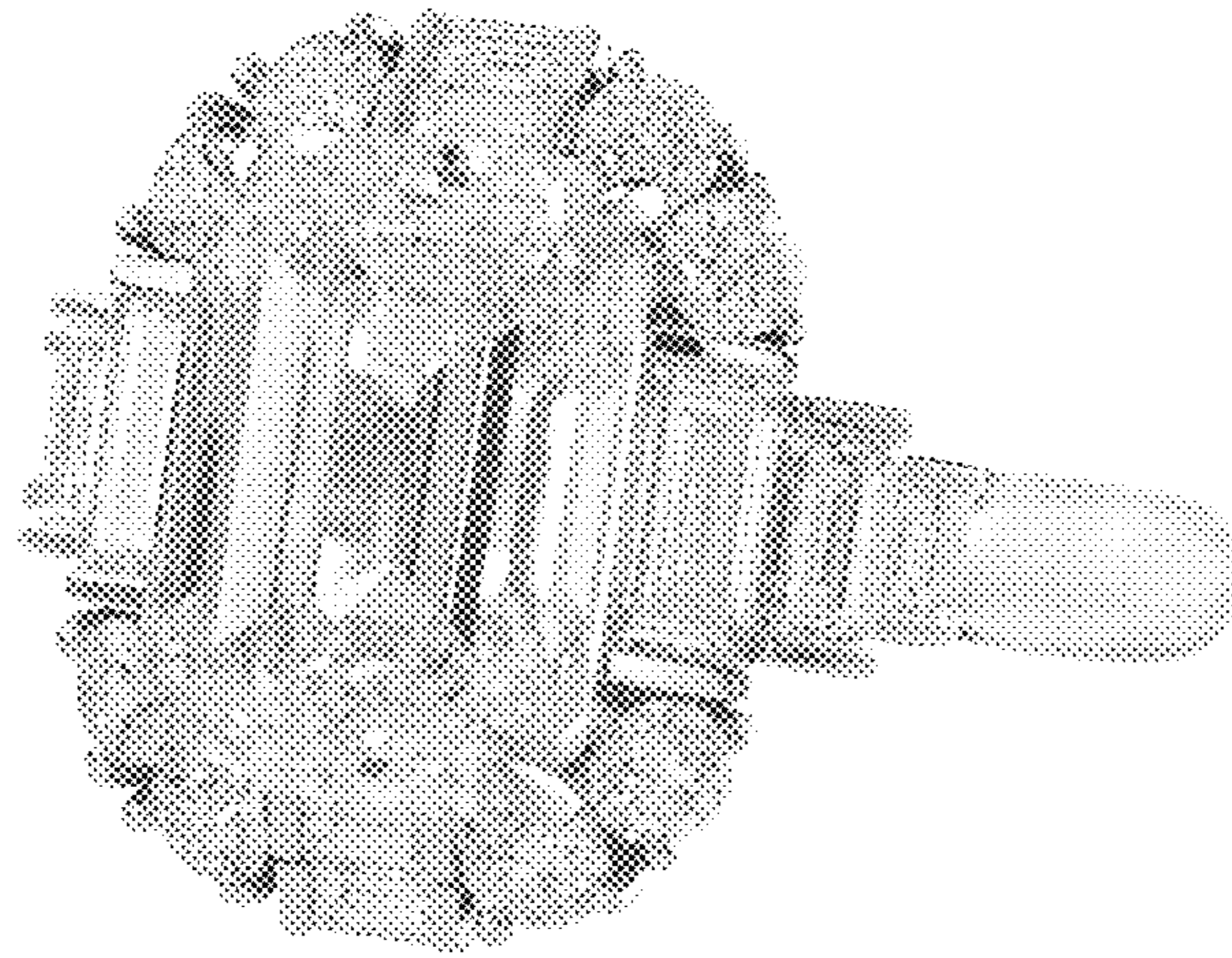
**FIG. 4**



**FIG. 5**

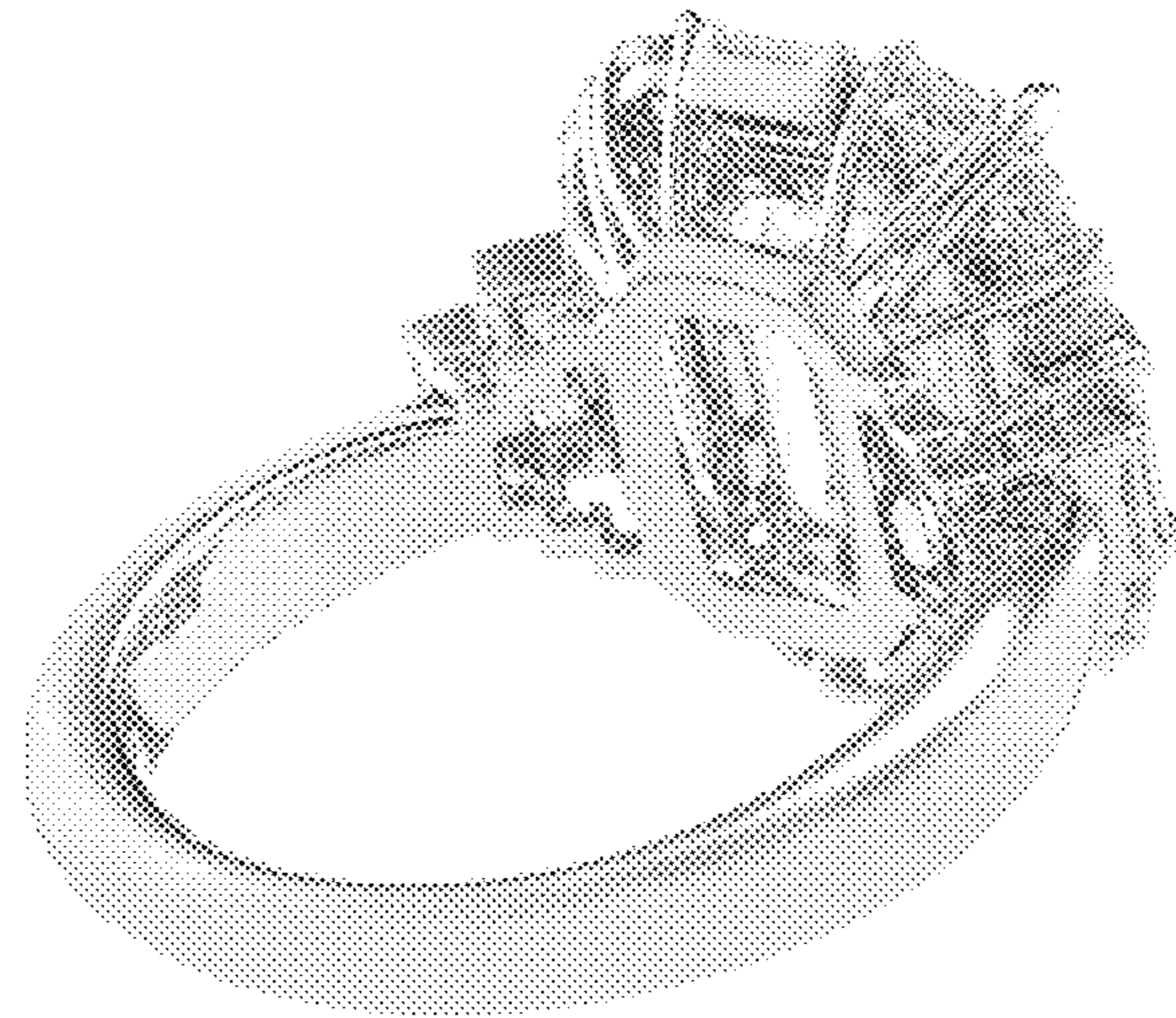


**FIG. 6**



***FIG. 7***





**FIG. 8**