



US00D972429S

(12) **United States Design Patent**
Sirichai

(10) **Patent No.:** **US D972,429 S**

(45) **Date of Patent:** **** Dec. 13, 2022**

(54) **BAND ASSEMBLY**

DESCRIPTION

(71) Applicant: **Saharut Sirichai**, Bangkok (TH)

(72) Inventor: **Saharut Sirichai**, Bangkok (TH)

(73) Assignee: **World Richman Manufacturing Corporation**, Elgin, IL (US)

(**) Term: **15 Years**

(21) Appl. No.: **29/712,219**

(22) Filed: **Nov. 6, 2019**

(51) **LOC (13) Cl.** **11-01**

(52) **U.S. Cl.**
USPC **D11/3**

(58) **Field of Classification Search**

USPC D11/1-3; D10/31, 32; D14/344;
D2/624, 626, 627, 634, 635, 638;
D30/152, 153

CPC A44C 5/00; A44C 5/0053; A44C 5/0069;
A44C 5/16; A44C 5/20

See application file for complete search history.

(56) **References Cited**

U.S. PATENT DOCUMENTS

1,626,160	A *	4/1927	Schwalberg	A44C 5/16 224/178
4,509,214	A *	4/1985	Shea	A41F 9/002 D2/627
D346,482	S *	5/1994	Merrill	D2/627
D393,337	S *	4/1998	Seki	D2/624
D457,688	S *	5/2002	Cordero	D2/627
D488,912	S *	4/2004	Berger	D2/627
D676,627	S *	2/2013	Doss	D2/624

(Continued)

Primary Examiner — Llorellys Martinez

(74) *Attorney, Agent, or Firm* — Christopher J. Scott

(57) **CLAIM**

The ornamental design for a band assembly, as shown and described.

FIG. 1 is a front perspective view of a band assembly showing my new design.

FIG. 2 is a rear perspective view thereof.

FIG. 3 is a front elevation view thereof.

FIG. 4 is a rear elevation view thereof.

FIG. 5 is a front perspective view of the band portion of the band assembly, shown separately to show aspects of the design that are not visible when combined.

FIG. 6 is a rear perspective view thereof.

FIG. 7 is a front elevation view thereof.

FIG. 8 is a rear elevation view thereof.

FIG. 9 is an end view of the band assembly of FIG. 1.

FIG. 10 is a side elevation view thereof.

FIG. 11 is an opposite side elevation view thereof.

FIG. 12 is an opposite end view thereof.

FIG. 13 is an end view of the band portion of the band assembly of FIG. 5.

FIG. 14 is a side elevation view thereof.

FIG. 15 is an opposite side elevation view thereof.

FIG. 16 is an opposite end view thereof.

FIG. 17 is a detailed view of the lug portion of the band assembly, taken from line 17 in FIG. 4, wherein the lug portion is shown separately to show aspects of the design that are not visible when combined.

FIG. 18 is a side perspective view thereof.

FIG. 19 is an end view thereof.

FIG. 20 is a top side view thereof.

FIG. 21 is a side view thereof.

FIG. 22 is an opposite side view thereof.

FIG. 23 is a bottom view thereof; and,

FIG. 24 is an opposite end view thereof.

The broken lines in the drawings represent portions of the band assembly that form no part of the claimed design.

The dot-dash broken lines of FIGS. 4 and 17 are included to show a partially enlarged view only and form no part of the claimed design.

1 Claim, 7 Drawing Sheets

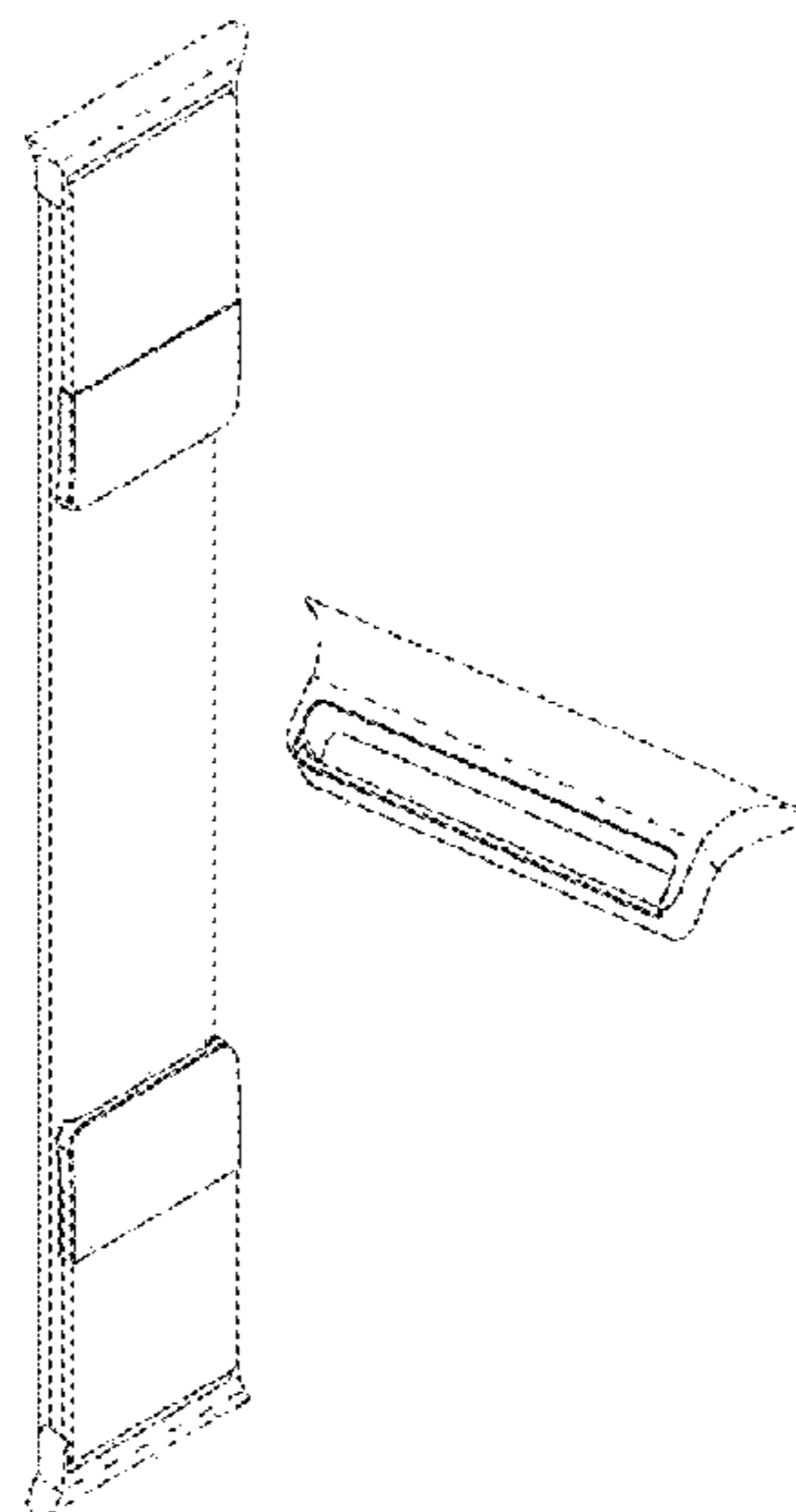

(56)

References Cited

U.S. PATENT DOCUMENTS

D707,917	S *	7/2014	James	A41F 9/002 D2/627
D790,382	S *	6/2017	Sasson	D11/3
D857,543	S *	8/2019	Sirichai	D11/3
D883,838	S *	5/2020	Deng	D11/3
D883,839	S *	5/2020	Deng	D11/3
D888,368	S *	6/2020	Hyera	D2/627
10,729,210	B1 *	8/2020	Sano	A44C 5/0053
D897,882	S *	10/2020	Yi	D11/3
D918,759	S *	5/2021	Liu	D11/3
11,033,083	B1 *	6/2021	Moustafa	G06F 1/163
2008/0223889	A1 *	9/2008	Rossell	A44C 5/0007 224/222
2015/0185764	A1 *	7/2015	Magi	G06F 1/163 361/679.03
2016/0278203	A1 *	9/2016	Nakayama	G06F 1/163
2016/0282899	A1 *	9/2016	Inagaki	G06F 1/163
2016/0299526	A1 *	10/2016	Inagaki	G06F 1/163

* cited by examiner

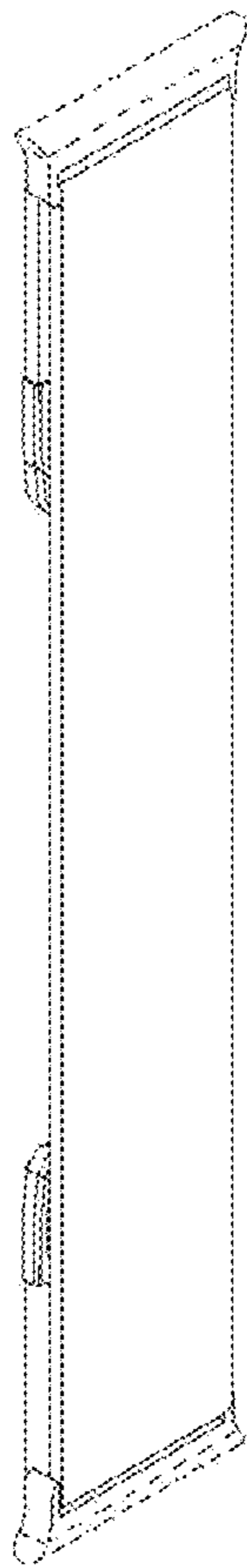

FIG. 1

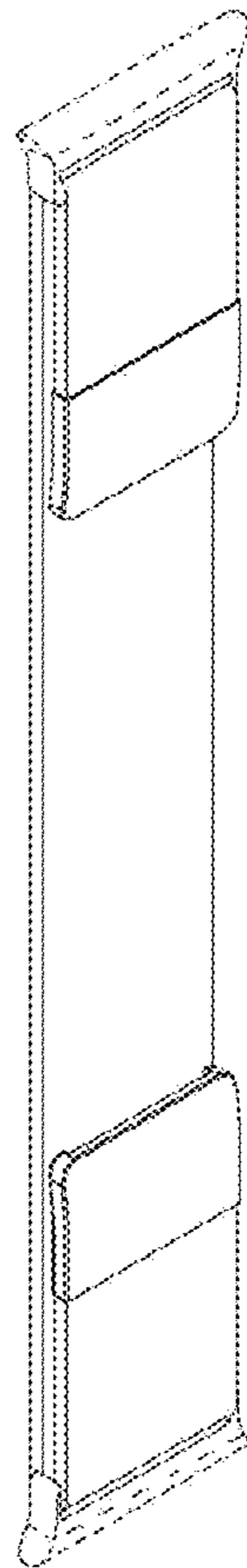

FIG. 2

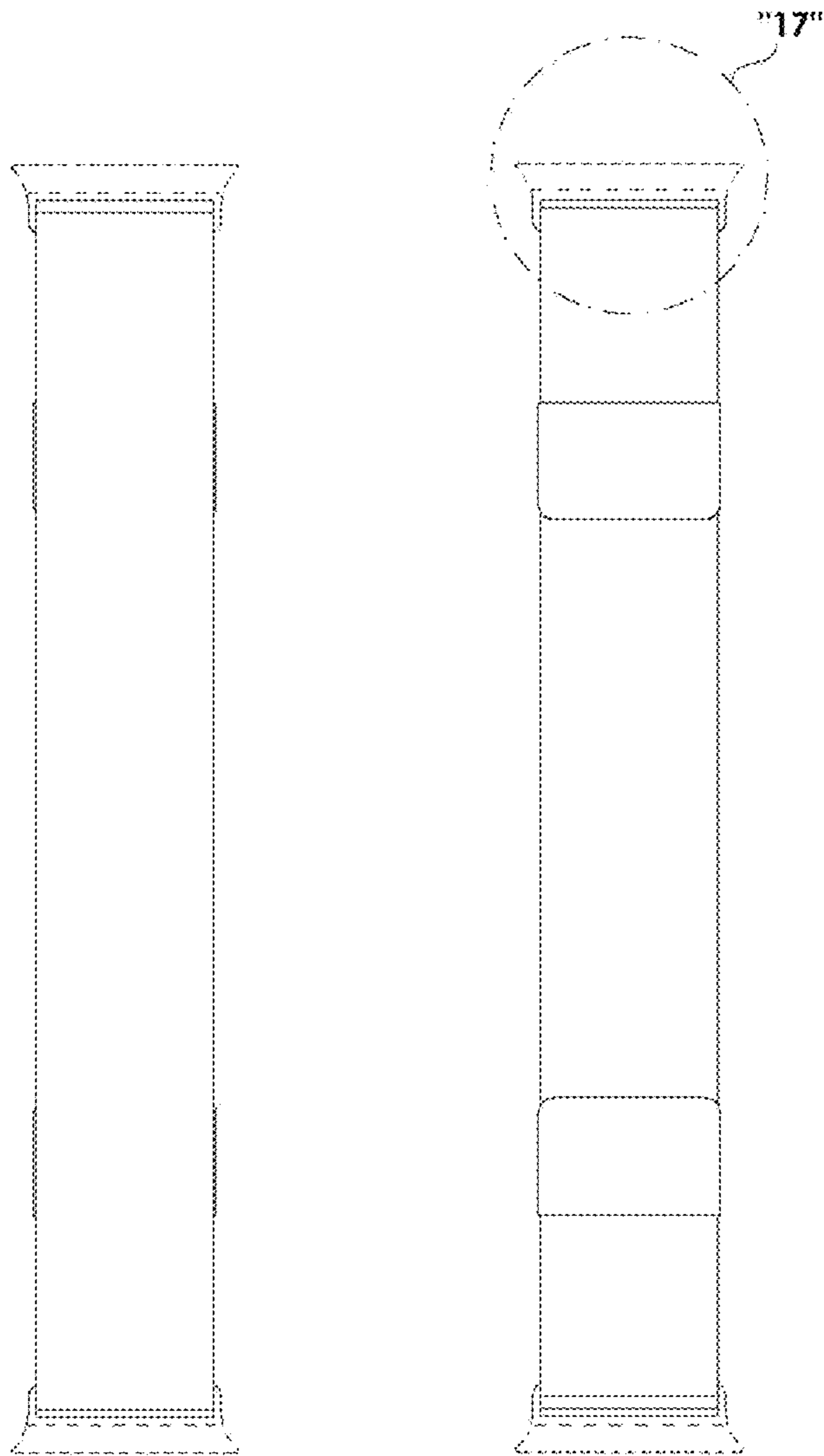

FIG.3

FIG.4

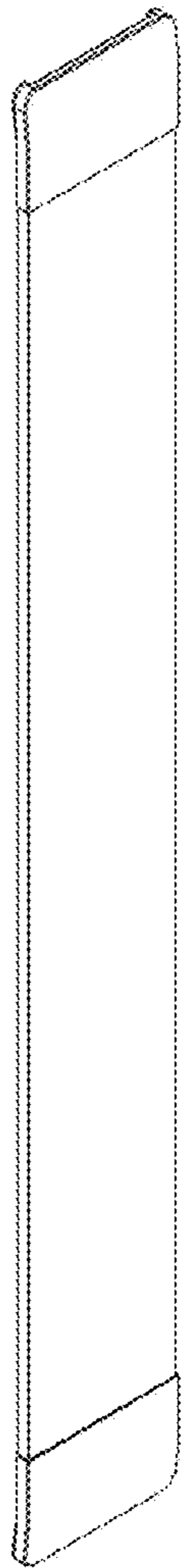

FIG. 5

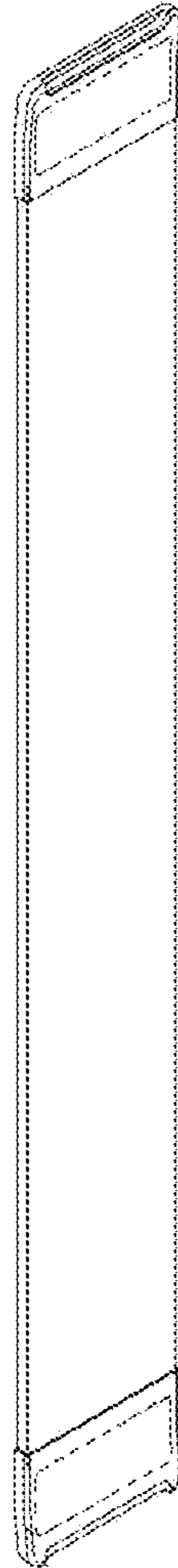

FIG. 6

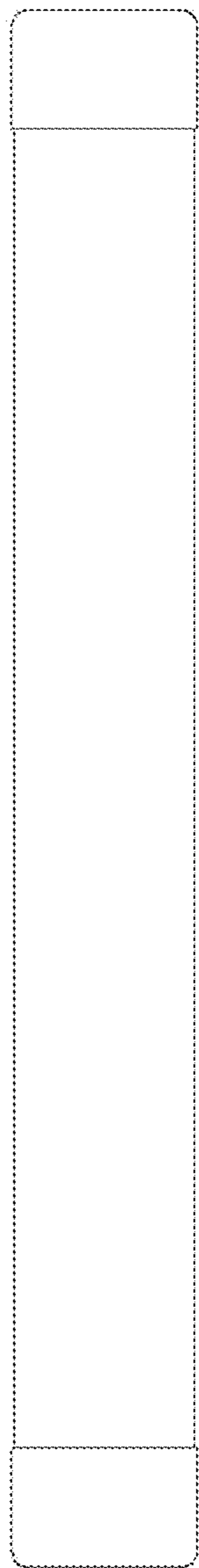

FIG. 7



FIG. 8

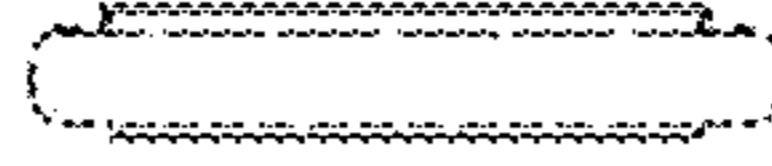

FIG. 9

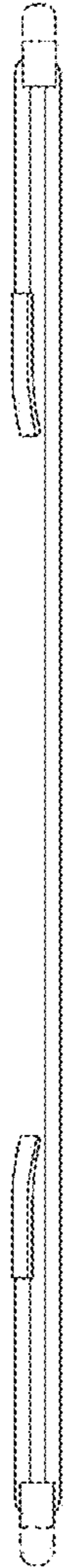

FIG. 10

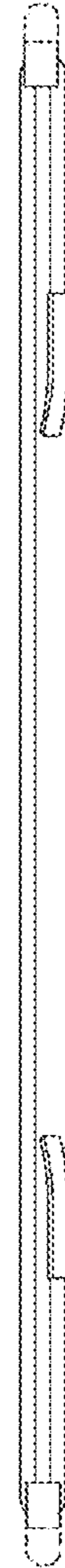

FIG. 11

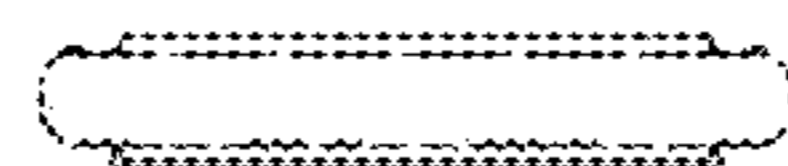

FIG. 12

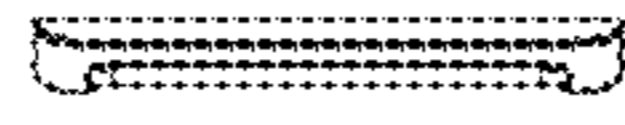

FIG. 13

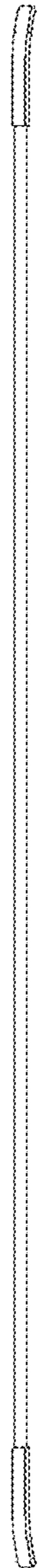

FIG. 14



FIG. 15

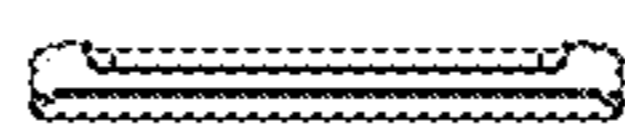

FIG. 16

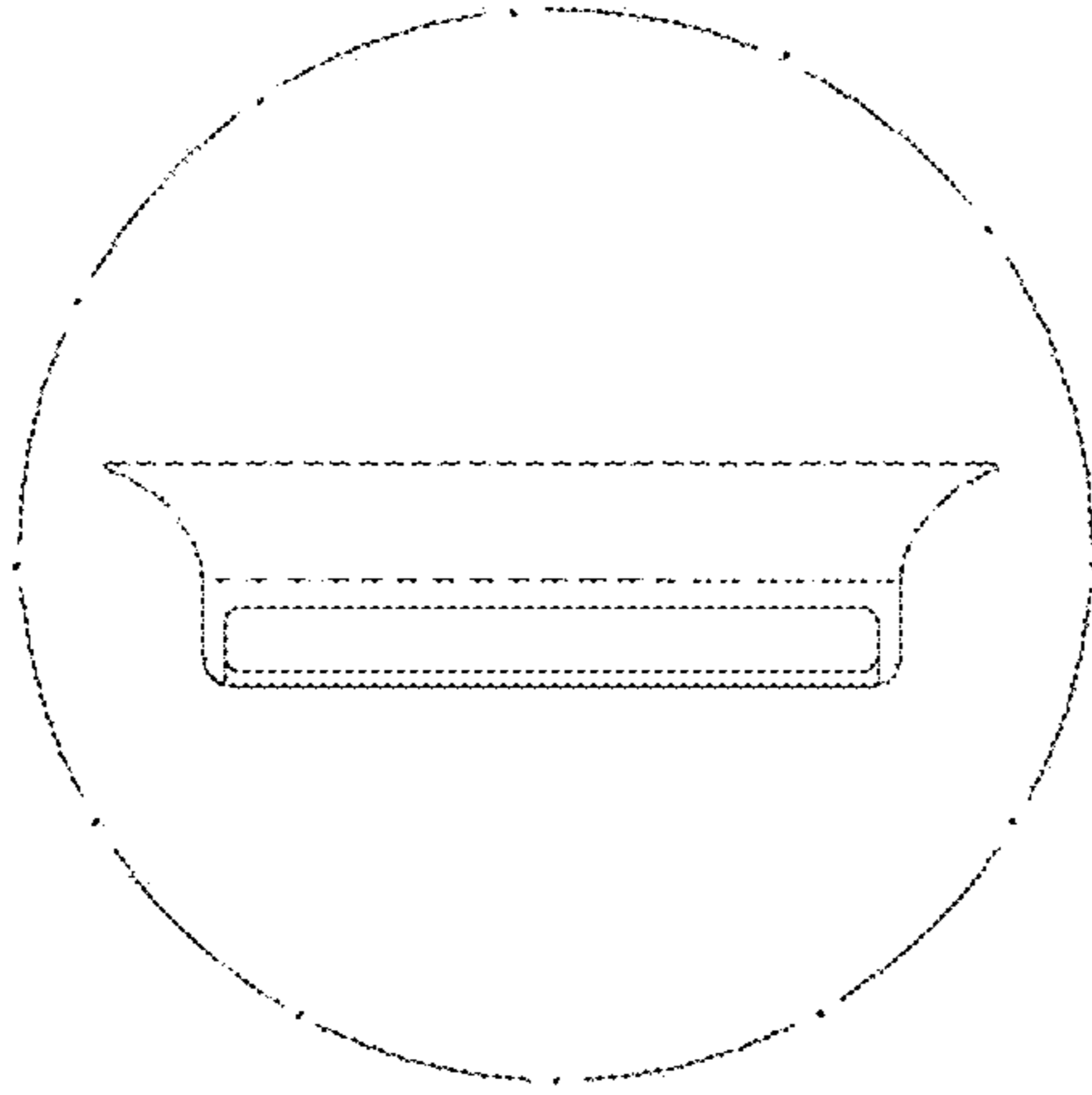

FIG.17

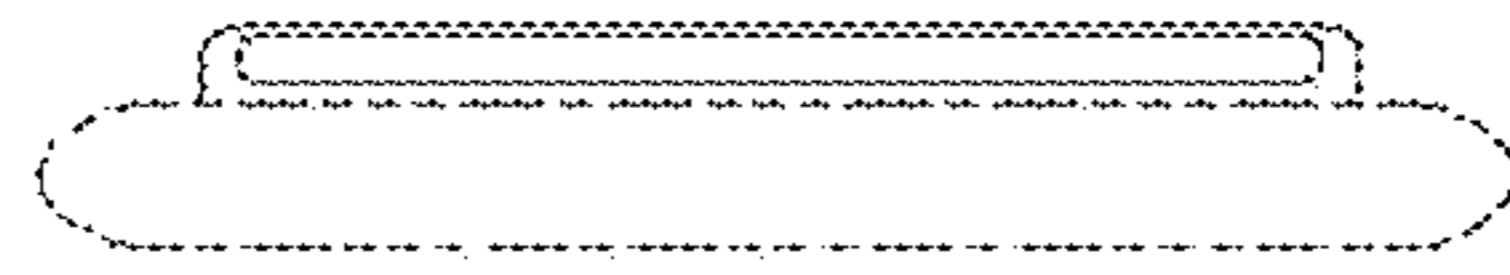

FIG.20

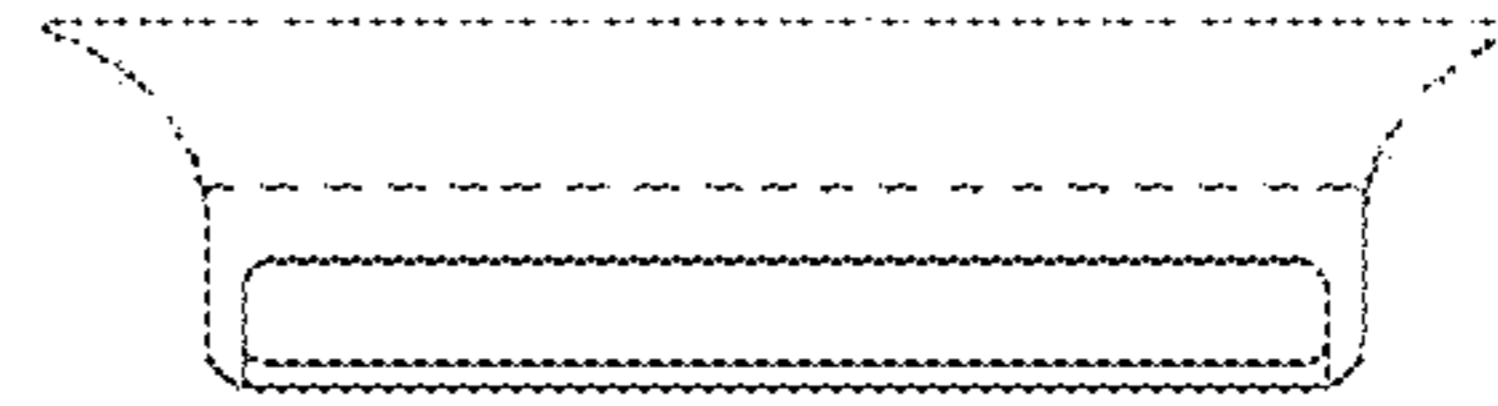

FIG.21

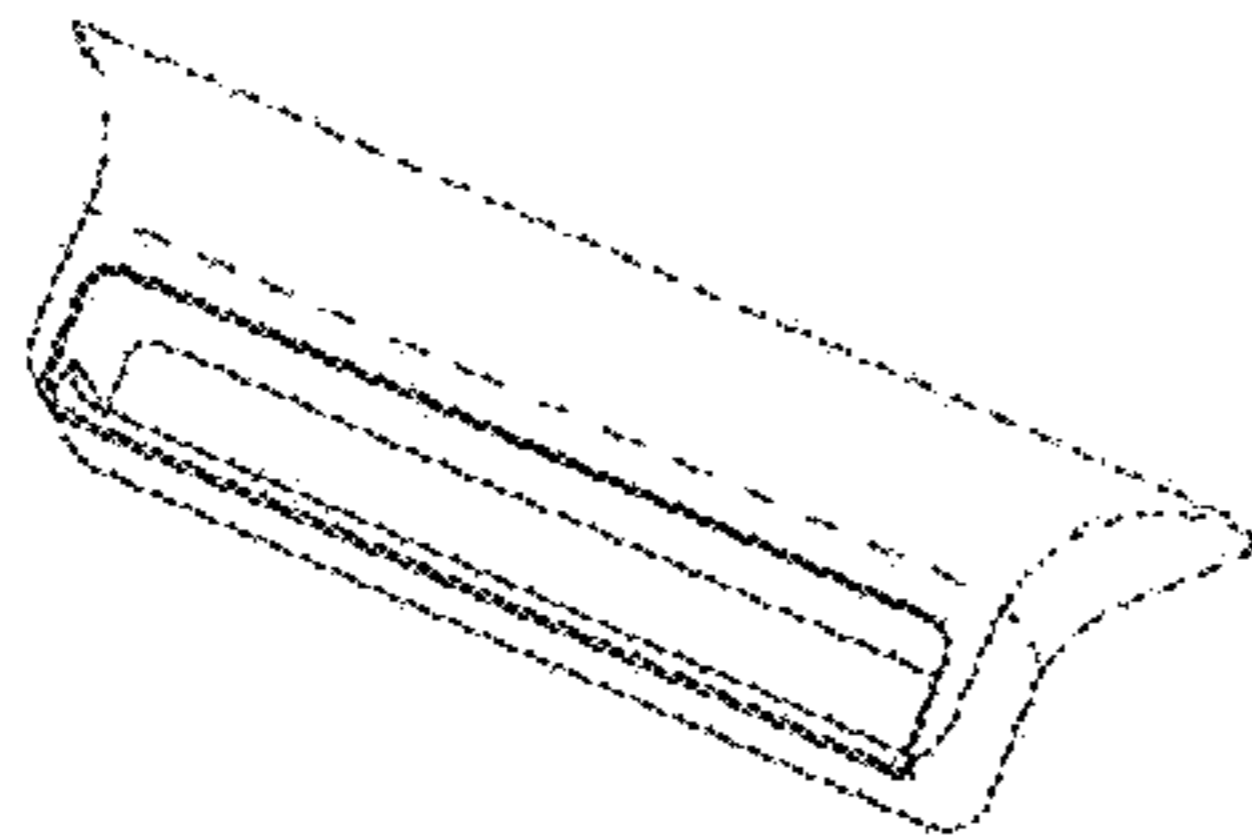

FIG.18

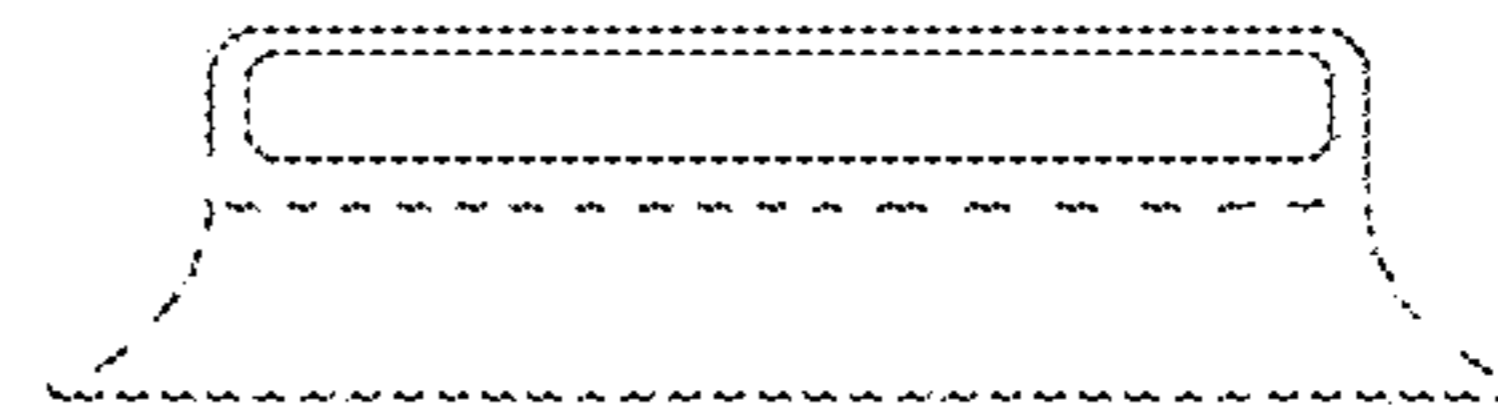

FIG.22

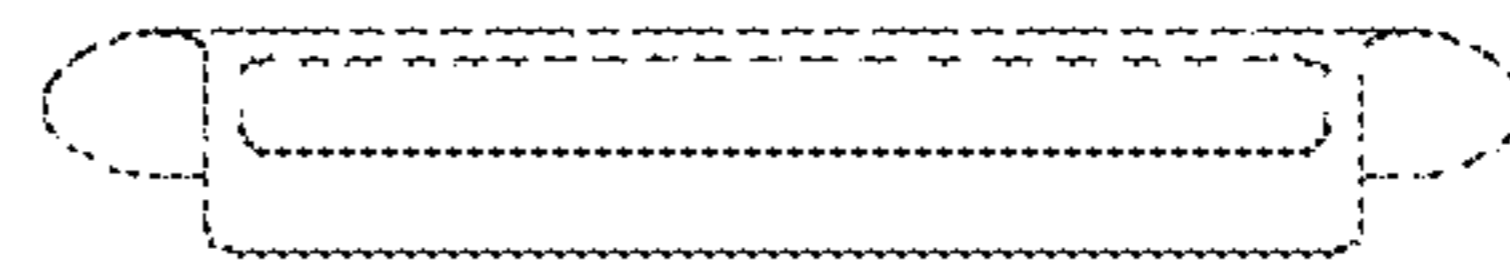

FIG.23

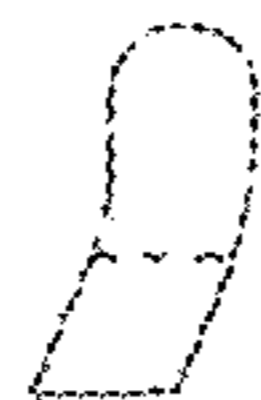

FIG.19

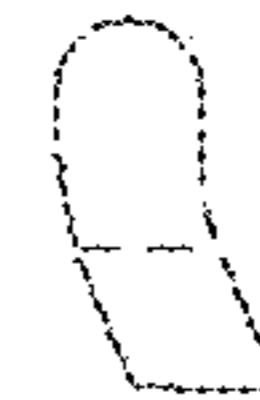

FIG.24