



US00D972334S

(12) **United States Design Patent**  
**Maguire et al.**

(10) **Patent No.:** **US D972,334 S**

(45) **Date of Patent:** **\*\* Dec. 13, 2022**

- (54) **TOILET PAPER ROLL COVER**
- (71) Applicants: **Kim Maguire**, Katonah, NY (US);  
**Eileen Walker**, Monroe, NY (US)
- (72) Inventors: **Kim Maguire**, Katonah, NY (US);  
**Eileen Walker**, Monroe, NY (US)
- (\*\*) Term: **15 Years**
- (21) Appl. No.: **29/707,615**
- (22) Filed: **Sep. 30, 2019**
- (51) **LOC (13) Cl.** ..... **23-08**
- (52) **U.S. Cl.**  
USPC ..... **D6/523**
- (58) **Field of Classification Search**  
USPC ..... D6/523, 518–522; 206/389, 398;  
211/85.5; 242/550, 598.5, 598.6, 609.5;  
312/34.8; D8/300, 303, 315–321  
CPC ..... A47K 10/38; A47K 2010/3266; A47K  
2010/3253; A47K 10/421; A47K 13/22;  
B65D 83/0805  
See application file for complete search history.

- D487,858 S \* 3/2004 Richardson ..... D6/523
- D514,360 S \* 2/2006 Richardson ..... D6/523
- D658,414 S \* 5/2012 Renzelman ..... D6/523
- D690,126 S \* 9/2013 Ogawa ..... D6/518
- D702,054 S \* 4/2014 Garrett ..... D6/523
- D779,228 S \* 2/2017 Hamilton, Jr. .... D6/523

\* cited by examiner

*Primary Examiner* — Mary Shannon Malley  
(74) *Attorney, Agent, or Firm* — Scott H. Kaliko, Esq.;  
Kaliko & Associates, LLC

(57) **CLAIM**

The ornamental design for a toilet paper roll cover, as shown and described.

**DESCRIPTION**

FIG. 1 is a FRONT PERSPECTIVE view of a design for the toilet paper roll COVER;  
FIG. 2 is a FRONT view thereof;  
FIG. 3 is a BACK view thereof;  
FIG. 4 is a SIDE view of thereof;  
FIG. 5 is another SIDE view thereof;  
FIG. 6 is a TOP view thereof;  
FIG. 7 is a BOTTOM view thereof; and,  
FIG. 8 is a FRONT PERSPECTIVE view thereof showing how the front Panel may be changed.  
The broken lines illustrate portions of the toilet paper roll cover that form no part of the claimed design.

(56) **References Cited**

U.S. PATENT DOCUMENTS

- D294,789 S \* 3/1988 Nunnally ..... D6/523
- D462,551 S \* 9/2002 Mayer ..... D6/523

**1 Claim, 5 Drawing Sheets**

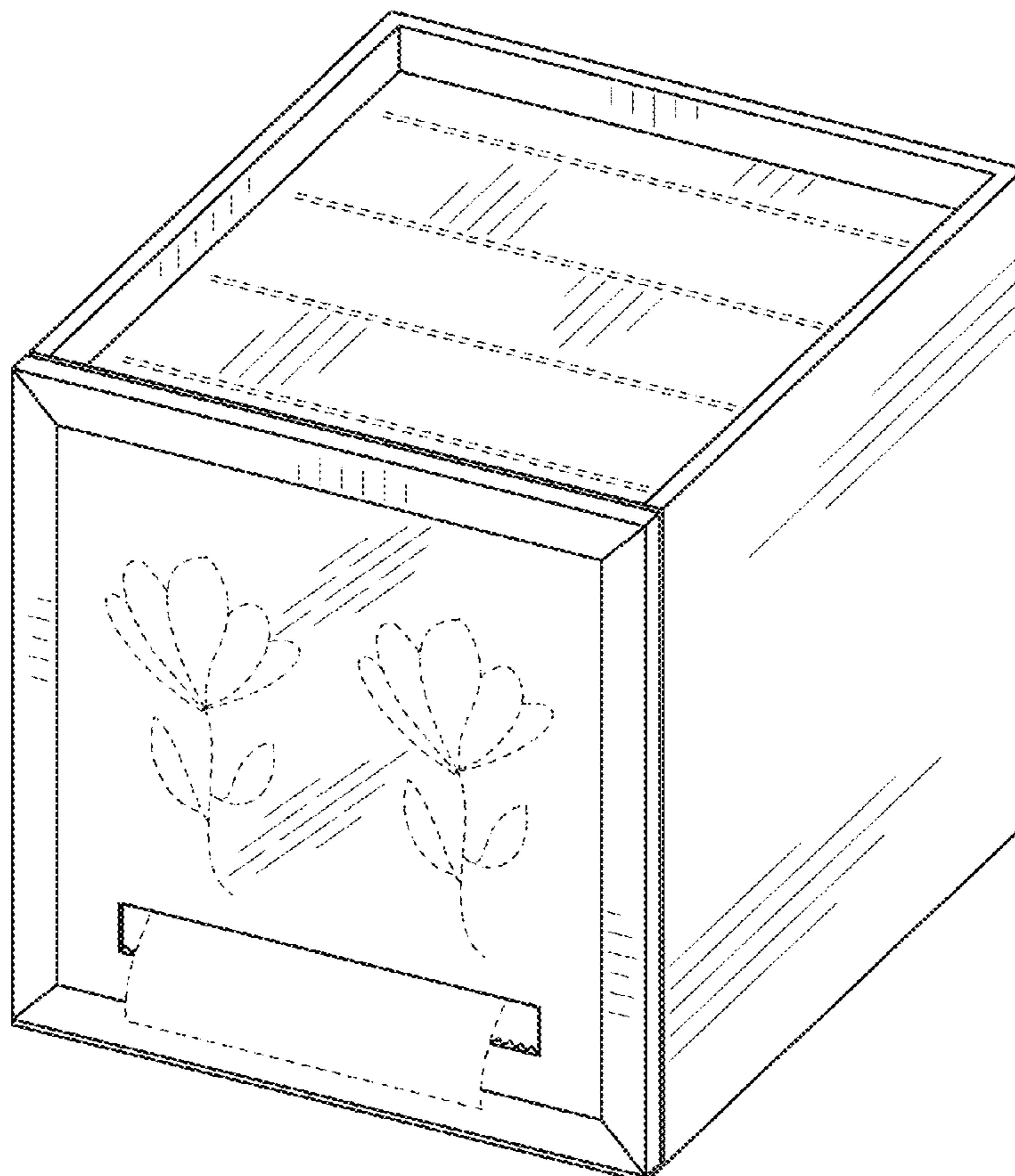

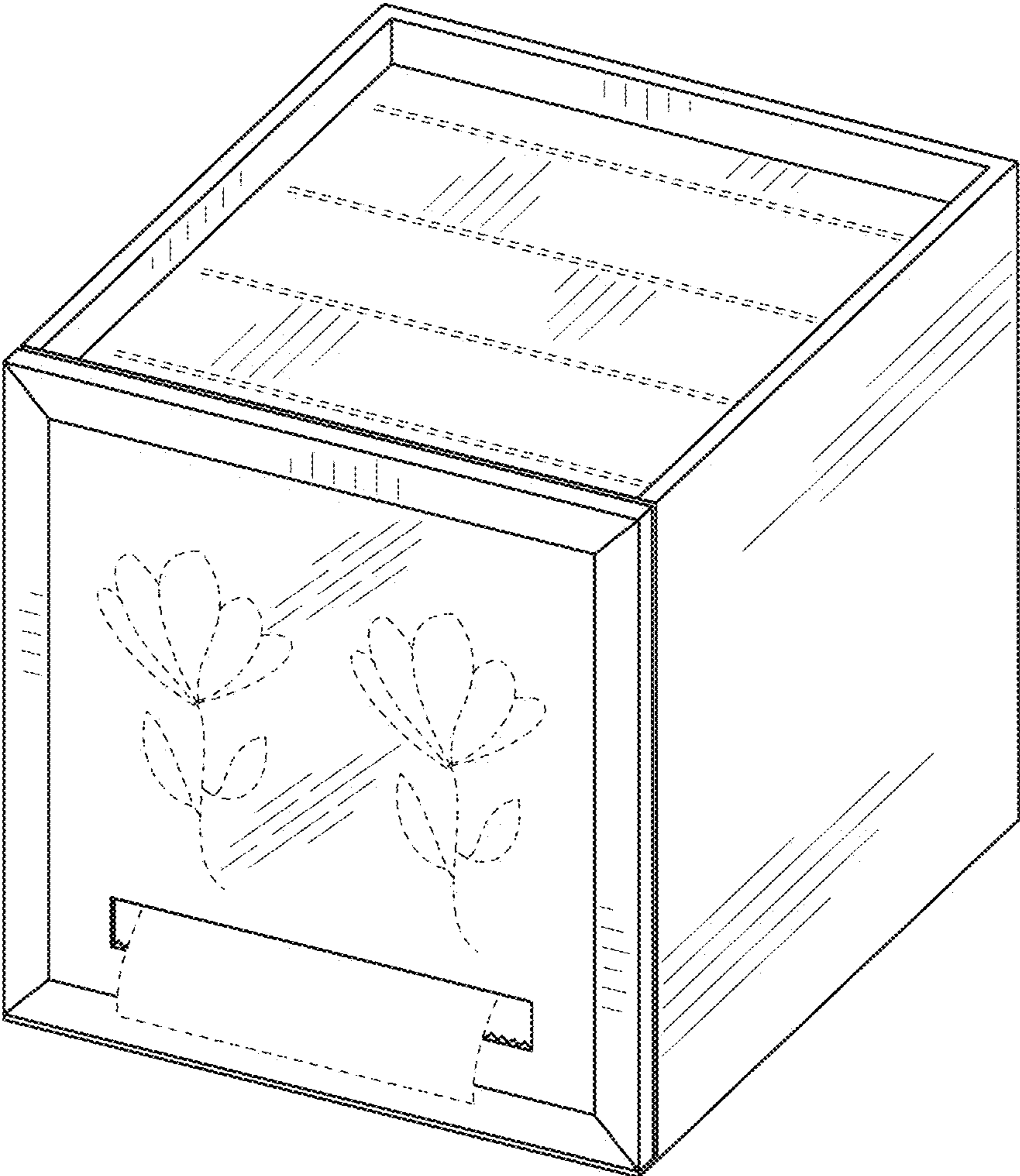

FIG. 1

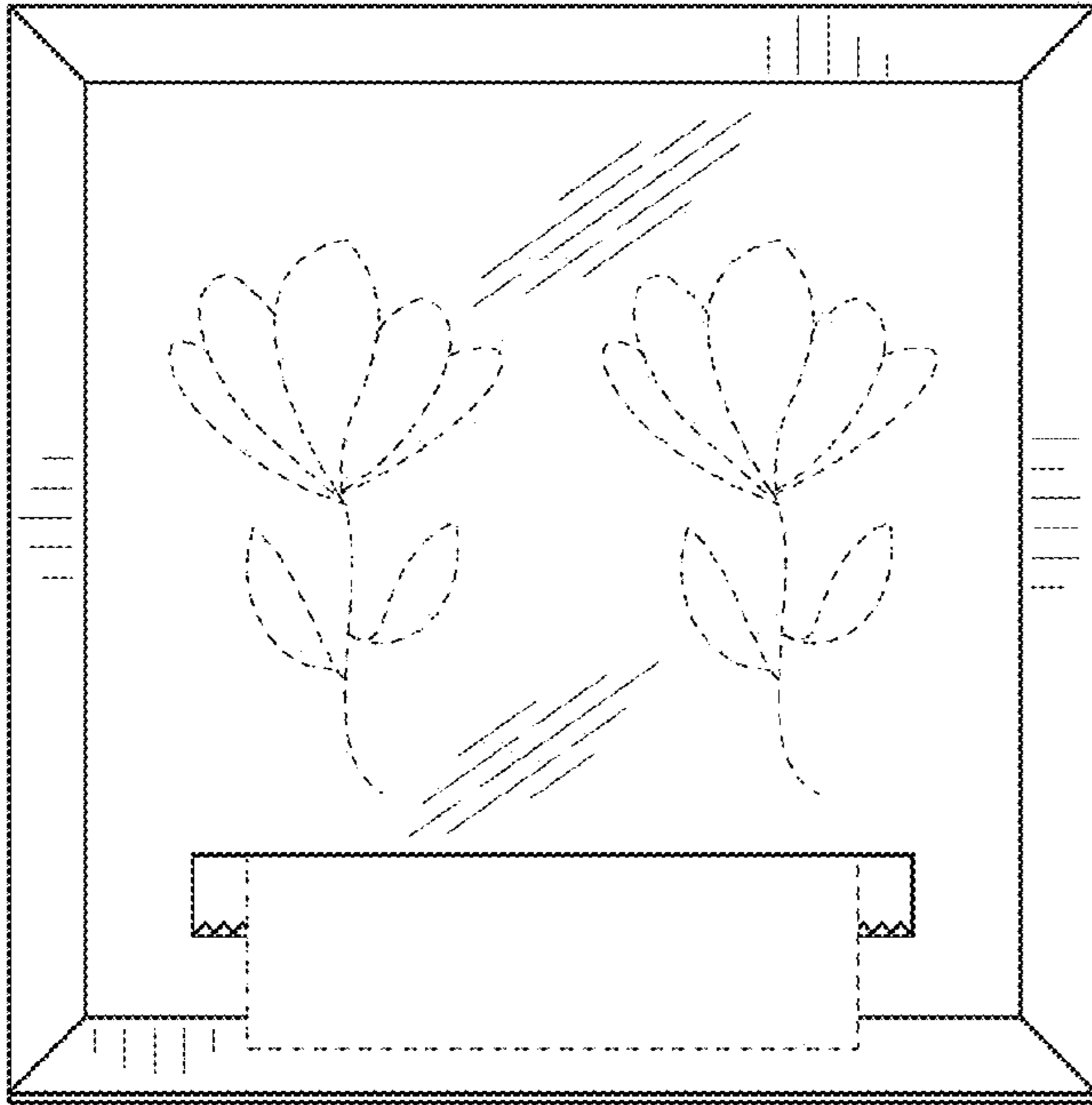

FIG. 2

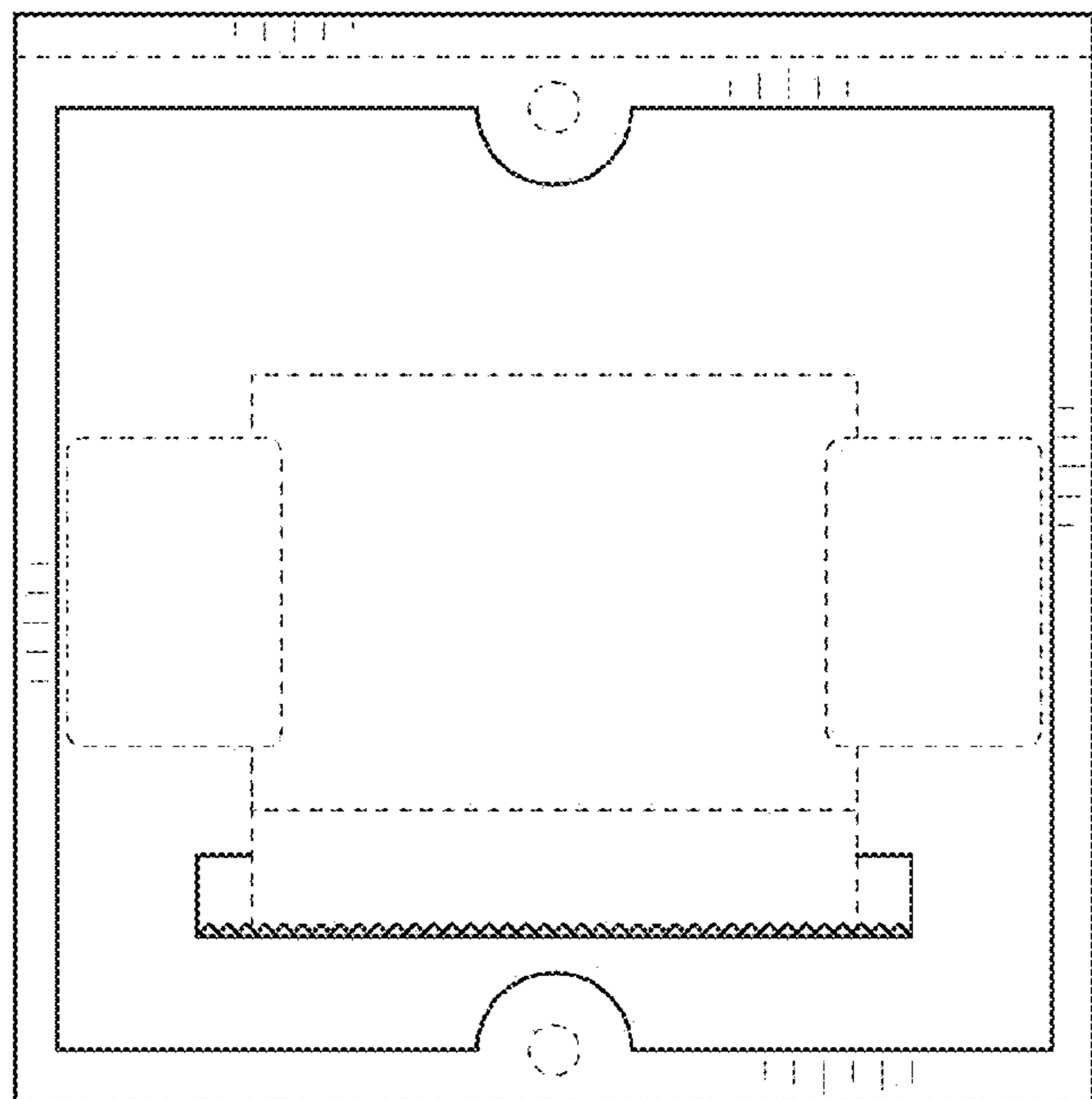

FIG. 3

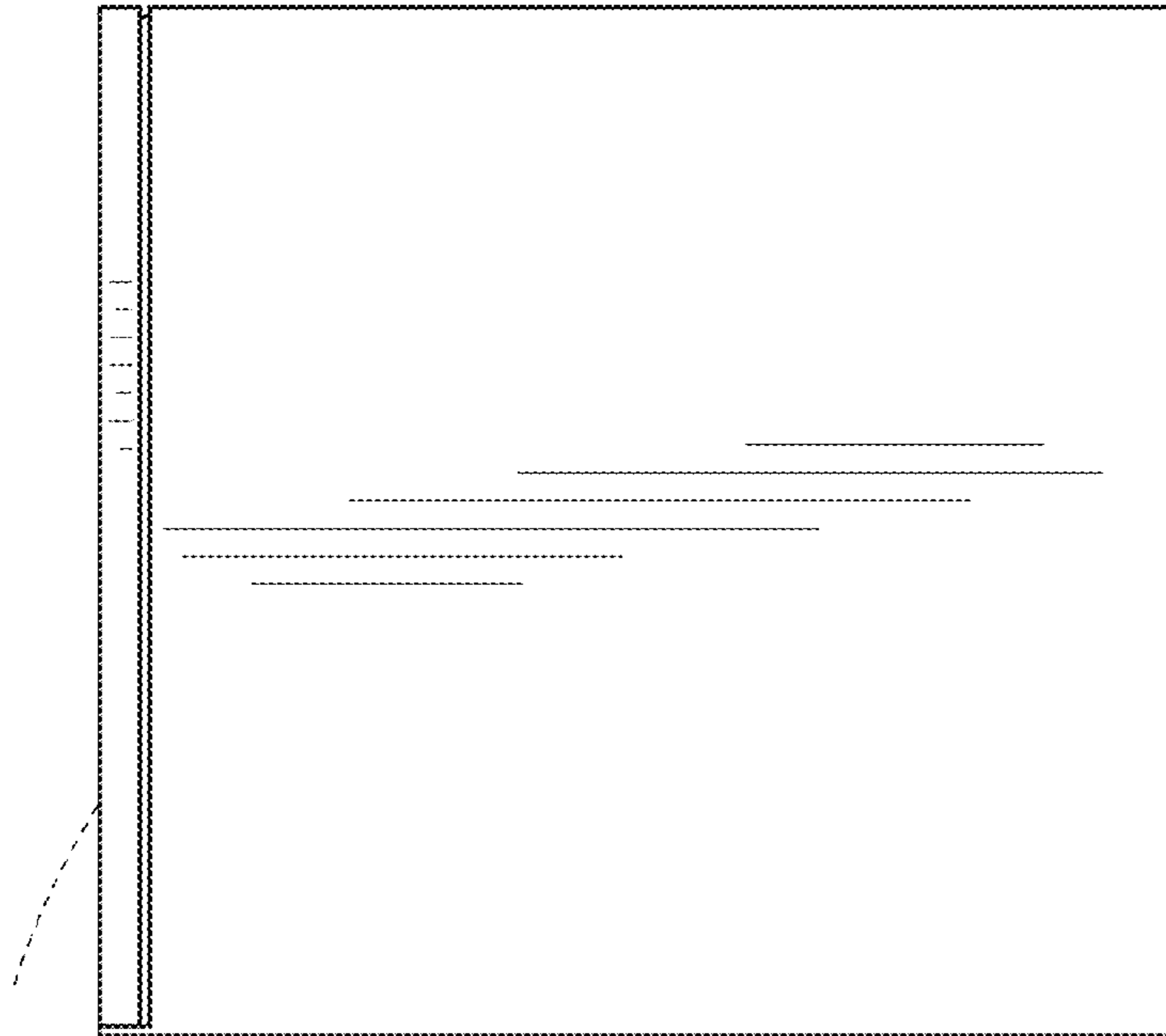

FIG. 4

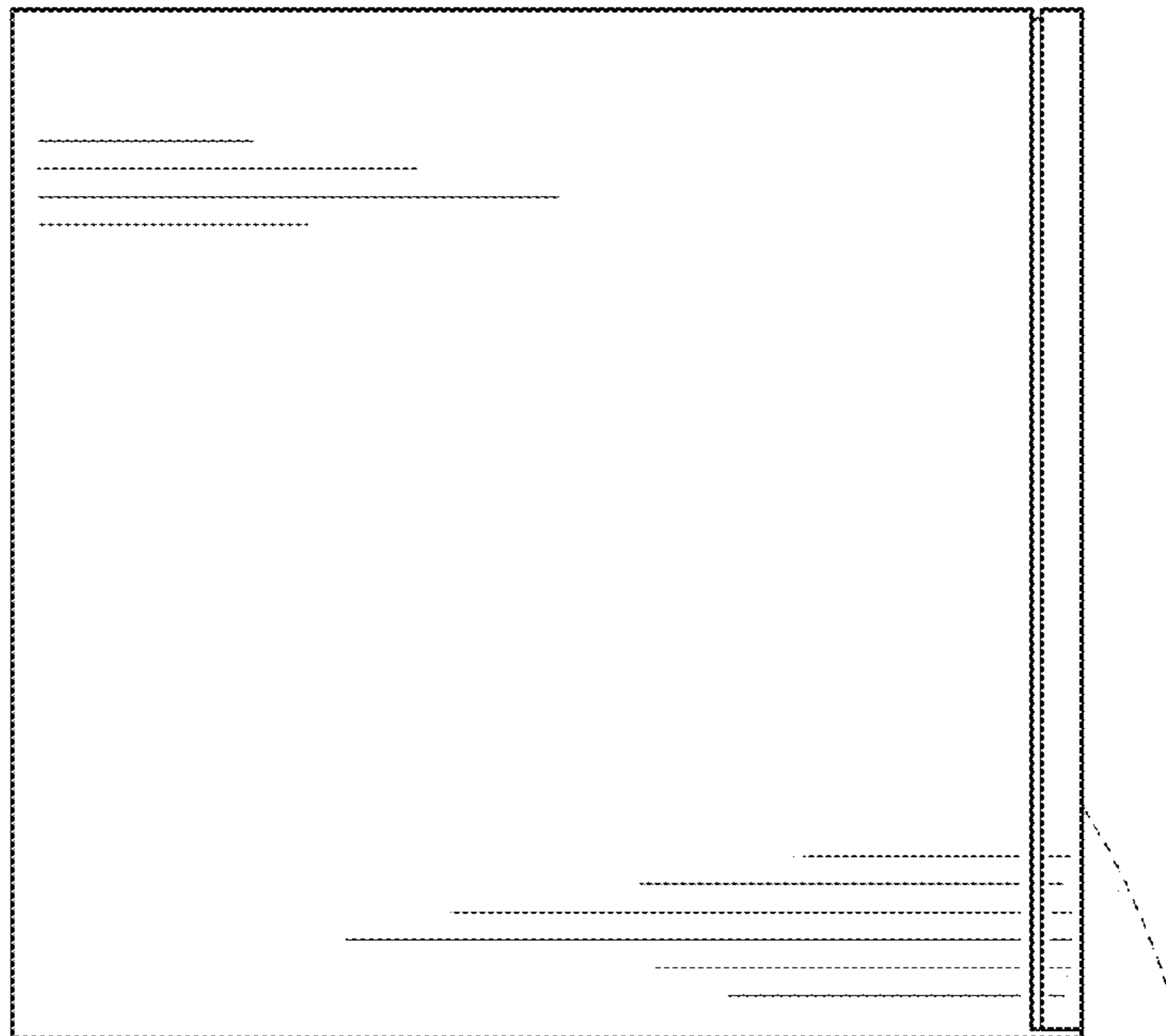
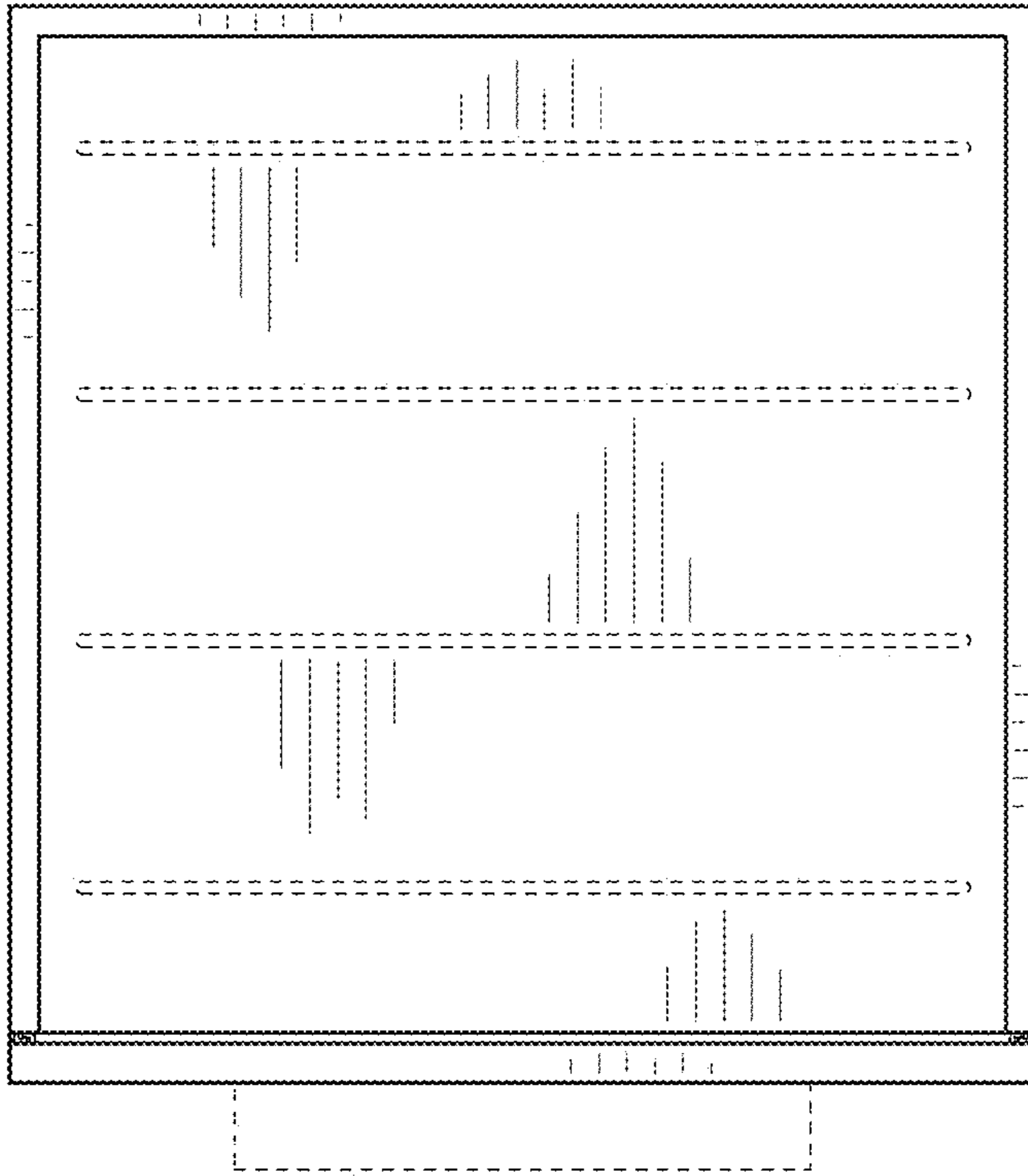
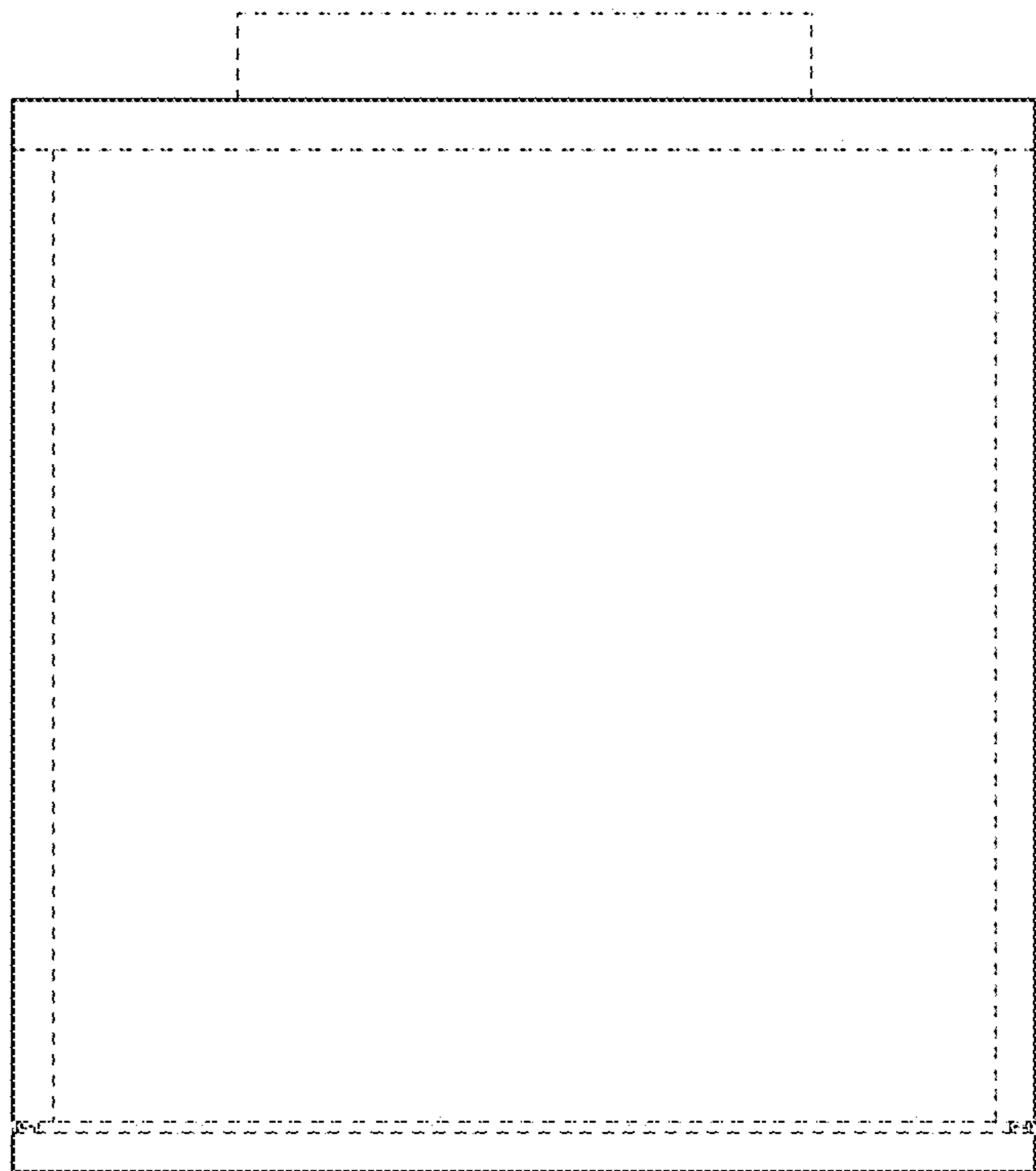

FIG. 5



**FIG. 6**



**FIG. 7**

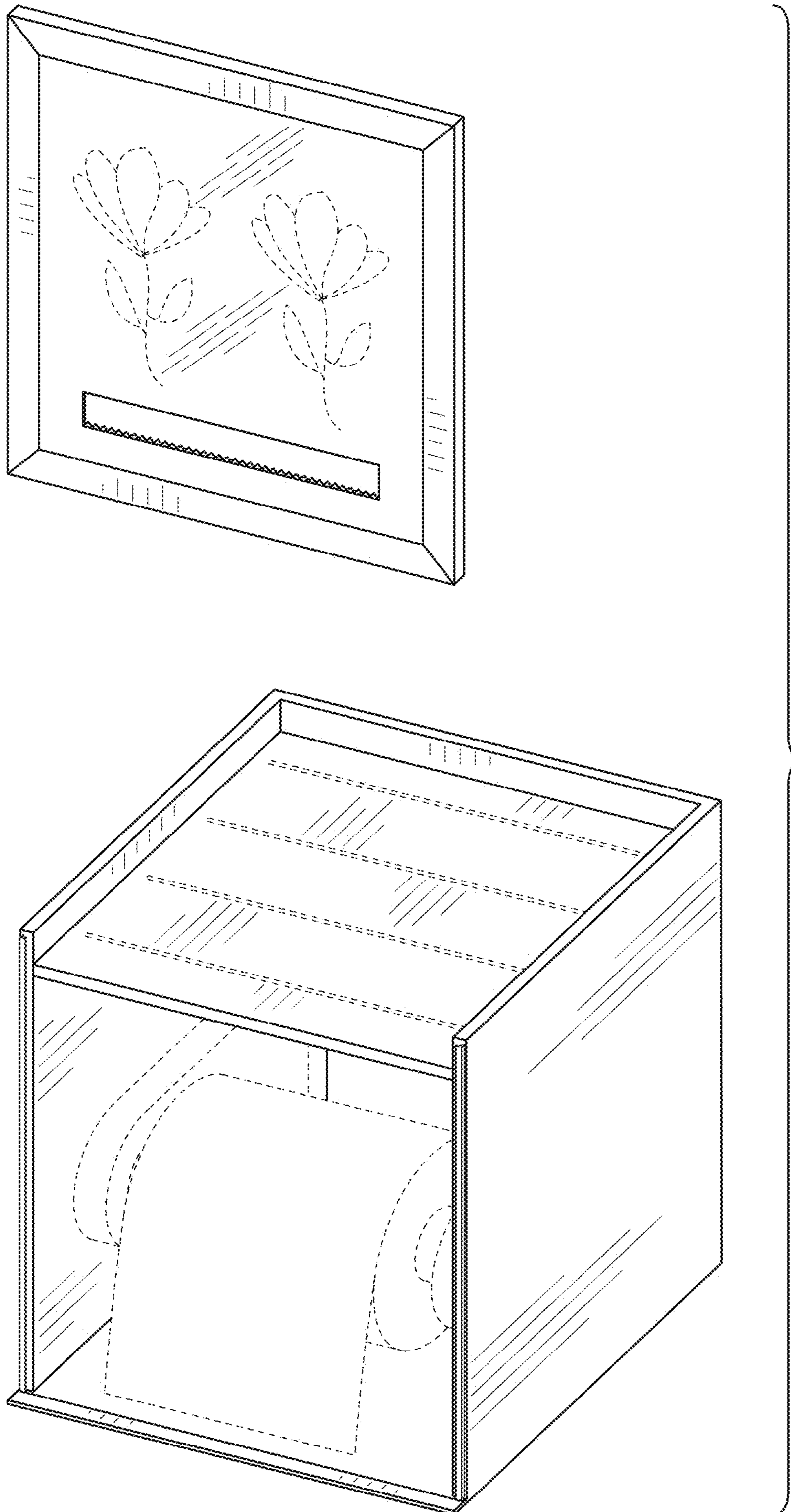

FIG. 8