



US00D972307S

(12) **United States Design Patent** (10) **Patent No.:** **US D972,307 S**
Liang (45) **Date of Patent:** **** Dec. 13, 2022**

(54) **POWER SCRUBBER**
(71) Applicant: **ZHONGSHAN SUNPOWER SMART HOME ELECTRICAL COMPANY LIMITED**, Zhongshan (CN)

(72) Inventor: **Jinran Liang**, Zhongshan (CN)

(73) Assignee: **ZHONGSHAN SUNPOWER SMART HOME ELECTRICAL COMPANY LIMITED**, Zhongshan (CN)

(**) Term: **15 Years**

(21) Appl. No.: **29/775,506**

(22) Filed: **Mar. 24, 2021**

(51) **LOC (13) Cl.** **04-02**

(52) **U.S. Cl.**
USPC **D4/102**

(58) **Field of Classification Search**
USPC D4/100, 102, 116, 117, 118, 121, 122, D4/127, 128, 130, 131, 132, 133, 134, D4/138; D24/214, 215; D30/158, 159
CPC A46B 2200/1006; A46B 2200/102; A46B 2200/10

See application file for complete search history.

(56) **References Cited**

U.S. PATENT DOCUMENTS

D646,487 S *	10/2011	Leppla	D4/127
D713,150 S *	9/2014	Maurin	D4/102
D720,933 S *	1/2015	Albers	D4/120
D739,145 S *	9/2015	von Berg	D4/127
D750,893 S *	3/2016	Owen	D4/100
D760,498 S *	7/2016	Kim	D4/127
D784,703 S *	4/2017	Grabes	D4/102
D825,188 S *	8/2018	Luo	D4/101
D871,770 S *	1/2020	Diener	D4/116
D884,356 S *	5/2020	Jung	D28/9
D931,616 S *	9/2021	Peng	D4/102

D932,778 S *	10/2021	Jing	D4/102
D964,750 S *	9/2022	Mei	D4/127
2008/0106156 A1 *	5/2008	Reishus	A46B 13/02 310/15

FOREIGN PATENT DOCUMENTS

EM 008913230-0001 * 4/2022

OTHER PUBLICATIONS

Labigo, announced Jul. 2022 [online], [site visited Oct. 13, 2022]. Avail from int, URL: https://www.amazon.com/LABIGO-Electric-Scrubber-Replaceable-Adjustable/dp/B0B713YZ2B/ref=sr_1_54 (Year: 2022).*

(Continued)

Primary Examiner — Cynthia Ramirez

Assistant Examiner — Tamara L Hahn

(57) **CLAIM**

The ornamental design for a power scrubber, as shown and described.

DESCRIPTION

FIG. 1 is a perspective view of a power scrubber showing my new design;
FIG. 2 is another perspective view thereof;
FIG. 3 is a front elevational view thereof;
FIG. 4 is a rear elevational view thereof;
FIG. 5 is a left side elevational view thereof;
FIG. 6 is a right side elevational view thereof;
FIG. 7 is a top plan view thereof;
FIG. 8 is a bottom plan view thereof; and,
FIG. 9 is an enlarged view of portion 9 shown in FIG. 2.
The broken lines in the drawings depict portions of the power scrubber that form no part of the claimed design. The dot-dash broken lines depict enlarged views that form no part of the claimed design.

1 Claim, 9 Drawing Sheets

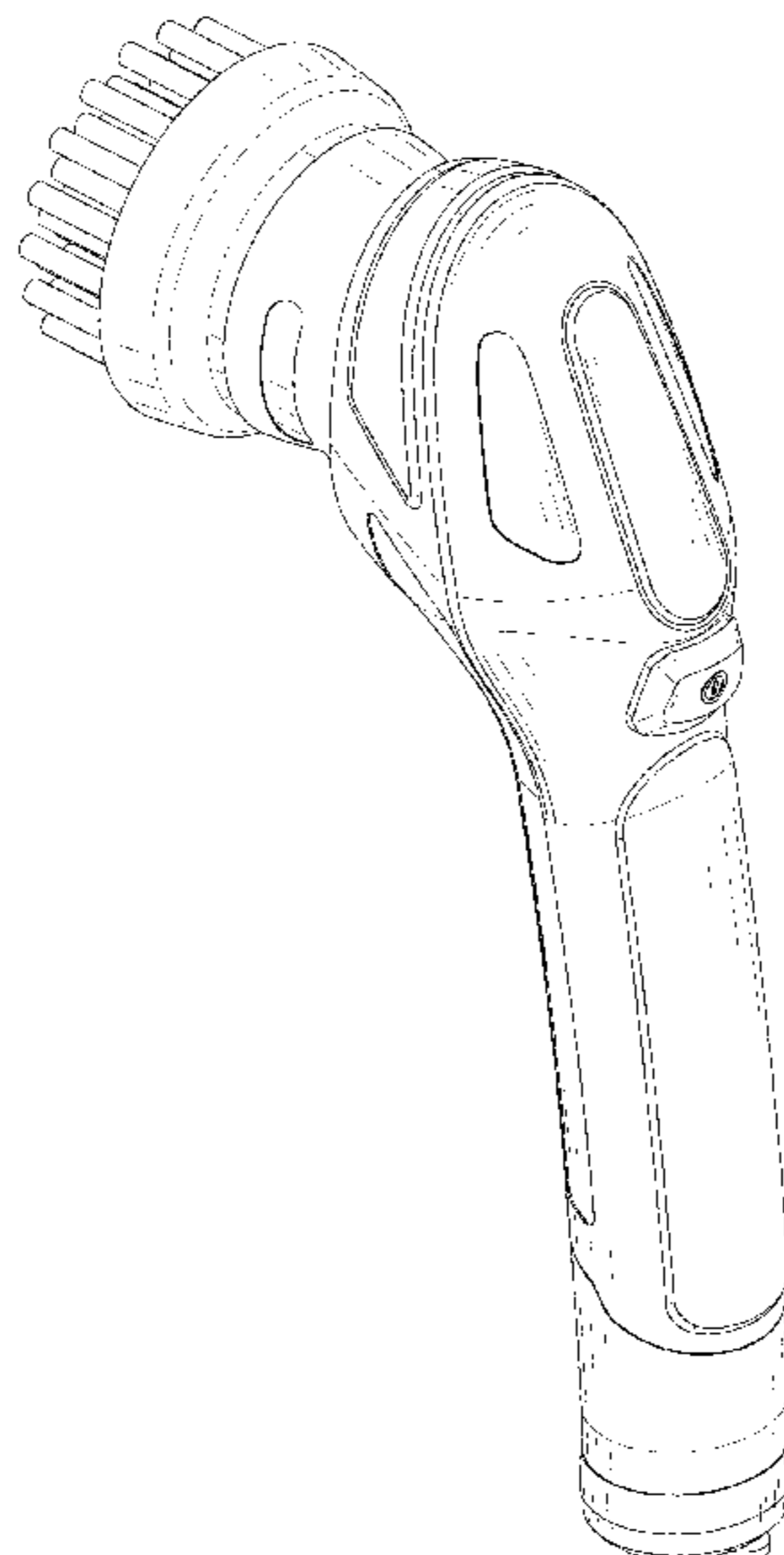

(56)

References Cited

OTHER PUBLICATIONS

Exfeeko, announced Dec. 2021 [online], [site visited Oct. 13, 2022]. Avail from int, URL: https://www.amazon.com/Electric-Scrubber-Replaceable-Detachable-Household/dp/B09PDHLLM8/ref=sr_1_16 (Year: 2021).*

July Home, announced May 2022 [online], [site visited Oct. 13, 2022]. Avail from int, URL: https://www.amazon.com/JULY-HOME-Electric-Spin-Scrubber/dp/B0B27T9VVZ/ref=sr_1_30 (Year: 2022).*

Alovelx, announced May 2022 [online], [site visited Oct. 13, 2022]. Avail from int, URL: https://www.amazon.com/dp/B0B1Q6WNFH/ref=sspa_dk_detail_3 (Year: 2022).*

* cited by examiner

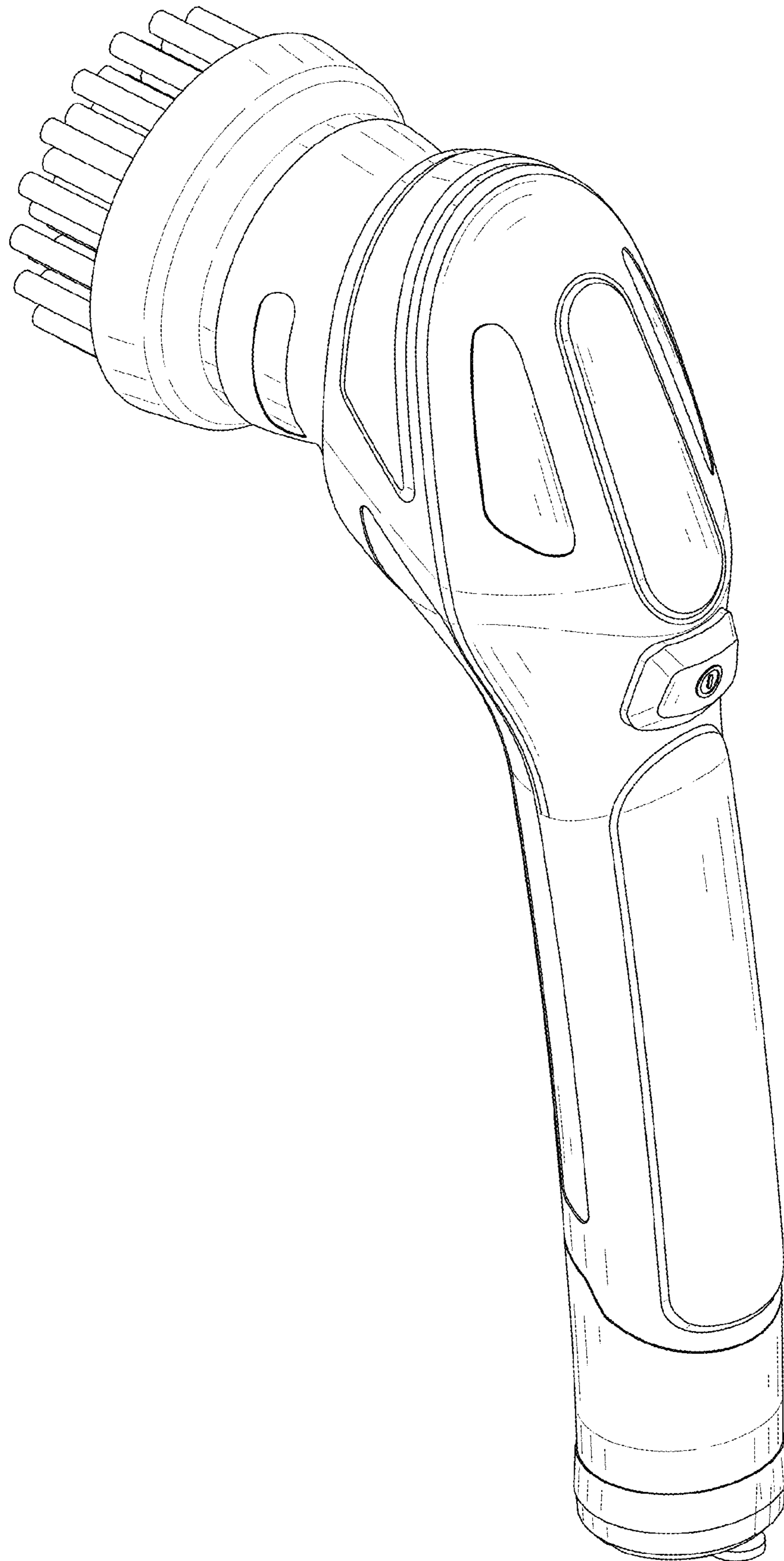

FIG. 1

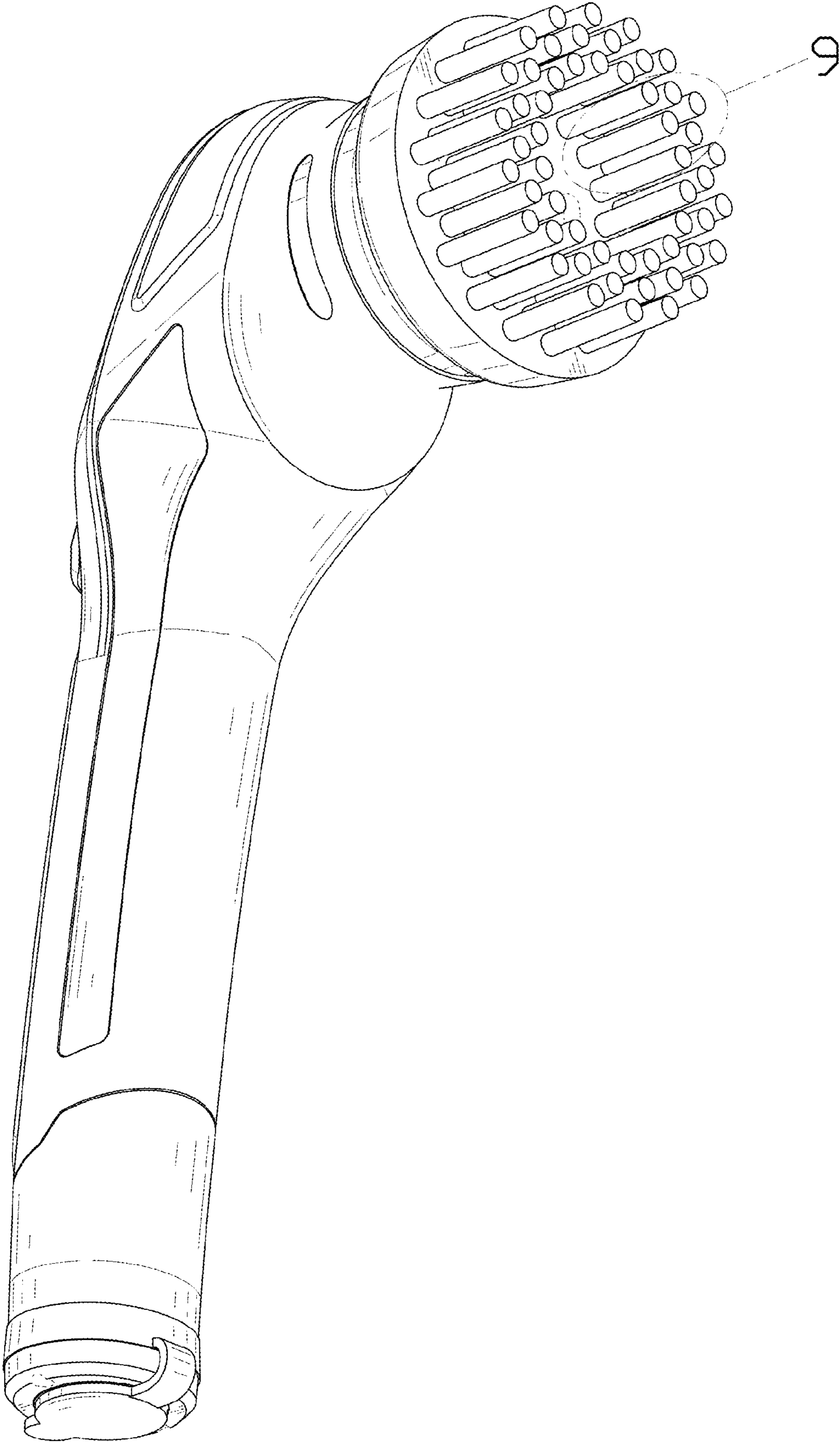

FIG. 2

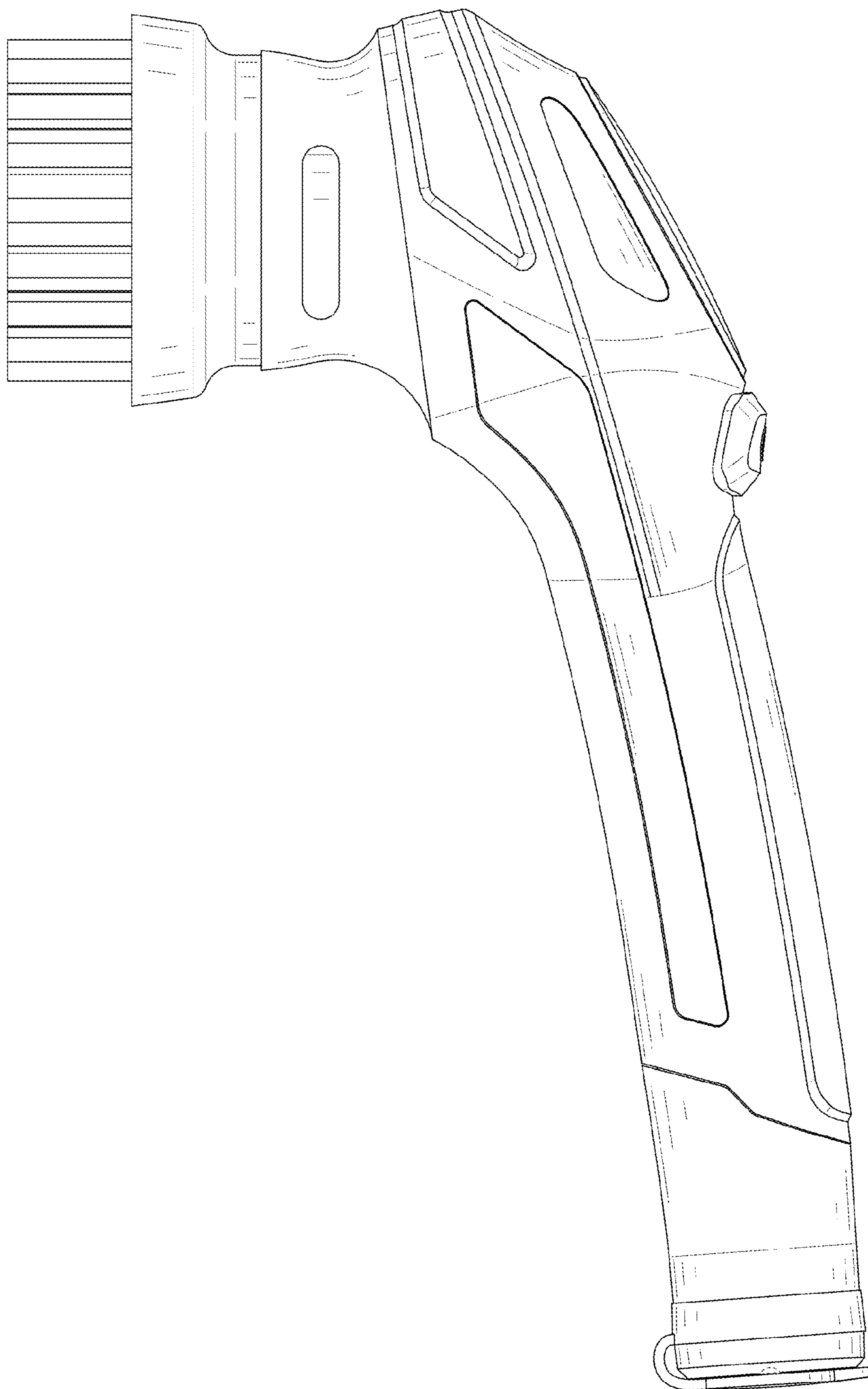

FIG. 3

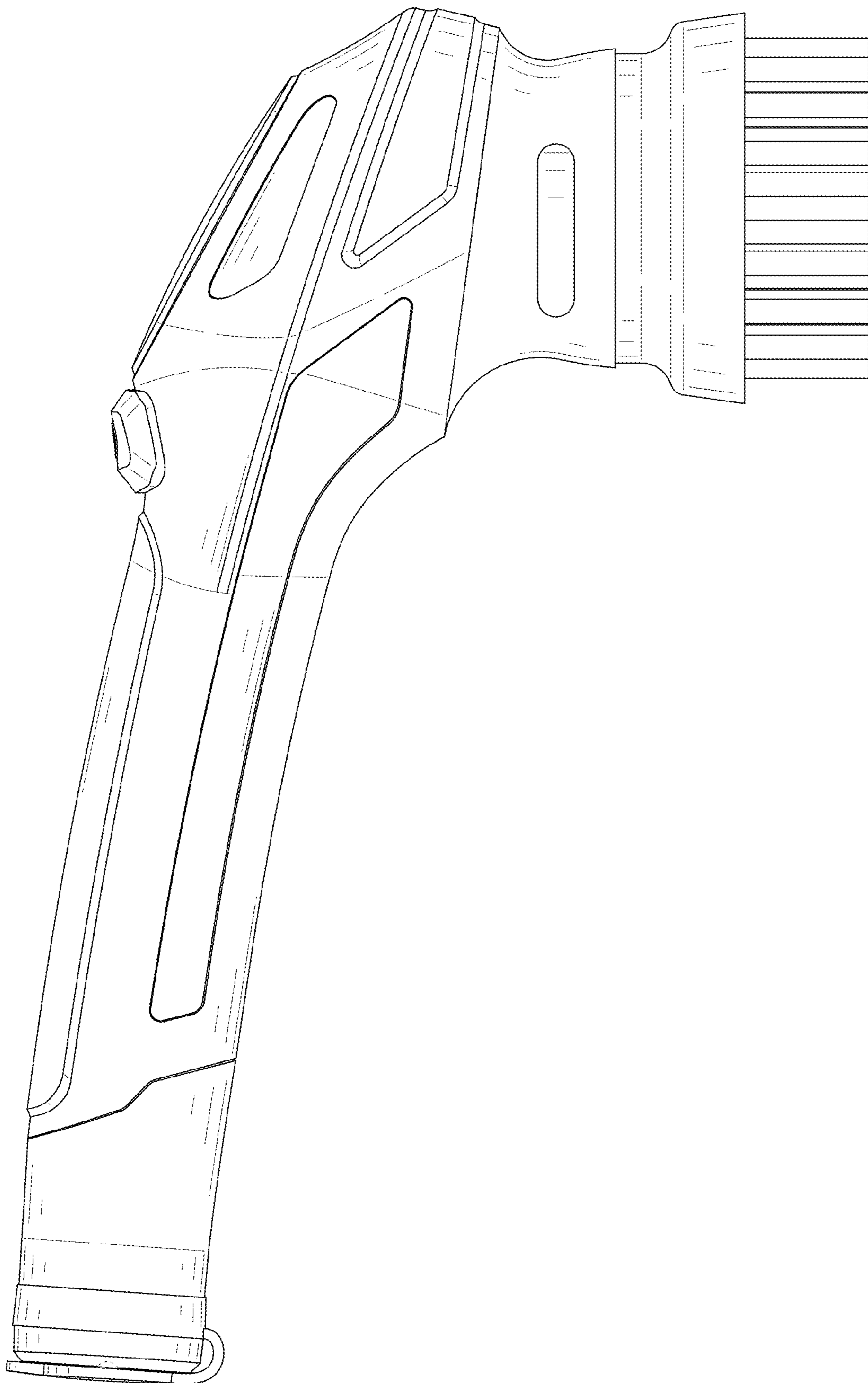

FIG. 4

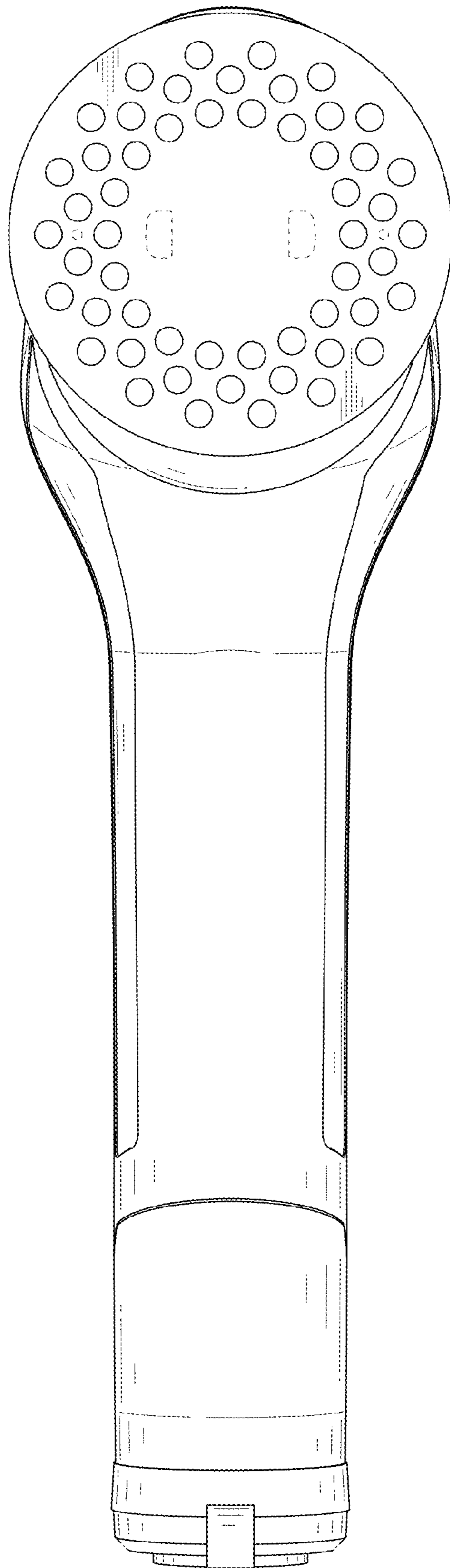

FIG. 5

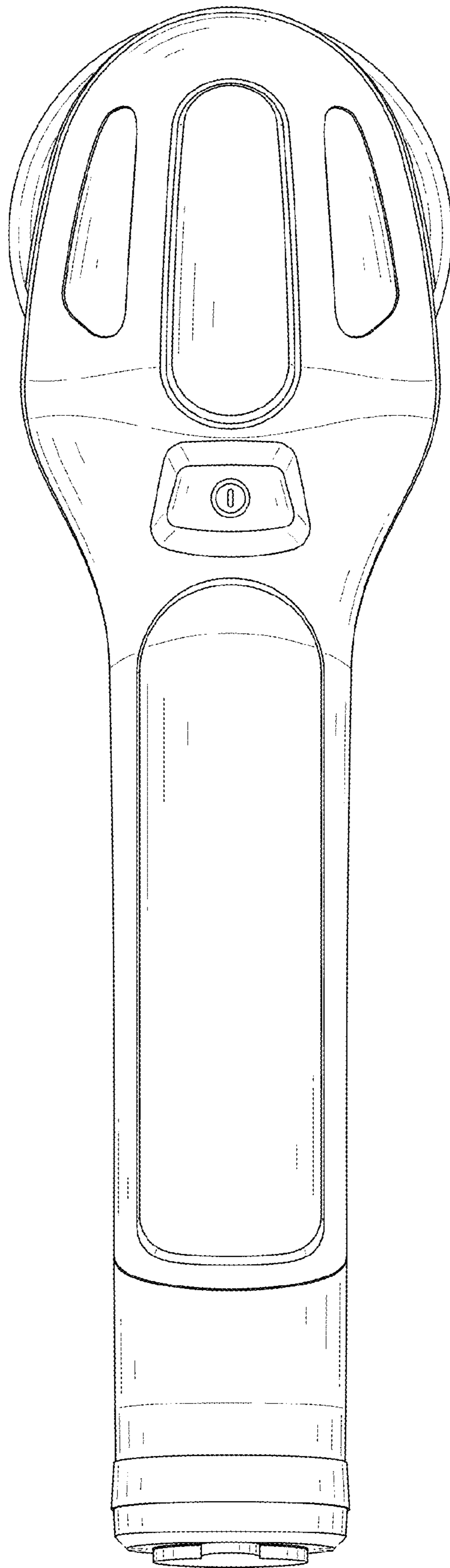

FIG. 6

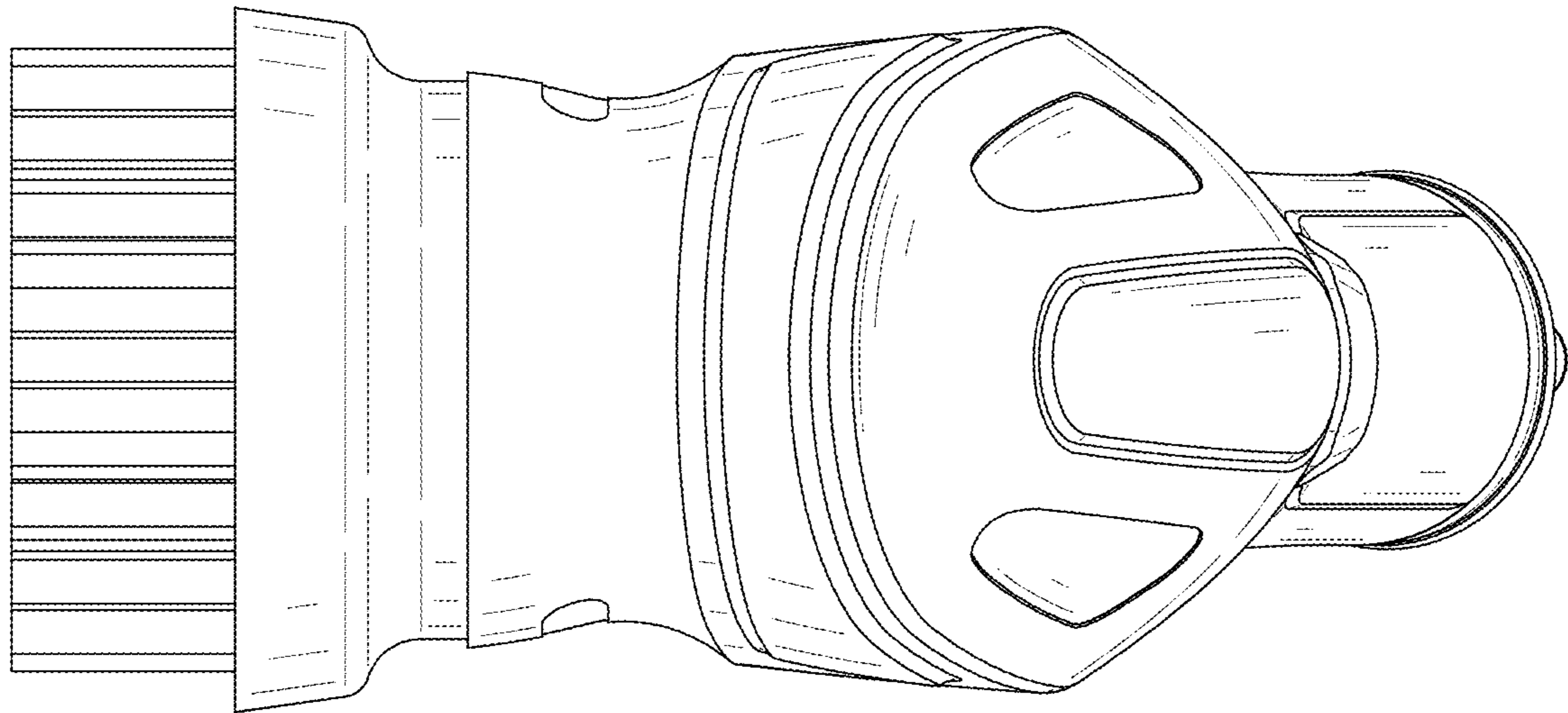

FIG. 7

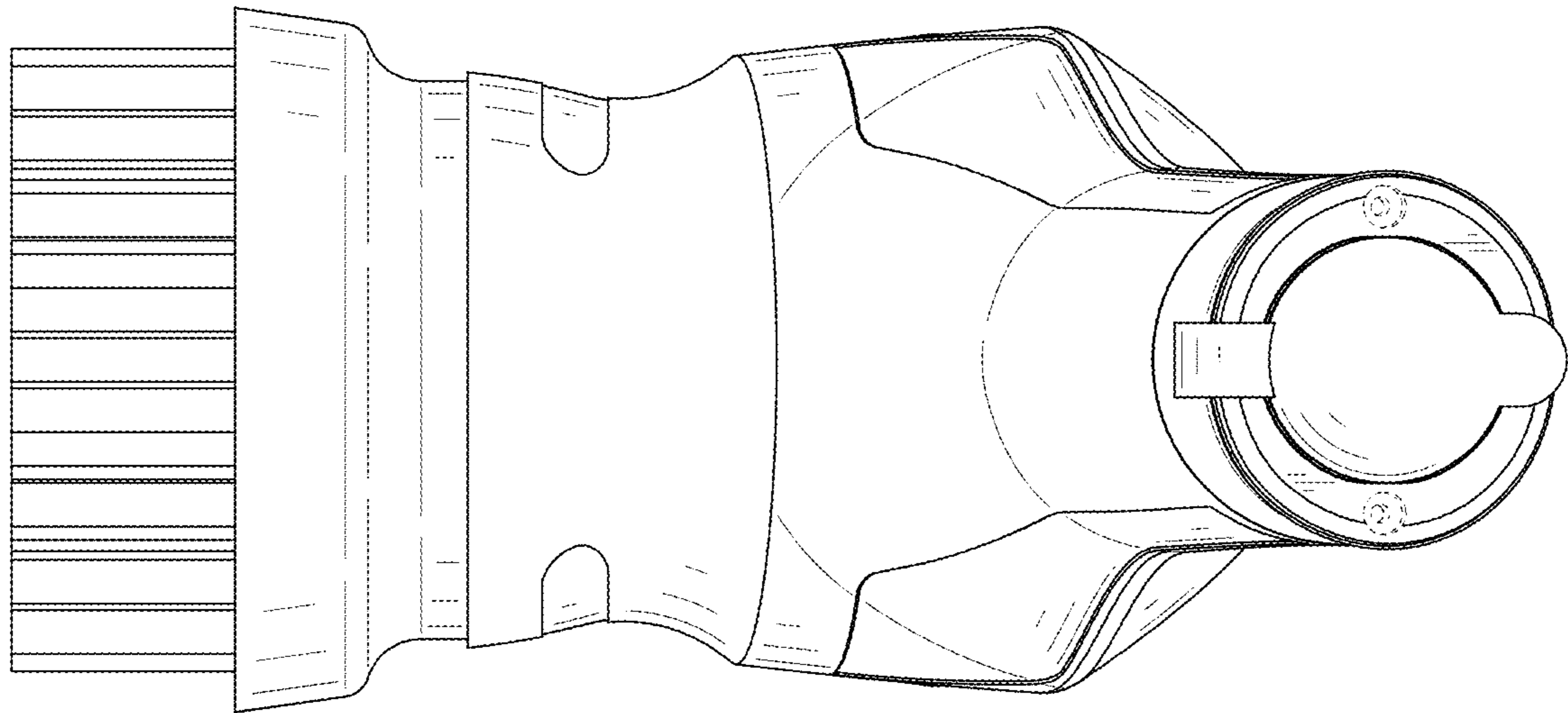

FIG. 8

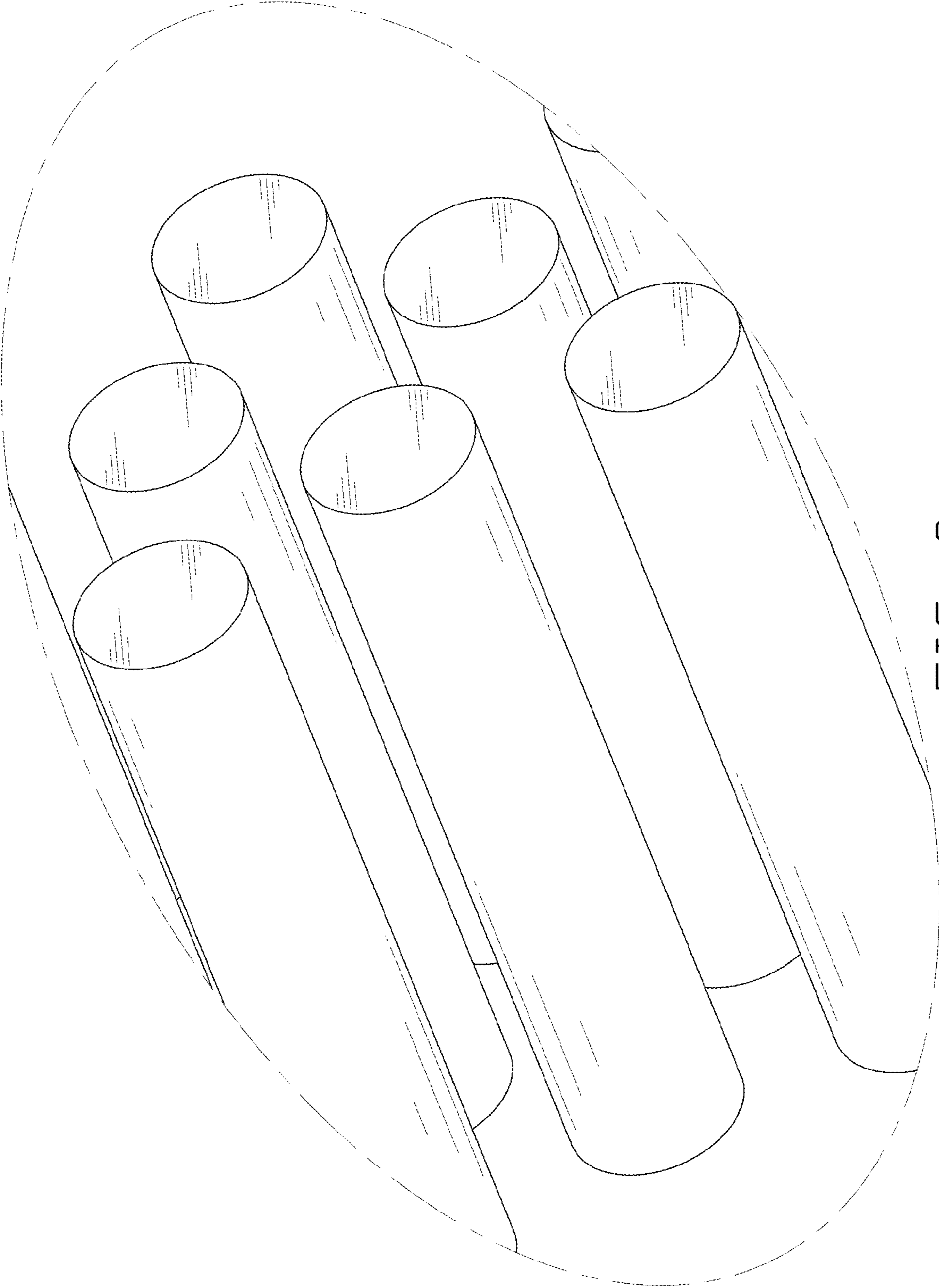

FIG. 9