



US00D972213S

(12) **United States Design Patent**
Wang

(10) **Patent No.:** **US D972,213 S**

(45) **Date of Patent:** **** Dec. 6, 2022**

(54) **LADY SHAVER**

(71) Applicant: **Xiaojun Wang**, Zhejiang (CN)

(72) Inventor: **Xiaojun Wang**, Zhejiang (CN)

(73) Assignee: **Zhejiang Brori Electric Tech Co., Ltd.**, Zhejiang (CN)

(**) Term: **15 Years**

(21) Appl. No.: **29/736,903**

(22) Filed: **Jun. 3, 2020**

(51) **LOC (13) Cl.** **28-03**

(52) **U.S. Cl.**
USPC **D28/49**

(58) **Field of Classification Search**
USPC D28/44-54; D13/108
CPC B26B 19/00; B26B 19/12; B26B 19/14;
B26B 19/30; B26B 19/38; B26B 19/3853;
B26B 19/3873; B26B 21/00; B26B 21/08;
B26B 21/20; B26B 21/52

See application file for complete search history.

(56) **References Cited**

U.S. PATENT DOCUMENTS

D429,377 S *	8/2000	Allende	D28/49
D558,399 S *	12/2007	Seki	D28/49
10,104,950 B1 *	10/2018	Provost	A45D 27/29
10,421,203 B2 *	9/2019	Perez Lopez	B26B 19/3886
D891,696 S *	7/2020	Van Maanen	D28/44
11,260,550 B2 *	3/2022	Neyer	B26B 19/38
2002/0153863 A1 *	10/2002	Arndt	H01R 13/2464
				320/115
2016/0307712 A1 *	10/2016	Nishimura	B26B 19/388
2018/0085953 A1 *	3/2018	Perez Lopez	B26B 19/384
2019/0061183 A1 *	2/2019	Neyer	B26B 19/382

2019/0299437 A1 *	10/2019	Fuellgrabe	B26B 19/042
2021/0023729 A1 *	1/2021	Langberg	B26B 19/3873
2021/0268674 A1 *	9/2021	Weschta	B26B 19/146

OTHER PUBLICATIONS

Women Electric Razor, Ribivaul, reviewed on Jul. 8, 2020 on amazon.com, retrieved on Mar. 15, 2022, retrieved from the Internet URL: https://www.amazon.com/Electric-Ribivaul-Floating-Rechargeable-Charging/dp/B08CXZGSNR/ref=sr_1_31?crd=31R4TVGTX3AHM&keywords=women%27s%2Brazor%2Bwith%2Bstand&qid=1647353023&srefix=women.*

* cited by examiner

Primary Examiner — Jennifer Rivard
Assistant Examiner — Alison M Ofstun

(57) **CLAIM**

The ornamental design for a lady shaver, as shown and described.

DESCRIPTION

FIG. 1 is a front, top and left perspective view of a lady shaver showing my new design;
FIG. 2 is a rear, bottom and right perspective view thereof;
FIG. 3 is a front elevation view thereof;
FIG. 4 is a rear elevation view thereof;
FIG. 5 is a left side elevation view thereof;
FIG. 6 is a right side elevation view thereof;
FIG. 7 is a top plan view thereof;
FIG. 8 is a bottom plan view thereof; and,
FIG. 9 is an enlarged view of portion "9" shown in FIG. 1. In the drawings, the broken lines illustrate enlarged view indicators and form no part of the claimed design.

1 Claim, 9 Drawing Sheets

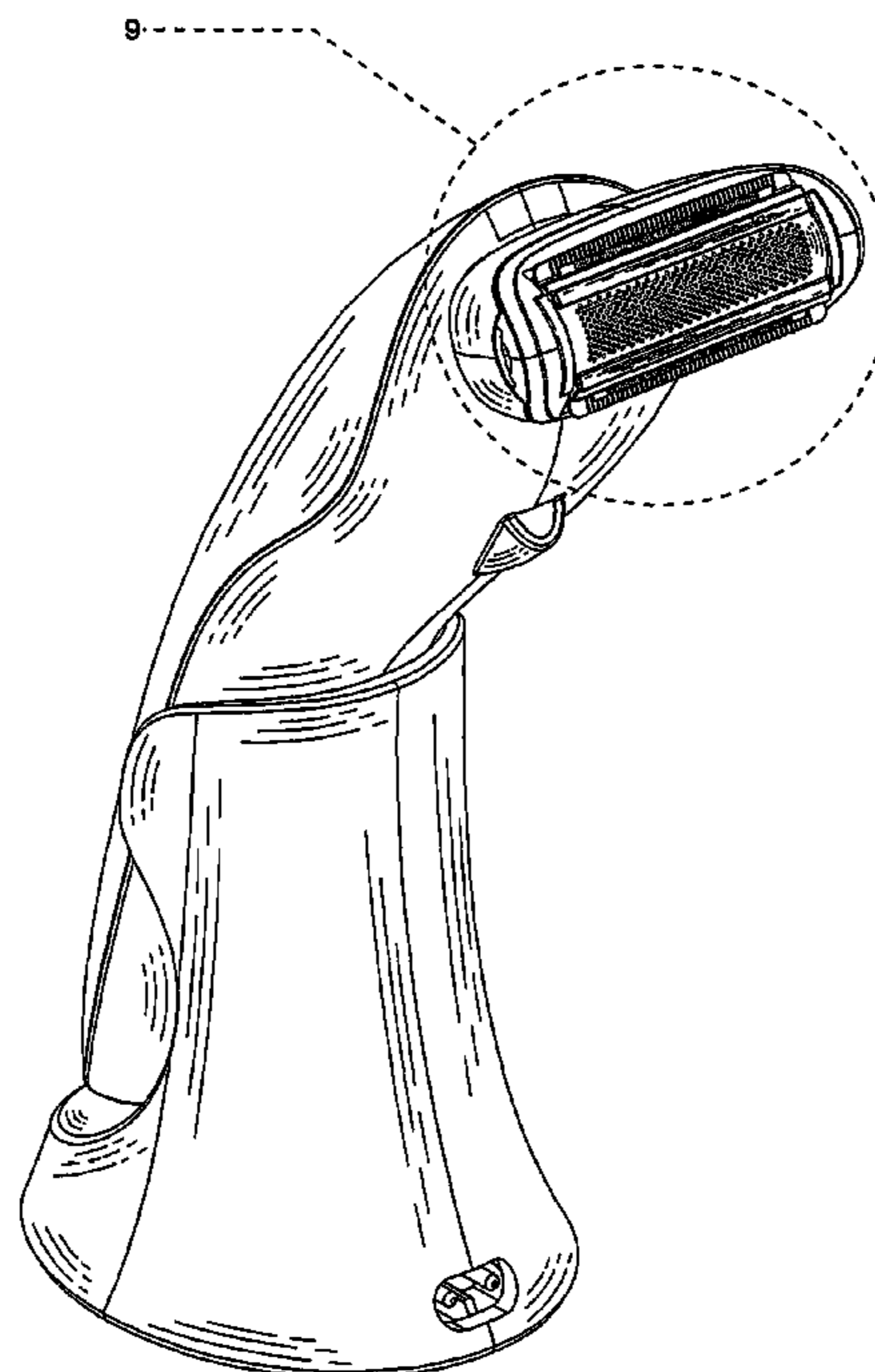

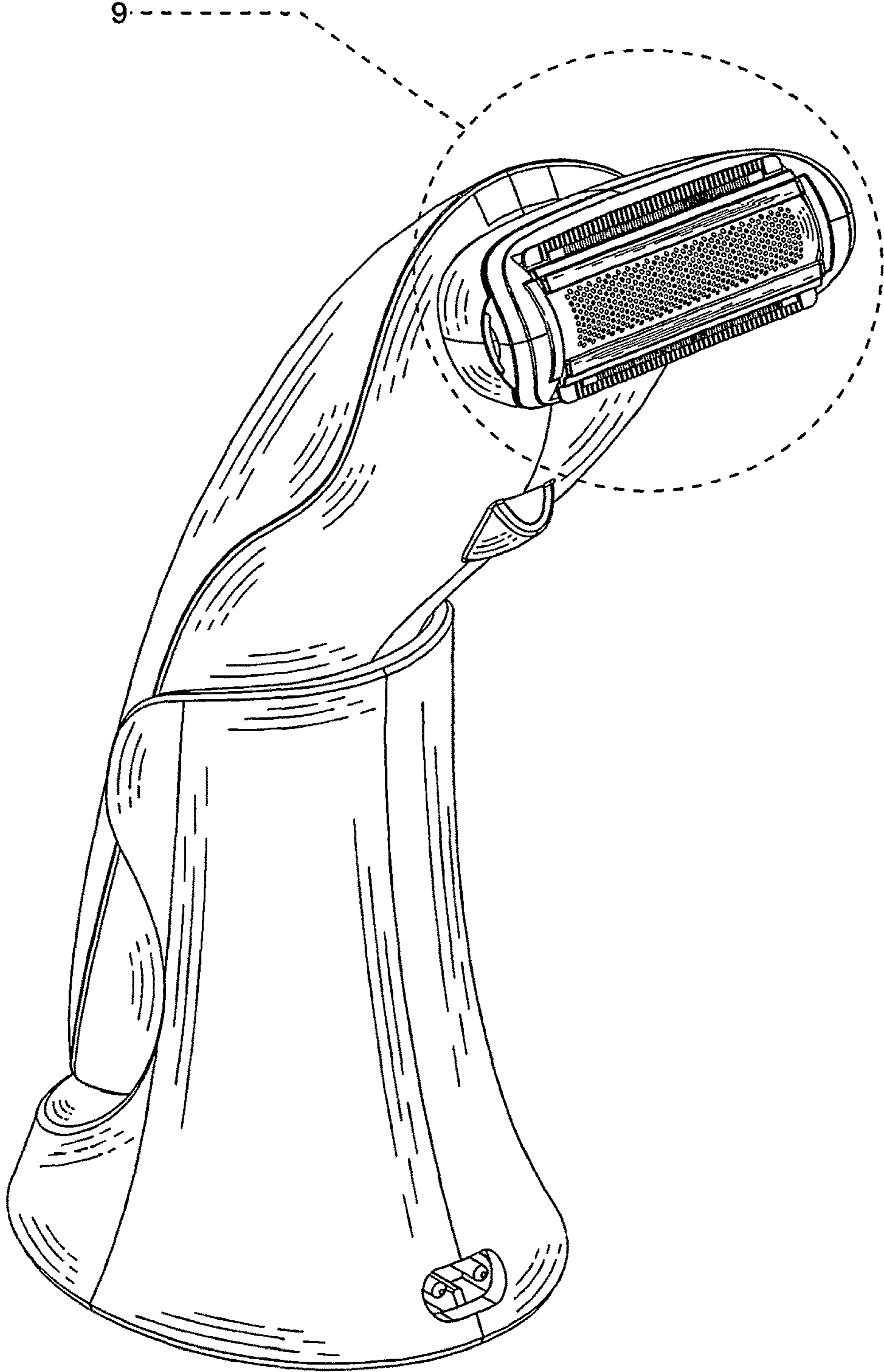

FIG. 1

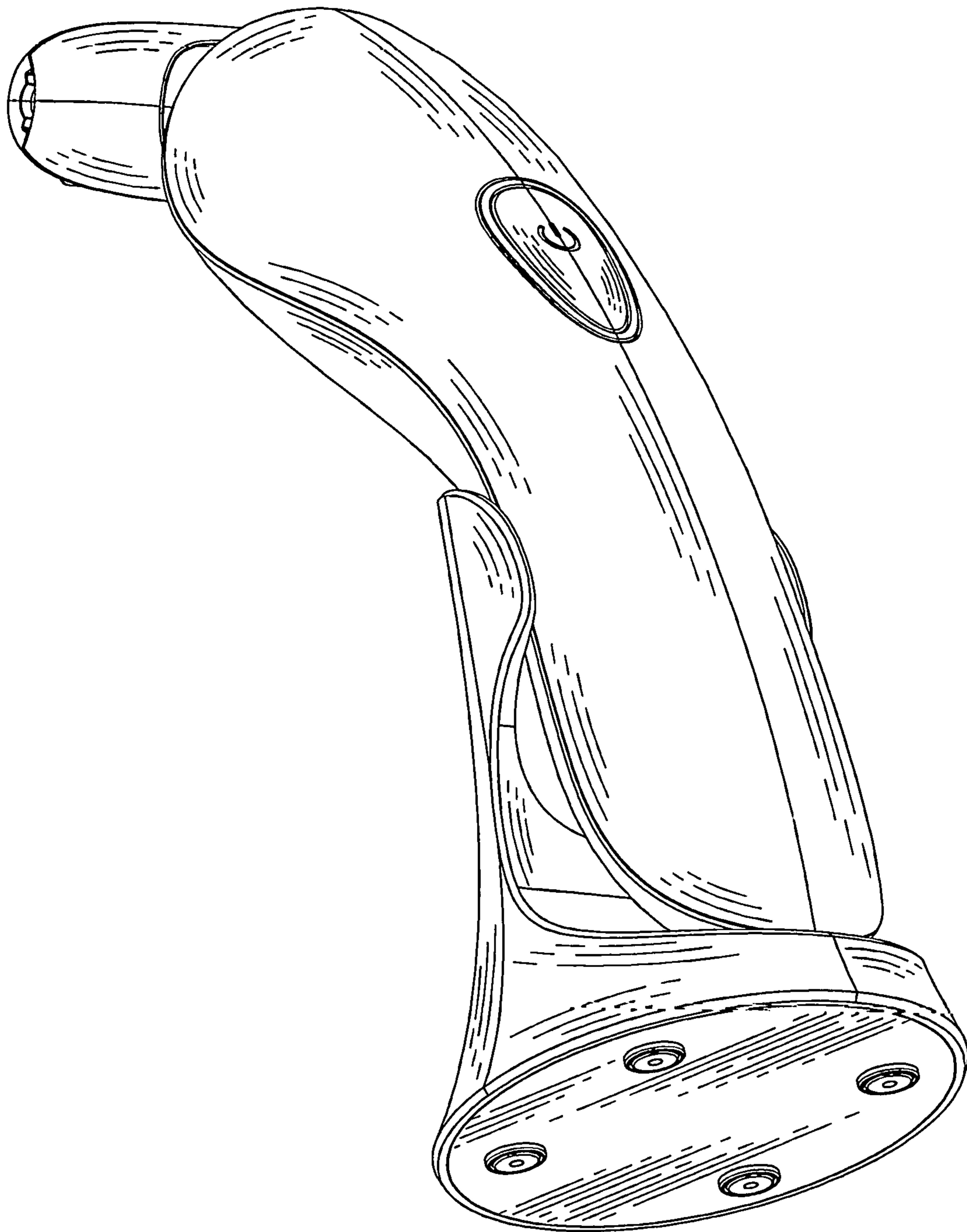

FIG. 2

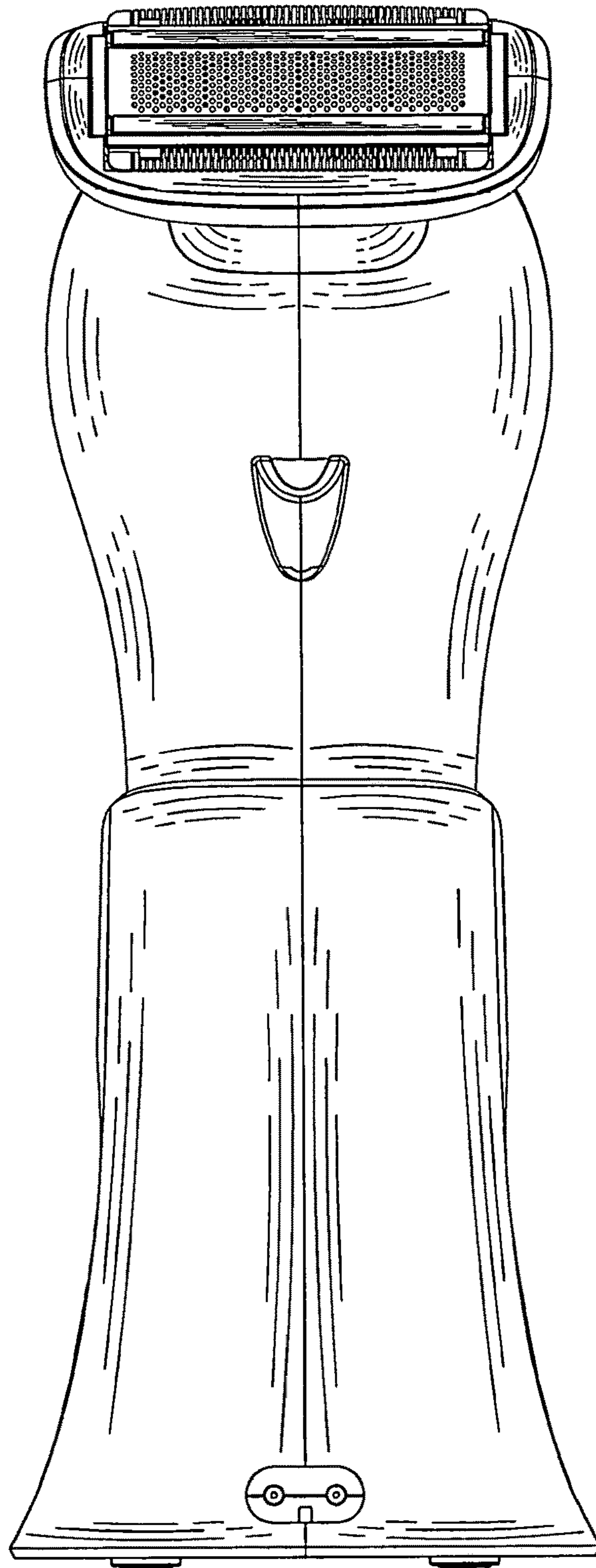

FIG. 3

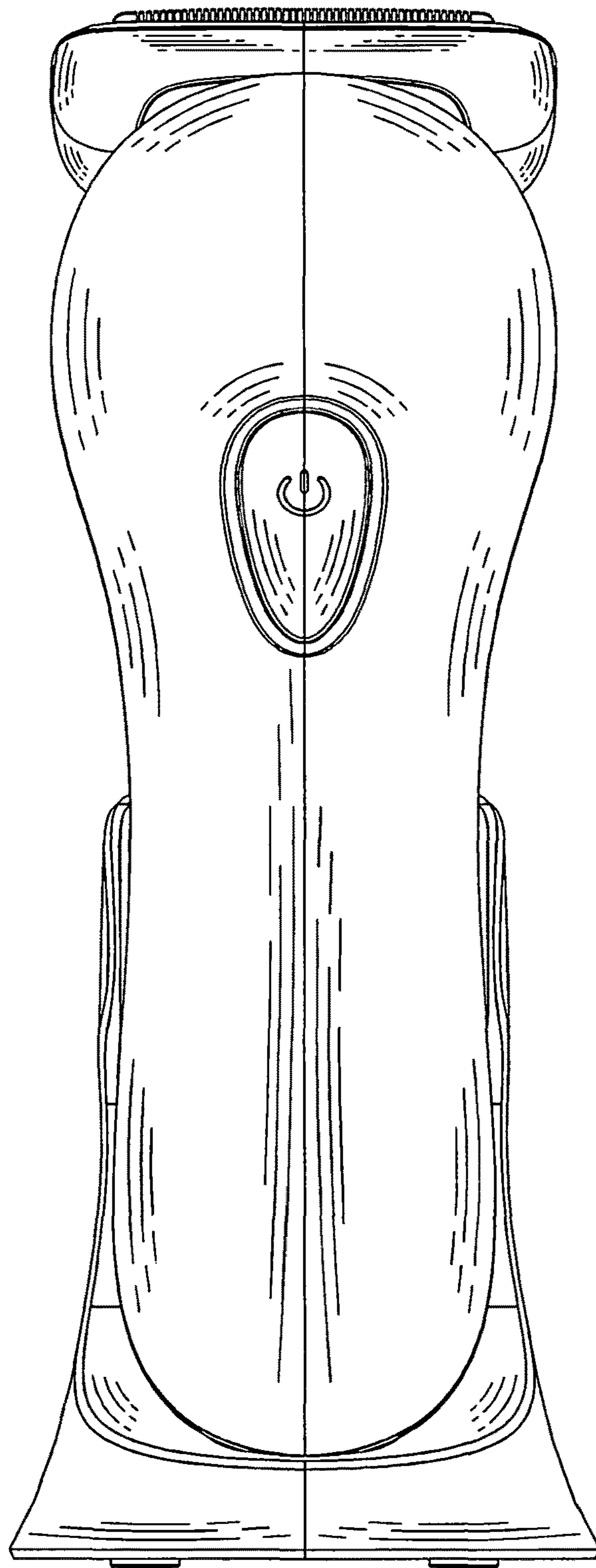

FIG. 4

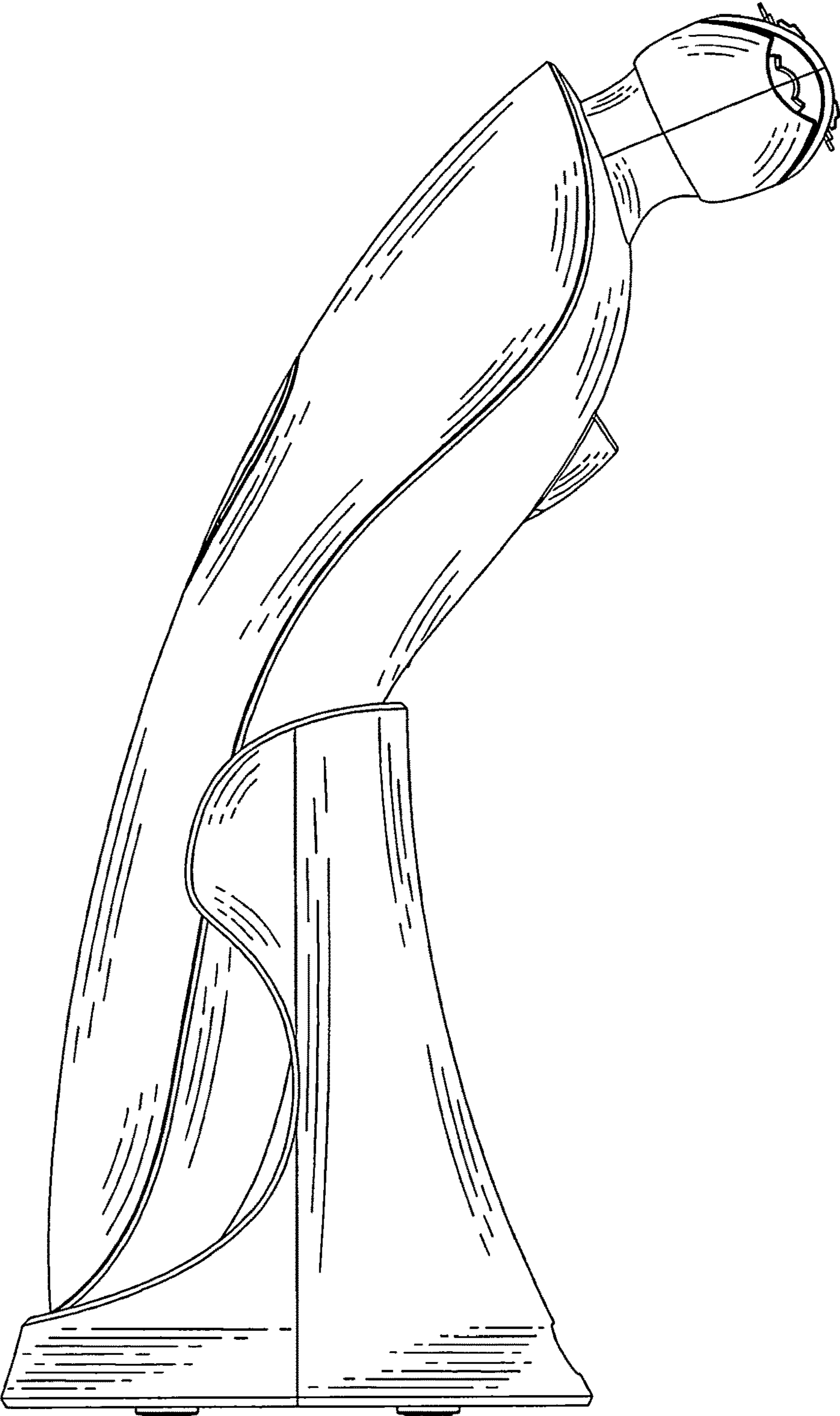

FIG. 5

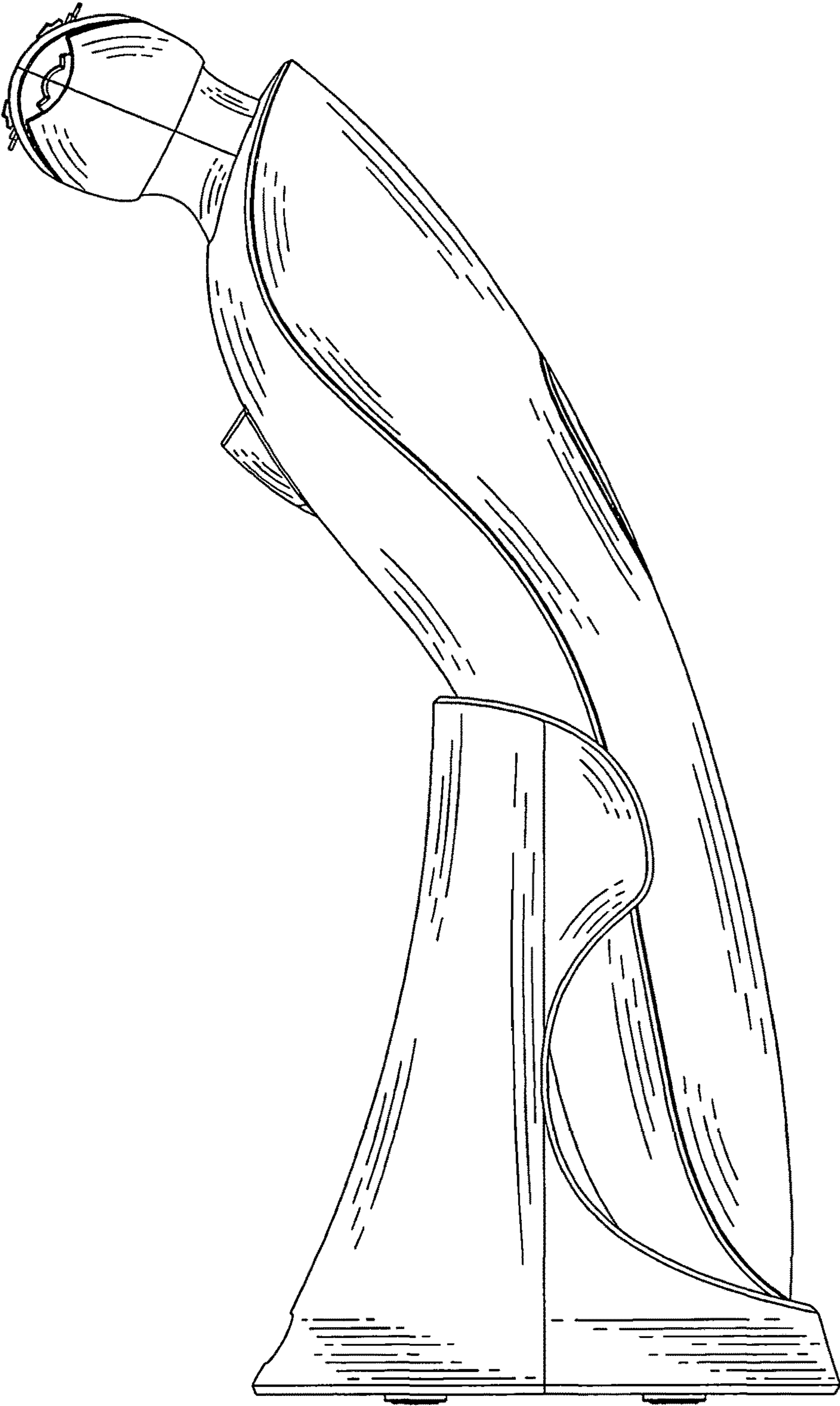

FIG. 6

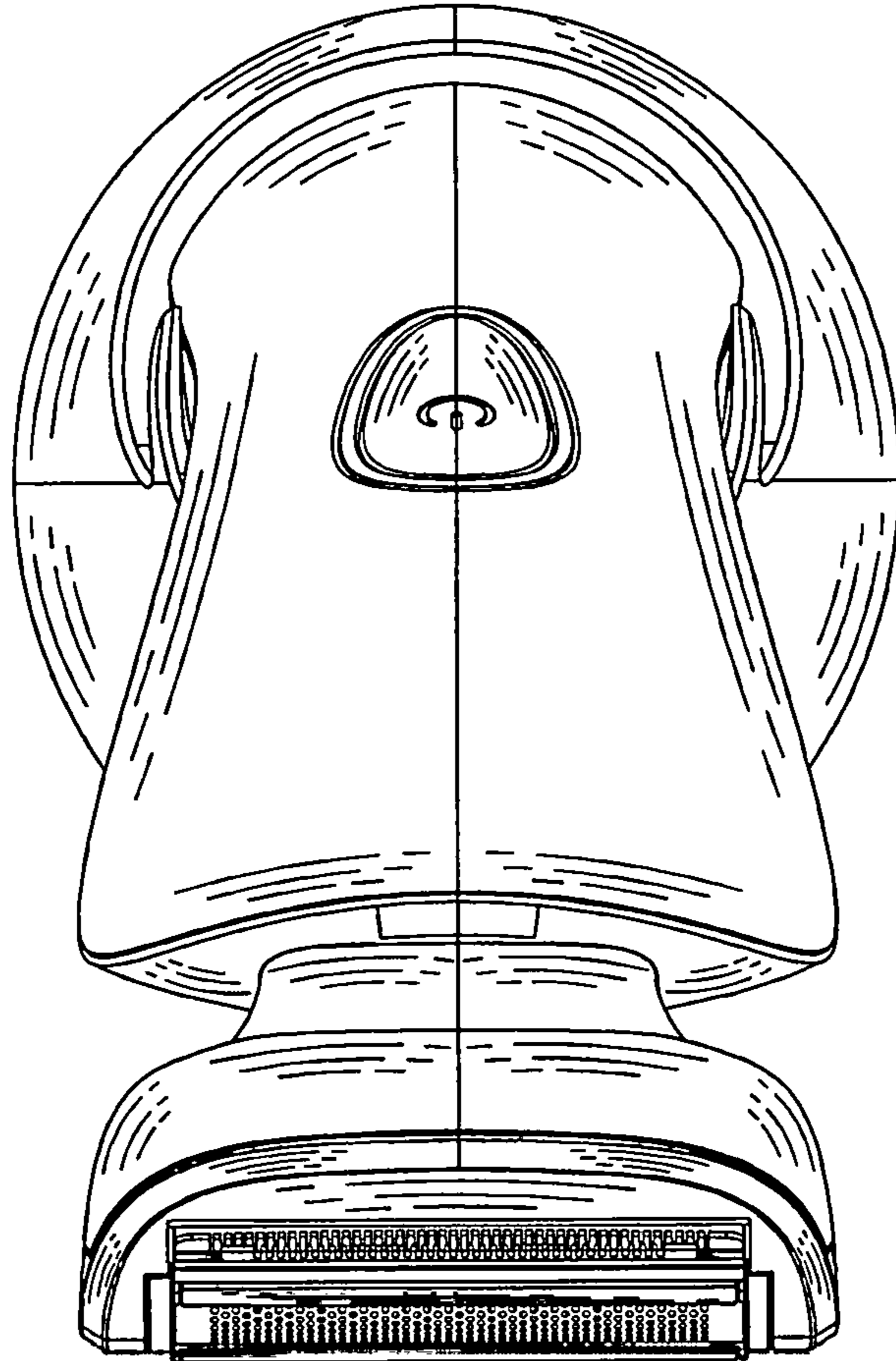

FIG. 7

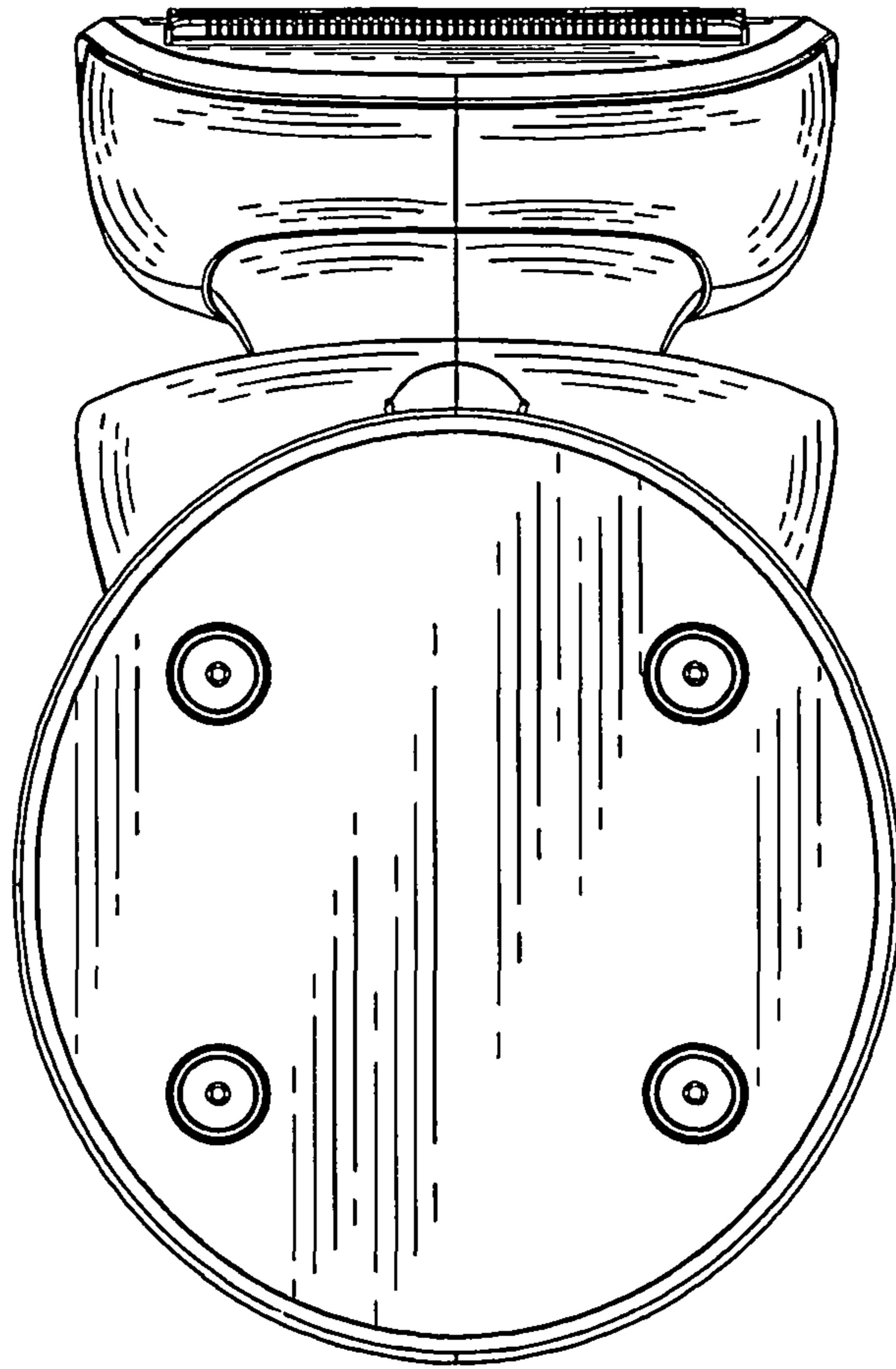

FIG. 8

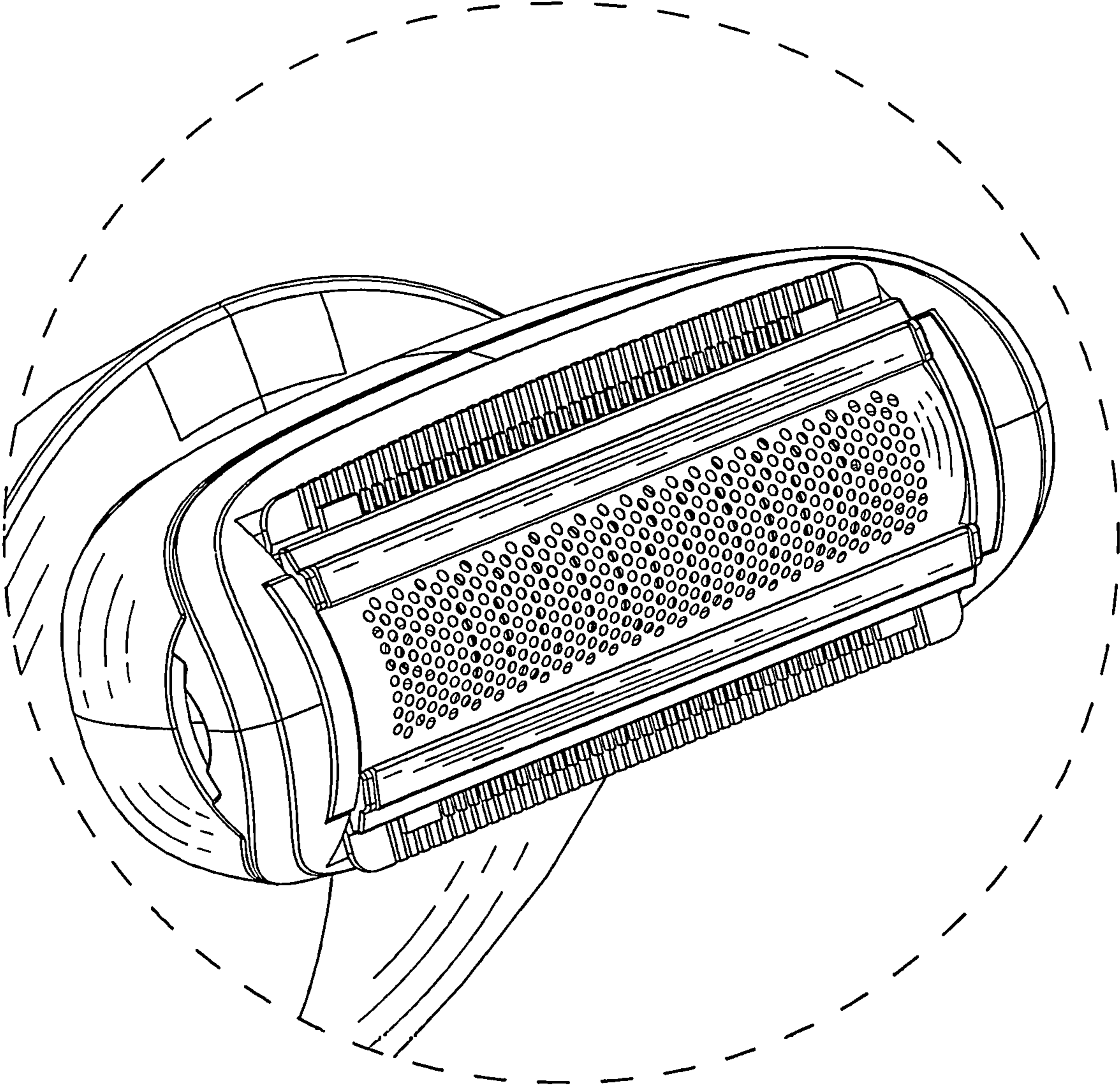

FIG. 9